



Industrial Tools



More Than Productivity

Desoutter Assistant & Digital Twin

All the latest innovations by Desoutter in your pocket.

The application is available on mobiles and tablets, iOS and Android. Download it now and discover all its features, all in your pocket:

- ✔ Discover the full Desoutter catalog and bookmark your tools
- ✔ Talk to Lisa, our chatbot, to find the right accessory for your tool
- ✔ Access all technical data, documentation and product catalogs/leaflets
- ✔ Watch videos presenting our products, our company, or Industry 4.0 topics...
- ✔ Easily send a photo and a message to one of our experts around the world
- ✔ Available in 19 languages

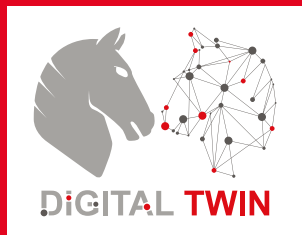

Access 24/7, The Virtual Replica of Your Desoutter Tool

Go to www.desouttertools.com and Enter your tool's Serial Number



- Ⓞ — Compliance & Calibration Certificates
- Ⓞ — Maintenance Time Table
- Ⓞ — Technical Drawings
- Ⓞ — Spare Parts Listing
- Ⓞ — Manuals



Table of Contents

DESOUTTER PRESENTATION	4	CUSTOMIZED SOLUTIONS	145
DESOUTTER SERVICE	10	Specific nutrunners & spindles, Insulated solutions, EPBx HT, EABx HT, Multiplus	145
SELECTION GUIDE - ASSEMBLY TOOLS	14	Arms and torque tubes	152
BATTERY STAND ALONE ASSEMBLY TOOLS	17	Special solutions	154
E-LIT Series - Clutch type	17	Screwfeeder solutions	156
B-FLEX Series - Transducerized	22	TORQUE MEASUREMENT SYSTEMS	158
B-FLEX QRX	26	Delta Data Collector and Analyzer	159
BLRTA	27	DWTA - Digital wrench	162
ELECTRIC ASSEMBLY SYSTEMS	31	DRT, PST, DJS, DSTxs, FCT - Digital rotary, static and pulse transducers	164
CONNECT - Industrial Smart Hub	31	Delta Cart - Calibration	170
QShield-C, Virtual Cable, Sight, EABS, BLRTC, EPBcom, EABcom - Battery nutrunners	38	Alpha - Low torque analyzer	172
CVI3 Controllers	53	QShield-S - Digital wrench - Torque and angle	174
ERP, ERP-HT, EAD, EID, SALTUS - Nutrunners	58	TOOL ACCESSORIES	183
EFD Range - Electric fixtured spindles	70	Reaction arms	184
CVIR II Controllers	87	Telescopic reaction arms	194
ERS - Screwdriver	89	Torque tubes	199
CVIXS - Controller	90	Balancing arms	202
Nano Driver - Low torque screwdrivers	91	Balancers	204
CVIL II Controllers	92	Tool holsters	206
E-PULSE - Electric pulse nutrunners	93	Automatic screw dispenser	207
ERP - Nutrunners	94	SELECTION GUIDE - DRILLING AND RIVETING	209
MultiCVIL II Controllers	95	AUTOMATIC DRILLING UNIT	212
EME, EMEL - Fixtured spindles	97	PNEUMATIC DRILLS AND TAPPERS	226
CVIC II Controllers	101	COMPRESSION TOOLS AND PNEUMATIC RIVETING	240
ECS - Screwdrivers	105	Drills and Tappers	226
ECSF, MC - Fixtured spindles	106	XPB - Battery drill	218
Posco 500 - Positioning system	108	Multi drills	220
DIGITAL EXPERIENCE	76	Angle drills	226
Set your tools right	76	Pistol drills	231
CVI3 & CONNECT Platform - CVI Config, CVI Monitor, CVI Analyser, CVI Key	76	Straight drills	234
E-LIT Platform - E-LIT Config	78	Controlled drilling	235
Other Platform - CVIPC2000	78	Tappers, deburring tool and rivet shaving	236
Quality Control and measurement traceability	79	Rack feed drills	238
Delta Range - Delta QC Licensed, Advanced, Free version	79	Compression tools	240
Live data reporting & traceability	80	Riveting hammers	245
Product features - CVI Net Web	80	SELECTION GUIDE - REMOVAL TOOLS	249
Product references list - CVI Net Web	81	PNEUMATIC GRINDERS / SANDERS	250
PivotWare - Process Control	82	Grinders for carbide burs, mounted points and sanding discs	251
Product features	82	Routers	258
Product references list	84	Grinders for type 1 wheels, cone wheels, depressed center wheels	260
ELECTRIC SCREWDRIVERS	113	Sanders for expandables wheels, flap wheels and abrasive discs	276
ESP1 / ESP2 Controllers	113	Dust extraction systems for grinders and sanders	286
SLBN - Screwdrivers	114	Random orbital sanders, Polishers and Orbital sanders	294
ESP C Controllers	116	Belt sanders	306
SLC - Screwdrivers	117	MISCELLANEOUS TOOLS	308
PNEUMATIC FASTENING TOOLS	121	Saws, Vacuum pen, Vacuum cleaner, Air scribe	309
Shut off - Straight, pistol and angle head screwdrivers	128	AIR LINE ACCESSORIES	311
Non shut off - Straight and pistol screwdrivers	133	Hoses	312
Direct drive - Pistol and angle head screwdrivers	135	Air flex	313
Automatic reverse screwdrivers	136	Fastener Accessories	315
Shut off - Torque controlled	137	SAFETY INSTRUCTIONS	336
PTF - Pulses	142		

Unless specified all inlet threads are BSP or NPT dependent of market

100



YEARS OF INNOVATION

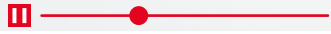

In Desoutter's earliest days one hundred years ago, who would have imagined that it would become today's global leader in its sector? How many industrial companies can claim, like Desoutter, to have weathered the years with such success, never forgetting the values that have formed the foundation of their prosperity?

This one century of existence would not have been possible without that drive for innovation that characterises our company, without that perpetual determination to evolve along with the changing world around us, always acting with vision to anticipate the needs of tomorrow.

This longevity is also the fruit of dedicated devotion on the part of all those employees who have shared their ideas, their skills and their technological expertise in order to turn that thrust for innovation into reality and to give it meaning.

But this history is also - and primarily - that of our customers and partners who remain the sole reason for our existence. It is for them and alongside them that we strive for perfection day after day, and our intention has been to pay tribute to them in the name of this shared success by compiling some of their testimonials in this book.

Together we have written the beginning of a great story. And together we will continue to move forward, to look to the future with the same ambition: always to offer "more than productivity".

1914
 Foundation of Desoutter
 First Duralumin artificial limbs are created

1918
 Foundation of Georges Renault
 Spare parts for portable pneumatic tools are manufactured

1930
 First flight of the Desoutter Mk. I

1960
 Patents approved for torque controlled angle wrench

1977
 Scan Rotor is founded
SCANROTOR

1990
 First models of Georges Renault transducerized tools:
 SE hand held tools with the Case 40 controllers





Order book P.N. 615 993 957 0

Find more on what customers tell about their Desoutter's customer experience in the **Desoutter's anniversary book!**

2004
Creation of
PIVOTWARE
Advanced
Process Control



2005
Creation of
SETITEC
Advanced Drilling
Units



2012
E-Pulse low torque
reaction Electric
tool



2018
CONNECT
Industrial
Smart Hub



Desoutter
Assistant



EABS
One Hand
Nutrunner

2020
Digital Twin



DIGITAL TWIN

Virtual Cable



MULTI and
EFDO

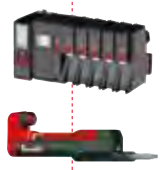

XPB
Smart
Drilling



End
Effector

DE METER





DESOUTTER 4.0

Accelerate your transformation



DESOUTTER 4.0

Intelligent assembly solutions

- Production ready!
- Augmented assistance
- Ergonomic product
- Safety
- Paperless solution
- Work instructions guidance
- Industrial Smart Hub

The increasing digitalization of the manufacturing sector means the era of the smart factory is now upon us. The fitting of myriad equipment with sensors, and the ability to collect, transmit and interpret data in real-time, is leading to previously unattainable levels of traceability and control. That is enabling tools, machines and people to communicate like never before. This trend, commonly referred to as Industry 4.0, is giving companies far better visibility of their industrial processes, ensuring that potential problems can be identified before they occur.



Here at Desoutter, we are committed to turning Industry 4.0 into products and services that deliver maximum benefit to our customers and partners. From reduced downtimes, to more flexible production processes with lower costs, Industry 4.0 has the potential to transform the ways organizations perform.

So you can concentrate on your core your assembly expert is here !

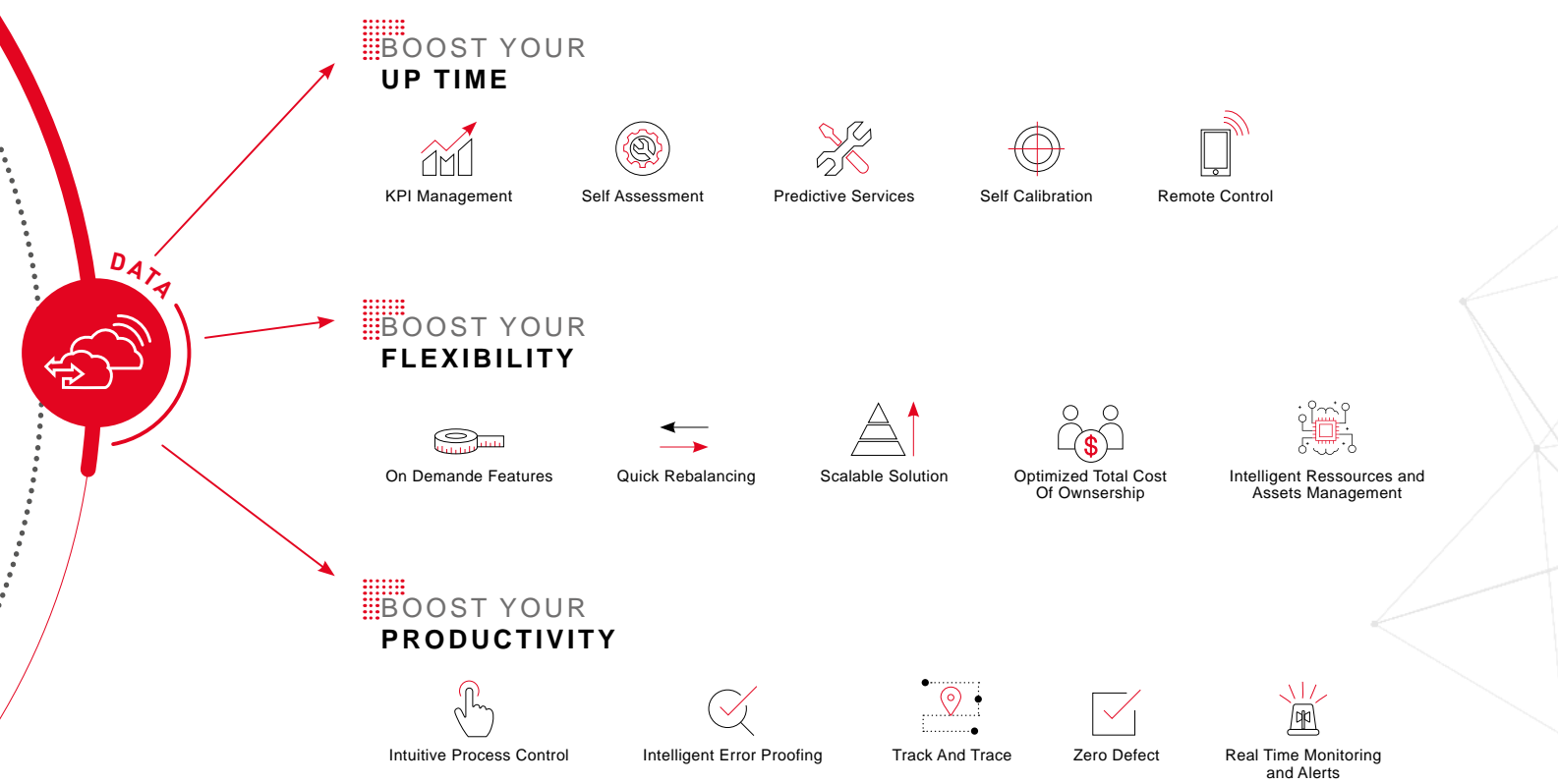

More Than Productivity



Desoutter is your single source of electric and pneumatic tool solutions,

covering a wide range of assembly and manufacturing processes in the motor vehicle, aerospace, general industry and light assembly sectors.

Desoutter has a long history of producing high-quality industrial tools. Today, the scope of the activity combines a global offering with a widespread local presence.

The reason behind this approach is simple: our customers, who include many of the world's largest and most successful manufacturers, want worldwide access to a global portfolio of assembly and manufacturing solutions.

With Desoutter, we provide you more than productivity.



FOCUSED ON YOUR OBJECTIVES...

Industry hates risk. And so do we. So we work with you to eliminate cost, quality and performance risks from your production lines.

Optimize your investments

Your production lines are some of your company's most important investments. The quality and performance of Desoutter industrial tool solutions enable you to optimize your return on investments by producing more in the same cycle time. Our airline systems, for instance, keep our pneumatic nutrunners spinning at exactly the right speed and power, saving you precious seconds for each operation.

Raise productivity

Good ergonomics makes good economic sense. Not only are Desoutter tools designed to reduce operator stress factors, such as vibration and noise, they also take into account the relationship between the operator, the tool and the process. Our experts work with you to obtain long-term gains in productivity and safety, while improving cost, quality and cycle times.



GLOBAL SOLUTIONS YOU CAN BUILD ON...

We know that finding the best solution is about much more than just picking a new tool. That is why we start every project by opening our ears, not our catalog.

Process optimization

Producing high-quality products requires high-quality processes. That is why many of the world's major motor vehicle, aerospace and appliance manufacturers rely on Desoutter. Each Desoutter solution is tailored to your exact needs. Our experts propose solutions that deliver a quantifiable return on investment, whether in terms of productivity improvements, quality gains or safety improvements.

Worldwide coverage

Desoutter combines global reach with local expertise. To ensure the smooth running of Desoutter solutions in your factories, all our local teams are trained to the same high level of expertise and service. Each team is in direct contact with the Desoutter area application and customer care center for your region. Together they ensure that solutions are implemented to worldwide standards, but in compliance with local criteria.





EXPERTISE YOU CAN GROW ON...

From motors vehicles to appliances, planes to construction machines, electronics to energy – there is a Desoutter air powered and electric tool solution for you.

Covering all segments

Motor vehicle industry

A wide range of tool solutions for vehicle makers, tier one suppliers and linebuilders. Solutions include fixed systems for powertrain assembly and handheld solutions for final assembly processes.

Aerospace

A long history of providing tools solutions to aerospace companies. We cover a wide range of their needs, from airframe and engine construction to system assembly.

Customized solutions

Our Applications Centers are the symbol of our renowned flexibility. As comprehensive as our catalog is, we know that sometimes you need a tailored solution. Our Application Center engineers adapt existing solutions to your requirements and develop your own solutions. They are experts at developing Six Sigma tools and error proofing.



A PARTNER YOU CAN COUNT ON...

Our support services keep your processes operating at maximum levels – and leave you to focus on your core business.

Genuine Desoutter parts

Genuine Desoutter parts are the only parts designed and engineered specifically for Desoutter tools. They ensure that our tools always operate at their best. Moreover, for a lifetime of satisfaction, we always use genuine Desoutter spare parts when performing maintenance and repairs.

Proactive logistics

When your operations are global, it is essential that your logistics are too. Our centralized inventory and warehousing system is highly responsive. We proactively manage our production to ensure a reliable supply of the products and parts you need. The majority of the solutions in our catalog can be shipped to you in three days, no matter where you are located. Next-day service is available in many markets.



Why Service is important for you !

Service boosts your production **UPTIME, COST EFFICIENT MAINTENANCE, QUALITY WITH HIGH PRODUCTIVITY.**

A proactive service plan:

- ☑ Reduces unplanned stoppages and disruptions on the production line.
- ☑ Ensures tool accuracy, so quality is maintained.
- ☑ Reduces production rework costs.
- ☑ Extends tool life.
- ☑ Reduces day to day administration and repair costs.

Here is the Desoutter Service offer to support you with all products of this catalogue:

 SMART START	 TOOL CARE	 SOFTWARE SUPPORT	 PRODUCTION BOOST
○ INSTALL & SET UP	○ SERVICE PLANS & PARTS REPAIR	○ REMOTE EXPERTS	○ ON-DEMAND SERVICES

We built this offer to meet your needs on your business key drivers.



Improved uptime



Lower maintenance costs



Quality with high productivity

Discover the value of proactive Service by Desoutter.

Desoutter Service



Smart Start / Install & set up



Start-up

A professional, high quality installation adds value.

Benefits

- ☑ Fast and right first time.
- ☑ Avoids delays & minimises risks.
- ☑ Maintains warranty.
- ☑ Ensures tool accuracy and ergonomics.
- ☑ Full support from start to finish from certified technicians.



Performance Validation

Detect issues that cannot be identified during the Start-up phase.

Benefits

- ☑ Optimises tool settings to further improve productivity.
- ☑ Detects missing or incorrect components.
- ☑ Detects need for operator training.
- ☑ Helps further reduce cost and increases quality.



Consists of 4 steps



Desoutter Service



Tool Care / Service Plans

	Preventive maintenance labour	Preventive maintenance wear out spare parts	Calibration	Repair at Desoutter Workshop	Repair spare parts included	Optimised preventive maintenance	On-site Repairs	Maintenance KPIs	On-site production support
 Basic Care	✓	✓	✓						
 Smart Care	✓	✓	✓	✓	✓	✓			
 Peace of Mind	✓	✓	✓	✓	✓	✓	✓	✓	✓

Production uptime is key for your business

- ✓ Preventive Maintenance reduces the production stops due to breakdowns and NOK's.
- ✓ On-site support also reduces disruptions.

You think your maintenance costs are too high

- ✓ Preventive maintenance decreases the costs of breakdowns.
- ✓ The lifetime of your tools is extended.

You want to keep the best quality with high productivity

- ✓ Preventive maintenance ensures tool accuracy and reduces rework.
- ✓ Operator coaching by Desoutter technicians results in less NOK's and therefore even less rework.



Tool Care / Calibration

Calibration is key to get a safe and traceable tightening process

- ✓ Less rework.
- ✓ Reduced risk of false OK results.
- ✓ Fulfilment of ISO requirements.
- ✓ Providing proof in case of liability issues.



Tool Care / Parts & Repair



Service Link

- ✓ Designed as a Search Assistant.
- ✓ Intuitive navigation.
- ✓ Simplified order process.
- ✓ Data download.



Smart Repair

You expect fast turnaround time and reliable repairs.

- ✓ Smart Repair is an efficient repair process.
- ✓ Our Technicians only use genuine spare parts.



Desoutter Service



Software Support / Remote experts

With great products, comes great responsibilities!

Software and support together as one overall offer to get the most of our powerful Desoutter software.



Build with experts , Essential Care is a remote support portal **CONNECTED** and **ONLINE**. Ask an access to the Support portal **NOW!**



Get more details about digital experience software and services



SOFTWARE
see page 82



Production Boost / On-demand Services

Are you looking for even more?



On-site Technician

- ☑ Supports you with solving issues.
- ☑ Assists in identifying process improvement opportunities.



Certification Training

- ☑ Develops your technician's knowledge on troubleshooting and assembly techniques.
- ☑ It improves interaction with our Desoutter technicians.



Performance validation

- ☑ Identifies improvement opportunities.
- ☑ Detects issues before they affect production.

Assembly Tools - Selection guide

PAGE	TOOL TYPE
17-28	BATTERY STAND ALONE ASSEMBLY TOOLS 
31-51	INDUSTRIAL SMART HUB & WIRELESS TRANSDUCERIZED BATTERY TOOLS 
53-75	ELECTRIC TRANSDUCERIZED DC TOOLS & NUTRUNNERS 
76-85	DIGITAL EXPERIENCE - CVI Config / CVI Monitor / CVI Analyzer / CVI Key / E-LIT Config / Delta QC / CVI Net Web / Pivotware
87-99	ELECTRIC TRANSDUCERIZED DC TOOLS - PC & Networks/Software - CVIR II / MULTICVIL II / CVIL II / CVIXS 
101-111	ELECTRIC CURRENT CONTROLLED DC TOOLS - CVIC / POSCO 
113-119	ELECTRIC FASTENING TOOLS 
121-143	PNEUMATIC FASTENING TOOLS 
145-157	CUSTOMIZED SOLUTIONS: ExBx HT - Screwfeeders - Multiplus - Arms 
158-180	TORQUE MEASUREMENT SYSTEMS 

Advanced tightening systems

ELECTRIC TRANSDUCER CORDLESS



ELECTRIC TRANSDUCER CORD

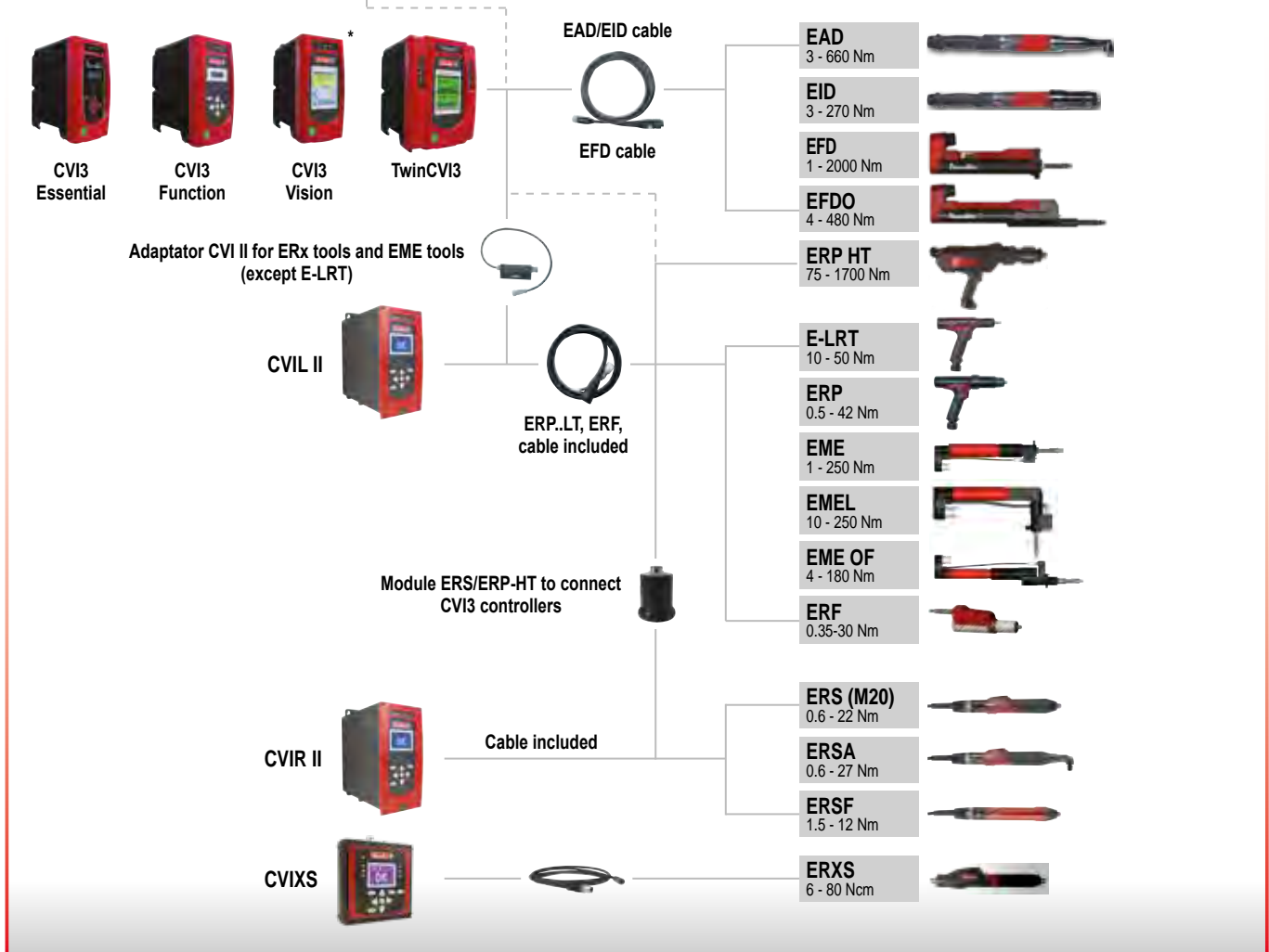

ELECTRIC CURRENT CONTROL

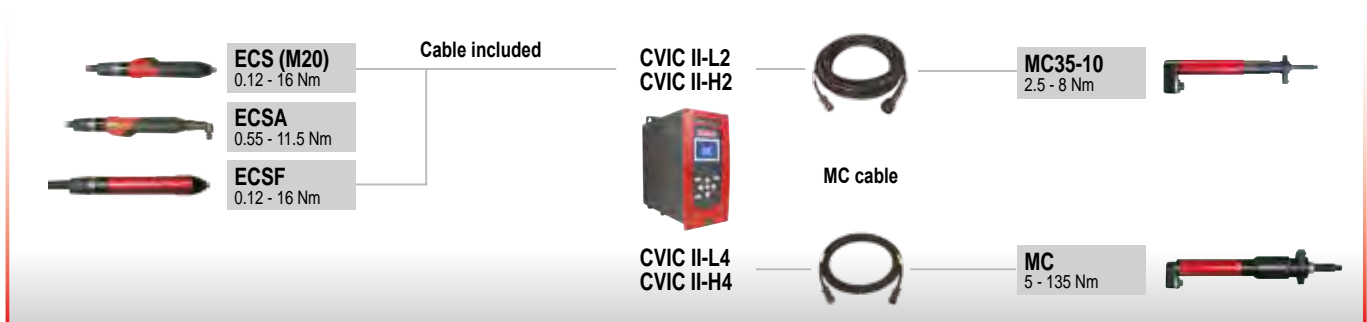











E-LIT Series - Optimize your performance

Clutch Battery Tool range

FOCUS



3 MODELS TO CHOOSE FROM	 BRUSHLESS MOTOR	 LI-ION BATTERY	 E-LIT CONFIG SOFTWARE	 SPEED MODULE	 CONNECT
E-LIT PLUS ELECTRONIC BRUSHLESS (ELB) PISTOL 	✓	✓	✓		
E-LIT PREMIUM ELECTRONIC BRUSHLESS SPEED CONTROL (ELS) PISTOL AND ANGLE 	✓	✓	✓	✓	
E-LIT WIRELESS COMMUNICATION (ELC) PISTOL AND ANGLE 	✓	✓	✓	✓	✓

Tool management device

Speed setting / For ELS and ELC models

Two speed setting easily controlled by external module



Everything needed to optimize your assembly process

Guarantee quality and keep high productivity

- Decrease final speed to ensure tightening quality
- Avoid quality defects in your final product
- Decrease starting speed to facilitate bolt engagement

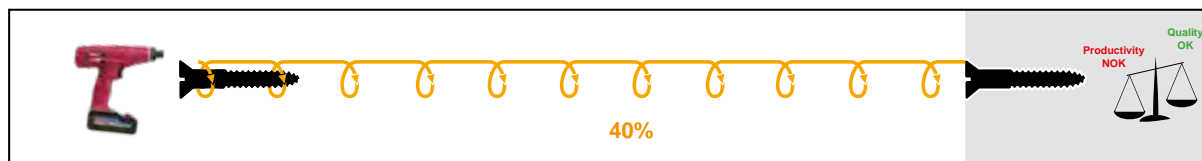
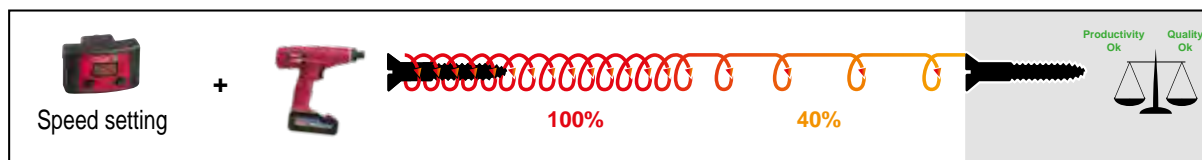

E-LIT CONFIG software



SOFTWARE
see page 78



E-LIT Series - Optimize your performance

Clutch Battery Tool range

Focus on wireless clutch tool solution

TU E-LIT WIFI proposes a better production follow-up , a better error proofing and a better total cost of owner ship of your production line by integrating and controlling a clutch tool on the CONNECT platform.



BETTER CONTROL OF PRODUCTION LINE

by enable or disable clutch tool

PRODUCTION QUALITY IMPROVEMENT

with traceability on standard joint

EASY INTEGRATION

thanks to CONNECT platform connectivity

Enable/disable tool

according to production process:

- Batch count
- Reverse mode
- Open protocol, I/Os & Field bus



OK/NOK reports

and prevent from FALSE OK:

- OK/NOK
- Re-hit
- Cross thread prevention



Setting adjustments

To fit with application requirements

- Up to 3 speeds
- 4 Pset & 4 Assembly Process
- Batch count

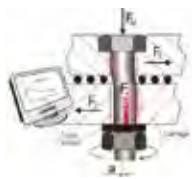

Traceability information

For a better follow-up and analysis

- Results linked with a VIN NUMBER
- Lock tool when memory is full (option)
- CVI MONITOR, ANALYZER & NET WEB compatible



FOCUS ON ERROR PROOFING FEATURE CROSS THREAD PREVENTION

A clutch could shuts off even if the screw is not well seated due to higher resistance linked to cross thread situation

TU E-LIT WIFI is now able to detect a cross thread situation and report a NOK in your traceability system



FOCUS ON PRODUCTION CONTROL FEATURE BATCH COUNT

More production takt time is high or more production process is complex, more the risk to miss a screw is high !

**Batch count
real time feed-back**



Avoid quality issues and reduce rework time with batch count functionality

Accessories

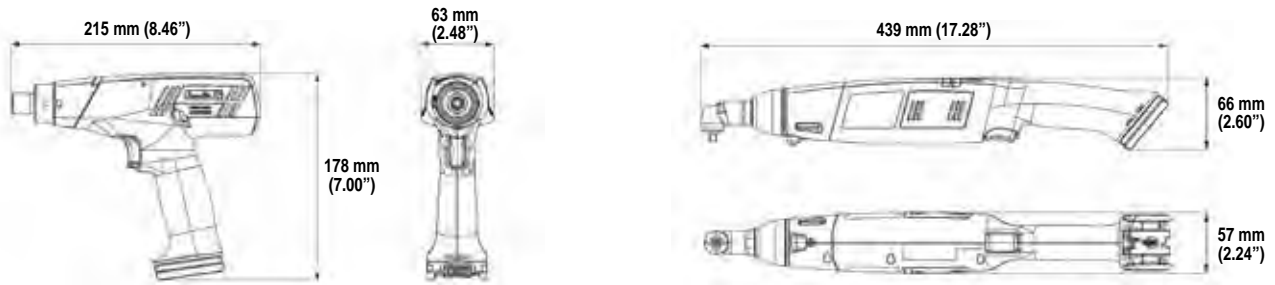

OPTIONAL ACCESSORIES

ITEM		PISTOL	ANGLE HEAD 18V	ANGLE HEAD 36V	ELC -W TOOLS	PART NO.
Battery type						
1	Li-ion battery pack 18V 2.5 Ah - 0.46 kg (1,01lb)	✓	✓		✓	615 813 266 0
2	Li-ion battery pack 36V 2.5 Ah - 0,77 kg (1,70lb)	✓		✓	✓	615 813 267 0
Chargers						
3	Charger Universal 18 / 36V	✓	✓	✓	✓	615 813 270 0
•	Power Cord C13-C14 L=0.3m (daisy chain cable)	✓	✓	✓	✓	615 813 383 0
Protective covers - Tools						
4	For Pistol - Clear	✓			✓	615 396 870 0
4	For Pistol - Black	✓			✓	615 211 030 0
4	For Pistol - Blue	✓			✓	615 211 031 0
4	For Pistol - Red	✓			✓	615 211 032 0
4	For Pistol - Grey	✓			✓	615 211 033 0
4	For Body angle head - Black		✓	✓	✓	615 211 004 0
4	For Body angle head - Blue		✓	✓	✓	615 211 025 0
4	For Body angle head - Red		✓	✓	✓	615 211 026 0
4	For Body angle head - Grey		✓	✓	✓	615 211 027 0
5	For Angle < 15Nm - Black		✓		✓	615 397 672 0
5	For Angle 30Nm - Black			✓	✓	615 573 214 0
5	For Angle 45Nm - Black			✓	✓	615 573 215 0
5	For Angle 60Nm - Black			✓	✓	615 211 005 0
Protective covers - Battery						
6	For Battery 18V 2.5Ah - Clear	✓	✓		✓	615 211 136 0
6	For Battery 18V 2.5Ah - Black	✓	✓		✓	615 211 137 0
6	For Battery 18V 2.5Ah - Red	✓	✓		✓	615 211 138 0
6	For Battery 18V 2.5Ah - Grey	✓	✓		✓	615 211 139 0
6	For Battery 36V 2.5Ah - Clear	✓	✓	✓	✓	615 211 140 0
6	For Battery 36V 2.5Ah - Black	✓	✓	✓	✓	615 211 141 0
6	For Battery 36V 2.5Ah - Red	✓	✓	✓	✓	615 211 142 0
6	For Battery 36V 2.5Ah - Grey	✓	✓	✓	✓	615 211 143 0
Miscellaneous						
•	Kit Overmould Presto (x10 pcs)					615 211 057 5
7	Speed Setting Module (ELS/ELC version)	✓	✓	✓	✓	615 396 829 0
8	Side handle - Pistol	✓			✓	615 396 757 0
9	Suspension bail - Pistol	✓			✓	443 703
10	Kit colour rings - Pistol (7 colors: white, yellow, orange, green, blue, purple, grey)	✓			✓	615 396 742 5
10	Kit colour rings - Angle tools (8 colors: white, yellow, orange, green, blue, purple, grey, black)		✓	✓	✓	615 970 114 5
11	Kit Nose Crowfoot	✓			✓	615 810 695 0
12	eDOCK + Battery data interface	✓	✓	✓	✓	615 813 400 0
•	E-LIT CONFIG software	✓	✓	✓	✓	-
•	CVI CONFIG software	✓	✓	✓	✓	-
Desouter Tool Holsters						
13	DTH-42	✓			✓	107892
14	DTH-90	✓			✓	615 812 119 0
15	DTH TWIN (single) without rail		✓	✓	✓	615 811 411 0
16	DTH TWIN rail kit with 2 Twin holders		✓	✓	✓	615 811 412 5
17	DTH TWIN stand kit with 2 Twin holders		✓	✓	✓	615 811 413 5



E-LIT series

0.4 to 60 Nm (3.5 to 530 in. lb) - 50 to 1550 rpm



A



B



C



D

PIC REF	MODEL	PART NUMBER	TORQUE RANGE		ROTATIONAL SPEED	OUTPUT DRIVE	WEIGHT WITHOUT BATTERY		VOLTAGE
			Nm	in. lb			kg	lb	

E-LIT PLUS - ELECTRONIC BRUSHLESS MOTOR

A	ELB 2.5-1250-P	615 165 415 0	0.4-2.5	3.5-22	1250	Hex. 1/4 F	0.8	1.76	18
A	ELB 6-900-P	615 165 416 0	0.8-6	7.1-53	900	Hex. 1/4 F	0.8	1.76	18
A	ELB 6-670-P	615 165 440 0	0.8-6	7.1-53	670	Hex. 1/4 F	0.8	1.76	18
A	ELB 8-670-P	615 165 417 0	1.5-8	13.3-70	670	Hex. 1/4 F	0.8	1.76	18
A	ELB 12-600-P	615 165 418 0	3-12	26.5-106	570	Hex. 1/4 F	0.8	1.76	18

E-LIT PREMIUM - ELECTRONIC BRUSHLESS SPEED SETTING

A	ELS 2.5-1550-P	615 165 419 0	0.4-2.5	3.5-22	500-1550	Hex. 1/4 F	0.8	1.76	18
A	ELS 6-1000-P	615 165 420 0	0.8-6	7.1-53	300-1000	Hex. 1/4 F	0.8	1.76	18
A	ELS 8-400-P	615 165 605 0	1.5-8	13.3-70	120-400	Hex. 1/4 F	0.8	1.76	18
A	ELS 8-800-P	615 165 421 0	1.5-8	13.3-70	300-765	Hex. 1/4 F	0.8	1.76	18
A	ELS 8-400-P4S	615 165 825 0	1.5-8	13.3-70	120-400	Sq. 1/4	0.8	1.76	18
A	ELS 12-600-P	615 165 422 0	3-12	26.5-106	250-570	Hex. 1/4 F	0.8	1.76	18
A	ELS 12-400-P4S	615 165 826 0	3-12	26.5-106	120-400	Sq. 1/4	0.8	1.76	18
B	ELS 7-360-A4S	615 165 725 0	1.5-7	13.3-62	120-360	Sq. 1/4	1.2	2.6	18
B	ELS 7-880-A	615 165 628 0	1.5-7	13.3-62	400-880	Hex. 1/4 F	1.2	2.6	18
B	ELS 7-880-A10S	615 165 888 0	1.5-7	13.3-62	400-880	Sq. 3/8	1.2	2.6	18
B	ELS 15-480-A	615 165 629 0	5-15	44.2-133	200-480	Sq. 3/8	1.2	2.6	18
B	ELS 15-480-A4S	615 165 839 0	5-15	44.2-133	200-480	Sq. 1/4	1.2	2.6	18
C	ELS 30-300-A	615 165 630 0	10-30	88.5-265	100-300	Sq. 3/8	1.5	3.3	36
C	ELS 45-180-A	615 165 631 0	20-45	177-398	50-180	Sq. 3/8	1.5	3.3	36
D	ELS 60-160-A	615 165 632 0	25-60	220-530	50-160	Sq. 1/2	1.97	4.33	36

E-LIT WIRELESS - COMMUNICATION

A	ELC 6-1000-P-W	615 166 100 0	0.8-6	7.1-53	300-1000	Hex. 1/4 F	0.9	1.76	18
A	ELC 8-400-P-W	615 166 101 0	1.5-8	13.3-70	120-400	Hex. 1/4 F	0.9	1.76	18
A	ELC 8-800-P-W	615 166 102 0	1.5-8	13.3-70	300-765	Hex. 1/4 F	0.9	1.76	18
A	ELC 12-600-P-W	615 166 103 0	3-12	26.5-106	250-570	Hex. 1/4 F	0.9	1.76	18
B	ELC7-360-A4S-W	615 166 104 0	3-7	13.3-62	120-360	Sq. 1/4	1.2	2.6	18
B	ELC7-880-A-W	615 166 105 0	3-7	13.3-62	400-880	Hex. 1/4 F	1.2	2.6	18
B	ELC15-480-A-W	615 166 106 0	5-15	44.2-133	200-480	Sq. 3/8	1.2	2.6	18
C	ELC30-300-A-W	615 166 107 0	10-30	88.5-265	100-300	Sq. 3/8	1.5	3.3	36
C	ELC45-180-A-W	615 166 108 0	20-45	177-398	50-180	Sq. 3/8	1.5	3.3	36
D	ELC60-160-A-W	615 166 109 0	25-60	220-530	50-160	Sq. 1/2	2	4.3	36

• Battery not included in standard offering

B-FLEX: Performance and flexibility

FOCUS



KEYPOINTS

BEST ERGONOMICS	HIGH TECHNOLOGY	QUALITY CONTROL
Ergostop technology to avoid RSI (Repetitive Strain Injury)	Smart embedded HMI on tool	Direct feedback for the operator
Perfectly balanced grip design	High resolution transducer	Visible tightening results on tool HMI
Rebalancing with the two different battery positions	New motor dedicated to battery tools : high speed, high torque, low temperature	Torque control and angle monitoring
Operator comfort		

B-FLEX: Ergonomy and control

ERROR PROOF QUALITY CONTROL

- Direct feedback for the operator
- Torque and Angle tightening result
- Torque control tightening strategy



No PC needed

100 last results on "CVI Monitor"



Callouts:

- Data to collect
- Password protection
- Battery level
- Ergostop
- Program setting
- Results
- Easy setting

Screen displays: P2, 26.0 Nm, Max angle 185 deg, 10.03Nm, 162.3DEG

B-FLEX ADVANCED (Standard features +)

6 Pset

6 TOOLS in 1 B-FLEX

Angle Strategy

Error proof your standard tightenings

Abort torque	6.500
Max. torque	5.290
Min. torque	4.320
Angle threshold	1.200
Pset start torque	0.480
Min. angle	80.0
Target angle	90.0
Max. angle	100

Full data collection

(up to 10 000 on CVI Analyzer)

CVI ANALYZER

USB cable included

eDOCK

B-FLEX Series - Pistol grip

1.5 to 17 Nm (1.1 to 12.5 ft. lb) - 10 to 1800 rpm



A



B

MODEL	L		A		B		C	
	mm	in.	mm	in.	mm	in.	mm	in.
EPB 8-1800-4Q	227	8.94	32	1.26	206	8.11	38	1.5
EPB 8-1800-10S	227	8.94	32	1.26	206	8.11	38	1.5
EPB 14-900-4Q	227	8.94	32	1.26	206	8.11	38	1.5
EPB 14-900-10S	227	8.94	32	1.26	206	8.11	38	1.5
EPB 17-700-4Q	227	8.94	32	1.26	206	8.11	38	1.5
EPB 17-700-10S	227	8.94	32	1.26	206	8.11	38	1.5

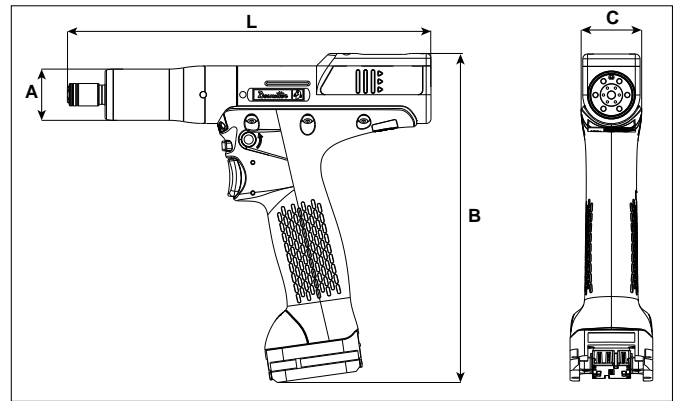

ACCESSORIES
see page 28

PIC REF	MODEL	PART NUMBER	OUTPUT DRIVE	TORQUE RANGE						ROTATIONAL SPEED (RPM)		WEIGHT WITHOUT BATTERY		VOLTAGE
				MIN.	RECOM-MENDED	MAX.	MIN.	RECOM-MENDED	MAX.	18V	36V	kg	lb	
			in.	Nm	Nm	Nm	ft. lb	ft. lb	ft. lb					

B-FLEX - TRANSDUCERIZED BATTERY TOOL

A	EPB 8-1800-4Q	615 165 899 0	Hex.1/4	1.5	7	8	1.1	5.2	5.9	900	1800	1	2.2	18/36
B	EPB 8-1800-10S	615 165 903 0	Sq.3/8	1.5	7	8	1.1	5.2	5.9	900	1800	1	2.2	18/36
A	EPB14-900-4Q	615 165 978 0	Hex.1/4	4	12	14	2.4	8.8	10.3	540	940	1	2.2	18/36
B	EPB14-900-10S	615 165 977 0	Sq.3/8	4	12	14	2.4	8.8	10.3	540	940	1	2.2	18/36
A	EPB 17-700-4Q	615 165 905 0	Hex.1/4	7	15	17	5.2	11	12.5	400	700	1	2.2	18/36
B	EPB 17-700-10S	615 165 901 0	Sq.3/8	7	15	17	5.2	11	12.5	400	700	1	2.2	18/36

B-FLEX - ADVANCED

A	EPBA 8-1800-4Q	615 165 972 0	Hex.1/4	1.5	7	8	1.1	5.2	5.9	900	1800	1	2.2	18/36
B	EPBA 8-1800-10S	615 165 971 0	Sq.3/8	1.5	7	8	1.1	5.2	5.9	900	1800	1	2.2	18/36
A	EPBA14-900-4Q	615 165 974 0	Hex.1/4	4	12	14	2.4	8.8	10.3	540	940	1	2.2	18/36
B	EPBA14-900-10S	615 165 973 0	Sq.3/8	4	12	14	2.4	8.8	10.3	540	940	1	2.2	18/36
A	EPBA 17-700-4Q	615 165 976 0	Hex.1/4	7	15	17	5.2	11	12.5	400	700	1	2.2	18/36
B	EPBA 17-700-10S	615 165 975 0	Sq.3/8	7	15	17	5.2	11	12.5	400	700	1	2.2	18/36

• Battery not included in standard offering

• Battery 18V, 2.5 Ah : 0.46 kg (1.01lb) & 36V, 2.5 Ah : 0.77 kg (1.70lb)

B-FLEX Series - Angle head

5 to 95 Nm (3.7 to 70 ft. lb) - 10 to 900 rpm



A



B



C

MODEL	L		H		H		ØA		ØB	
	mm	in.	mm	in.	mm	in.	mm	in.	mm	in.
EAB 15-900	470	18.5	10.2	0.40	33.8	1.33	22	0.87	37.0	1.46
EAB 26-560	496	19.5	12.0	0.47	45.7	1.80	28	1.10	37.0	1.46
EAB 32-410	496	19.5	12.0	0.47	45.7	1.80	28	1.10	37.0	1.46
EAB 45-330	506	19.9	12.0	0.47	51.0	2.00	35	1.38	37.0	1.46
EAB 50-450	546	21.5	12.0	0.47	51.0	2.00	35	1.38	37.0	1.46
EAB 60-370	559	22.0	11.9	0.468	57.0	2.20	40	1.57	41.0	1.61
EAB 75-300	582	22.9	17.5	0.69	60.4	2.38	45	1.77	48.5	1.91
EAB 95-240	582	22.9	17.5	0.69	60.4	2.38	45	1.77	48.5	1.91

L = Tool length without battery

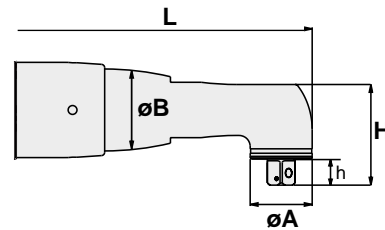

ACCESSOIRES
see page 28

PIC REF	MODEL	PART NUMBER	SQUARE DRIVE	TORQUE RANGE						ROTATIONAL SPEED	WEIGHT WITHOUT BATTERY		VOLTAGE
				MIN.	RECOM-MENDED	MAX.	MIN.	RECOM-MENDED	MAX.		kg	lb	
			in.	Nm	Nm	Nm	ft. lb	ft. lb	ft. lb	rpm			V
B-FLEX - TRANSDUCERIZED BATTERY TOOL													
•	EAB 15-900	615 165 731 0	1/4	5	13	15	3.7	9.6	11	900	1.55	3.42	36
A	EAB 26-560	615 165 732 0	3/8	5	24	26	3.7	18	19	560	1.65	3.64	36
A	EAB 32-410	615 165 733 0	3/8	7	30	32	5.2	22	24	410	1.65	3.64	36
B	EAB 45-330	615 165 734 0	3/8	9	40	45	6.6	30	33	330	1.76	3.88	36
B	EAB 50-450	615 165 735 0	3/8	9	45	50	6.6	33	37	450	2.04	4.50	36
B	EAB 60-370	615 165 736 0	1/2	10	55	60	7.4	41	44	370	2.35	5.18	36
C	EAB 75-300	615 165 737 0	1/2	12	70	75	8.8	52	55	300	2.94	6.48	36
C	EAB 95-240	615 165 738 0	1/2	19	90	95	14	66	70	240	2.98	6.57	36

B-FLEX - ADVANCED

•	EABA15-900	615 165 961 0	1/4	5	13	15	3.7	9.6	11	900	1.55	3.42	36
A	EABA26-560	615 165 962 0	3/8	5	24	26	3.7	18	19	560	1.65	3.64	36
A	EABA32-410	615 165 963 0	3/8	7	30	32	5.2	22	24	410	1.65	3.64	36
B	EABA45-330	615 165 964 0	3/8	9	40	45	6.6	30	33	330	1.76	3.88	36
B	EABA50-450	615 165 965 0	3/8	9	45	50	6.6	33	37	450	2.04	4.50	36
B	EABA60-370	615 165 966 0	1/2	10	55	60	7.4	41	44	370	2.35	5.18	36
C	EABA75-300	615 165 967 0	1/2	12	70	75	8.8	52	55	300	2.94	6.48	36
C	EABA95-240	615 165 968 0	1/2	19	90	95	14	66	70	240	2.98	6.57	36

- Battery not included in standard offering
- Battery 36V, 2.5Ah - Weight: 0.77 kg (1.70lb)

B-FLEX QRX

5 to 95 Nm (3.7 to 70 ft. lb) - 10 to 560 rpm

Advanced Multi Applications Tool



BOOST YOUR PRODUCTIVITY

Real Time Pset selection for the selected Quick release accessory with RFID technology

BOOST YOUR FLEXIBILITY

Possibility to use the same tool for multiple applications

MODEL	PART NUMBER	TORQUE			ROTATIONAL MAX SPEED (RPM)	WEIGHT*	
		MIN	NOMINAL	MAX		kg	ilb
		Nm	Nm	Nm			
EABA26-560 QRX	615 166 080 0	5	24	26	560	2.04	4.50
EABA32-410 QRX	615 166 081 0	7	30	32	410	2.04	4.50
EABA45-330 QRX	615 166 082 0	9	40	45	330	2.21	4.87
EABA50-450 QRX	615 166 083 0	9	45	50	450	2.49	5.49
EABA60-370 QRX	615 166 084 0	10	55	60	370	2.82	6.22
EABA75-300 QRX	615 166 085 0	12	70	75	300	3.42	7.54
EABA95-240 QRX	615 166 086 0	19	90	95	240	3.46	7.63

*Weight without battery

All tools are powered by a battery pack 36V 2.5Ah

Battery 36V, 2.5Ah - Weight : 0.77 kg (1.70lb)

BLRTA

10 to 25 Nm (7.4 to 18.4 ft.lb) - 1520 to 2350 rpm



A



B

BOOST YOUR PRODUCTIVITY

- By reducing cycle time
- By improving joint quality
- By providing process quality

BOOST YOUR FLEXIBILITY

- Free of cable management
- Free of reaction arm
- Reduce total cost of ownership

BOOST YOUR UP TIME

- Boost the uptime of the operator
- Boost the uptime of the tool

	STANDALONE VERSION
Wifi Communication	N/A
Programming on the tool	✓
Pset	6
No. of step in Pset	1
Assembly process	N/A
Results	10 000 with CVI analyzer
Tightening Curve	N/A
Disconnected mode	N/A



ACCESSORIES
see page 28

PIC REF	MODEL	PART NUMBER	OUTPUT DRIVE	OUTPUT RETAINING TYPE	TORQUE				ROTATIONAL MAX SPEED (RPM)		LENGTH		WEIGHT*		VOL-TAGE
					MIN	MAX	MIN	MAX	18V	36V	mm	in.	kg	in.	
					Nm	Nm	ft.lb	ft.lb							
A	BLRTA025-2350-10S	615 166 023 0	Sq 3/8	Through hole	6	25	4.4	18.4	1520	2350	233	9.17	1.2	2.6	18/36
B	BLRTA025-2350-4Q	615 166 024 0	Hex. 1/4	Quick change chuck	6	25	4.4	18.4	1520	2350	233	9.17	1.2	2.6	18/36
-	BLRTA045-3990-10S	615 166 187 0	Sq 3/8	Through hole	15	45	11.6	33.19	-	3990	251	9.9	1.34	2.96	36

*Weight without battery

Accessories



B-FLEX / QRX / BLRTA / EAB / EPB

ACCESSORIES INCLUDED

	EPB/EPBA	BLRTA
• Pistol protective cover Red	615 211 022 0	615 211 073 0

OPTIONAL ACCESSORIES

ITEM	EAB/QRX	EPB/EPBA	BLRTA
------	---------	----------	-------

Battery type

1	Li-ion battery pack 18V 2.5 Ah - 0.46 kg (1,01lb)	615 813 266 0	615 813 266 0
2	Li-ion battery pack 36V 2.5 Ah - 0,77 kg (1,70lb)	615 813 267 0	615 813 267 0

Charger

3	Charger Universal 18 / 36V	615 813 270 0	615 813 270 0	615 813 270 0
•	Power Cord C13-C14 L=0.3m (daisy chain cable)	615 813 383 0	615 813 383 0	615 813 383 0

Protective covers - Tools

4	For Angle head EAB 15	615 211 003 0		
4	For Angle head EAB 26/32	615 573 207 0		
4	For Angle head EAB 45/50	615 573 208 0		
4	For Angle head EAB 60	615 573 209 0		
4	For Angle head EAB 75/95	615 573 210 0		
5	Pistol protective cover Black	615 211 019 0		

Protective covers - Battery

6	For Battery 18V 2.5Ah - Clear	615 211 136 0	615 211 136 0	
6	For Battery 18V 2.5Ah - Black	615 211 137 0	615 211 137 0	
6	For Battery 18V 2.5Ah - Red	615 211 138 0	615 211 138 0	
6	For Battery 18V 2.5Ah - Grey	615 211 139 0	615 211 139 0	
6	For Battery 36V 2.5Ah - Clear	615 211 140 0	615 211 140 0	615 211 140 0
6	For Battery 36V 2.5Ah - Black	615 211 141 0	615 211 141 0	615 211 141 0
6	For Battery 36V 2.5Ah - Red	615 211 142 0	615 211 142 0	615 211 142 0
6	For Battery 36V 2.5Ah - Grey	615 211 143 0	615 211 143 0	615 211 143 0

Miscellaneous

7	Nose crowfoot adapter for EPB	615 565 518 0		
8	eDOCK + Battery data interface	615 813 400 0	615 813 400 0	615 813 400 0
9	Side handle	615 397 016 0		

Desoutter Tool holster

10	DTH TWIN (single) without rail	615 811 411 0		
11	DTH TWIN rail kit with 2 Twin holders	615 811 412 5		
12	DTH TWIN stand kit with 2 Twin holders	615 811 413 5		
13	DTH90	615 812 119 0	615 812 119 0	

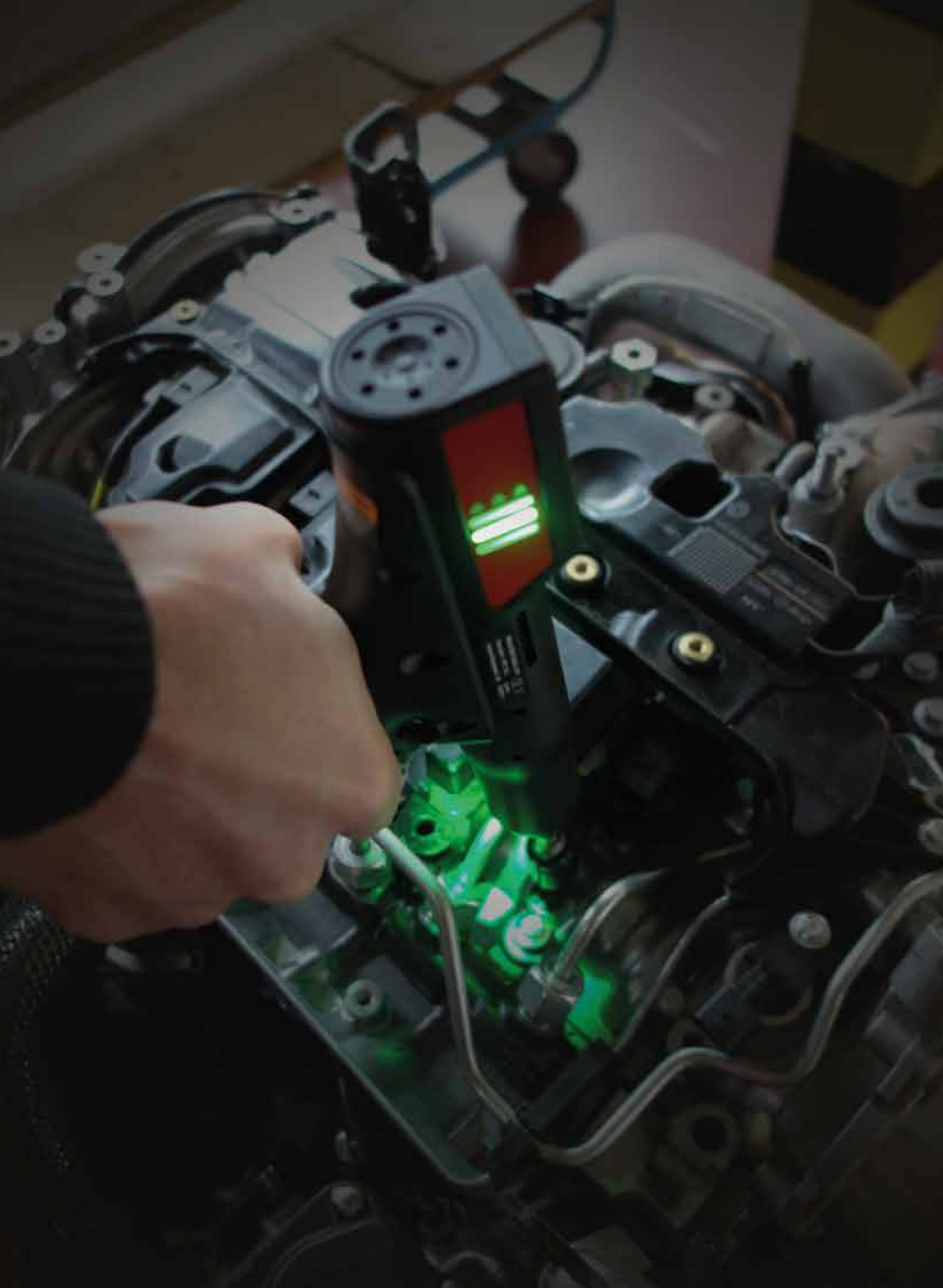

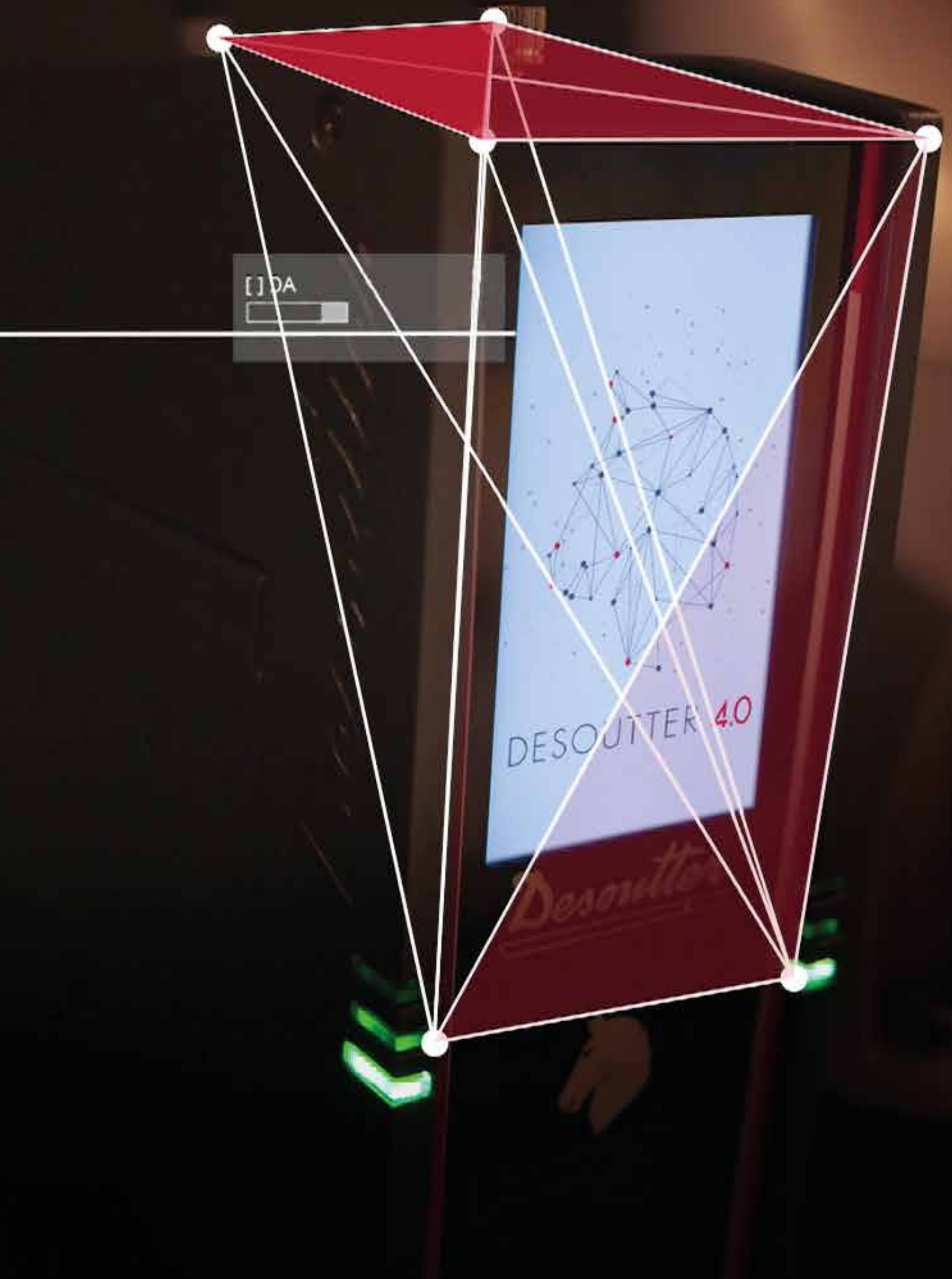

[] DA
[Progress bar]



DESOUTTER 4.0

Desoutter



CONNECT - Industrial Smart Hub



SINGLE POINT OF CONNECTION FOR UP TO 20 TOOLS

With only one safety power supply
With only one Ethernet/fieldbus connection
With only one stand to mount the CONNECT

CAPACITIVE INDUSTRIAL GRADE TOUCH SCREEN

With several display options and quick response time.

MULTI-TOOL SOLUTION

Up to 20 tools connected to only one CONNECT.

FINE-TUNES SETTINGS & SCALABLE SOLUTION

With feature management fine-tunes the Tightening Units by loading only features needed for each application.



FOOTPRINT OPTIMIZATION

With a volume of only 4L, the CONNECT can be installed anywhere, under any constraints.

FEATURE REBALANCING

Easy feature rebalancing from tightening unit to another one.

EASY LINE REBALANCING

Pair the tool in less than 10 seconds, with easy contactless pairing feature.

REMOVABLE INTEGRATED MEMORY

Transfer DATA and settings from one CONNECT to another in a fast and effective way.



CONNECT - Industrial Smart Hub

CONNECT has been designed to meet today's and tomorrow's demanding production processes.



Each Tightening Unit activated includes a Standard package. The standard package has been built to meet with more than 80% of requirements.

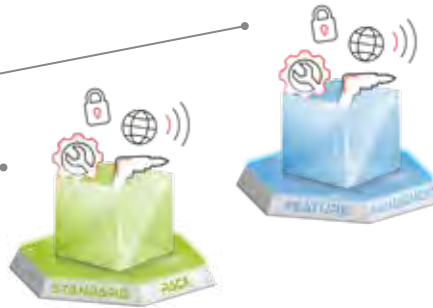

For more demanding applications, it is possible to activate additional features.

MULTI-CORDLESS TOOL SOLUTION

SCALABLE SOLUTION

EASY TOOL & FEATURE REBALANCING

FULL TRACEABILITY

INDUSTRIAL SMART HUB

CONNECT is a powerful platform able to manage all items related to the assembly line

With error proofing accessories and full traceability management for up to 20 tools, CONNECT is a solution with a **HIGH LEVEL OF CONNECTIVITY** to manage and control the assembly line under all circumstances.

FEATURE MANAGEMENT

FEATURE MANGEMENT is a scalable solution which allows you to get what you really need

With its **HIGH LEVEL OF FLEXIBILITY**, you can add new features whenever the requirements on your production line change. You just have to activate the feature and it is ready to use.

TOOL RANGE COMPATIBLE

COMPATIBLE WITH ALL DESOUTTER CORDLESS TOOLS with IEEE 802.11 wireless communication.



◦ EABC



◦ EPBC



◦ BLRTC



◦ QSHIELD



◦ EABS



◦ E-LIT



CONNECT - Industrial Smart Hub

Multi-Cordless Tool solution

CONNECT-W

With embedded access point **Up to 10 tightening units activated.**

With **CONNECT-W**, 10 tightening units can be activated which means 10 cordless tools can be paired.

CONNECT-X

Requires an external access point **Up to 20 tightening units activated** (No embedded access point).

With **CONNECT-X**, 20 tightening units can be activated which means 20 cordless tools can be paired.



Tool's Rebalancing



EASY CONTACTLESS PAIRING

With easy wireless pairing, tool is paired in less than **10 seconds.**

Desoutter Sight



VISUALIZATION

- Remote access to CONNECT menu for on-line adjustment
- Display in real-time the results per TU / workstation

Virtual Cable



TRACKING SOLUTION

- Ensures the use of tools in the right locations and applications
- Easy to install and set up with the Easy Teaching mode

CONNECT - Industrial Smart Hub

Get what you really need with feature management

FEATURE MANAGEMENT is a scalable solution in order to provide a high level of flexibility to meet requirements. With feature management, you can add or remove a feature whenever you want or whatever the feature.

HOW DOES IT WORK ?

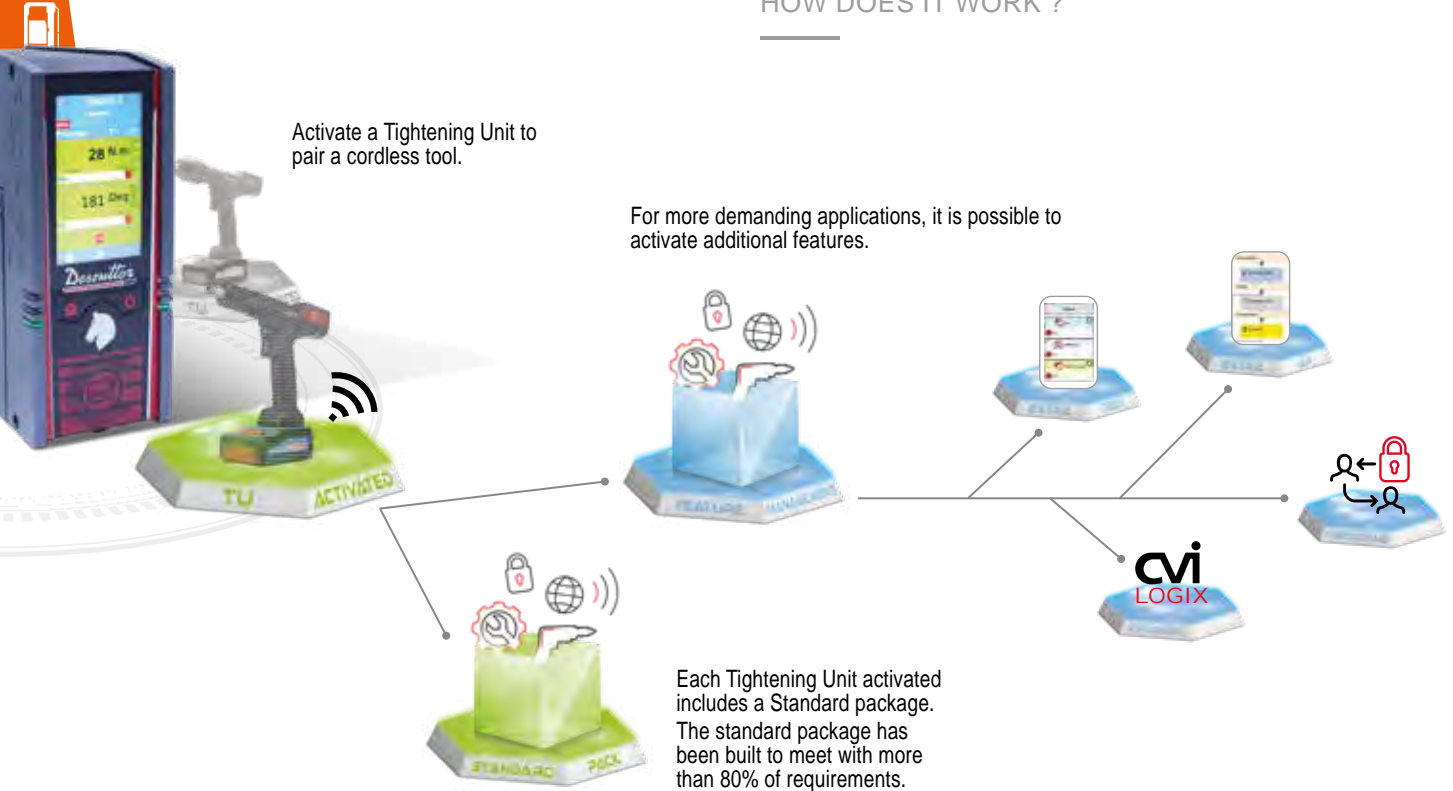

SEVERAL TIGHTENING UNITS [TU] ARE AVAILABLE ON CONNECT PLATFORM WITH DIFFERENT STANDARD PACK FEATURE LEVELS

STANDARD PACK

	TU PREMIUM	TU ESSENTIAL	TU E-LIT WIFI	TU DIGITAL WRENCH
Compatible tool	EABC, EPBC, EABS, BLRTC	EABC, EPBC, EABS, BLRTC	ELC-P-W, ELC-A-W	QShield-C
Number of Pset	10	6	4	10
Number of Assembly Process	10	6	4	10
Live Results	Torque & angle values curves	Torque & angle values curves	OK/NOK	Torque & Angle values curves
Result Transfer/storage	Torque & angle values + curves	OK/NOK	OK/NOK	Torque & Angle values curves
Tightening strategy	Torque and/or angle control Torque and/or angle monitoring	Torque control angle monitoring	Torque control	Torque or Angle control Torque or Angle monitoring
Protocol	Open protocol	Open protocol	Open protocol	Open protocol
Pairing	RFID or eDock pairing	RFID or eDock pairing	eDock pairing	RFID or USB pairing

CONNECT - Industrial Smart Hub

FEATURES UNDER FEATURE MANAGEMENT ?

Feature activation is done Tightening Unit per Tightening Unit for more flexibility on your production line.

Feature management is required:

- For each Tightening Unit activation:



TIGHTENING UNIT
Up to 10 TU with CONNECT-W
Up to 20 TU with CONNECT-X
TU PREMIUM / TU ESSENTIAL / TU E-LIT WIFI
/ TU DIGITAL WRENCH

- For zone control activation



VIRTUAL CABLE
Tracker with one or multiple workings spaces
TU PREMIUM / TU ESSENTIAL

- For additional Pset activation



EXTRA PSET
Pack "up to 50 PSET"
Pack "up to 250 PSET"
TU PREMIUM / TU DIGITAL WRENCH

- For specific Protocol activation



PROTOCOL
Desoutter protocol
Customer protocols
TU PREMIUM / TU ESSENTIAL / TU E-LIT WIFI
/ TU DIGITAL WRENCH

- For additional Assembly Process activation

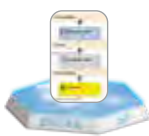

EXTRA ASSEMBLY PROCESS
Pack "up to 50 AP"
Pack "up to 250 AP"
TU PREMIUM / TU DIGITAL WRENCH

- For CVI logix activation



**AUTOMATION CONTROL
CVI LOGIX**
TU PREMIUM / TU ESSENTIAL / TU E-LIT WIFI

- For specific strategies activation

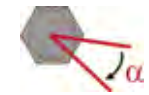

STRATEGIES
Residual Torque
TU DIGITAL WRENCH

HOW TO ACTIVATE A FEATURE ?

○ THE HIGH FLEXIBILITY OF FEATURE MANAGEMENT IS REACHED THANKS TO UV*.

○ ANY OR ALL FEATURES CAN BE ACTIVATED BY APPLYING UV*.

○ EACH FEATURE HAS ITS OWN UV*.

* UV = Unit Value



	CONNECT-W	CONNECT-X
Weight	2,8 kg	
Volume	4,2 Liters	
Display	Capacitive color touch screen (4,3")	
Access point	EMBEDDED (includes internal access point)	NOT INCLUDED (external access point required)
Removable Integrated Memory	Included (accessible from front panel)	
Power supply	110V – 220V or 24V	
Connectivity	4 Ethernet ports – 4 USB ports – RS-232 port – eBUS port – fieldbus card slot	
IP Protection	IP 40 IP54 with an additional accessory	
Accessories	Wall mounting – stack light - socket tray – bit tray – operator panel – field bus - I/O expander - Desoutter Sight	

CONNECT - Industrial Smart Hub



PIC REF	MODEL	PART NUMBER	CONSUMPTION (CURRENT)		MAIN SUPPLY	DIMENSIONS						WEIGHT	
			115V	230V		WIDTH		HEIGHT		DEPTH		kg	lb.
A	CONNECT-X	615 932 722 0	< 1A	< 1A	Single-phase	90	3.5	221	8.70	210	2.8	2.8	6.17
B	CONNECT-W	615 932 723 0	< 1A	< 1A	Single-phase	90	3.5	221	8.70	210	2.8	2.8	6.17



- 1 Switch On/Off
- 2 Auto-Sensing Voltage 110-240V
- 3 24V power supply
- 4 RS232 port
- 5 eBUS port (Bus dedicated to Error Proofing Integration accessories - EPI)
- 6 Ethernet switch with 4 Ethernet ports (including one POE)
- 7 2 USB ports on connector panel + 2 USB ports on front panel
- 8 Plug & Play Fieldbus module port

FEATURE MANAGEMENT

PIC REF	DESCRIPTION	PART NUMBER
A	UV	615 927 843 0
B	eWallet	615 927 844 0



POWER CORD to be ordered with CONNECT

PLUG	DESCRIPTION	PART NO.
A	European	615 917 739 0
B	US	615 917 741 0
C	UK	615 917 740 0
D	Chinese	615 917 742 0

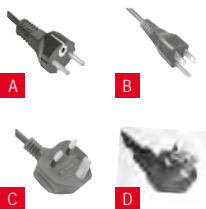

OPTIONAL ACCESSORIES

ITEM	PART NO.
Fieldbus modules	
1 Profibus module	615 927 595 0
2 ProfiNet module (1 port)	615 927 596 0
3 ProfiNet module (2 ports)	615 927 597 0
3 ProfiNet IRT module (2 ports)	615 927 070 0
4 DeviceNet module	615 927 599 0
4 CC-Link module	615 927 598 0
5 EtherNet IP module	615 927 594 0
6 Modbus TCP module	615 927 615 0
Others	
• Advanced wall mounting	615 399 631 0





QShield - Connected

Digital Wrench for Torque & Angle full track and trace



RFID TAG End-fittings with automatic recognition for ratio management and/or Pset selection



New Gyroscope
(Angle 1,2° to 250°/s)

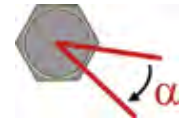

Length independent transducer with double bridge strain gauge to guarantee a tightening result regardless of the position of the operator's hand.

Accuracy of +/-1% on Torque reading value (from 10 to 100% of the nominal torque)

Standard interchangeable heads and reversible ratchets



Industrial IoT gateway module

- Dual band (2.4 & 5 Ghz)
- Wi-Fi enterprise security
- Global certification (TLS encryption)

New Wrench Protection



New easy pairing & rebalancing



Mini USB port for firmware upgrades & Calibrations



RGB Color display
Visual feedback AND a complementary configurable vibration for operator guidance

New Li-Ion Battery
8 hours



- ISO 6789:2017 compliance
- Wireless Communication & Easy Pairing
- Real Time reporting & traceability
- Feature Management & rebalancing
- A Unique platform of Multi-Tools on CONNECT allowing Tightening / Rework stations

Digital Wrench on CONNECT

QSHIELD-C is a unique flexible solution to secure safety and quality critical applications on production lines, either requiring the highest precision on both torque and angle, tightening sequences with interchangeable heads, or simply enable assembly in difficult access conditions. It's a step in the evolution of processes to ramp up until production volumes justify investments to semi-automatic or fully automated processes. Ultimately, it's also accurate and flexible enough to allow a rework from previous stations.



ACCESSORIES
see page 180-181

MODEL	PART NUMBER	RANGE		ANGLE	DRIVE		INCLUDED RATCHET	LENGHT WITHOUT RATCHET		LEVER ARM*		WEIGHT	
		Nm	ft.lbs		mm	in.		mm	in.	mm	in.	kg	lb.
Q-SHIELD 30-C	615 935 200 0	3 - 30	2.21 - 22.13	✓	9x12	0.35x0.47	3/8	402	15.83	320	12.6	0.7	1.5
Q-SHIELD 150-C	615 935 201 0	15 - 150	11.06 - 110.6	✓	14x18	0.55x0.71	1/2	418	16.46	342	13.5	0.8	1.7
Q-SHIELD 200-C	615 935 202 0	20 - 200	14.75 - 147.5	✓	14x18	0.55x0.71	1/2	627	24.7	552	21.75	1.6	3.5
Q-SHIELD 350-C	615 221 037 0	35 - 350	25.81 - 258.1	✓	14x18	0.55x0.71	3/4	694	27.33	625.5	24.62	2.6	5.7
Q-SHIELD 400-C	615 935 203 0	40 - 400	29.5 - 295.0	✓	14x18	0.55x0.71	3/4	1028	40.48	960	37.8	3.2	7.0
Q-SHIELD 500-C	615 935 204 0	50 - 500	36.88 - 368.8	✓	21x26	0.82x1.02	3/4	1137	44.77	1100	43.3	5.5	12.1
Q-SHIELD 800-C	615 935 205 0	80 - 800	59.0 - 590.0	✓	dia 28	dia 1.1	1	1314	51.74	1362	53.62	6.7	14.7
Q-SHIELD 900-C	615 935 206 0	90 - 900	66.38 - 663.8	✓	dia 28	dia 1.1	1	1392	54.8	1440	56.7	8.2	18.0

* Useful length is from Ratchet axis to handle middle

All models are supplied with box including reversible ratchet with TAG (QShield Batteries supplied seperately)



PIC REF	MODEL	PART NUMBER	HEIGHT		LENGTH		WIDTH		WEIGHT	
			mm	in	mm	in	mm	in	gr	lb
A	QShield Battery	615 936 500 0	-	-	110	4.33	Ø 22	Ø 8.86	80	0.18
B	Battery Charger	615 936 151 0	60	2.36	140	5.51	80	3.15	240	0.53
C	Wrench Protection	615 936 504 0	-	-	-	-	-	-	-	-

Fieldbus / Process

Data network / Traceability



QShield-C Strategies



TORQUE STRATEGY :
Tightening to a Target Torque with a monitoring of the Angle and Torque
(OK if both Torque and Angle are within Min/Max)

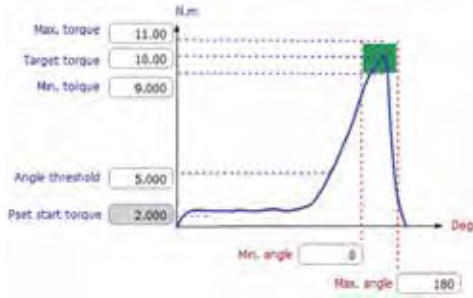

ANGLE STRATEGY :
Tightening to a Target Angle with a monitoring of the Torque and Angle
(OK if both Torque and Angle are within Min/Max)

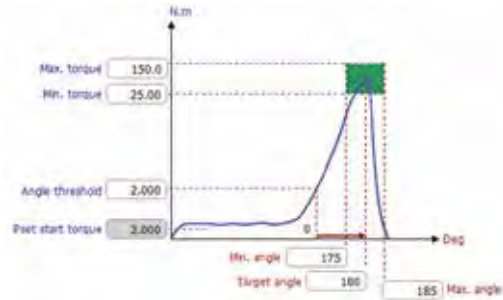

RESIDUAL TORQUE STRATEGY :
Joint check in Production on pre-tightened joints
(NOK management)

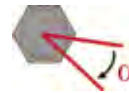
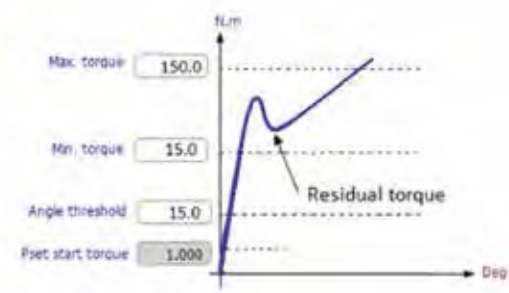

Triple result detection
Residual + Breakaway (B)
+ Peak Torque (P)



7 TYPICAL SCENARIOS

- 1 Start of production (low quantities - ROI)
- 2 Difficult access conditions
- 3 More accuracy
- 4 Sequence using different end-fittings
- 5 Tighten to angle
- 6 Rework station (Diversity & Uptime)
- 7 PCT Test (Residual torque / Joint check)

+
BENEFITS

- Accuracy for critical tightenings
- Wide torque range to replace click wrenches
- Production data traceability
- Repair station fastening capability
- Difficult access joints tightening
- Re-hit detection
- Low calibration cost
- Back up tool for safety & quality critical applications



Virtual Cable

Virtual Cable is an Ultra Wide Band solution (UWB) used within the CONNECT hub platform that enables total traceability and control over tools locations and applications.

Virtual Cable ensures that the correct wireless tool can only be used for its pre-determined tasks in the correct working area. The tool is enabled for tightening only in the defined working area preventing Production errors and Quality issues.

Manage up to 20 tools in the right areas!

BOOST YOUR PRODUCTIVITY

- You can standardise battery tools locating tools in the right working areas
- Ergonomic solution suitable for confined applications and inside cars

BOOST YOUR UP TIME

- Create your working area in less than 10s with the unique Trigger Learning mode by directly pressing the tool's trigger
- Power supply via PoE

BOOST YOUR FLEXIBILITY

- Easy to rebalance tools
- Manage up to 20 tools in different areas

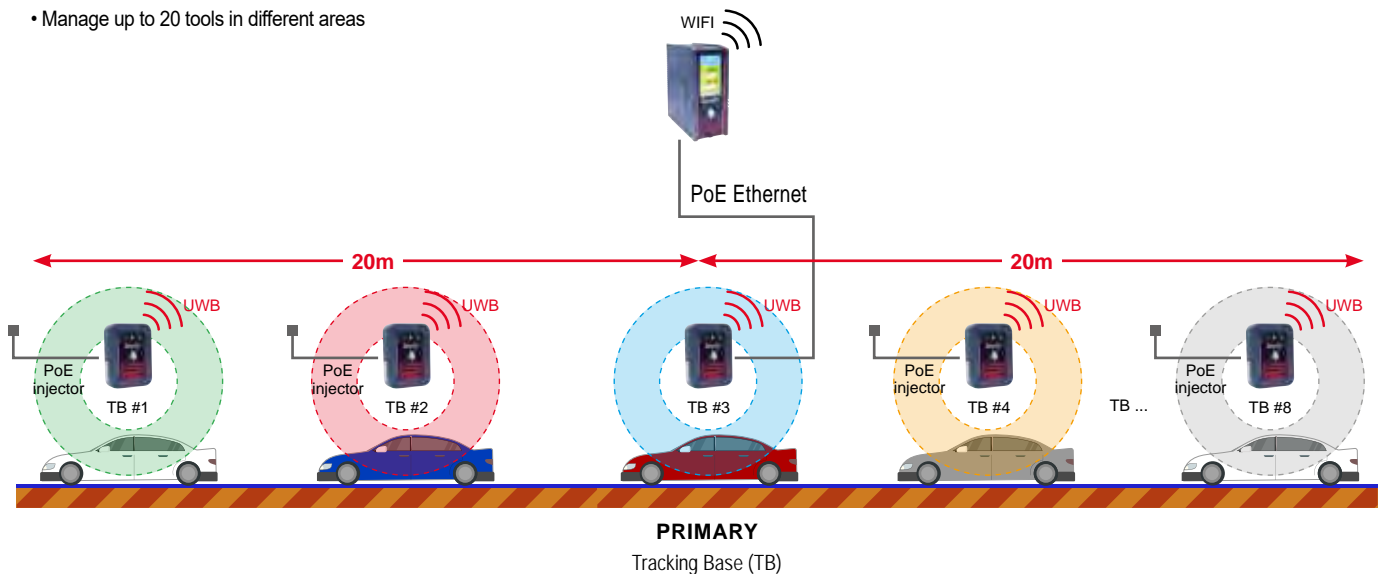

SPECIFICATIONS

ORDERING INFORMATION	PART NUMBER
Tracking Base	615 813 335 0
Tracker for EPBC tools	615 813 260 0
Tracker for EABC tools	615 813 259 0
Tracker for EABS tools	615 813 415 0
PoE Injector	615 813 263 0
PERFORMANCE	
Frequency Range	3.5 to 6.5 GHz
Area coverage	Sphere of 20m (65.6 ft) of radius
Max. number of Tracking bases per CONNECT	8
Max. number of areas per Tracking Base	8
Max. number of tools per CONNECT	20

TECHNICAL SPECIFICATIONS	
Environmental Sealing	Tracker: IP40 Tracking base: IP54
Power consumption	Tracking base PoE: 20mA
Power supply	802.11af PoE Injector, 100-240 VAC
Tracking Base dimensions	110 x 150 x 40 mm (4.33 x 95.9 x 1.75 in.)

SIGHT

SIGHT is the Desoutter HMI solution within the CONNECT hub Platform. A flexible display range with sizes 7", 15" and a module to be adapted to any size display available at the factory site.

It enables visualisation of tightening results and Assembly Process follow-up.

In addition to this you can have remote access to the CONNECT menu for on-line adjustment. Production is safe controlling operators' rights with the CVI Key.



BOOST YOUR PRODUCTIVITY

- Display Assembly Processes & Tightening Results in a configurable screen

BOOST YOUR UP TIME

- Remote access to CONNECT configuration: Move the CONNECT away from the production line and reduce your time and costs of installation
- Easy installation with Ethernet or WiFi communication. PoE powered

BOOST YOUR FLEXIBILITY

- You can use your own HMI with the SIGHT Module: no need to homologate additional hardware



MODEL	PART NUMBER	SIZE	DIMENSIONS						WEIGHT	
			WIDTH		HEIGHT		DEPTH		kg	lb.
			mm	in.	mm	in.	mm	in.		
SIGHT 7"	615 813 253 0	7"	198	7.8	137	5.4	48	1.9	0.9	2.0
SIGHT 15"	615 813 254 0	15"	407	16.0	257	10.1	63	2.5	4	8.8
SIGHT MODULE	615 813 255 0	Customer display	-	-	-	-	-	-	-	-

OPTIONAL ACCESSORIES

	PART NO.
Power adaptor 12V for SIGHT power supply	615 813 262 0
Power supply cable: dedicated for power adaptor 12V and power injector PoE	
- European	615 917 201 0
- US	615 917 203 0
- UK	615 917 202 0
- Chinese	615 917 206 0
PoE+ 30W Power injector	615 813 263 0
VESA support for SIGHT 15" (100x100)	615 813 258 0
VESA support for SIGHT 7" (35x75)	615 813 288 0
Antenna kit for SIGHT 15" and SIGHT Module	615 813 386 0
Antenna kit for SIGHT 7"	615 813 387 0

EABS - The One Hand Nutrunner



EABS - The One Hand Nutrunner

COMPACTNESS

EABS IS A CONCENTRATION OF ADVANCED TECHNOLOGY which allows to get a compactness never reached up to now with transducerized battery tools.

With a length at 30 cm, EABS can be used with only one hand. Consequently, one hand is released and could be used either to boost productivity or to improve operator's balance during tightening.

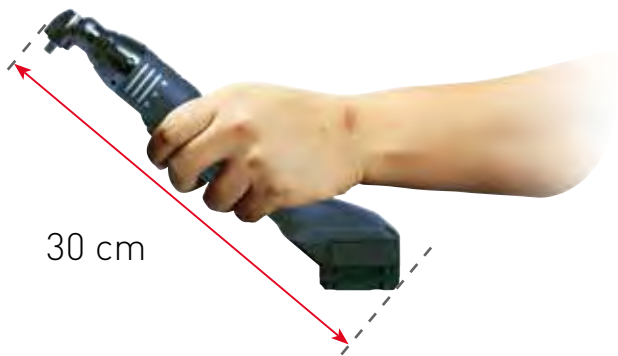

HIGH SPEED BATTERY TOOLS WITH 18V BATTERY



EABS IS A PERFECT BALANCE BETWEEN ERGONOMICS AND PRODUCTIVITY

EABS can reach really high speed to boost your productivity even with an 18V battery. Indeed, with an EABS 8 model and an EABS 12 model, free speed values are higher than 1000 rpm while preserving ergonomy with a total weight less than 1.5 kg.

TOOL'S REBALANCING



EASY WIRELESS PAIRING

The EABS tool has an embedded RFID chip for fast and efficient pairing with the CONNECT. Error proofing the process and eliminating any potential wireless setting mistakes.

With easy wireless pairing, tool is paired in less than 10 seconds.

EABS Series

1.5 to 24 Nm (1.1 to 16.2 ft.lb) – 10 to 1500 rpm



MODEL	L		ØA		ØB		ØC	
	mm	in.	mm	in.	mm	in.	mm	in.
EABS8-1500	297	11.69	39	1.54	22	0.87	22	0.87
EABS12-1100	297	11.69	39	1.54	22	0.87	22	0.87
EABS17-800	297	11.69	39	1.54	22	0.87	22	0.87
EABS24-500	335	13.19	39	1.54	23	0.91	28	1.10

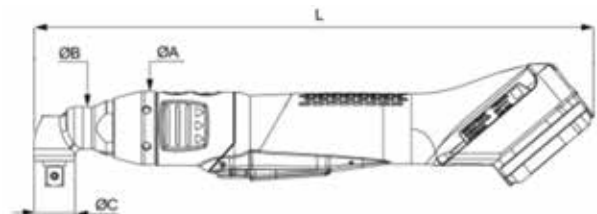

ACCESSORIES
see page 50

PIC REF	MODEL	PART NUMBER	OUTPUT DRIVE	TORQUE						MAX. ROTATIONAL SPEED	WEIGHT*		LENGTH*		VOLTAGE
				MIN.	RECOMMENDED	MAX	MIN.	RECOMMENDED	MAX.		Kg	lb	mm	.in	
			in.	Nm	Nm	Nm	ft.lb	ft.lb	ft.lb	rpm					
A	EABS8-1500-4Q	615 166 088 0	Hex.1/4	1.5	7	8	1.10	5.16	5.90	1500	1.0	2.20	297	11.69	18/36
B	EABS8-1500-4S	615 166 087 0	Sq 1/4	1.5	7	8	1.10	5.16	5.90	1500	1.0	2.20	297	11.69	18/36
A	EABS12-1100-4Q	615 166 091 0	Hex.1/4	4	10	12	2.95	7.37	8.85	1100	1.0	2.20	297	11.69	18/36
B	EABS12-1100-4S	615 166 089 0	Sq 1/4	4	10	12	2.95	7.37	8.85	1100	1.0	2.20	297	11.69	18/36
B	EABS12-1100-10S	615 166 090 0	Sq 3/8	4	10	12	2.95	7.37	8.85	1100	1.0	2.20	297	11.69	18/36
A	EABS17-800-4Q	615 166 094 0	Hex.1/4	5	14	17	3.68	10.32	12.53	800	1.0	2.20	297	11.69	18/36
B	EABS17-800-4S	615 166 092 0	Sq 1/4	5	14	17	3.68	10.32	12.53	800	1.0	2.20	297	11.69	18/36
B	EABS17-800-10S	615 166 093 0	Sq 3/8	5	14	17	3.68	10.32	12.53	800	1.0	2.20	297	11.69	18/36
C	EABS24-500-4Q	615 166 096 0	Hex.1/4	10	22	24	7.37	16.22	17.70	520	1.3	2.87	335	13.19	18/36
D	EABS24-500-10S	615 166 095 0	Sq 3/8	10	22	24	7.37	16.22	17.70	520	1.3	2.87	335	13.19	18/36

*Weight and length without battery

BLRTC

10 to 25 Nm (7.4 to 18.4 ft.lb) - 1520 to 2350 rpm



A



B

BOOST YOUR PRODUCTIVITY

- By reducing cycle time
- By improving joint quality
- By providing process quality

BOOST YOUR FLEXIBILITY

- Free of cable management
- Free of reaction arm
- Reduce total cost of ownership

BOOST YOUR UP TIME

- Boost the uptime of the operator
- Boost the uptime of the tool

	WIFI COMMUNICATION VERSION
Wifi Communication	2.4GHz or 5 GHz
Programming on the tool	N/A
Pset	250
No. of step in Pset	10
Assembly process	250
Results	10000
Tightening Curve	20
Disconnected mode	✓



ACCESSORIES
see page 50

PIC REF	MODEL	PART NUMBER	OUTPUT DRIVE	OUTPUT RETAINING TYPE	TORQUE				ROTATIONAL MAX SPEED (RPM)		LENGTH		WEIGHT*		VOL-TAGE
					MIN	MAX	MIN	MAX	18V	36V	mm	in.	kg	in.	
					Nm	Nm	ft.lb	ft.lb							
A	BLRTC025-2350-10S	615 166 025 0	Sq 3/8	Through hole	6	25	4.4	18.4	1520	2350	233	9.17	1.2	2.6	18/36
B	BLRTC025-2350-4Q	615 166 026 0	Hex. 1/4	Quick change chuck	6	25	4.4	18.4	1520	2350	233	9.17	1.2	2.6	18/36
-	BLRTC045-3990-10S	615 166 186 0	Sq 3/8	Through hole	15	45	11.6	33.19	-	3990	251	9.9	1.34	2.96	36

*Weight without battery

Wireless transducerized battery tool



ADVANCED ERGONOMICS

- Low weight tools
- Effortless trigger
- 45° oriented battery (angle version)
- Slim angle head for tight areas access

EASY INTEGRATION

- Quick wireless installation with contactless RFID pairing
- Data collection through wireless communication
- Improve error-proofing control with advanced tightening strategies
- Easy attachment for crowfoot & tubenuts

INCREASED PRODUCTIVITY

- High speed tool
- Embedded display for pset selection
- Strong & efficient wireless communication, tested in industrial environment

OPTIMIZED MAINTENANCE

- Long life batteries, no memory effect on Li-ion battery
- Dust & oil proof trigger
- Common spare parts

EPBcom Series

1.5 to 17 Nm (1.1 to 12.5 ft.lb) - 10 to 1800 rpm



A



B

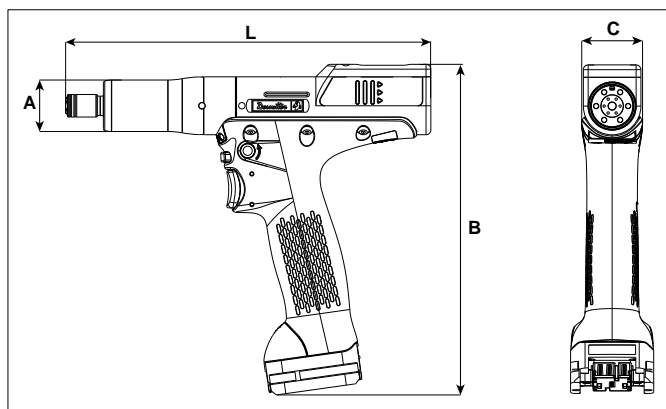

MODEL	L		A		B		C	
	mm	in.	mm	in.	mm	in.	mm	in.
EPBC 8-1800-4Q	227	8.94	32	1.26	206	8.11	38	1.5
EPBC 8-1800-10S	227	8.94	32	1.26	206	8.11	38	1.5
EPBC14-900-4Q	227	8.94	32	1.26	206	8.11	38	1.5
EPBC14-900-10S	227	8.94	32	1.26	206	8.11	38	1.5
EPBC 17-700-4Q	227	8.94	32	1.26	206	8.11	38	1.5
EPBC 17-700-10S	227	8.94	32	1.26	206	8.11	38	1.5



ACCESSORIES
see page 50

PIC REF	MODEL	PART NUMBER	OUTPUT DRIVE	TORQUE RANGE						ROTATIONAL SPEED (RPM)		WEIGHT WITHOUT BATTERY		VOLTAGE
				MIN.	RECOM-MENDED	MAX.	MIN.	RECOM-MENDED	MAX.	18V	36V	kg	lb	
			in.	Nm	Nm	Nm	ft.lb	ft.lb	ft.lb					

EPBcom - TRANSDUCERIZED BATTERY TOOL

A	EPBC 8-1800-4Q	615 165 900 0	Hex.1/4"F	1.5	7	8	1.1	5.2	5.9	900	1800	1.0	2.2	18/36
B	EPBC 8-1800-10S	615 165 904 0	Sq.3/8	1.5	7	8	1.1	5.2	5.9	900	1800	1.0	2.2	18/36
A	EPBC14-900-4Q	615 165 980 0	Hex.1/4"F	4	12	14	2.9	8.8	10.3	540	940	1.0	2.2	18/36
B	EPBC14-900-10S	615 165 979 0	Sq. 3/8	4	12	14	2.9	8.8	10.3	540	940	1.0	2.2	18/36
A	EPBC 17-700-4Q	615 165 906 0	Hex.1/4"F	7	15	17	5.2	11	12.5	400	700	1.0	2.2	18/36
B	EPBC 17-700-10S	615 165 902 0	Sq.3/8	7	15	17	5.2	11	12.5	400	700	1.0	2.2	18/36

- Battery not included in standard offering
- Battery 18V, 2.5 Ah : 0.46 kg (1.01lb) & 36V, 2.5 Ah : 0.77 kg (1.70lb)

EABcom Series

5 to 95 Nm (3.7 to 70 ft.lb) - 10 to 900 rpm



A



B



C

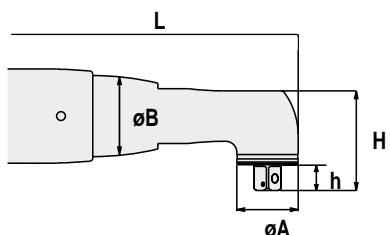

MODEL	L		H		H		ØA		ØB	
	mm	in.	mm	in.	mm	in.	mm	in.	mm	in.
EABC 15-900	470	18.5	10.2	0.40	33.8	1.33	22	0.87	37.0	1.46
EABC 26-560	496	19.5	12.0	0.47	45.7	1.80	28	1.10	37.0	1.46
EABC 32-410	496	19.5	12.0	0.47	45.7	1.80	28	1.10	37.0	1.46
EABC 45-330	506	19.9	12.0	0.47	51.0	2.00	35	1.38	37.0	1.46
EABC 50-450	546	21.5	12.0	0.47	51.0	2.00	35	1.38	37.0	1.46
EABC 60-370	559	22.0	11.9	0.468	57.0	2.20	40	1.57	41.0	1.61
EABC 75-300	582	22.9	17.5	0.69	60.4	2.38	45	1.77	48.5	1.91
EABC 95-240	582	22.9	17.5	0.69	60.4	2.38	45	1.77	48.5	1.91

L = Tool length without battery

NEW eLINK range

Angle head tool with integrated task light
(with LED color code reporting)

Barcode reader ready

Removable cover

Optional accessory
1D/2D/QR
Bar Code Reader
(615 813 038 0)

ACCESSORIES
see page 50-51

PIC REF	MODEL	PART NUMBER EABCOM	PART NUMBER EABCOM eLINK	SQUARE DRIVE	TORQUE RANGE						ROTATIONAL SPEED	WEIGHT WITHOUT BATTERY		VOL-TAGE
					MIN.	RECOM-MENDED	MAX.	MIN.	RECOM-MENDED	MAX.		kg	lb	
				in.	Nm	Nm	Nm	ft.lb	ft.lb	ft.lb	rpm			V

EABcom - TRANSDUCERIZED BATTERY TOOL

•	EABC 15-900	615 165 841 0	615 166 050 0	1/4	5	13	15	3.7	9.6	11	900	1.55	3.42	36
A	EABC 26-560	615 165 842 0	615 166 051 0	3/8	5	24	26	3.7	18	19	560	1.65	3.64	36
A	EABC 32-410	615 165 843 0	615 166 052 0	3/8	7	30	32	5.2	22	24	410	1.65	3.64	36
B	EABC 45-330	615 165 844 0	615 166 053 0	3/8	9	40	45	6.6	30	33	330	1.76	3.88	36
B	EABC 50-450	615 165 845 0	615 166 054 0	3/8	9	45	50	6.6	33	37	450	2.04	4.50	36
B	EABC 60-370	615 165 846 0	615 166 055 0	1/2	10	55	60	7.4	41	44	370	2.35	5.18	36
C	EABC 75-300	615 165 847 0	615 166 056 0	1/2	12	70	75	8.8	52	55	300	2.94	6.48	36
C	EABC 95-240	615 165 848 0	615 166 057 0	1/2	19	90	95	14	66	70	240	2.98	6.57	36

- Battery not included in standard offering
- Battery 36V, 2.5Ah - Weight: 0.77 kg (1.70lb)



Accessories

EABS / BLRTC / EPBcom / EABcom

ACCESSORIES INCLUDED

	EPBcom	BLRTC	EABS
• Protective cover - Black	615 211 019 0	615 211 073 0	Included (7)

OPTIONAL ACCESSORIES

ITEM	EABcom	EPBcom	BLRTC	EABS
Battery type				
1 Li-ion battery pack 18V 2.5 Ah - 0.46 kg (1,01lb)		615 813 266 0	615 813 266 0	615 813 266 0
2 Li-ion battery pack 36V 2.5 Ah - 0,77 kg (1,70lb)	615 813 267 0	615 813 267 0	615 813 267 0	615 813 267 0
Charger				
3 Charger Universal 18 / 36V	615 813 270 0	615 813 270 0	615 813 270 0	615 813 270 0
• Power Cord C13-C14 L=0.3m (daisy chain cable)	615 813 383 0	615 813 383 0	615 813 383 0	615 813 383 0
Protective covers - Tools				
4 For Angle head EAB 15	615 211 003 0			
4 For Angle head EAB 26/32	615 573 207 0			
4 For Angle head EAB 45/50	615 573 208 0			
4 For Angle head EAB 60	615 573 209 0			
4 For Angle head EAB 75/95	615 573 210 0			
5 For Pistol EPB - Red		615 211 022 0		
6 For angle EABS 8 - EABS 12 - EABS 17				615 813 250 0
6 For angle EABS 24				615 813 251 0
Protective covers - Battery				
7 For Battery 18V 2.5Ah - Clear		615 211 136 0	615 211 136 0	615 211 136 0
7 For Battery 18V 2.5Ah - Black		615 211 137 0	615 211 137 0	615 211 137 0
7 For Battery 18V 2.5Ah - Red		615 211 138 0	615 211 138 0	615 211 138 0
7 For Battery 18V 2.5Ah - Grey		615 211 139 0	615 211 139 0	615 211 139 0
7 For Battery 36V 2.5Ah - Clear	615 211 140 0	615 211 140 0	615 211 140 0	615 211 140 0
7 For Battery 36V 2.5Ah - Black	615 211 141 0	615 211 141 0	615 211 141 0	615 211 141 0
7 For Battery 36V 2.5Ah - Red	615 211 142 0	615 211 142 0	615 211 142 0	615 211 142 0
7 For Battery 36V 2.5Ah - Grey	615 211 143 0	615 211 143 0	615 211 143 0	615 211 143 0
Miscellaneous				
8 Nose crowfoot adapter for EPB.		615 565 518 0		
9 eDOCK + Battery data interface	615 813 400 0	615 813 400 0	615 813 400 0	615 813 400 0
10 Barcode reader for EPBC (1D/2D/QR)		615 812 281 0		
• Barcode reader for EABC-eLINK (1D/2D/QR)	615 813 038 0			
• Access point Wifi 802.11N-US:	615 811 417 5	615 811 417 5	615 811 417 5	615 811 417 5
• Access point Wifi 802.11N-EU:	615 811 419 5	615 811 419 5	615 811 419 5	615 811 419 5
• Access point Wifi 802.11N-A	615 811 650 5	615 811 650 5	615 811 650 5	615 811 650 5
• Access point Wifi 802.11N-H	615 811 420 5	615 811 420 5	615 811 420 5	615 811 420 5
• Plug UK	615 917 202 0	615 917 202 0	615 917 202 0	615 917 202 0
11 Side handle		615 397 016 0		
Virtual Cable				
12 Tracking Base	615 813 335 0	615 813 335 0	615 813 335 0	615 813 335 0
13 Tracker	615 813 259 0	615 813 260 0	615 813 260 0	615 813 415 0
• PoE Injector 30W	615 813 263 0	615 813 263 0	615 813 263 0	615 813 263 0
Desoutter Tool holster				
14 DTH TWIN (single) without rail	615 811 411 0			615 811 411 0
15 DTH TWIN rail kit with 2 Twin holders	615 811 412 5			
16 DTH TWIN stand kit with 2 Twin holders	615 811 413 5			
17 DTH90		615 812 119 0	615 812 119 0	
18 DTH Battery (single) without rail	615 813 385 0			615 813 385 0
Suspension				
19 Swivelling front suspension kit	615 397 413 0			615 813 405 0
20 EABS back suspension				615 813 296 0



Accessories

Front trigger for open crowfoot applications

OPTIONAL ACCESSORIES



ITEM		EABcom
Front trigger for open crowfoot applications		
20	Mechanical kit for tools for EABC tools (must be mounted on tool by authorized Desoutter service technician)	615 398 530 0
20	Kit FLEX FRONT START for EABC15 to EABC45	615 911 034 5
20	Kit FLEX FRONT START for EABC50 to EABC95	615 911 033 5

Virtual controllers management (CVI3 VIsion)



	PART NUMBER	Maximum number of tools	Maximum number of		
			cable tools	Battery tools	
21	without ePOD	-	2	1	1
21	ePOD2C	615 936 311 0	3	1	2
21	ePOD3C	615 936 318 0	3	1	3
21	ePOD4C	615 936 312 0	4	1	4



The new standard of Value in Efficient Tightening...

In an era of FLEXIBLE manufacturing and the race to ZERO-fault assembly, Desoutter is proud to introduce the new standard of Value in Efficient Tightening for safety-critical applications: CVI3 assembly system.

This new system offers unequalled EFFICIENCY for all plants thanks to the best combination of advanced process control, easy integration, user-friendly interface & unmatched flexibility.

The CVI3 system integrates UNIQUE added value INNOVATIONS:
Reduce rework cost: complete station process control including tightening

& logical operations without need for a dedicated PLC > **Assembly Process**
Decrease installation/re-balance cost: Fast & easy line re-balancing with multiple Battery transducerized tools connected to 1 CVI3 controller > **EAB cordless tools.**

Improve quality with intuitive software: User-friendly & visual interface to view tightening data & detect quality issues > **CVI ANALYZER.**

Optimize flexibility: 2 fixtured spindles synchronized or asynchronous in standard > **TWINCVI3.**



ADVANCED PROCESS CONTROL



EASY INTEGRATION



UNMATCHED FLEXIBILITY



USER-FRIENDLY INTERFACE

Technical features

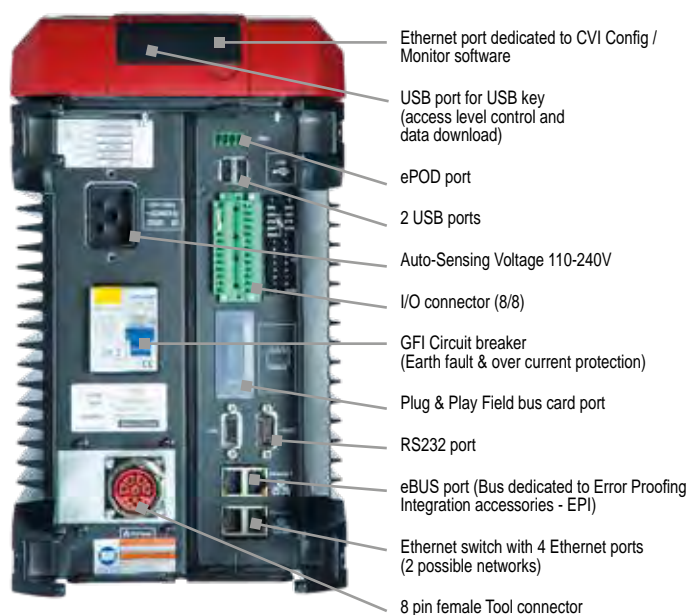

CVI3 Function / CVI3 Essential

CVI3 Vision

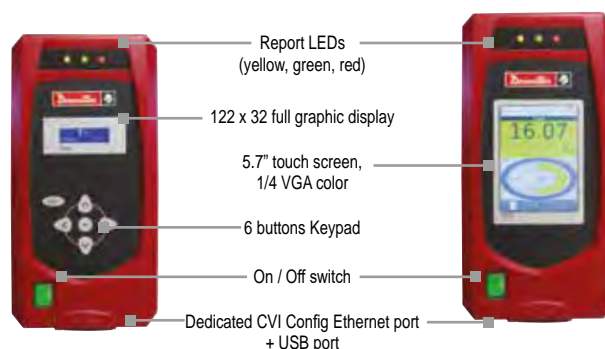

FEATURES	CVI3 ESSENTIAL	CVI3 FUNCTION	CVI3 VISION	TWINCVI3 SYNCHRO/ASYNCHRO
----------	----------------	---------------	-------------	---------------------------

CONTROLLERS

Weight - kg (lbs)	9.3 (20.5)	9.3 (20.5)	9.3 (20.5)	15 (33.1)
Volume (dm ³)	19.5	19.5	19.5	29.6
Color touchscreen			✓ (5.7")	✓ (5.7")

STORAGE

Pset results (torque, angle, date, time, report)	10000 (Only OK/NOK)	10000	10000	10000/20000
Pset curves (OK/NOK)		20	20	20/40
Assembly Process results	1000 (Only OK/NOK)	1000	1000	1000/2000
Event log storage (number of events)	500	500	500	500

BASIC FUNCTIONS

Nbr of Psets	6	250	250	250
Nbr of steps per Pset	15	15	15	15
Barcode reading (standard and 2D)	✓	✓	✓	✓
Quick Pset	✓	✓	✓	✓
Tube nut release	✓	✓	✓	✓

ADVANCED FUNCTIONS

Access Level Control/Management with unlimited profiles	✓	✓	✓	✓
ID input to select Assembly Process (up to 10 different identifiers)	✓	✓	✓	✓
Number of Assembly Process	6	250	250	250
Advanced Soft PLC (in option with CVILOGIX, ePod Essential, ePod2C (min.) is required)	✓	✓	✓	✓
1 Network/Fieldbus Access point per group of up to 14 tools			✓	✓
Full synchronized control for a group of up to 14 controllers			✓	✓

TIGHTENING STRATEGIES

Control: torque, angle, torque OR angle, torque AND angle, yield point*, torque rate*, seating detection*	Torque only	✓	✓	✓
Monitoring: torque rate*, 2nd part angle, current, slip off, stick slip, time & rundown angle	Angle only	✓	✓	✓

CONNECTIVITY

Configurable I/O	8/8	8/8	8/8	8/8
USB ports (2 + 1 front)	✓	✓	✓	✓
Embedded Ethernet switch (4 ports + 1 front – 2 networks)	✓	✓	✓	✓
Dedicated Bus for integrated positioning management	✓	✓	✓	✓

OPTIONAL FIELDBUS

Plug & Play Fieldbus module port (EthernetIP, ProfiNet A/B/IRT, Modbus TCP, DeviceNet, Profibus, CC-Link)	✓	✓	✓	✓
Configurable fieldbus data mapping	✓	✓	✓	✓

*with cable tools

Controllers



A



B



C



D

PIC REF	MODEL	PART NUMBER	CONSUMPTION (CURRENT)		MAIN SUPPLY	DIMENSIONS			WEIGHT				
			110V	240V		50/60 Hz	WIDTH		HEIGHT		DEPTH		
						mm	in.	mm	in.	mm	in.	kg	lb.
A	CVI3 Vision	615 932 691 0	8A	4A	Single-phase	175	6.9	361	14.2	310	12.2	9.3	20.5
A	CVI3 Vision eSTOP	615 932 694 0	8A	4A	Single-phase	175	6.9	361	14.2	310	12.2	9.3	20.5
B	TWINCVI3	615 932 697 0	16A	8A	Single-phase	265	10.4	361	14.2	310	12.2	15	33.1
B	TWINCVI3 eSTOP	615 932 698 0	16A	8A	Single-phase	265	10.4	361	14.2	310	12.2	15	33.1
C	CVI3 Function	615 932 690 0	8A	4A	Single-phase	175	6.9	361	14.2	310	12.2	9.3	20.5
C	CVI3 Function eSTOP	615 932 693 0	8A	4A	Single-phase	175	6.9	361	14.2	310	12.2	9.3	20.5
D	CVI3 Essential	615 932 695 0	8A	4A	Single-phase	175	6.9	361	14.2	310	12.2	9.3	20.5

CVIMONITOR included with controller: License free remote software for realtime monitoring of results, curves, I/O status, Fieldbus diagnostic, calibration & maintenance indicators

POWER CORD

to be ordered with the controller

PLUG	DESCRIPTION	PART NO.
A	European	615 917 069 0
B	US NEMA 5-15	615 917 060 0
C	US NEMA 5-20	615 917 063 0
D	UK	615 917 070 0
E	Chinese	615 917 061 0



SOFTWARES
see page 76-77, 80-81

OPTIONAL ACCESSORIES

ITEM	PART NO.
------	----------

Fieldbus modules

1	Profibus module	615 927 595 0
2	ProfiNet module (1 port)	615 927 596 0
3	ProfiNet module (2 ports)	615 927 597 0
3	ProfiNet IRT module (2 ports)	615 927 070 0
4	DeviceNet module	615 927 599 0
4	CC-Link module	615 927 598 0
5	EtherNet IP module	615 927 594 0
6	Modbus TCP module	615 927 615 0

ePOD

7	ePOD1	615 936 075 0
7	ePOD2	615 936 076 0
7	ePOD3	615 936 077 0
7	ePOD2C	615 936 311 0
7	ePOD3C	615 936 318 0
7	ePOD4C	615 936 312 0
7	ePOD eCompass	615 936 333 0
7	ePOD Essential	615 936 836 0

Others Accessories

8	Table mounting	615 397 399 5
9	Wall mounting CVI3 Function/Essential/Vision	615 397 631 5
10	Wall mounting TWINCVI3	615 811 897 0
11	Cable with 2 M8 male plugs - 0.5m (1.64ft)	615 917 626 0
	Cable with 2 M8 male plugs - 1m (3.28ft)	615 917 633 0
	Cable with 2 M8 male plugs - 2m (6.56ft)	615 917 634 0
12	Cable with 1 M8 male plugs - 5m (16.40ft)	615 917 635 0

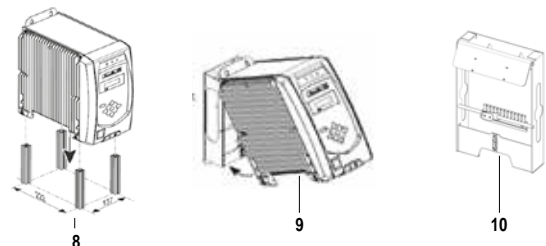

Torque Range - Portable electric nutrunners

Performance of Portable electric nutrunners - EAD, EID, EABC, EPBC, B-LRTC, ERS, ERP and ERP-HT

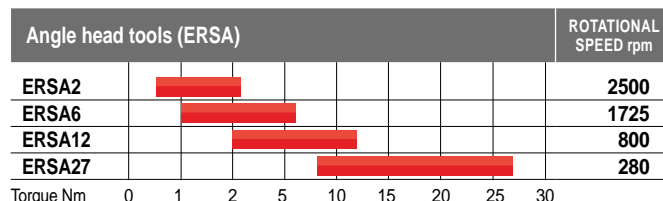
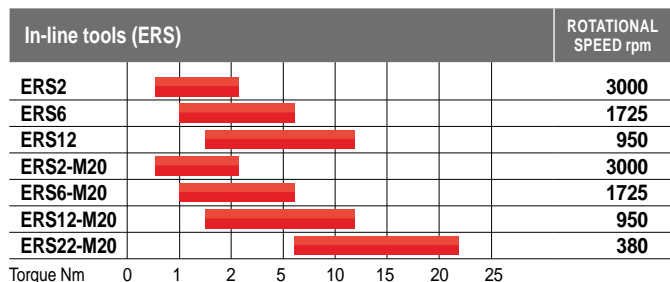
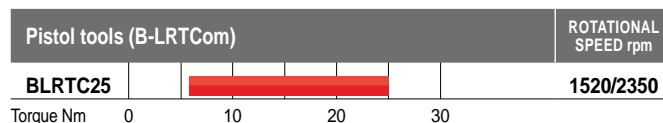
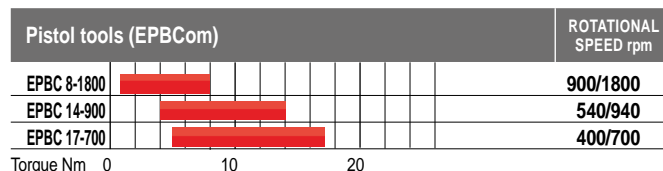
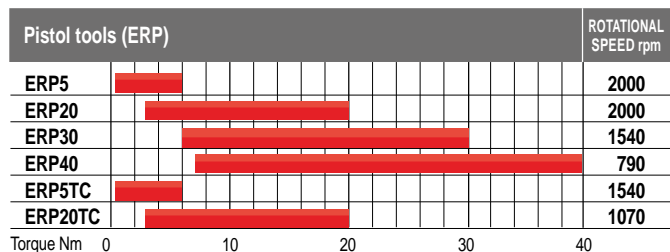
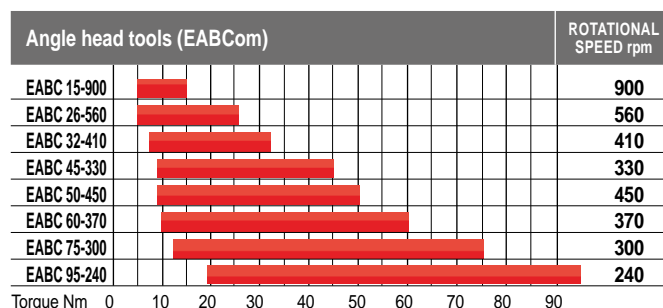
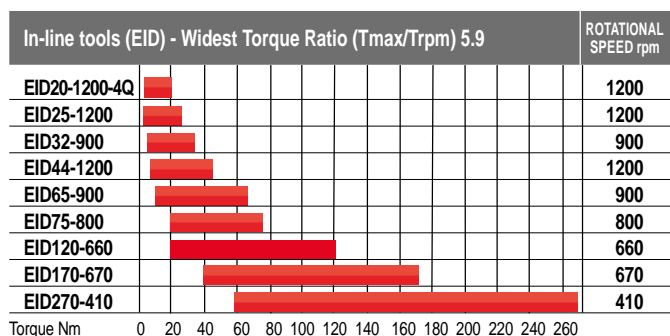
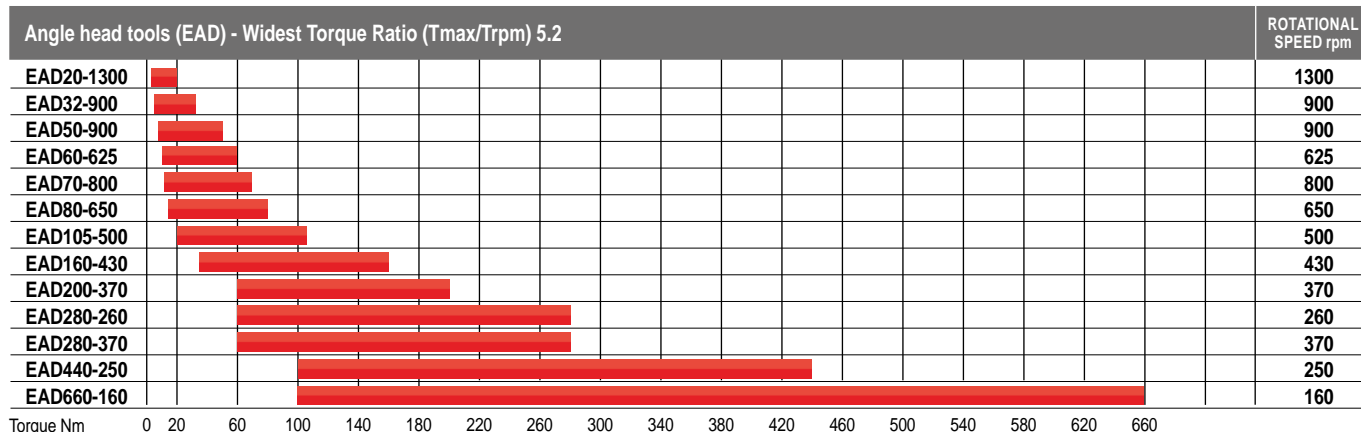

Torque Range - Fixtured electric spindles

Tool connector with 350° rotation in both direction

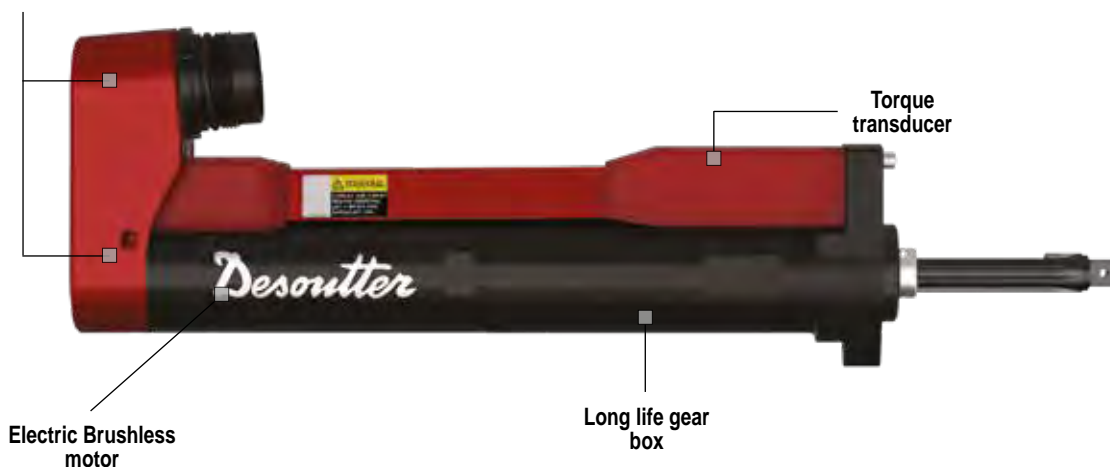

Performance of Fixtured electric spindles - EFD Range

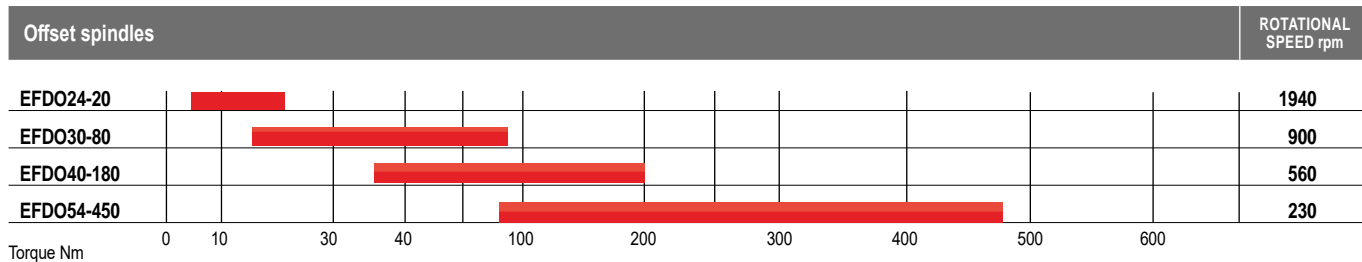
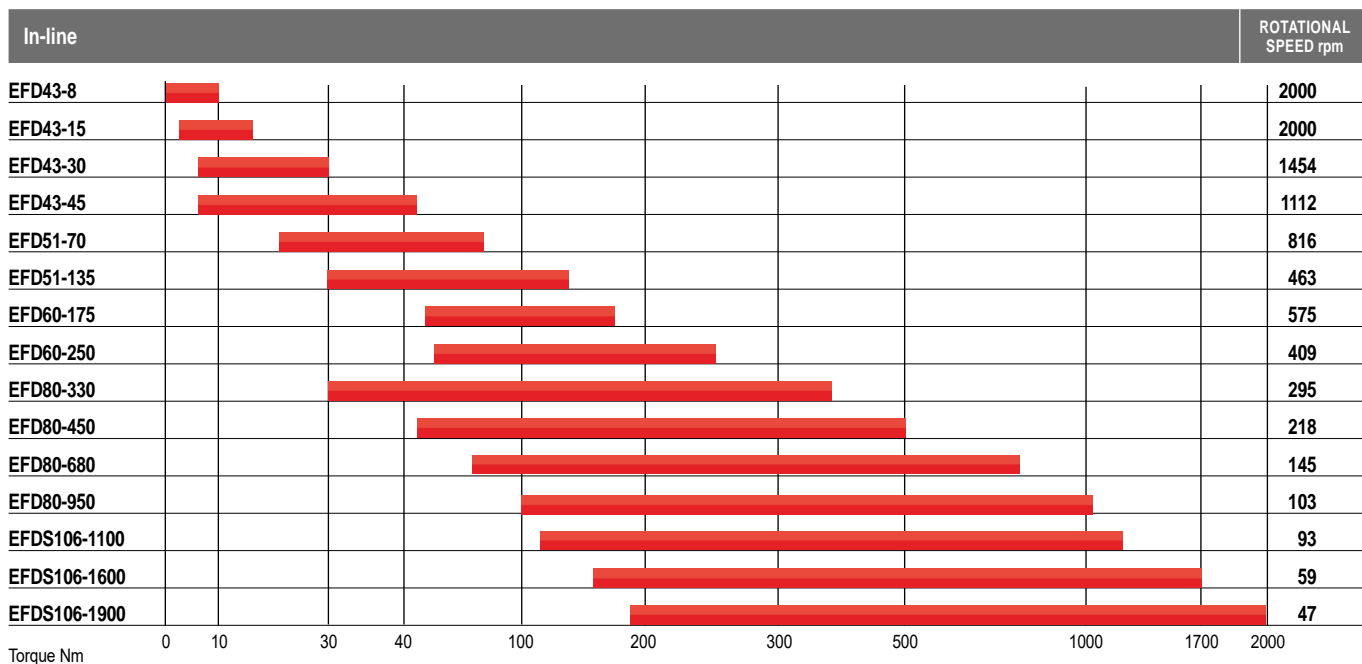

Pistol grip electric nutrunners - CVI3

0.5 to 40 Nm (0.11 to 9 ft.lb) - 680 to 2000 rpm



A



B



C



D



ACCESSORIES
see pages 74-75

CVI II Adapter needed

PIC REF	MODEL	PART NUMBER	OUTPUT DRIVE	TORQUE						ROTATIONAL SPEED	LENGTH		WEIGHT	
				MIN.	RECOM-MENDED	MAX.	MIN.	RECOM-MENDED	MAX.		mm	in.	kg	lb.
			in.	Nm	Nm	Nm	ft.lb	ft.lb	ft.lb	rpm				
A	ERP5	615 166 198 0	Hex. 1/4 F	0.5	5	5	0.11	1.12	1.12	2000	222	8.7	1.1	2.4
B	ERP20	615 166 199 0	Hex. 1/4 F	3	20	20	0.67	4.5	4.5	1540	232	9.1	1.2	2.6
B	ERP30	615 166 200 0	Sq. 3/8	5	30	30	1.12	6.7	6.7	1070	228	9.0	1.2	2.6
C	ERP40	615 165 201 0	Sq. 3/8	6	40	40	1.35	9	9	680	263	10.4	2.1	4.6
D	ERP5TC	615 166 202 0	Hex. 1/4 F	0.5	5	5	0.11	1.12	1.12	2000	248	9.8	2.5	5.5
D	ERP20TC	615 166 203 0	Hex. 1/4 F	3	20	20	0.67	4.5	4.5	1540	258	10.2	2.6	5.7

Electric transducerized High torque - CVI3

75 to 1700 Nm (55 to 1253 ft.lb) - 85 to 822 rpm



The transducerized nutrunners range ERP is dedicated to high torque applications, especially structural assemblies requiring accuracy and traceability.



A



B



C

Complete Loop



ERS / ERPHT Adaptor necessary

PIC REF	MODEL	PART NUMBER	OUTPUT DRIVE	TORQUE RANGE				MAX RUNDOWN TORQUE	SPEED	GEARBOX DIAMETER		LENGHT		WEIGHT		SPLINE
				MIN.	MAX.	MIN.	MAX.			mm	in.	mm	in.	kg	lb	
A	ERP250	615 165 883 0	3/4	75	250	55	184	18	822	54	2.13	355	13.9	5.1	11.2	3
B	ERP500	615 165 884 0	3/4	150	500	110	368	37	347	67	2.64	390	15.3	5.8	12.8	4
C	ERP750	615 165 885 0	1	225	750	165	553	56	245	67	2.64	410	16.1	6.2	13.7	5
C	ERP1000	615 165 886 0	1	300	1000	221	737	75	205	67	2.64	420	16.5	6.4	14.1	5
•	ERP1700	615 165 887 0	1	510	1700	376	1253	127	85	84	3.31	455	17.9	8.3	18.3	9

ACCESSORIES



REACTION BARS	SPLINE	1	2	3	4	5	6	7	8
		STRAIGHT	S-TYPE	L TYPE ALUMINIUM	SQUARE	SLIDING DRIVE	SLIDING DRIVE EXTENDED C-C	SUSPENSION BAIL	SIDE HANDLE
ERP250	3	615 812 097 5	615 812 068 5	615 812 072 5	615 812 057 5	615 812 113 5	N/A	615 812 123 0	615 576 085 0
ERP500	4	615 812 054 5	615 812 069 5	615 812 073 5	615 812 058 5	615 812 062 5	615 812 063 5	615 812 123 0	615 576 085 0
ERP750 / ERP1000	5	615 812 055 5	615 812 070 5	N/A	615 812 059 5	615 812 064 5	615 812 065 5	615 812 123 0	615 576 085 0
ERP1700	9	615 812 056 5	615 812 071 5	N/A	615 812 060 5	615 812 066 5	615 812 067 5	615 812 123 0	615 576 085 0



NUTRUNNER CABLE	PART NO.
Tool cable 3m (9.8ft)	615 917 461 0
Tool cable 5m (16ft)	615 917 462 0
Tool cable 10m (32.8ft)	615 917 464 0
Tool cable 15m (49.2ft)	615 917 465 0



DESCRIPTION	PART NO.
ERS-ERPHT Adaptor	615 936 537 0

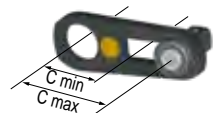

Sliding drive C-C

PART NO.	C MIN	C MAX
	mm (in.)	mm (in.)
615 812 113 5	70 (2.76)	120 (4.72)
615 812 062 5	76 (3)	126 (4.96)
615 812 063 5	82 (3.23)	218 (8.58)
615 812 064 5	80 (3.15)	125 (4.92)
615 812 065 5	82 (3.23)	218 (8.58)
615 812 066 5	80 (3.15)	130 (5.11)
615 812 067 5	80 (3.15)	280 (11.0)

Angle head electric nutrunners - CVI3

3 to 105 Nm (2.2 to 77.4 ft.lb) - 500 to 1300 rpm

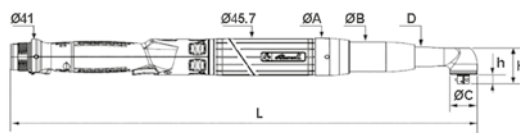

MODEL	h		H		ØA		ØB		ØC		ØD	
	mm	in.	mm	in.	mm	in.	mm	in.	mm	in.	mm	in.
EAD20-1300	12.0	0.47	45.5	1.79	46	1.81	37	1.46	28	1.10	25	0.98
EAD32-900	12.0	0.47	45.5	1.79	46	1.81	37	1.46	28	1.10	25	0.98
EAD50-900	12.0	0.47	51.1	2.01	46	1.81	37	1.46	35	1.38	28	1.10
EAD60-625	12.0	0.47	56.7	2.23	58	2.28	41	1.61	40	1.57	32	1.26
EAD60-625 - 1/2"	12.0	0.47	52.0	2.43	58	2.28	41	1.61	40	1.57	32	1.26
EAD70-800	12.0	0.47	56.7	2.23	58	2.28	43	1.69	40	1.57	32	1.26
EAD70-800 - 1/2"	17.0	0.67	62.0	2.43	58	2.28	43	1.69	40	1.57	32	1.26
EAD80-650	17.5	0.69	60.4	2.38	58	2.28	48	1.89	45	1.77	40	1.57
EAD105-500	17.5	0.69	60.4	2.38	58	2.28	48	1.89	45	1.77	40	1.57



ACCESSORIES
see pages 74-75

MODEL	PART NUMBER	SQUARE DRIVE	TORQUE						ROTATIONAL SPEED	LENGTH		WEIGHT	
			MIN.	RECOM-MENDED	MAX.	MIN.	RECOM-MENDED	MAX.		mm	in.	kg	lb.
		in.	Nm	Nm	Nm	ft.lb	ft.lb	ft.lb	rpm				
EAD20-1300	615 165 606 0	3/8	3	18	20	2.2	13.3	14.8	1300	481	19.2	1.6	3.53
EAD32-900	615 165 607 0	3/8	5	30	32	3.7	22.1	23.6	900	481	19.2	1.6	3.53
EAD50-900	615 165 609 0	3/8	8	45	50	5.9	33.2	40.6	900	531	20.9	2	4.41
EAD60-625	615 166 079 0	3/8	10	55	60	7.4	41	44	625	504	19.8	2.1	4.5
EAD60-625 - 1/2"	615 166 188 0	1/2	10	55	60	7.4	41	44	625	504	19.8	2.1	4.5
EAD70-800	615 165 611 0	3/8	12	65	70	8.9	47.9	51.6	800	544	21.4	2.3	5.07
EAD70-800	615 165 882 0	1/2	12	65	70	8.9	47.9	51.6	800	544	21.4	2.3	5.07
EAD80-650	615 165 612 0	1/2	15	75	80	11.1	55.3	59	650	567	22.3	2.9	6.39
EAD105-500	615 165 613 0	1/2	20	90	105	14.8	66.4	77.4	500	567	22.3	2.9	6.39

Angle head electric nutrunners - CVI3

35 to 660 Nm (26 to 487 ft.lb) - 160 to 430 rpm

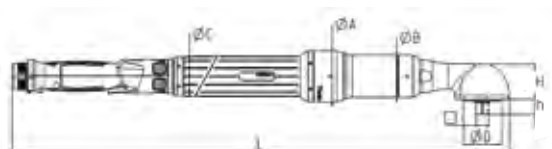

MODEL	h		H		ØA		ØB		ØC		ØD	
	mm	in.	mm	in.	mm	in.	mm	in.	mm	in.	mm	in.
EAD160-430	17.1	0.67	65	2.56	66	2.6	55	2.17	52	2.05	50	1.16
EAD200-370	23	0.91	85	3.35	66	2.6	55	2.17	52	2.05	62	2.44
EAD280-260	23	0.91	85	3.35	66	2.6	55	2.17	52	2.05	62	2.44
EAD280-370	23	0.91	85	3.35	76	2.99	55	2.17	66	2.60	62	2.44
EAD440-250	24	0.94	91	3.58	76	2.99	67	2.64	66	2.60	75	2.95
EAD660-160	33.1	1.3	110	4.33	76	2.99	67	2.64	66	2.60	106	4.17



ACCESSORIES
see pages 74-75

MODEL	PART NUMBER	SQUARE DRIVE	TORQUE						ROTATIONAL SPEED	LENGTH		WEIGHT	
			MIN.	RECOM-MENDED	MAX.	MIN.	RECOM-MENDED	MAX.		mm	in.	kg	lb.
		in.	Nm	Nm	Nm	ft.lb	ft.lb	ft.lb	rpm				
EAD160-430	615 165 681 0	1/2	35	150	160	26	111	118	430	650	25.6	4.3	9.5
EAD200-370	615 165 682 0	3/4	60	170	200	44	125	148	370	673	26.5	5.1	11.2
EAD280-260	615 165 683 0	3/4	60	250	280	44	184	207	260	673	26.5	5.1	11.2
EAD280-370	615 165 684 0	3/4	60	250	280	44	184	207	370	681	26.8	6.1	13.5
EAD440-250	615 165 685 0	3/4	100	400	440	74	295	325	250	735	28.9	8.4	18.5
EAD660-160	615 165 686 0	1	100	600	660	74	443	487	160	774	30.4	11.0	24.3



In-line electric nutrunners - CVI3

3 to 75 Nm (2.2 to 57.5 ft.lb) - 800 to 1200 rpm

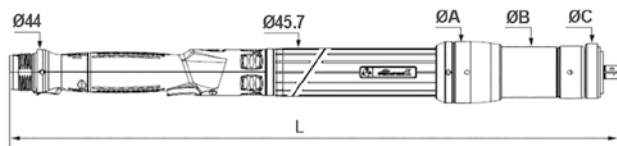

MODEL	ØA		ØB		ØC	
	mm	in.	mm	in.	mm	in.
EID20-1200-4Q	62	2.44	37	1.46	60	2.36
EID25-1200	62	2.44	37	1.46	60	2.36
EID32-900	62	2.44	37	1.46	60	2.36
EID44-1200	62	2.44	48	1.89	54	2.13
EID65-900	58	2.28	48	1.89	54	2.13
EID75-800	58	2.28	48	1.89	54	2.13

ACCESSORIES
see pages 74-75

MODEL	PART NUMBER	OUTPUT DRIVE	TORQUE						ROTATIONAL SPEED	LENGTH		WEIGHT	
			MIN.	RECOM-MENDED	MAX.	MIN.	RECOM-MENDED	MAX.		mm	in.	kg	lb.
		in.	Nm	Nm	Nm	ft.lb	ft.lb	ft.lb	rpm				
EID20-1200-4Q*	615 165 992 0	Hex. 1/4 F	3	18	21	2.2	13.3	15.5	1200	430	16.9	1.45	3.20
EID25-1200*	615 165 614 0	Sq. 3/8	3	20	25	2.2	14.8	18.4	1200	430	16.9	1.45	3.20
EID32-900*	615 165 615 0	Sq. 3/8	5	30	32	3.7	22.1	25.1	900	430	16.9	1.45	3.20
EID44-1200*	615 165 616 0	Sq. 3/8	7	40	44	5.2	29.5	33.2	1200	489	19.3	2	4.41
EID65-900	615 165 617 0	Sq. 1/2	10	60	65	7.4	44.3	47.9	900	489	19.3	2	4.41
EID75-800	615 165 618 0	Sq. 1/2	20	70	75	14.8	51.6	57.5	800	489	19.3	2	4.41

(*): Tools mounted with second lever start in standard

In-line electric nutrunners - CVI3

20 to 270 Nm (15 to 199 ft.lb) - 410 to 670 rpm



MODEL	ØA		ØB		ØC		ØD	
	mm	in.	mm	in.	mm	in.	mm	in.
EID120-660	66	2.60	55	2.17	52	2.05	42.0	1.65
EID170-670	72	2.83	55	2.17	66	2.60	42.0	1.65
EID270-410	76	2.99	67	2.64	66	2.60	53.5	2.11

ACCESSORIES
see pages 74-75

MODEL	PART NUMBER	SQUARE DRIVE	TORQUE						ROTATIONAL SPEED	LENGTH		WEIGHT	
			MIN.	RECOM-MENDED	MAX.	MIN.	RECOM-MENDED	MAX.		mm	in.	kg	lb.
		in.	Nm	Nm	Nm	ft.lb	ft.lb	ft.lb	rpm				
EID120-660	615 165 677 0	1/2	20	110	120	15	81	89	660	583	22.9	3.3	7.3
EID170-670	615 165 678 0	1/2	40	150	170	30	111	125	670	591	23.3	4.6	10.1
EID270-410	615 165 679 0	3/4	60	250	270	44	184	199	410	625	24.6	6.1	13.5

Crowfoot and tube nut tools



Offset Closed



Offset Open

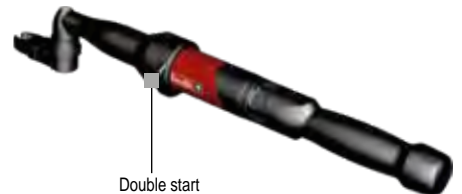

Double start



In line Closed



In line Open

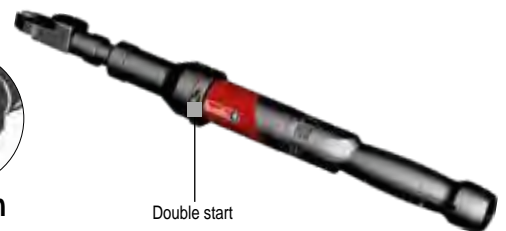

Double start



Flush Socket tools



Hold and Drive tools

Contact your Desoutter representative for assistance in specifying the correct head for your application. We can supply standard products or, if the application requires, we can also provide customized tools.

Standard Tightening Solutions with SALTUS

Geared Front Attachments

The Desoutter tightening solutions with SALTUS Geared front attachment includes a range of Closed-ended crowfoots, Open ended Crowfoots & 110° Angle Heads offering best-in class performance, quality and reliability for the most demanding applications.

The patented designs of SALTUS Geared front attachment provides the market leading efficiency & accuracy, and the optimal integration with the Desoutter tool range delivers the most ergonomic and durable solution for high-class tightening.

Torque range:

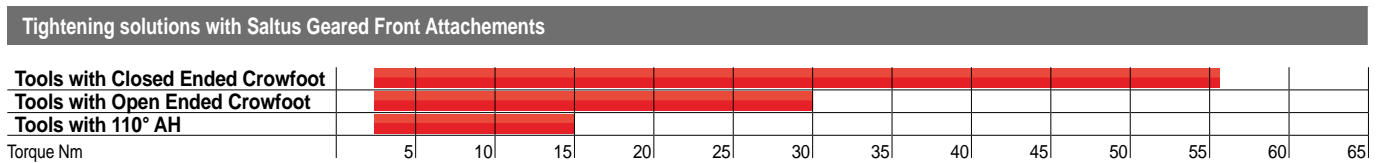

STANDARD TOOL RANGES WITH SALTUS GFAS



	ELECTRIC TRANSDUCERIZED	ELECTRIC CLUTCH TOOL	PNEUMATIC TOOLS
EAD	✓		
EAB	✓		
EPB	✓		
E-LIT		✓	
ERSA	✓		
ECSA	✓		
SD			✓
SH			✓

Standard Tightening Solutions with SALTUS

Geared Front Attachments

Main Features



Standard Tightening Solutions with SALTUS

Geared Front Attachments

Main Features



EXCLUSIVE HIGH-QUALITY STEEL FOR CRITICAL COMPONENTS

For Industry-leading Durability and Efficiency

SAME SOCKET CAN BE ASSEMBLED IN BOTH DIRECTIONS UPWARD AND DOWNWARD

Easy Reconfiguration

H&D SOCKETS AVAILABLE WITH ALL CLOSED ENDED GFAS

No housing difference
Easy Reconfiguration

MAGNET IN CROWFOOT HOUSING

Restricts metallic fragments from entering to the gear mechanism
Improves durability

MODULAR CROWFOOT INTERFACE

Same interface for both fixed and indexing adaptors

INDEXING ENGAGEMENT INDICATOR

Warning indicates that the splines are not engaged

PATENTED THREADED BEARING HOUSING

Ultra-compact design
Improved 1st gear guidance

LOW GEAR MODULES

Better Efficiency
Better Accuracy
Less input torque is required for the same output



Standard Tightening Solutions with SALTUS

Geared Front Attachments

Main Features



BENEFITS

- Compact Solution thanks to optimal integration with Desoutter tools
- High accuracy and Durability
- Better tool Ergonomics
- Hundreds of standard configurations with Desoutter tool ranges are possible to access the most challenging tightening joints



MODEL	PART NUMBER	BASE TOOL / DRIVE UNIT	MAX. OUTPUT TORQUE	MAX. OUTPUT SPEED	TOOL ANGLE HEAD	CROWFOOT TYPE	ADAPTER TYPE	OUTPUT DIMENSION A/F	EXTENSION	BATTERY TYPE
			Nm	rpm				mm		
EAD50-900-OOZRg22h-30-900	6150700108	EAD50-900	30	900	90°	Open Offset	Fixed	14	Flush	-
EAD32-900-OOZMFG29-18-900	6150700110	EAD32-900	18	900	90°	Open Offset	Fixed	10	Flush	-
EAD50-900-COZE4J7Z-31-833	6150700113	EAD50-900	31	833	90°	Closed Offset	Fixed	12	Flush	-
EABC32-410-COZE4E7Z-29-379	6150700116	EABC32-410	29	379	90°	Closed Offset	Fixed	12	Flush	18/36 V

Contact your Desoutter representative for assistance in configuring the right standard solution with SALTUS geared front attachments for your application.

Workgroup System

A multi spindle machine up to 14 fixtured spindles

One **TWINCVI3** or One **CVI3** Vision as a primary controller to synchronize and collect results from all controllers.

Several **TWINCVI3** or/and **CVI3** Vision or/and **CVI3** Function as Secondary controllers.

All connection to the Primary :

- Ethernet network (CVI3 Config, CVI NET Web, Open protocol, HMI, etc...)
- Fieldbus like Profibus, Profinet, Ethernet IP, Devicenet, etc...
- 8 inputs and 8 outputs and much more with I/O expander
- eBus for :
 - Operator panel
 - Stack light
 - Socket tray
 - I/O expander

FIXTURED SPINDLES

EFD : straight spindles

EFDO : offset spindles

EFDx-TA : spindle with redundant torque & angle

Fully compatible with EME range via the adaptor

+
BENEFITS

Flexibility thanks to the use of standard controllers with an additional ePod3
Synchronization of the controllers via the integrated Ethernet network

ACCESSORIES	PART NO.
Cables for EFDx tools	
Tool cable 1m (3.28ft)	615 917 650 0
Tool cable 2.5m (8.2ft)	615 917 651 0
Tool cable 5m (16ft)	615 917 652 0
Tool cable 10m (32.8ft)	615 917 654 0
Tool cable 15m (49.2ft)	615 917 655 0
Extension cable	
Extension cable 8m (26.2ft)	615 917 581 0
Extension cable 16m (52.5ft)	615 917 584 0
Extension cable 32m (105ft)	615 917 587 0
Extension cable 50m (164ft)	615 917 589 0
Miscellaneous	
Spare transducer cable length 340mm (13.4")	615 917 426 0



Workgroup System

CVI3
suite



CVI
CONFIG
CVI
ANALYZER
CVI
NET WEB
CVI
KEY



Advanced tightening strategies

- Optimization of tightening via CVI Config
- Torque and/or Angle control
- Yield point
- Redundant T & A transducer
- Advanced Seating Detection



FACTORY ETHERNET NETWORK

INTERNAL ETHERNET NETWORK

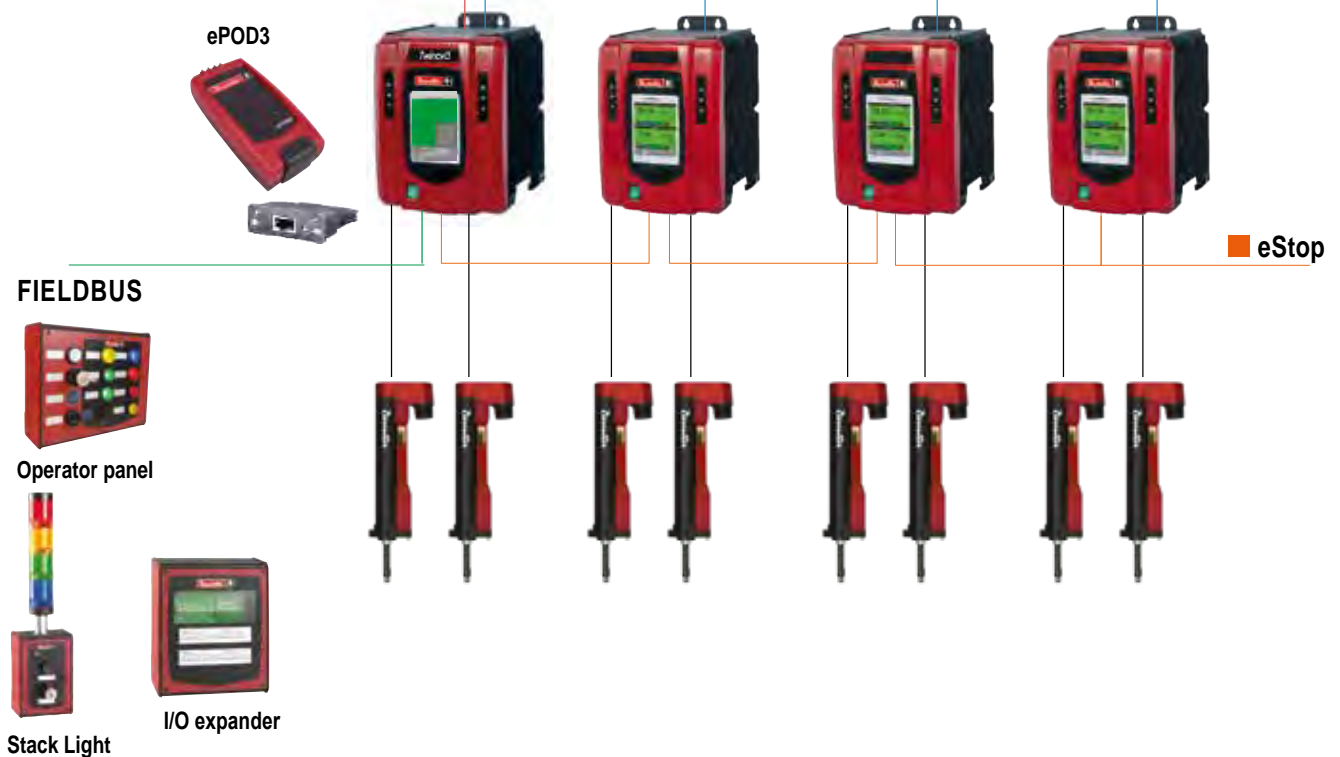

Advanced monitoring

- The primary controller displays all tightening results and events and its own tightening curves.
- Each controller displays its own results

Advanced Process control

- Multi tightening programs, 250 Psets with 40 steps, for all spindles or per group of spindles, action/retry in case of NOK.
- Assembly Process to manage multi Pset and simple processes.
- A soft PLC (CVI Logix) is integrated for more complex processes

Fixtured electric spindles - CVI3

1 to 2000 Nm (0.7 to 1475 ft.lb) - 47 to 2000 rpm

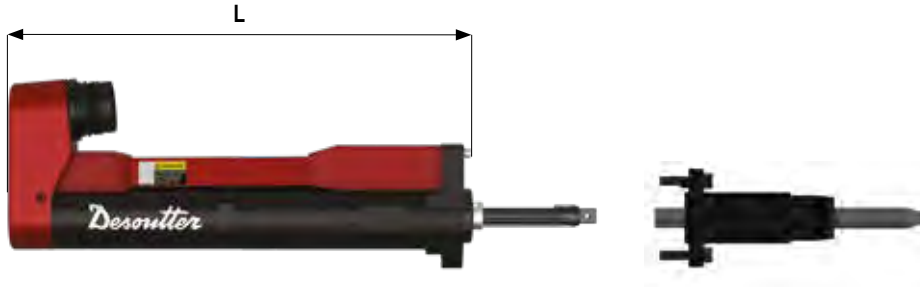

MODEL	LENGTH TOOL-L		WEIGHT TOOL	
	mm	in.	kg	lb.
EFD43-8	276	10.9	2.1	4.6
EFD43-15	276	10.9	2.1	4.6
EFD43-30	311	12.2	2.3	5.1
EFD43-45	311	12.2	2.3	5.1
EFD51-70	357	14.0	3.9	8.6
EFD51-135	357	14.0	3.9	8.6
EFD60-175	373	14.7	5.3	11.7
EFD60-250	373	14.7	5.3	11.7
EFD80-330	435	17	10.2	22.5
EFD80-450	435	17	10.2	22.5
EFD80-680	435	17	10.2	22.5
EFD80-950	435	17	10.2	22.5
EFDS106-1100	476	19	15.3	33.7
EFDS106-1600	511	20	15.9	35
EFDS106-1900	511	20	15.9	35

TELESCOPIC MODULES (OPTION)	PART NO.	LENGTH		WEIGHT	
		mm	in.	kg	lb.
Telescopic Module 3/8" EFx43 IP54	615 397 013 5	165	6.50	0.75	1.65
Telescopic Module 1/2" EFx51 IP54	615 397 017 5	183	7.20	1.55	3.42
Telescopic Module 3/4" EFx60 IP54	615 397 014 5	203	7.99	1.95	4.3
Telescopic Module 3/4" EFx80 IP54	615 399 267 0	398	15.67	9.6	21.16
Telescopic Module 1" EFx80 IP54	615 399 268 0	406	15.98	9.6	21.16
Telescopic Module 1" EFx106 IP54	615 399 296 0	446	17.56	14.1	31.08
Telescopic Module 1 1/2" EFx106 IP54	615 399 270 0	467	18.39	14.1	31.08

ACCESSOIRES
see page 74

MODEL	PART NUMBER	SQUARE DRIVE	TORQUE						ROTATIONAL SPEED	TELESCOPIC STROKE		MIN. CENTRE DISTANCE	
			MIN.	RECOM-MENDED	MAX.	MIN.	RECOM-MENDED	MAX.		mm	in.	mm	in.
			Nm	Nm	Nm	ft.lb	ft.lb	ft.lb		rpm	mm	in.	mm
EFD43-8	615 166 204 0	3/8	1	8	10	0.7	5.9	7.4	2000	50	1.97	43	1.69
EFD43-15	615 166 205 0	3/8	3	15	17	2.2	11.1	12.5	2000	50	1.97	43	1.69
EFD43-30	615 166 206 0	3/8	7	30	32	5.2	22.1	23.6	1454	50	1.97	43	1.69
EFD43-45	615 166 207 0	3/8	7	45	50	5.2	33.2	36.9	1112	50	1.97	43	1.69
EFD51-70	615 166 208 0	1/2	20	70	80	14.7	51.6	59	816	50	1.97	51	2.01
EFD51-135	615 166 209 0	1/2	30	135	150	22.1	99.6	111	463	50	1.97	51	2.01
EFD60-175	615 166 211 0	3/4	50	175	190	36.9	129	140	575	50	1.97	60	2.36
EFD60-250	615 166 212 0	3/4	55	250	280	40.6	184	206	409	50	1.97	60	2.36
EFD80-330	615 166 213 0	3/4	30	330	360	22.1	243.4	265.5	299	60	1.97	80	3.15
EFD80-450	615 166 214 0	3/4	45	450	500	33.2	331.9	368.8	218	60	1.97	80	3.15
EFD80-680	615 166 215 0	1	70	680	740	51.6	501.5	545.8	145	60	1.97	80	3.15
EFD80-950	615 166 216 0	1	100	950	1050	73.8	700.7	774.4	103	60	1.97	80	3.15
EFDS106-1100	615 166 037 0	1	110	1100	1150	81.1	811.3	848.2	93	60	1.97	106	4.17
EFDS106-1600	615 166 038 0	1 1/2	160	1600	1700	118.0	1180.1	1253.9	59	60	1.97	106	4.17
EFDS106-1900	615 166 039 0	1 1/2	190	1900	2000	140.1	1401.4	1475.1	47	60	1.97	106	4.17

Fixtured electric spindles - CVI3

5 to 250 Nm (0.7 to 206 ft.lb) - 409 to 2000 rpm

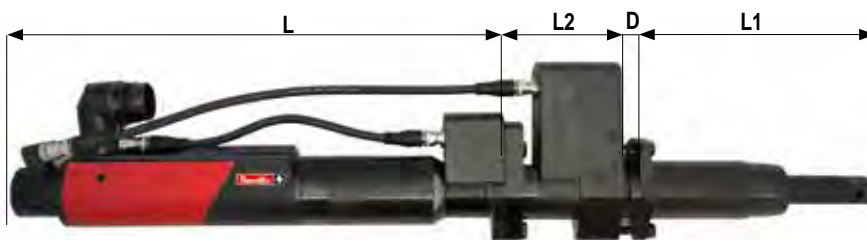

A

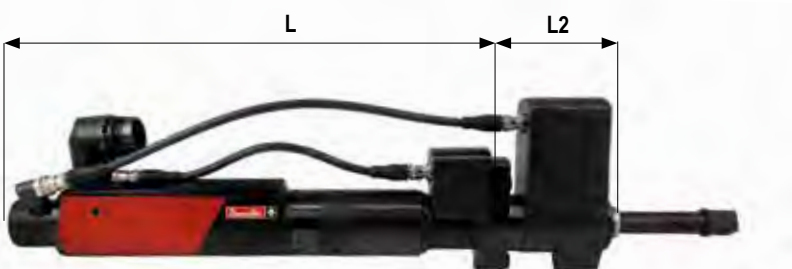

B

MODEL	LENGTH						D		WEIGHT					
	TOOL-L		MODULE-L1		MODULE-L2				TOOL		MODULE		MODULE TA	
	mm	in.	mm	in.	mm	in.	mm	in.	kg	lb.	kg	lb.	kg	lb.
EFDE/EFDS 43-8-TA	318.2	12.53	165	6.5	90	3.54	10	0.39	2.1	4.63	0.65	1.43	1.45	3.20
EFDE/EFDS 43-15-TA	318.2	12.53	165	6.5	90	3.54	10	0.39	2.1	4.63	0.65	1.43	1.45	3.20
EFDE/EFDS 43-30-TA	354	13.94	165	6.5	90	3.54	10	0.39	2.3	5.07	0.65	1.43	1.45	3.20
EFDE/EFDS 43-45-TA	354	13.94	165	6.5	90	3.54	10	0.39	2.3	5.07	0.65	1.43	1.45	3.20
EFDE/EFDS 51-70-TA	401	15.79	183	7.2	98	3.86	16	0.63	3.9	8.60	1.45	3.20	2	4.41
EFDE/EFDS 51-135-TA	401	15.79	183	7.2	98	3.86	16	0.63	3.9	8.60	1.45	3.20	2	4.41
EFDE/EFDS 60-95-TA	419	16.5	183	7.2	98	3.86	16	0.63	5.3	11.7	1.45	3.20	2.8	6.17
EFDE/EFDS 60-175-TA	419	16.5	203	8.0	98	3.86	16	0.63	5.3	11.7	1.87	4.12	2.8	6.17
EFDE/EFDS 60-250-TA	419	16.5	203	8.0	98	3.86	16	0.63	5.3	11.7	1.87	4.12	2.8	6.17



ACCESSOIRES
see page 74

PIC REF	MODEL	PART NUMBER	SQUARE DRIVE	TORQUE						ROTATIONAL SPEED	TELESCOPIC STROKE		MIN. CENTRE DISTANCE	
				MIN.	RECOM-MENDED	MAX.	MIN.	RECOM-MENDED	MAX.		mm	in.	mm	in.
				in.	Nm	Nm	Nm	ft.lb	ft.lb		ft.lb	rpm	mm	in.

EFDE-TA – With removable telescopic module & second transducer

A	EFDE 43-8-TA	615 166 001 0	3/8	5	8	10	3,7	5,9	7,4	2000	50	1.97	43	1,69
A	EFDE 43-15-TA	615 166 002 0	3/8	5	15	17	3,7	11,1	12,5	2000	50	1.97	43	1,69
A	EFDE 43-30-TA	615 166 003 0	3/8	7	30	32	5,2	22,1	23,6	1454	50	1.97	43	1,69
A	EFDE 43-45-TA	615 166 004 0	3/8	7	45	50	5,2	33,2	36,9	1112	50	1.97	43	1,69
A	EFDE 51-70-TA	615 166 005 0	1/2	20	70	80	14,7	51,6	59,0	816	50	1.97	51	2,01
A	EFDE 51-135-TA	615 166 006 0	1/2	30	135	150	22,1	99,6	111,0	463	50	1.97	51	2,01
A	EFDE 60-95-TA	615 166 007 0	1/2	22	95	105	16,2	70,1	77,4	1055	50	1.97	60	2,36
A	EFDE 60-175-TA	615 166 008 0	3/4	50	175	190	36,9	129,0	140,0	575	50	1.97	60	2,36
A	EFDE 60-250-TA	615 166 009 0	3/4	55	250	280	40,6	184,0	206,0	409	50	1.97	60	2,36

EFDS-TA – With integrated telescopic output & second transducer

B	EFDS 43-8-TA	615 166 010 0	3/8	5	8	10	3,7	5,9	7,4	2000	50	1.97	43	1,69
B	EFDS 43-15-TA	615 166 011 0	3/8	5	15	17	3,7	11,1	12,5	2000	50	1.97	43	1,69
B	EFDS 43-30-TA	615 166 012 0	3/8	7	30	32	5,2	22,1	23,6	1454	50	1.97	43	1,69
B	EFDS 43-45-TA	615 166 013 0	3/8	7	45	50	5,2	33,2	36,9	1112	50	1.97	43	1,69
B	EFDS 51-70-TA	615 166 014 0	1/2	20	70	80	14,7	51,6	59,0	816	50	1.97	51	2,01
B	EFDS 51-135-TA	615 166 015 0	1/2	30	135	150	22,1	99,6	111,0	463	50	1.97	51	2,01
B	EFDS 60-95-TA	615 166 016 0	1/2	22	95	105	16,2	70,1	77,4	1055	50	1.97	60	2,36
B	EFDS 60-175-TA	615 166 017 0	3/4	50	175	190	36,9	129,0	140,0	575	50	1.97	60	2,36
B	EFDS 60-250-TA	615 166 018 0	3/4	55	250	280	40,6	184,0	206,0	409	50	1.97	60	2,36

Fixtured offset electric spindles - CVI3

4 to 480 Nm (2.9 to 352.9 ft.lb) - 230 to 1940 rpm



PIC REF	MODEL	PART NUMBER	SOCKET HOLDER	STROKE	TORQUE						FREE SPEED	C-C DISTANCE		TOOL LENGTH		WEIGHT	
					MIN.	RECOM-MENDED	MAX.	MIN.	RECOM-MENDED	MAX.		mm	in.	mm	in.	kg	lb
			in.	mm	Nm	Nm	Nm	ft.lb	ft.lb	ft.lb	rpm	mm	in.	mm	in.	kg	lb
EFDO																	
A	EFDO24-20	615 166 190 0	3/8	50	4	20	22	2.9	14.7	16.2	1940	24	0.94	350	13.78	3.1	6.83
B	EFDO30-80	615 166 191 0	1/2	50	16	80	90	5.9	58.8	66.2	900	30	1.18	450	17.72	5.5	12.12
C	EFDO40-180	615 166 192 0	3/4	50	36	180	200	13.2	132.4	147.1	560	40	1.57	485	19.09	8.8	19.40
D	EFDO54-450	615 166 193 0	3/4	50	90	450	480	33.1	330.9	352.9	230	54	2.13	600	23.62	17.2	37.92

Accessories

Cable for ERP / EAD / EID / EFD



CABLE FOR ERP TOOLS	PART NO.
Nutrunner cable 2.5m (8.2ft)	615 917 570 0
Nutrunner cable 5m (16ft)	615 917 492 0
Nutrunner cable 10m (32.8ft)	615 917 494 0
Nutrunner cable 15m (49.2ft)	615 917 495 0

CABLE FOR EAD & EID TOOLS	PART NO.
Tool cable 2.5m (8.2ft)	615 917 601 0
Tool cable 5m (16ft)	615 917 602 0
Tool cable 10m (32.8ft)	615 917 604 0
Tool cable 15m (49.2ft)	615 917 605 0
Tool cable eFLEX 2.5m (8.2ft)	615 917 631 0
Tool cable eFLEX 5m (16.4ft)	615 917 632 0

CABLE FOR EFD RANGE TOOLS	PART NO.
Tool cable 1m (3.28ft)	615 917 650 0
Tool cable 2.5m (8.2ft)	615 917 651 0
Tool cable 5m (16ft)	615 917 652 0
Tool cable 10m (32.8ft)	615 917 654 0
Tool cable 15m (49.2ft)	615 917 655 0

EXTENSION CABLE FOR ERP TOOLS	PART NO.
Extension cable 5m (16ft)	615 917 083 0
Extension cable 10m (32.8ft)	615 917 084 0
Extension cable 15m (49.2ft)	615 917 085 0
Extension cable 20m (65.6ft)	615 917 086 0
Extension cable 25m (82ft)	615 917 087 0
Extension cable 30m (98ft)	615 917 088 0

EXTENSION CABLE FOR EAD - EID - EFD RANGE TOOLS	PART NO.
Ext. cable 8m (26.2ft)	615 917 581 0
Ext. cable 16m (52.5ft)	615 917 584 0
Ext. cable 32m (105ft)	615 917 587 0
Ext. cable 50m (164ft)	615 917 589 0

eBUS CABLE	PART NO.
eBUS cable Shielded 1m (3.3ft)	615 917 607 0
eBUS cable Shielded 3m (9.9ft)	615 917 608 0
eBUS cable Shielded 5m (16.4ft)	615 917 609 0
eBUS cable Shielded 15m (49.2ft)	615 917 610 0
eBUS Termination plug	615 917 625 0

TRANSDUCER HOLDERS FOR EFD TOOLS	PART NO.
3/8" square drive EFD43	615 396 426 0
1/2" square drive EFD51/60-95	615 396 427 0
3/4" square drive EFD60-175/250	615 396 428 0
3/4" square drive EFD80-330/450	615 396 429 0

Accessories



CVI3 Controllers

OPTIONAL ACCESSORIES

ITEM	PART NO.
Controllers	
1	Socket tray with tubes & inserts
	• Socket tray
	• Kit tubes & Inserts for Socket tray
2	Kit tubes & Inserts for Socket tray
3	Bit holder module for Socket tray
4	Bit Tray
5	Operator Panel
6	Stack Light
7	I/O Expander
	• Y cable for RS232 port

615 936 095 0

615 936 071 0

615 398 035 5

615 398 083 5

615 936 080 0

615 936 072 0

615 936 073 0

615 936 074 0

615 917 620 0



Accessories

EAD / EID / ERP / ERPHT

OPTIONAL ACCESSORIES

ITEM		PART NO.
Suspension bail		
8	Swivelling - All tools up to EAD105/EID75	615 397 413 0
8	Swivelling - for tools EAD160/200/280-260 & EID120	615 571 072 0
Front trigger		
9	Mechanical kit for tools EAD20 to EAD105 & EID20 to EID75 (must be mounted on tool by authorized Desoutter service technician)	615 398 530 0
9	Electric kit for EAD20 to EAD32 & EID20 to EID32	615 911 034 5
9	Electric kit for EAD50 to EAD105 & EID44 to EID75	615 911 033 5
Telescopic output for EID tools		
10	3/8" for EID25/32	615 397 811 0
10	3/8" for EID44	615 398 178 0
10	1/2" for EID65/75	615 398 079 0
10	1/2" for EID120/170	615 398 080 0
10	3/4" for EID270/300	615 398 081 0
Telescopic output for EAD / EFDA tools		
11	1/2" for EAD160	615 398 076 0
11	3/4" for EAD200/280 & EFDA63-190	615 398 077 0
11	3/4" for EAD440	615 398 078 0
11	1" for EFDA107-450	615 398 161 0
Angle head protection for EAD tools		
12	For EAD20/32	615 573 207 0
12	For EAD50	615 573 208 0
12	For EAD60/70	615 573 209 0
12	For EAD80/105	615 573 210 0
In-line protection for EID tools		
13	For EID20/25/32	615 573 211 0
13	For EID44/65/75	615 573 212 0
Finger Protection for EAD tools		
14	For EAD20/32	615 397 635 0
14	For EAD50/60	615 397 636 0
14	For EAD70	615 397 637 0
Miscellaneous		
15	Handle lever	615 397 831 0
16	Trigger locker	615 397 842 0
17	Barcode reader + Headlight accessory - EAD/EID	615 812 138 0
18	Headlight accessory - EAD/EID	615 812 139 0
	• Mounting plate for custom arm - EAD160/200/280/440/660	Contact Desoutter
Desoutter Tool Holster		
19	DTH42 (For ERP3/5/10/20/30)	107892
20	DTH90 (For ERP3/5/10/20/30)	615 812 119 0
21	DTH TWIN (single) without rail	615 811 411 0
22	DTH TWIN rail kit with 2 Twin holders	615 811 412 5
23	DTH TWIN stand kit with base & 2 Twin holders	615 811 413 5
	• D53 arms	See page 168
	• TRA telescopic reaction arms	See page 178
	• Balancers	See page 188
ITEM	ADAPTER FOR ERAL/ERDL/ERP/ EME / ERS AND ERP-HT	PART NO.
24	CVI II Tool Adaptor	615 936 070 0
25	ERS-ERPHT Adaptor	615 936 537 0



Set your tools right...

CVI3 & CONNECT Platform

CVI CONFIG

To set any point to point or via network with an intuitive and guided interface.

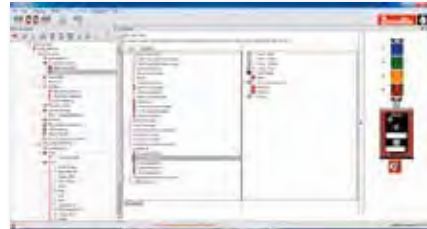

USER-FRIENDLY INTERFACE

- Configurable complete Assembly line view in the tree area
- Easy Tool/PSet setting including Quick Pset
- PSet steps definition with drag & drop feature and Intuitive settings with curve template
- Fast learning curve with contextual help
- Real time error-proofing consistency check

HIGH FLEXIBILITY

- Dynamic mapping for I/O, fieldbus with drag & drop feature
- Including positioning set up
- 2 ways transfer of all parameters between stations & PC
- Complete backup/restore of stations

ASSEMBLY PROCESS

- Complete process logic mapping including tightening & non-tightening operations with Assembly Process

CVI MONITOR

(included in CVI CONFIG) To monitor results, maintenance and diagnostic in real time.

REAL-TIME MONITOR

- Results
- Curves
- Export in csv format
- Real time fieldbus variables monitoring

USER INFO HISTORY

- Alarms history (logs)
- Problem solving guidance

MAINTENANCE

- read the counters of the tools, controller and cables
- set preventive maintenance alarms
- reset the counters and alarms
- tool calibration
- autocalibration with Delta 6D
- Real time access to tool parameters/counters (partial/total number of cycles performed by the tool/cable)
- Test mode to check torque transducer, angle encoder, brushless motor
- Battery tool setup and maintenance

Set your tools right... CVI3 & CONNECT Platform

CVI ANALYZER

To collect tightening data and analyze results thanks to customized filter and report.

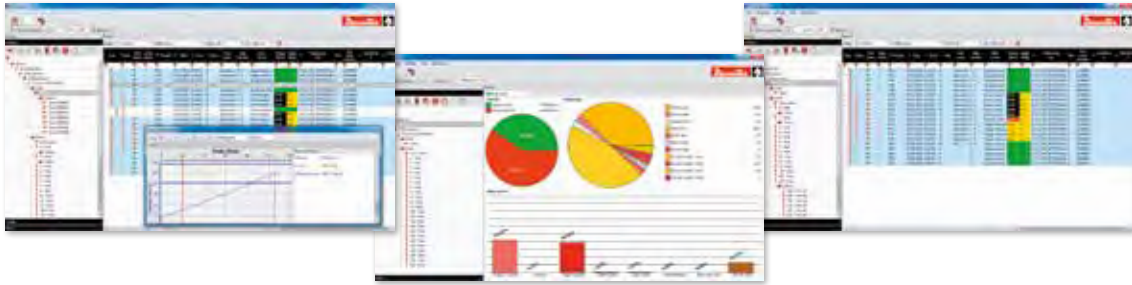

FLEXIBILITY

- Complete Factory and Assembly line layout definition
- Multi User Profiles definition
- Advanced customized filter definition
- Advanced data searching
- Multi tab view

ANALYSIS

- OK/NOK distribution
- NOK distribution reasons analysis

TRACEABILITY

- Unlimited results and curves collection in local DB through plant network
- Complete back-up solution
- Including data import from USB key
- Result and Curve export in csv format

	PART NO.
Software	
CVI ANALYZER - 1 user	615 927 696 0
CVI ANALYZER - 5 users	615 927 697 0
CVI ANALYZER - 25 users	615 927 698 0

CVI KEY

To create & manage tailor-made access rights per user profile.

TAILOR MADE PROTECTION

- Intuitive software to create/manage access level
- Protection guaranteed by unique profile keys created by the administrator (locked against copy)

SIMPLE INTERFACE

- Plug & Play USB key
- 4 profiles already available by default

HIGH FLEXIBILITY

- Unlimited number of profiles
- Set up the right access level



	PART NO.
Software	
CVI KEY	615 927 676 0

Set your tools right...

E-Lit Platform

Manage your E-LIT tools

- Save your E-LIT tool setting
- Use your own tool ID
- Upload saved setting on new tools
- Go further on the setting possibility

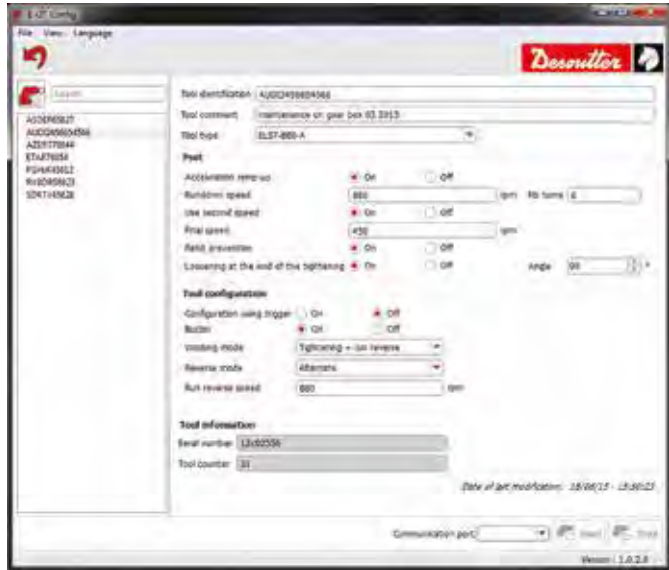

	PISTOL	ANGLE HEAD 18V	ANGLE HEAD 36V	ELC TOOLS	PART NO.
Software					
E-LIT CONFIG software	✓	✓	✓	✓	-
License E-LIT PC Level 1				✓	615 927 685 0

Set your tools right...

Other Platform

CVIPC2000 software is a user friendly tool able to program tightening cycles, collect and display results and curves for other Desoutter controllers platforms.

Programming mode

- General parameters of controllers: peripherals, fieldbuses, ethernet
- Tightening cycles
- Electric brushless tool features
- Downloading of all parameters to stations

Real time control mode on results, tightening reports.

Standard statistical analysis, reports and charts.

Maintenance mode with direct access to tool information, including test mode and complete backup/restore of stations.



The standard CVIPC 2000 is used for point to point connection of a single controller.

The CVIS/CVIC version is used for point to point connection of a single CVIS/CVIC/CVIC-II L and H/CVIL-II controller.

The advanced version is used for multipoint connection of several controllers.

MODEL	PART NUMBER
Reporting to Toolsnet open protocol 1 licence	615 927 829 0
Reporting to Toolsnet open protocol 5 licences	615 927 577 0
Reporting to Toolsnet open protocol 10 licences	615 927 578 0
Reporting to Toolsnet open protocol 25 licences	615 927 579 0
Reporting to Toolsnet open protocol 50 licences	615 927 580 0
Open protocol 1 licence	615 927 830 0
Open protocol 5 licences	615 927 581 0
Open protocol 10 licences	615 927 582 0
Open protocol 25 licences	615 927 583 0
Open protocol 50 licences	615 927 584 0

MODEL	PART NUMBER
CVI PC2000 standard 1 install	615 927 522 0
CVI PC2000 standard 5 install	615 927 526 0
CVI PC2000 standard 25 install	615 927 537 0
CVI PC2000 advanced 1 install	615 927 523 0
CVI PC2000 advanced 5 install	615 927 535 0
CVI PC2000 advanced 25 install	615 927 538 0
CVIPC2000 for CVIS/CVIC 1 Install	615 927 521 0
CVIPC2000 for CVIS/CVIC 2 Install	615 927 534 0

Quality Control and measurement traceability

Delta Quality Control

DELTA QC

The Delta QC software is the common software platform for all Delta QC measurement equipment. Included features are programming, results and curve viewer ensuring measurement data traceability. Statistic machine capability tool or SPC are also ensured thanks to local database available in the Advanced version.

• Delta QC Advanced

Advanced version provides a local result database and offline programming. All results, curves and statistics are available for review, export and reporting in both on line and off line mode. All Tools, Status and Pset are always available in the local SQL DB



Local Database

STATISTIC MANAGEMENT

• Delta QC Licensed



Result and Curve Viewer, Excel EXPORT and PRINTING

Licensed version for on-line device programming and online result export

• Delta QC FreeVersion

Delta Wrench and Alpha D product range are supplied with the Delta QC software. Without any registration the Delta QC is able to program Delta Wrench, Delta D and Alpha D, download results, export to excel and print



MODEL	PART NUMBER
Delta QC Licensed 1 User	615 927 651 0
Delta QC Licensed 5 User	615 927 652 0
Delta QC Advanced 1 User	615 927 653 0
Delta QC Advanced 5 User	615 927 654 0

MAIN FUNCTIONS			
	FREE	LICENSED	ADVANCED
Delta D			
Pset programming	✓	✓	✓
Tool Definition	✓	✓	✓
Route Definition		✓	✓
Transducer Definition	✓	✓	✓
Pset Database		✓	✓
Tool Database		✓	✓
Route Database		✓	✓
Statistic (online only)		✓	✓
Result viewer	✓	✓	✓
Result excel export	✓	✓	✓
Curve viewer		✓	✓
Curve excel, JPEG export		✓	✓
Curve comparison		✓	✓
RESULT Database			✓
Curve Database			✓
Offline statistic			✓

MAIN FUNCTIONS			
	FREE	LICENSED	ADVANCED
QShield-S			
Pset programming	✓	✓	✓
Result viewer	✓	✓	✓
Result excel export	✓	✓	✓
PSet Database		✓	✓
Curve viewer		✓	✓
Result Database			✓

MAIN FUNCTIONS			
	FREE	LICENSED	ADVANCED
Delta Cart			
Pset programming			✓
Pset Database			✓
Result viewer			✓
Result excel export			✓
Result Database			✓
Offline statistic			✓

MAIN FUNCTIONS			
	FREE	LICENSED	ADVANCED
ALPHA D			
Result viewer	✓	✓	✓
Result excel export	✓	✓	✓
Curve viewer		✓	✓

Live data reporting & traceability

Product features

CVI NET WEB

To collect data from controllers and display, in real time, results, statistics and reports on a web based client. Easy interface and configuration. CVI Net Web provides you with a very powerful tool to improve your production follow up.



FULL TRACEABILITY

- Real Time result and curve collection
- Real Time tightening errors
- Data storage in Server architecture
- MS SQL Server, Oracle, MySQL databases
- Automatic uploading of missing data from Controller
- Alarm in case of disconnection and FIFO inside controllers
- Curve overlay

FLEXIBILITY

- Administrator User
- Customized views and Filters
- Groups and Teams management
- Complete Plant layout definition
- Smart Identifier filtering
- Quick VIN result filtering

OPEN PROTOCOL ADAPTER LICENSE

- To collect results from any controller having Open Protocol capability
- To collect results from Delta Wrench WLAN

STATISTICAL ANALYSIS AND DOCUMENTATION

- Advanced OK/NOK reports and control charts
- Advanced NOK pareto analysis
- Cm/Cmk analysis according different standards (ISO, CNOMO, NF)
- Error Code Analysis & CVI3 User Info pareto diagram
- Team productivity report

REPORT PRINTING

- Export all results and curve directly from web page
- PDF, csv or txt export format
- Direct Printing from web page
- Printing of all tightening of a vehicle or a components by scanning the proper bar code
- Assembly Process result and complete report in PDF, xls format

NOTIFIER LICENSE

- To send customized email or on-line notification triggered by specific User Info



Live data reporting & traceability

Product references list



STANDARD LICENSE

to collect results from Desoutter controllers

- CVI Net Web service
- DB scripts to create/update
- MySQL
- SQL Server
- Oracle DB



	PART NO.
Software	
• CVINET WEB - 1 cont.	615 927 736 0
• CVINET WEB - 10 cont.	615 927 737 0
• CVINET WEB - 25 cont.	615 927 738 0
• CVINET WEB - 50 cont.	615 927 739 0
• CVINET WEB - 100 cont.	615 927 747 0
• CVINET WEB - 200 cont	615 927 748 0

OPEN PROTOCOL ADAPTOR

- OP Adapter License to collect results from all Desoutter controllers and tools with Open Protocol communication enabled
- OP Adapter Service to be registered in addition to standard CVI Net Web license

	PART NO.
Software	
• CVINET WEB - Open Protocol Adapter	615 927 758 0

CVI3 USER INFO NOTIFIER

- CVI Net Web allows to receive emails triggered by some events
- On-line notification as email alternative
- Notifier Service to be registered

	PART NO.
Software	
• CVINET WEB - Notifier	615 927 076 0

Pivotware - Process Control

Product features

1 | PROCESS CONTROL



Process Configurator



Customizable, simple and powerful tool to improve your process

2 | OPERATOR GUIDANCE



Infinity Station

Tracker Module

Builder Module

Warranties the best practice on the line, the most efficient way

3 | REPORTS & TRACEABILITY

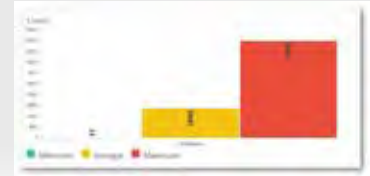

Reports & traceability

Bring confidence to your customers



Fusion Management Suite for configuring stations & processes, deployment control and remote monitoring.



Production Management Module to manage products, sequencing and build requirements in each station.

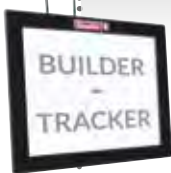

Production Management Module

Structured sequence of work instructions and visual guidance delivered to operator for product variant requirements in station.



Customer Line Control System

Integration with line control systems for data exchange, product in station, line running/start/stop signals and TAKT requirements.

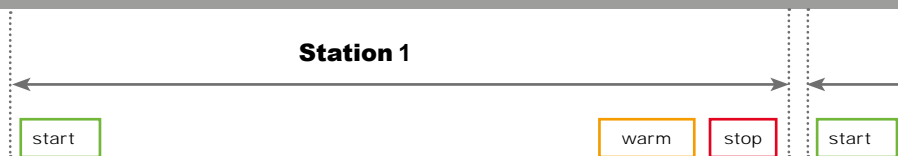

Pivotware - Process Control

Product features

DESOUTTER FEATURE MANAGEMENT



Centralised storage and packaged services to manage collection and synchronisation of data.



Fusion Management Suite for interrogation and analysis of production data and product histories.

Dynamic Tooling option providing up to 8 tools running simultaneously on the workstation.

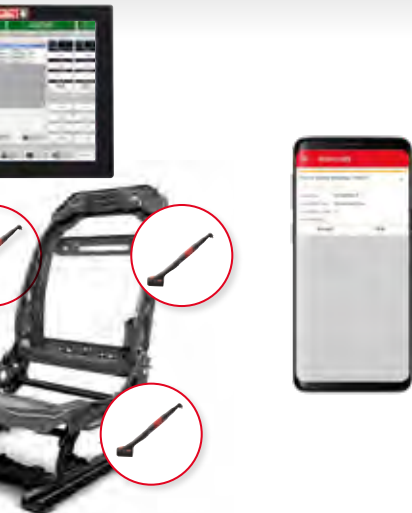

Quality Checking & Repair Station utilising Quality Management System modules & services.



On line rework of missed items using the QMS Shared Step features.

Station 2

Station 3



Station Level TAKT monitoring and management in line with product variant requirements in station.



DEMETER



Pivotware - Process Control

Product references list

HARDWARE

Infinity		PART NUMBER
Prime Infinity One 8Gb	Infinity V7 and higher including Features Management	615 927 867 0
Panel PC's		PART NUMBER
Infinity Panel PC 17"	with Alim, without power cable	615 932 745 0
Infinity Client - Panel PC 17" Windows 10 IoT with pre-loaded client software V6	with Alim, without power cable	615 932 742 0
Infinity Module - Panel PC 17" Windows 10 IoT with pre-loaded Module software V6 (Tracker or Builder)	with Alim, without power cable	615 932 743 0
Accessories		
INFINITY Micro 16I/O with M12 Connector Breakout	with alim without power cable	615 936 324 0
INFINITY/SIGMA Nano Kit	with 2 cables HD15 0,5m and Alim ; without power cable	615 936 327 0
INFINITY Positioning HW USB to CAN kit	1 x kit	615 813 265 0
Kit drive SSD with pre loaded software - spare part - Order with customer center		
Cable HD15 0,5m	Spare part	615 917 664 0
Cables		
Power cord 2m - A - European		615 917 201 0
Power cord 2m - B - USA		615 917 203 0
Power cord 2m - C - UK		615 917 202 0
Power cord 2m - D - Chinese		615 917 206 0

PANEL PC'S

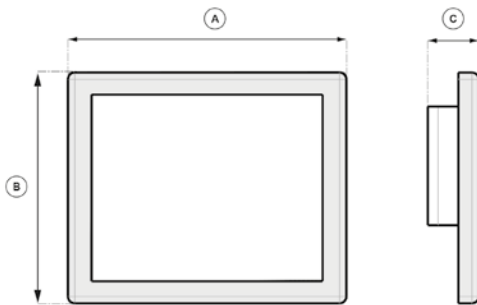

MODEL	A		B		C	
	mm	in.	mm	in.	mm	in.
Infinity Station 17" IOT	410	16.14	341	13.43	69	2.72
Infinity Module 17" IOT	410	16.14	341	13.43	69	2.72

ACCESSORIES



Infinity Micro



Sigma Nano Kit

CABLES

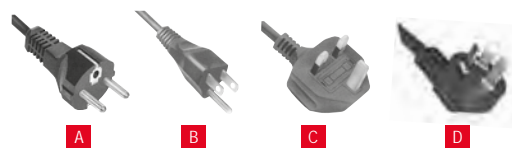

A

B

C

D

Pivotware



Smart Start / Install & set up



Start-up

Digital transformation is the key for industry 4.0. With our software experts and our global presence, we work together to make it happen at your facility.



Software Support / Remote experts



Essential care

Connect to our expert team with Essential Care to make sure your software is always up and running.



- ✓ Support portal
- ✓ Remote support
- ✓ **BOOSTLAB Trial**



Production Boost / On-demand Services



BOOSTLAB

Prescription based on data analytics

Subscribe to BOOSTLAB to get production data analytics and prescriptions to boost efficiency in your plant.



Service Level 2 team is **CONNECTED** and **ONLINE**
 Ask an access to the Support portal **NOW!**
 Build with experts



CVI_x II Range

Transducerized Tools

Handheld Tools

- Brushless AC motor: virtually maintenance free
- Resolver: smooth angle control at any speed
- 6 leds OK / NOK signals

Fixtured electric spindles

- Long life gear boxes
- Brushless motor
- High output torque transducer for a larger torque range



Controllers



Controller - CVIR II

Error proofing and flexibility

Advanced control unit with flexibility and technology

- Easy integration into your assembly line with multiple choices of connectivity



ERS
Transducerized technology

ECS
Current Control Technology

COMMUNICATION

- 1 Ethernet port for CVIPC or network communication
- 1 RS232 port to connect barcode readers or CVIPC 2000
- 8 Inputs and 8 Outputs
- 1 Optional fieldbus module

Innovative Tightening Strategy

Seating detection

Detect the screw head contact on your part by torque rate management, even with material variation

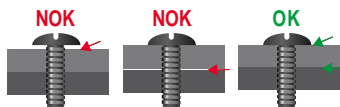

QUALITY GUARANTEED

MODEL	PART NUMBER	TOOLS	CONSUMPTION (CURRENT)		MAINS SUPPLY	DIMENSIONS						WEIGHT	
			115 V	230 V		WIDTH		HEIGHT		DEPTH		kg	lb.
CVIR II	615 932 681 0	ERS/ECS	4A	2A	Single-phase	mm	in.	mm	in.	mm	in.	kg	lb.
						130	5.1	278	10.9	291	11.5	5	11

MAIN FUNCTIONS	CVIR II
Programming modes	
Quick cycle	✓
Learning mode	✓
Number of cycles	50
Number of phases available	15
Phase characteristics	
Search sequence	✓
Approach	✓
Run down speed	✓
Final speed phase	✓
Action on NOK	✓
Run reverse	✓
Jump to another phase	✓
Prevailing Torque	✓
Synchronisation phase	✓
Tightening strategies	
Torque	✓
Torque with angle monitoring	✓
Angle with torque monitoring	✓
Yield point	✓
Seating detection	✓
Number of stored results	2000 to 10000 according configuration

Upgrade kits...

POWER CORD

to be ordered with the controller

PLUG	DESCRIPTION	PART NO.
A	European	615 917 201 0
B	US	615 917 203 0
C	UK	615 917 202 0
D	Chinese	615 917 206 0

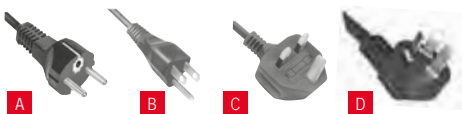

OPTIONAL ACCESSORIES

	PART NO.
• PC cable length 2 m (78.7")	615 917 047 0
• 37 pin D-Sub female I/O adapter	615 919 003 0
• Shelf support - Aluminium profile	615 397 403 5
• BRDx2 (Backup Rescue Device)	615 936 328 0

Fieldbus / Protocol

MODEL	PART NO.
Ethernet IP Module	615 927 594 0
Profibus DP Module	615 927 595 0
ProfiNet Module (1 port)	615 927 596 0
ProfiNet Module (2 ports)	615 927 597 0
CC-Link Module	615 927 598 0
Devicenet Module	615 927 599 0
MODBUS TCP Slave	615 927 615 0

Electric transducerized screwdrivers - CVIR II

0.6 to 27 Nm (5.3 to 239 ft.lb) – 280 to 3000 rpm

The transducerized screwdrivers range ERS is dedicated for all type of tightening which required accuracy and traceability



A



B



C

Visible & Programmable reporting LED System



Good Report



Bad Report



Programmable

Tool Ready, Tool in Cycle, Maintenance Alert, and more.



ACCESSORIES
see page 99

To connect with CVI3 controller, ERS module is needed

PIC REF	MODEL	PART NUMBER	OUTPUT DRIVE	TORQUE				SPEED	WEIGHT	
				MIN. Nm	MAX. Nm	MIN. in/lb	MAX. in/lb		kg	lb
A	ERS2	615 165 688 0	Hex.1/4F	0.6	2.5	5.3	22.1	3000	0.7	1.54
A	ERS6	615 165 689 0	Hex.1/4F	1.0	6.0	8.8	53.1	1725	0.7	1.54
A	ERS12	615 165 690 0	Hex.1/4F	1.5	12	13.3	106.2	950	0.7	1.54
A	ERS2-M20	615 165 691 0	Hex.1/4F	0.6	2.5	5.3	22.1	3000	0.7	1.54
A	ERS6-M20	615 165 692 0	Hex.1/4F	1.0	6.0	8.8	53.1	1725	0.7	1.54
A	ERS12-M20	615 165 693 0	Hex.1/4F	1.5	12	13.3	106.2	950	0.7	1.54
A	ERS22-M20	615 165 916 0	Sq.3/8	6.0	22	53.1	194.7	380	1.05	2.31
B	ERSA2	615 165 697 0	Hex.1/4F	0.6	2.5	5.3	22.1	2500	1.0	2.2
B	ERSA6	615 165 698 0	Hex.1/4F	1.0	6.0	8.8	53.1	1450	1.0	2.2
B	ERSA12	615 165 699 0	Hex.1/4F	2.0	12	17.7	106.2	800	1.0	2.2
B	ERSA27	615 165 917 0	Sq.3/8	8.0	27	70.8	239	280	1.25	2.75
C	ERSF2	615 165 694 0	Hex.1/4F	0.6	2.5	5.3	22.1	3000	0.7	1.54
C	ERSF6	615 165 695 0	Hex.1/4F	1.0	6.0	8.8	53.1	1725	0.7	1.54
C	ERSF12	615 165 696 0	Hex.1/4F	1.5	12	13.3	106.2	950	0.7	1.54
C	*ERSF2-03	615 166 068 0	Hex.1/4F	0.6	2.5	5.3	22.1	3000	0.7	1.54
C	*ERSF6-03	615 166 069 0	Hex.1/4F	1.0	6.0	8.8	53.1	1725	0.7	1.54
C	*ERSF12-03	615 166 070 0	Hex.1/4F	1.5	12	13.3	106.2	950	0.7	1.54

*Models with 30cm integrated cable instead of 4 meters

Electric transducerised Very Low Torque – CVIXS



MAIN FUNCTIONS	
Programming modes	
Quick cycle	✓
Learning mode	✓
Number of cycles	50
Number of phases available	15
Phase characteristics	
Search sequence	✓
Run down speed	✓
Final speed phase	✓
Action on NOK	✓
Run reverse	✓
Jump to another phase	✓
Prevailing Torque	✓
Synchronisation phase	✓
Tightening strategies	
Torque	✓
Torque with angle monitoring	✓
Angle with torque monitoring	✓
Seating detection	✓
Stall torque	✓
Number of stored results	2000 to 10000 according configuration

Controller features

Power Supply

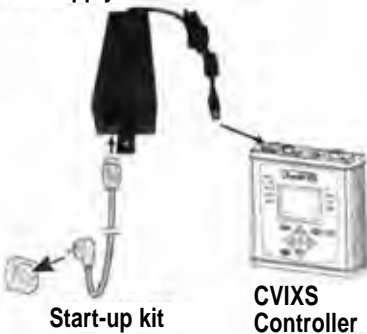

Start-up kit

PLUG	DESCRIPTION	PART NO.
A	European	615 917 201 0
B	US	615 917 203 0
C	UK	615 917 202 0
D	Chinese	615 917 206 0

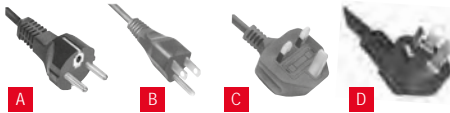

CVIXS supports

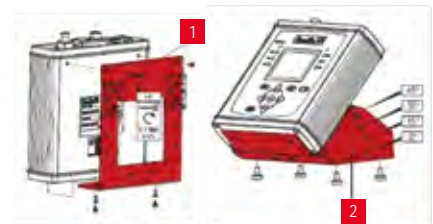

ITEM	DESCRIPTION	PART NO.
1	KIT RAIL DIN SUPPORT CVIXS	615 812 231 0
2	KIT ANGLE SUPPORT CVIXS	615 812 232 0

CVIXS fieldbus communication : order fieldbus module + fieldbus protocol

	MODEL	PART NO.
FIELDBUS PROTOCOL	Ethernet IP Module	615 929 051 0
	Profibus DP Module	615 929 052 0
	ProfiNet Module (1 port)	615 929 053 0
	ProfiNet Module (2 ports)	615 929 054 0
	CC-Link Module	615 929 055 0
	Devicenet Module	615 929 056 0
	MODBUS TCP Slave	615 929 057 0

MODEL	PART NUMBER	TOOLS	CONSUMPTION (CURRENT)	SUPPLY VOLTAGE	DIMENSIONS						WEIGHT	
					WIDTH		HEIGHT		DEPTH		kg	lb.
			W		mm	in.	mm	in.	mm	in.		
CVIXS CONTROLLER	615 932 720 0	ERXS	150	36 VDC	171,6	6,73	171	6,75	54,6	2,15	1,12	2,2
CVIXS POWER SUPPLY	615 932 663 0	CVIXS	72-180	100-240 VAC	65	2,56	50	8,07	50	1,97	0,97	2,13

Electric transducerised Very Low Torque – NANO DRIVER



A

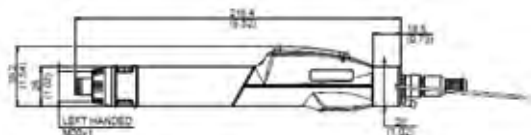

Transducerized tool for Extreme Precision

- 4mm wing shank and half moon bits for the smallest screws
- Safety Critical Repeatability
- Traceability using internal transducer

Ergonomic Design

- Streamlined & contoured
- Non-slip Tool Housing
- Push / Lever start
- Highly Flexible Light Weight Industrial Cable
- M20 output thread for easy integration and automatization

Programmable Vacuum System Activation Options

- Built in Accelerometer
- Dedicated connector for 24V vacuum pump

PIC REF	MODEL	PART NUMBER	OUTPUT DRIVE	TORQUE				MAX SPEED	LENGTH		WEIGHT	
				MIN	MAX	MIN	MAX		mm	in.	kg	lb
				Ncm	Ncm	in/lb	in/lb					
A	ERXS 20	615 165 874 0	WS-HM	6	20	0,53	1,77	1000	216	8,5	0,3	0,66
A	ERXS 50	615 165 875 0	WS-HM	15	50	1,32	4,43	1000	216	8,5	0,3	0,66
A	ERXS 80	615 165 876 0	WS-HM	24	80	2,12	7,08	1000	216	8,5	0,3	0,66

DESCRIPTION	PART NO.
TOOL & EXTENSION CABLE 3 METERS - 9,8 FT*	615 917 643 0

*Connect up to 3 cables (max 9 Meters - 29,5 ft)

ACCESSORIES

ITEM	PART NUMBER
------	-------------

Vacuum solution

1	"Blank nozzle short: 40mm. To be machined according to screw"	615 704 033 0
2	"Blank nozzle long: 60mm. To be machined according to screw"	615 704 034 0
3	"Vaccum adapter kit. For tool handheld. To be ordered with a blank nozzle"	615 812 883 0

Arms

4	D53-5	615 810 700 0
5	D53-5S	615 810 706 0
6	Special clamp	615 812 885 5

Bits

- Refer to accessories section

page 299

Miscellaneous

7	Flange M20 for automatization	205 052 875 3
8	DTH42 Tool holster	107892
9	Cable 2m for Bit Tray	615 917 598 0
•	Cable 2m for Posco 500	615 917 747 0



Controller - CVIL II

Flexible integration

FEATURES	CVIL II
General functions	
Number of cycles	50
Number of phases	15
Batch count	999
Bar code reading via RS232 port	✓
Programming	
LCD screen and display	✓
CVIPC software	✓
Tightening results	
Led "Low", "OK", "High" Torque	✓
Led "Low", "OK", "High" Angle	✓
Torque+Angle+Data+Time+Report	up to 10 000
Number of curves (flexibility with OK and NOK)	10

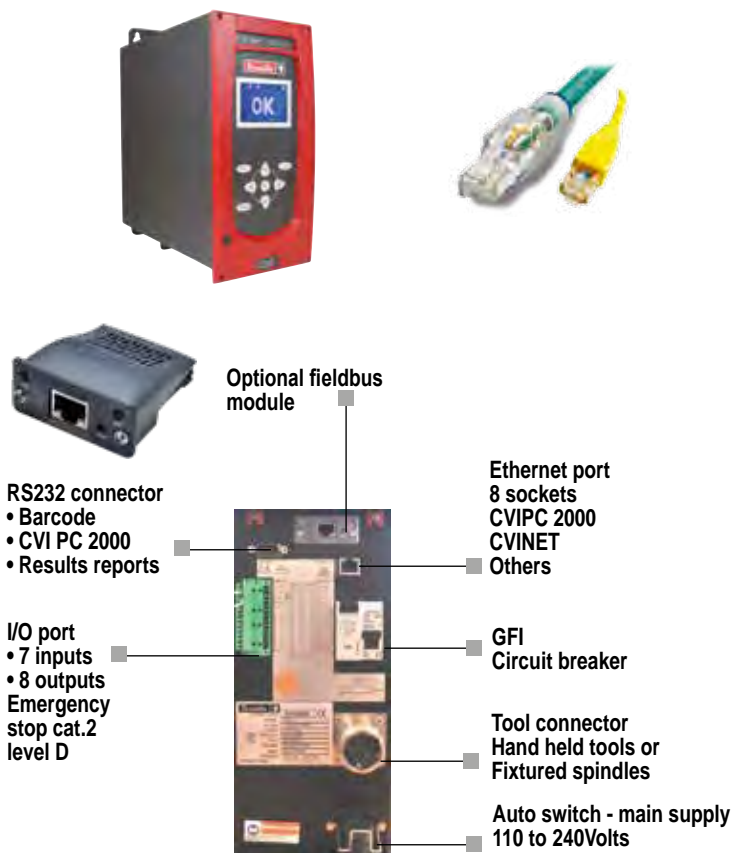

MODEL	PART NUMBER	CONSUMPTION (CURRENT)		MAINS SUPPLY	DIMENSIONS						WEIGHT	
		115 V	230 V		WIDTH		HEIGHT		DEPTH		kg	lb.
CVIL II	615 932 680 0	4A	2A	50/60 hertz	mm	in.	mm	in.	mm	in.	5.9	13

Upgrade kits...

POWER CORD
to be ordered with the controller

PLUG	DESCRIPTION	PART NO.
A	European	615 917 201 0
B	US	615 917 203 0
C	UK	615 917 202 0
D	Chinese	615 917 206 0

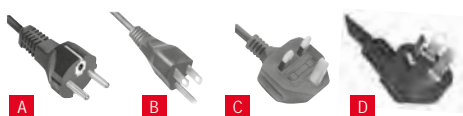

OPTIONAL ACCESSORIES

	PART NO.
• PC cable length 2 m (78.7")	615 917 047 0
• 37 pin D-Sub female I/O adapter	615 919 003 0
• Shelf support - Aluminium profile	615 397 403 5
• BRDx2 (Backup Rescue Device)	615 936 328 0

Fieldbus / Protocol

MODEL	PART NO.
Ethernet IP Module	615 927 594 0
Profibus DP Module	615 927 595 0
ProfiNet Module (1 port)	615 927 596 0
ProfiNet Module (2 ports)	615 927 597 0
CC-Link Module	615 927 598 0
Devicenet Module	615 927 599 0
MODBUS TCP Slave	615 927 615 0

Electric pulse nutrunners - E - PULSE

10 to 50 Nm (7.4 to 36.9 ft.lb) - 4600 rpm



ADVANCED ERGONOMICS

- Reaction free
- Soft grip and slim handle
- Low weight tool

OPTIMIZED MAINTENANCE

- No oil to change
- Brushless electric motor
- Long life gearbox

INCREASED PRODUCTIVITY

- Max. speed 4600 rpm
- Point and shoot solution
- Pistol tool 30 % shorter time to locate bolt

IMPROVED ENVIRONMENT

- Reduce CO2 emission
- Clean workspace
- Reduce energy consumption



A



C



E



B



D



F



ACCESSORIES
see page 99

PIC REF	PART NUMBER	MODEL	OUTPUT DRIVE	OUTPUT RETAINING TYPE	TORQUE				ROTATIONAL MAX SPEED	LENGTH		WEIGHT		INTEGRATED CABLE
					MIN	MAX	MIN	MAX		mm	in.	kg	in.	
					Nm	Nm	ft.lb	ft.lb						
A	615 165 838 0	ELRT025-P4600-10S	Sq. 3/8	Trough hole	10	25	7.4	18.4	4600	228	9.0	1.3	2.9	N/A
B	615 165 890 0	ELRT025-P4600-4Q	Hex. 1/4	Quick change chuck	10	25	7.4	18.4	4600	228	8.7	1.3	2.9	N/A
C	615 166 040 0	ELRT025T-10S-5	Sq. 3/8	Trough hole	10	25	7.4	18.4	4600	255	10.0	2.6	5.7	5 meters
C	615 166 047 0	ELRT25T-10S-1	Sq. 3/8	Trough hole	10	25	7.4	18.4	4600	255	10.0	2.1	4.6	1 meter
D	615 166 041 0	ELRT25T-4Q-5	Hex. 1/4	Quick change chuck	10	25	7.4	18.4	4600	249	9.8	2.6	5.7	5 meters
D	615 166 048 0	ELRT25T-4Q-1	Hex. 1/4	Quick change chuck	10	25	7.4	18.4	4600	249	9.8	2.1	4.6	1 meter
E	615 166 022 0	ELRT050-P4900-10S	Sq. 3/8	Trough hole	20	50	14.8	36.9	4900	244	9.6	1.7	3.7	N/A
F	615 166 042 0	ELRT050T-10S-5	Sq. 3/8	Trough hole	20	50	14.8	36.9	4900	271	10.7	3.0	6.6	5 meters
F	615 166 049 0	ELRT050T-10S-1	Sq. 3/8	Trough hole	20	50	14.8	36.9	4900	271	10.7	2.5	5.5	1 meter

Electric nutrunners - ERP

0.5 to 40 Nm (0.11 to 9 ft.lb) - 2000 rpm



A



B

PIC REF	MODEL	PART NUMBER	OUTPUT DRIVE	TORQUE						ROTATIONAL SPEED	LENGTH		WEIGHT	
				MIN.	RECOM MENDED	MAX	MIN.	RECOM MENDED	MAX		mm	in.	kg	lb
			in.	Nm	Nm	Nm	ft.lb	ft.lb	ft.lb	rpm				
A	ERP5	615 166 198 0	Hex. 1/4 F	0.5	5	5	0.11	1.12	1.12	2000	222	8.7	1.1	2.4
A	ERP20	615 166 199 0	Hex. 1/4 F	3	20	20	0.67	4.5	4.5	1540	232	9.1	1.2	2.6
A	ERP30	615 166 200 0	Sq. 3/8	5	30	30	1.12	6.7	6.7	1070	228	9.0	1.2	2.6
A	ERP40	615 166 201 0	Sq. 3/8	6	40	40	1.35	9	9	680	263	10.4	2.1	4.6
B	ERP5TC	615 166 202 0	Hex. 1/4 F	0.5	5	5	0.11	1.12	1.12	2000	248	9.8	2.5	5.5
B	ERP20TC	615 166 203 0	Hex. 1/4 F	3	20	20	0.67	4.5	4.5	1540	258	10.2	2.6	5.7



ACCESSORIES
see page 98

MultiCVIL II - Main Features

MULTICHANNELSYSTEM

Drive up to 32 fixtured spindles
One CVIL Master + x times CVIL Slave

Through CVIPC2000 (to Master only)

Cycles Phases management

- 31 different cycles
- Combines up to 20 phases in a fastening cycle

Data collection

- CVIPC2000
- CVINET WEB

Fieldbuses

- By additional modules
- By Ethernet ports
- Flexible mapping

Isagraf, embedded PLC software to manage:

- Assembly station
- HMI

FIXTUREDSPINDLES

- From 1 to 1900Nm
- EME straight
- EMEOF with Offset for close center distance application
- EMEL "L" shape reduces the height of the tool
- High accuracy
- A10 class
- Digital communication between the tool and controller
- Memory chip with all characteristics of the tool: transducer sensitivity, gear ratio, maintenance info, etc...

ONECABLE

- Motor power
- Digital connection of the transducer and memory device
- Up to 45 meters
- Design to be used in robot applications



Flexibility of tightening process

EASY PROGRAMMING OF THE TIGHTENING SEQUENCE WITH FULL SYNCHRONIZATION

Run Down phase

Spindle 1-2-3-4-5-6-7-8-9-10

Final Speed phase

Spindle 1-2

Final Speed phase

Spindle 3-4-5-6

Final Speed phase

Spindle 7-8-9-10

Automatic Repair Action

Reverse all spindles and retry once
Jump to phase 2

End of the cycle

Reporting



CVIPC



MAIN FUNCTIONS	MULTICVIL II
Number of channels	1 to 32
Number of cycles	31
Number of phases	20
Batch count	999
Bar code reading via RS232 port	
Tightening results	
Torque + Angle + Date + Time + Report	up to 32 000
Number of curves (per channel)	10
Tightening strategies	
Torque control + angle monitoring	✓
Angle control + torque monitoring	✓
T control + (Angle + torque rate) monitoring	✓
Angle control + (Torque + torque rate) monitoring	✓
Yield point strategy	✓
Stall torque	✓
Prevailing torque	✓
Current monitoring	✓
Reverse at Angle control	✓
Tightening connectivity	
Input/Output	8/8
RS232 port	OK
Ethernet RJ45	8 sockets
Fieldbuses	Optional module
Embedded PLC software	OK
IP54	Optional module
Emergency stop	2 channels

Controllers - MultiCVIL II



MODEL	PART NUMBER	CONSUMPTION (CURRENT)		MAINS SUPPLY	DIMENSIONS						WEIGHT	
		115 V	230 V		WIDTH		HEIGHT		DEPTH		kg	lb.
CVIL II M (Master)	615 932 682 0	4A	2A	Single phase	130	5.1	278	10.9	291	11.5	5.9	13
CVIL II S (Slave)	615 932 683 0	4A	2A	Single phase	130	5.1	278	10.9	291	11.5	5.9	13
Kit Combox V2 Multi CVIL2	615 929 050 0											

OPTIONAL ACCESSORIES



	PART NO.
• Kit IP54 CVILII	615 932 684 5

Fieldbus module

MODEL	PART NO.
• Ethernet IP Module	615 927 594 0
• Profi bus DP Module	615 927 595 0
• ProfiNet Module (1 port)	615 927 596 0
• ProfiNet Module (2 ports)	615 927 597 0
• Devicenet Module	615 927 599 0
• MODBUS TCP Slave	615 927 615 0
• Shelf support - Aluminium profile	615 397 403 5

Kit version



One CVIL-Master



n.CVIL-Slaves



Software CVIPC 2000 + Power cord



Multicombox

Contact your Desoutter representative for assistance



Also available: Specially designed a frame to secure controllers and ensure safe and tidy wiring

Turn Key Solution



One CVIL-Master



n.CVIL-Slaves



Software CVIPC 2000 + Network cables & Power cord



One power box supply with E Stop - Ethernet switches
Multicombox - Circuit breakers

Powerbox depending on power supply



Fixtured electric spindles

High durability of EME tools

- Long life gear boxes
- Brushless motor
- High output torque transducer for a larger torque range

MODEL	PART NUMBER	SQUARE DRIVE	TORQUE RANGE		ROTATIONAL SPEED	MIN. CENTRE DISTANCE		LENGTH		WEIGHT	
			in.	Nm		ft.lb	rpm	mm	in.	mm	in.
EME35-10J	615 165 423 0	3/8	1-8	0.7-5.9	2067	43.2	1.7	283	11.1	1.7	3.7
EME35-20J	615 165 424 0	3/8	4-15	2.1-11	2067	43.2	1.7	308	12.1	2.0	4.4
EME38-10J	615 165 425 0	3/8	9-30	6.6-22	1287	43.2	1.7	355	14	2.0	4.4
EME38-20J	615 165 426 0	3/8	10-45	7.4-33	1092	43.2	1.7	355	14	2.0	4.4
EME51-10J	615 165 427 0	1/2	20-70	15-52	650	51.2	2.0	374	14.7	2.9	6.4
EME51-20J	615 165 428 0	1/2	30-135	22-99	403	51.2	2.0	401	15.8	3.5	7.7
EME60-10J	615 165 429 0	1/2	20-95	15-70	923	60.2	2.4	431	16.9	4.8	10.6
EME60-20J	615 165 430 0	3/4	50-175	37-129	507	60.2	2.4	431	16.9	4.8	10.6
EME60-30J	615 165 431 0	3/4	70-250	52-184	299	60.2	2.4	467	18.4	5.2	11.5



EMEL shape for close access

MODEL	PART NUMBER	SQUARE DRIVE	TORQUE RANGE		ROTATIONAL SPEED	MIN. CENTRE DISTANCE		LENGTH		WEIGHT	
			in.	Nm		ft.lb	rpm	mm	in.	mm	in.
EMEL38-20J	615 165 517 0	3/8	10-45	7.4-33.2	1092	43.2	1.7	140.5	5.5	3.0	6.6
EMEL51-20J	615 165 518 0	1/2	30-135	22-99.5	403	51.2	2.0	166	6.5	4.0	8.8
EMEL60-20J	615 165 519 0	3/4	50-175	37-129	481	60.2	2.4	178	7	6.0	13.2
EMEL60-30J	615 165 520 0	3/4	70-250	52-184	312	60.2	2.4	178	7	6.0	13.2



EME Offset with torque transducer in line with the output shaft

Increase access by using smallest CC distances offered

MODEL	PART NUMBER	SQUARE DRIVE	TORQUE RANGE		ROTATIONAL SPEED	MIN. CENTRE DISTANCE		LENGTH		WEIGHT	
			in.	Nm		ft.lb	rpm	mm	in.	mm	in.
EME24-20 OF	615 165 512 0	3/8	4-20	2.9-15	1225	24	0.95	375.2	14.8	2.7	5.9
EME26-50 OF	615 165 513 0	3/8	7-50	5.2-40	985	26	1.02	387.5	15.2	2.7	5.9
EME30-80 OF	615 165 514 0	1/2	10-80	7.4-59	580	30	1.18	414.3	16.3	3.9	8.6
EME36-140 OF	615 165 515 0	1/2	19-140	14-103	375	36	1.42	454.4	17.7	4.7	10.4
EME40-180 OF	615 165 516 0	3/4	25-180	18-133	475	40	1.57	481.7	18.9	6.4	14.1



Fixtured electric spindles ERF

For your assembly applications, Desoutter offers a range of fixtured electric spindles, transducerized or current controlled with integrated cable

MODEL	PART NUMBER	TORQUE RANGE	
		Nm	ft.lb
ERF3L	615 165 286 0	0.35 - 3	0.26 - 2.2
ERF5L	615 165 287 0	0.5 - 5	0.37 - 3.7
ERF10L	615 165 288 0	3 - 10	2.2 - 7.4
ERF20L	615 165 289 0	5 - 20	3.7 - 14.8
ERF20S	615 165 290 0	5 - 20	3.7 - 14.8
ERF30S	615 165 291 0	7 - 30	5.2 - 22.1

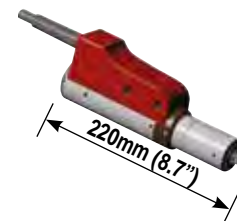

For further information about the technical data see pages 61 and 73



ACCESSORIES
see page 99

Accessories



ERP

ACCESSORIES INCLUDED

ITEM		PART NO. ERP
1	Side handle	467033
2	Suspension bail	467003

OPTIONAL ACCESSORIES

ITEM		PART NO. ERP
3	High resistance side handle ERP	615 397 012 0
Plastic cover		
4	Plastic cover ERP.S	615 573 074 0
4	Plastic cover ERP.L	615 573 075 0
4	Plastic cover ERP.LT	615 573 076 0
Desoutter Tool Holster		
5	DTH90	615 812 119 0

CABLE FOR ERP TOOLS	PART NO.
Nutrunner cable 5m (16ft)	615 917 492 0
Nutrunner cable 10m (32ft)	615 917 494 0
Nutrunner cable 15m (49.2ft)	615 917 495 0

HEAVY DUTY EXTENTION CABLE FOR ERP TOOLS	PART NO.
Ext. cable 5m (16ft)	615 917 083 0
Ext. cable 10m (32ft)	615 917 084 0
Ext. cable 15m (49.2ft)	615 917 085 0
Ext. cable 20m (65.6ft)	615 917 086 0
Ext. cable 25m (82ft)	615 917 087 0
Ext. cable 30m (98ft)	615 917 088 0

HEAVY DUTY CABLE FOR ERP TOOLS	PART NO.
Cable 2.5m (8.2ft)	615 917 570 0
Cable 5m (16ft)	615 917 571 0
Cable 10m (32ft)	615 917 572 0



SOCKET TRAY

- Socket tray (sockets not included) **615 936 005 0**
- 37 pin D-Sub female I/O adapter **615 919 003 0**

CABLE LENGTH:	1m (3.3ft)	5m (16ft)	10m (32.8ft)	15m (49.2ft)
• Cable for sockets tray for CVIxlI	615 917 265 0	615 917 266 0	615 917 267 0	615 917 268 0



Accessories



ERS / ERSA / ERSF / E-LRT

OPTIONAL ACCESSORIES

ITEM		ERS.	ELRT
1	Long lever Kit	615 321 254 0	
2	Suspension yoke kit	615 791 080 0	
3	Reaction handle	615 397 016 0	
4	Plastic cover for ELRT		615 211 012 0
5	Pistol grip kit for ERS	615 390 059 0	
6	D53-25 Linear arm (tool clamp included) - (see page 148)	615 810 702 0	
6	D53-25X Linear arm, extended reach (tool clamp included) - (see page 148)	615 810 703 0	
7	D53-25S Folder arm (tool clamp included) - (see page 148)	615 810 708 0	
	• Torque tubes	see page 169	
8	Bit Tray	615 929 025 0	615 929 025 0
9	Spring suspension balancer	50522	50542
10	Tool Holster DTH90		615 812 119 0
11	ERS Module	615 936 537 0	
12	Sleeve drive socket	see page 297/298/299	

EXTENTION CABLE FOR ERS TOOLS	PART NO.
Ext. cable 5m (16ft)	615 917 222 0
Ext. cable 10m (32ft)	615 917 224 0

HEAVY DUTY THIN CABLE FOR ELRT TOOLS	PART NO.
Cable 5m (16ft)	615 917 641 0

HEAVY DUTY EXTENTION CABLE FOR ELRT TOOLS	PART NO.
Ext. cable 5m (16ft)	615 917 083 0
Ext. cable 10m (32ft)	615 917 084 0
Ext. cable 15m (49.2ft)	615 917 085 0
Ext. cable 20m (65.6ft)	615 917 086 0
Ext. cable 25m (82ft)	615 917 087 0
Ext. cable 30m (98ft)	615 917 088 0



EME / EMEL

OPTIONAL ACCESSORIES



TRANSDUCER-HOLDER FOR EME TOOL	PART NO.
• 3/8" square drive EME35/EME38	615 396 426 0
• 1/2" square drive EME51/EME60.10	615 396 427 0
• 3/4" square drive EME60.20/EME60.30	615 396 428 0
• 3/4" square drive EME80.10/EME80.20	615 396 429 0

EME ADAPTATION ON EXISTING APPLICATION (SEPARATED CABLE TORQUE + MOTOR CABLE)	PART NO
• EME adaptation on old cable	615 917 539 0



CABLE FOR EME TOOLS - MULTICVIL & CVIL II	PART NO.
Cable 5m (16ft)	615 917 541 0
Cable 10m (32ft)	615 917 542 0
Cable 15m (49.2ft)	615 917 543 0

EXTENTION CABLE FOR EME TOOLS - MULTICVIL & CVIL II	PART NO.
Ext. cable 5m (16ft)	615 917 083 0
Ext. cable 10m (32ft)	615 917 084 0
Ext. cable 15m (49.2ft)	615 917 085 0
Ext. cable 20m (65.6ft)	615 917 086 0
Ext. cable 25m (82ft)	615 917 087 0
Ext. cable 30m (98ft)	615 917 088 0



CVIC Range Current controlled



Easy to integrate

Small size and smooth design for a simple installation.

Speed up the set up time by using the self learning process. Provides automatic set up for the tool to optimize your fastening process.



Multi torque capability

Replace multiple pneumatic tools with one electric tool per station.



Fastening quality guaranteed in all your products

Set up a batch count to ensure all bots are tightened with correct strategy.



Quality of tightening

Control torque and angle with multi phases strategies.

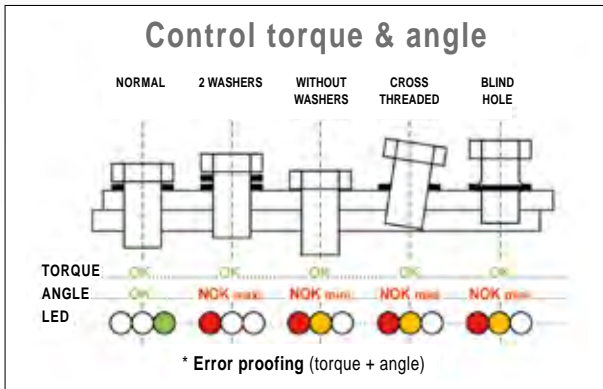

Advanced ergonomics

Maximize your operators' comfort with ergo stop and direct reporting led in the controller and on the tool.



Open to peripherals

Increase your assembly quality and process through barcode reader, socket tray or bit tray. Control tightening order with our positioning system.

Technical features

CVIC Range

MAIN FUNCTIONS	NORMAL		ECP HIGH TORQUE	
	L STANDARD	H ADVANCED	L STANDARD	H ADVANCED
Quick cycle with self-learning of the joint	✓	✓		
Number of cycles in the controller	1	15	1	15
Number of phases	15	15	15	15
Batch count (999 OK reports)	✓	✓	✓	✓

TIGHTENING RESULTS	
Torque + Angle + Date + Time + Report	5000 to 20000 according configuration

TYPES OF PHASES IN A CYCLE				
Search Sequence	✓	✓		
Run Down speed	✓	✓	✓	✓
Final speed	✓	✓	✓	✓
Run reverse	✓	✓		
Action on NOK	✓	✓		
Prevailing torque monitoring	✓	✓		

FINAL SPEED STRATEGIES				
Torque control + Angle monitoring	✓	✓	✓	✓
Angle control + Torque monitoring	✓	✓	✓	✓

DISPLAY AND PROGRAMMING				
Display				
LCD display	✓	✓	✓	✓
Keyboard				
8 button keypad	✓	✓	✓	✓
Reports				
LEDs	6	6	6	6
PC Software Windows				
program cycles, collect, display and save results, run statistics, curves				
CVIPC2000 *: Connection 'point to point' (RS232)	✓	✓	✓	✓
Connection through ethernet	✓	✓	✓	✓

*All CVIPC2000 versions are compatible with CVICs

MAINTENANCE				
Access to all tool parameters (tool memory)	✓	✓	✓	✓
Autotest of the complete system	✓	✓	✓	✓
Spindle rotation test	✓	✓	✓	✓
Input/Output selection	✓	✓	✓	✓
Date of the last maintenance operation	✓	✓	✓	✓
Total and partial cycle counters	✓	✓	✓	✓

PERIPHERALS				
Input/Output	8/8	8/8	8/8	8/8
Serial port RS232 (PC transfer, Bar code, Report output)	✓	✓	✓	✓
Ethernet connection (CVIPC2000 / CVInet)	✓	✓	✓	✓

MODEL				
CONTROLLER for low torque tools	CVIC II L-2	CVIC II H-2		
CONTROLLER for the other tools	CVIC II L-4	CVIC II H-4	CVIC II L-4	CVIC II H-4

MAINS SUPPLY				
Single-phase, automatic switching 110V/230V	✓	✓	✓	✓

Controllers - CVIC

Electric current control

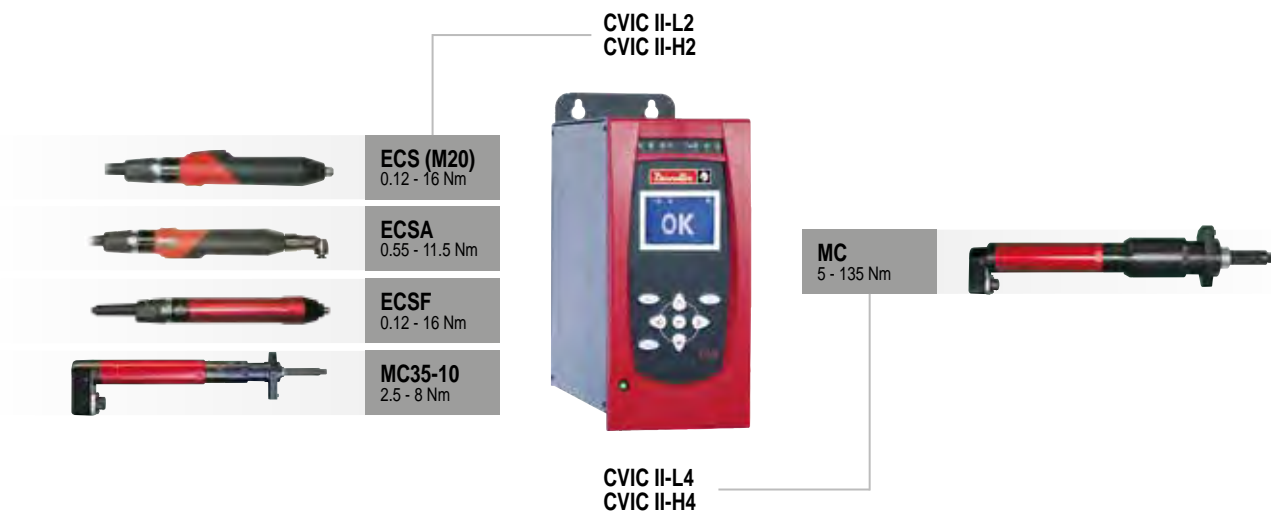

MODEL	PART NUMBER	TOOLS	CONSUMPTION (current)		MAINS SUPPLY	DIMENSIONS			WEIGHT				
			115V	230V		50/60 hertz	WIDTH	HEIGHT	DEPTH	kg	lb.		
CVIC II CONTROLLERS													
CVIC II-L2	615 932 676 0	ECS / ECPL(T) / ECD5 / MC35-10 / ECA15	4A	2A	Single-phase	130	5.1	278	10.9	291	11.5	5	11
CVIC II-H2	615 932 677 0	ECS / ECPL(T) / ECD5 / MC35-10 / ECA15	4A	2A	100 to 250 V	130	5.1	278	10.9	291	11.5	5	11
CVIC II-L4	615 932 678 0	Other tools	8A	4A	Single-phase	130	5.1	278	10.9	291	11.5	5	11
CVIC II-H4	615 932 679 0	Other tools	8A	4A	100 to 250 V	130	5.1	278	10.9	291	11.5	5	11

START-UP KIT to be ordered with the controller
Including: **Power cable and plug**

PLUG	DESCRIPTION	PART NO.
A	European	615 917 201 0
B	US	615 917 203 0
C	UK	615 917 202 0
D	Chinese	615 917 206 0



OPTIONAL ACCESSORIES

	PART NO.
• PC cable Length 2m (78.7")	615 917 047 0
• Printer cable Length 2m (78.7")	615 917 011 0
• 37 pin D-Sub female I/O adapterR	615 919 003 0
• BRDx2 (Backup Rescue Device)	615 936 328 0

Fieldbus / Protocol

MODEL	PART NO.
Ethernet IP Module	615 927 594 0
Profibus DP Module	615 927 595 0
ProfiNet Module (1 port)	615 927 596 0
ProfiNet Module (2 ports)	615 927 597 0
CC-Link Module	615 927 598 0
Devicenet Module	615 927 599 0
MODBUS TCP Slave	615 927 615 0

Torque range

Performances of Portable electric nutrunners

ECS, ECSA Series

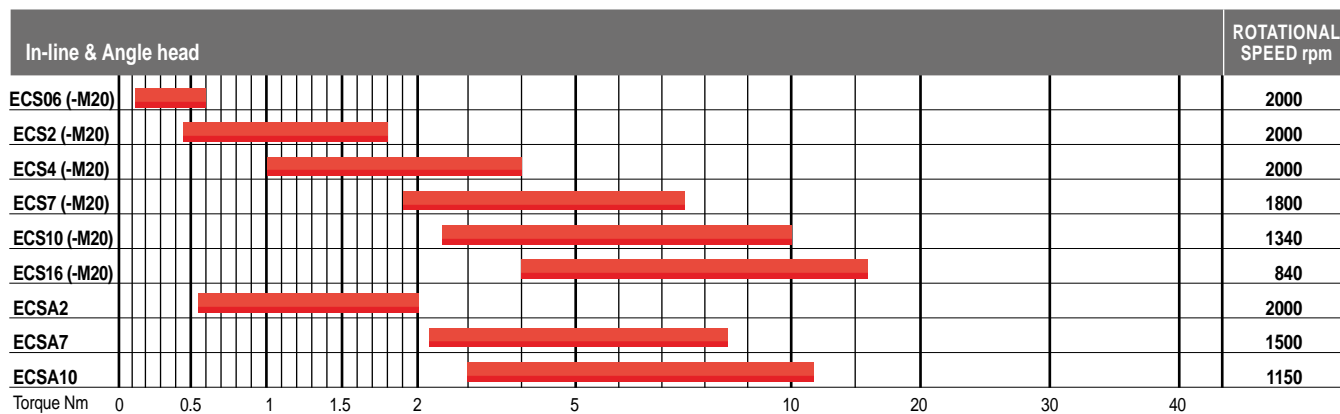

Performances of Fixtured electric spindles

ECSF and MC Series

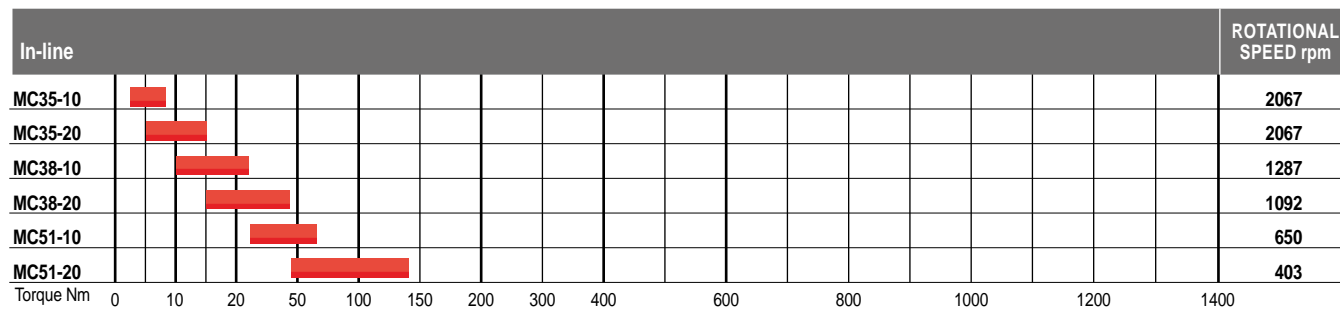
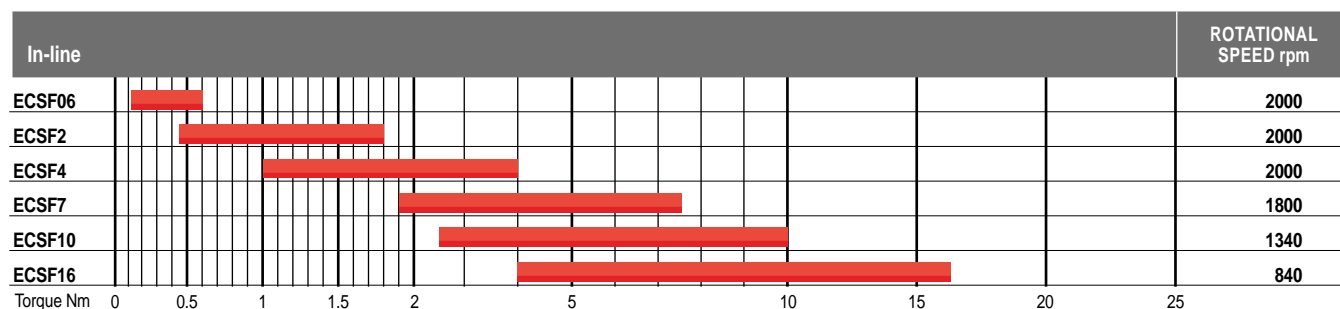

Electric screwdrivers - CVIC

0.12 to 16 Nm (1.1 to 141.6 in.lb) - 840 to 2000 rpm

The ECS series offers outstanding torque accuracy and operator ergonomics, making it the ideal choice for assembly operations that require a high level of quality



Improve your joint visibility



Adapt your tool with accessories



Get the best tightening feedback directly on the tool



A



B



C



ACCESSORIES
see pages 110-111

PIC REF	MODEL	PART NUMBER	OUTPUT HEX	TORQUE RANGE				ROTATIONAL SPEED	LENGTH		WEIGHT	
				MIN. Nm	MAX. Nm	MIN. in.lb	MAX. in.lb		mm	in.	kg	lb.

ELECTRIC SCREWDRIVERS - IN-LINE

A	ECS06	615 165 442 0	Hex. 1/4 F	0.12	0.6	1.1	5.3	2000	285	11.2	0.6	1.3
A	ECS2	615 165 443 0	Hex. 1/4 F	0.45	1.8	4	15.9	2000	285	11.2	0.6	1.3
A	ECS4	615 165 445 0	Hex. 1/4 F	1	4	8.8	35.4	2000	285	11.2	0.6	1.3
A	ECS7	615 165 446 0	Hex. 1/4 F	1.9	7.5	16.8	66.4	1800	285	11.2	0.7	1.5
A	ECS10	615 165 444 0	Hex. 1/4 F	2.5	10	22.1	88.5	1340	285	11.2	0.7	1.5
A	ECS16	615 165 459 0	Hex. 1/4 F	4	16	35.4	141.6	840	285	11.2	0.7	1.5
B	ECS06-M20	615 165 454 0	Hex. 1/4 F	0.12	0.6	1.1	5.3	2000	285	11.2	0.6	1.3
B	ECS2-M20	615 165 455 0	Hex. 1/4 F	0.45	1.8	4	15.9	2000	285	11.2	0.6	1.3
B	ECS4-M20	615 165 456 0	Hex. 1/4 F	1	4	8.8	35.4	2000	285	11.2	0.6	1.3
B	ECS7-M20	615 165 457 0	Hex. 1/4 F	1.9	7.5	16.8	66.4	1800	285	11.2	0.7	1.5
B	ECS10-M20	615 165 458 0	Hex. 1/4 F	2.5	10	22.1	88.5	1340	285	11.2	0.7	1.5
B	ECS16-M20	615 165 460 0	Hex. 1/4 F	4	16	35.4	141.6	840	285	11.2	0.7	1.5

ELECTRIC SCREWDRIVERS - ANGLE HEAD

C	ECSA2	615 165 447 0	Hex. 1/4 F	0.55	2.2	4.9	19.5	2000	329	12.9	1	2.2
C	ECSA7	615 165 448 0	Hex. 1/4 F	2.2	8.5	19.5	75.2	1500	329	12.9	1	2.2
C	ECSA10	615 165 449 0	Hex. 1/4 F	3	11.5	26.6	101.8	1150	329	12.9	1	2.2

Fixtured electric spindles - CVIC

0.12 to 16 Nm (1.1 to 141.6 in.lb) - 840 to 2000 rpm



A



Offset head for application with close centers (minimum 19mm)



Automatically adjust the stroke for multispindle applications with spring loaded shafts



Mount your spindle easily on a support using the adapted flange

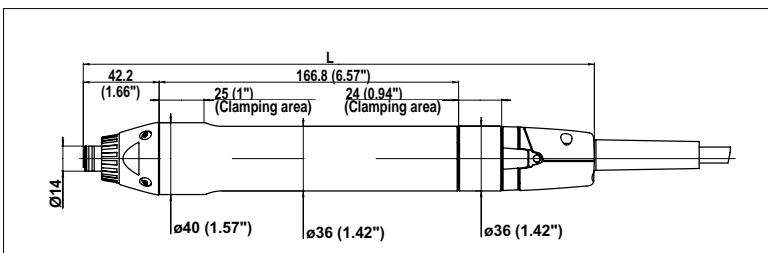

ACCESSORIES
see page 110-111

PIC REF	MODEL	PART NUMBER	OUTPUT HEX	TORQUE RANGE		ROTATIONAL SPEED AT	LENGTH		WEIGHT	
				in.	Nm		in.lb	rpm	mm	in.
A	ECSF06	615 165 501 0	Hex. 1/4 F	0.12-0.6	1.1-5.3	2000	285	11.2	0.6	1.3
A	ECSF2	615 165 502 0	Hex. 1/4 F	0.45-1.8	4.0-15.9	2000	285	11.2	0.6	1.3
A	ECSF4	615 165 503 0	Hex. 1/4 F	1.0-4.0	8.8-35.4	2000	285	11.2	0.6	1.3
A	ECSF7	615 165 504 0	Hex. 1/4 F	1.9-7.5	16.8-66.4	1800	285	11.2	0.7	1.5
A	ECSF10	615 165 505 0	Hex. 1/4 F	2.5-10	22.1-88.5	1340	285	11.2	0.7	1.5
A	ECSF16	615 165 506 0	Hex. 1/4 F	4.0-16	35.4-141.6	840	285	11.2	0.7	1.5
A	*ECSF06-03	615 166 071 0	Hex. 1/4 F	0.12-0.6	1.1-5.3	2000	285	11.2	0.6	1.3
A	*ECSF2-03	615 166 072 0	Hex. 1/4 F	0.45-1.8	4.0-15.9	2000	285	11.2	0.6	1.3
A	*ECSF4-03	615 166 073 0	Hex. 1/4 F	1.0-4.0	8.8-35.4	2000	285	11.2	0.6	1.3
A	*ECSF7-03	615 166 074 0	Hex. 1/4 F	1.9-7.5	16.8-66.4	1800	285	11.2	0.7	1.5
A	*ECSF10-03	615 166 075 0	Hex. 1/4 F	2.5-10	22.1-88.5	1340	285	11.2	0.7	1.5
A	*ECSF16-03	615 166 076 0	Hex. 1/4 F	4.0-16	35.4-141.6	840	285	11.2	0.7	1.5

*Models with 30cm integrated cable instead of 4 meters

Fixtured electric spindles - CVIC

2.5 to 135 Nm (1.8 to 99 ft.lb) - 403 to 2067 rpm



A



B



ACCESSORIES
see page 110-111

PIC REF	MODEL	PART NUMBER	SQUARE DRIVE	TORQUE RANGE		ROTATIONAL SPEED AT		TELESCOPIC		MIN CENTRE DISTANCE		LENGTH		WEIGHT	
				in.	Nm	ft.lb	rpm/230 V	rpm/110 V	mm	in.	mm	in.	mm	in.	kg
A	MC35-10	615 165 107 0	3/8	2.5-8	1.8-5.9	2067	2067	50	1.97	43.2	1.7	276	10.9	1.7	3.7
A	MC35-20	615 165 108 0	3/8	5-15	3.7-11	2067	2067	50	1.97	43.2	1.7	301	11.8	2.0	4.4
A	MC38-10	615 165 109 0	3/8	10-30	7.4-22	1287	1287	50	1.97	43.2	1.7	347	13.7	2.0	4.4
A	MC38-20	615 165 110 0	3/8	15-45	11-33	1092	1092	50	1.97	43.2	1.7	347	13.7	2.0	4.4
B	MC51-10	615 165 111 0	1/2	25-70	18-52	650	650	50	1.97	51.2	2.0	366	14.4	2.9	6.4
B	MC51-20	615 165 112 0	1/2	45-135	33-99	403	403	50	1.97	51.2	2.0	393	15.4	3.5	7.7

For MC.tools with Offset heads, please contact your local Desoutter sales engineer for more information

Posco 500 Positioning system

Flexibility and control

Used in conjunction with encoders equipped arms stand or carbon arm, the system ensures that the tool is positioned at the right screw during the operation. An output signal will confirm to your PLC that the job is done.

Easy programming

The Posco 500 system lets you program a sequence of operations by "self learning mode" and ensures that the steps are completed in the right order and in the right conditions.

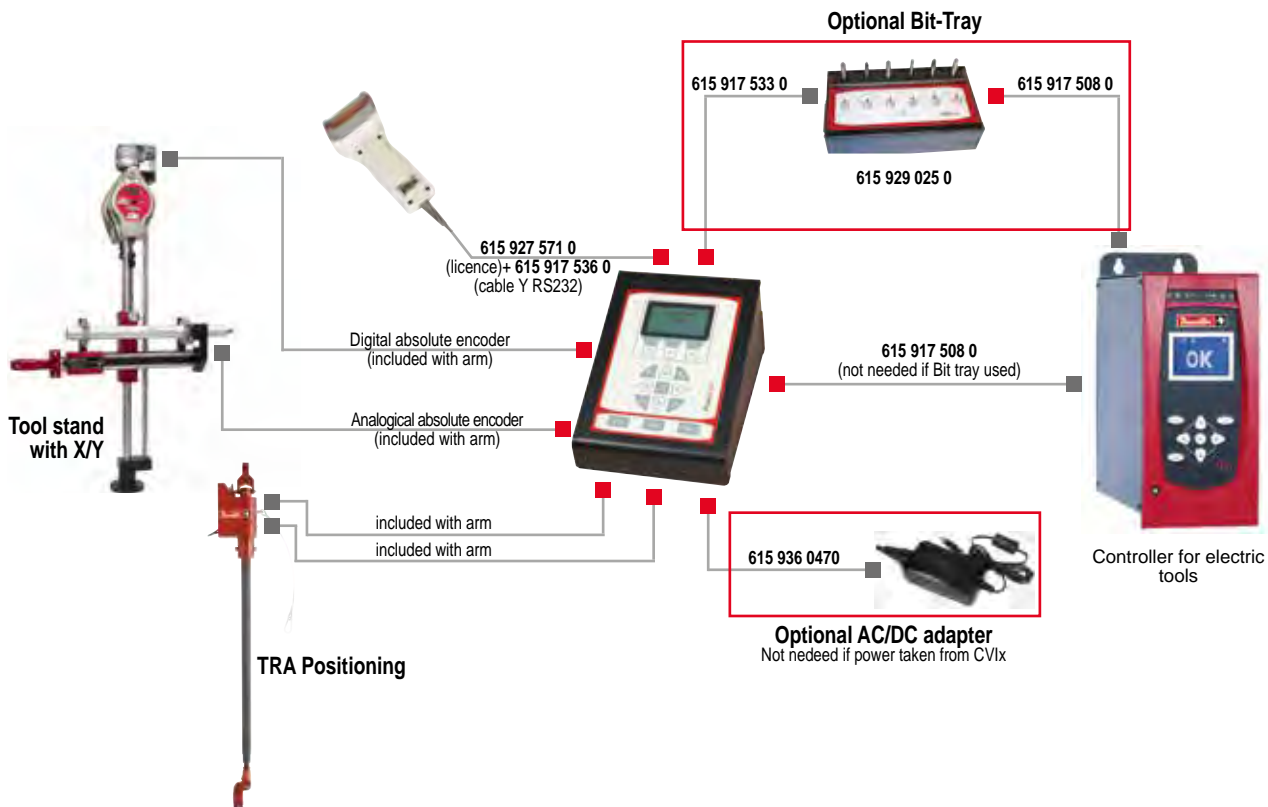

POSCO 500 BOX	PART NO.
Posco 500 controller desk	615 932 656 0
Posco 500 controller desk with I/O extension	615 932 658 0
Posco500 controller wall with I/O extension	615 932 659 0
AC/DC adapter 90-260V/24V 30W	615 936 047 0
I/O add-on board	615 929 026 0
OTHERS	PART NO.
Bit tray module	615 929 025 0
Mounted set	615 930 777 0

CABLE	PART NO.
Cable Posco 500 / I-O CVI	615 917 508 0
Cable Posco 500 / CVIXS	615 917 747 0
Cable Posco 500 / Bit-Tray	615 917 533 0
Cable Y RS232	615 917 536 0
Cable Posco 500 / Bit-Tray / CVIxl	615 917 508 0
I/O Adapter for CVIx II controllers	615 919 003 0
SOFTWARES & LICENCES	PART NO.
Barcode license	615 927 571 0
Advanced Programming Licence	615 927 572 0
PC Connection licence 1 User	615 927 573 0
PC Connection licence 5 Users	615 927 574 0
PC Connection licence 10 Users	615 927 575 0
FAS support licence	615 936 048 0

How to order?

Controller & Tool CVI3 or CVI2 + **Positioning Arm D53 X/Y or TRA X/Y** + **POSCO 500**
615 932 656 0
or
615 932 658 0
or
615 932 659 0

OPTIONS

AC / DC Adapter 615 936 047 0 + **Accessories**



Accessories

ECS

ACCESSORIES INCLUDED

ITEM		PART NO.
1	Fixed suspension bail for ECS	205 049 537 3

OPTIONAL ACCESSORIES

ITEM		PART NO.
------	--	----------

ECS / ECSA

2	Reaction handle for ECS	615 397 016 0
3	Stationary suspension bail for ECSA	615 791 080 0
	• Tool clamp for ECS	615 396 616 0
4	Pistol grip kit for ECS	615 390 059 0

Spring Loaded Shafts and Bearings Support for ECS-M20/ECSF

5	Bit Adaptor	103782
6	Spring Loaded Shaft 25mm (1") stroke, 3/8" Sq Drive	108342
7	Shaft Support and Nose Mount	108412

Nose Mounts for ECS-M20/ECSF

8	Nose Mount	205 052 876 3
9	Flange	205 052 875 3

Offset Head and Spring Loaded Shaft for ECS-M20/ECSF

6	Spring loaded shaft 25mm (1") stroke, 3/8" square drive	108342
10	Offset Head, Offset 30mm (1.18")	384993

Screwdriver Bit Adaptor for ECS/ECSA/ECS-M20/ECSF

11	3/8" Square to 1/4" HexPower Adaptor	108322
----	--------------------------------------	--------



Accessories



ECS

SOCKETS TRAY & BITS TRAY	PART NO.
• Socket tray (sockets not supplied)	615 936 005 0
• Bit tray (bits not included)	615 929 025 0

CABLE FOR SOCKET TRAY	PART NO.
Cable 1m (3.3ft)	615 917 265 0
Cable 5m (16ft)	615 917 266 0
Cable 10m (32.8ft)	615 917 267 0
Cable 15m (49.2ft)	615 917 268 0

CABLE FOR BIT TRAY	PART NO.
Extension cable 2m (6.4ft)	615 917 535 0

EXTENSION CABLE FOR ECS TOOLS	PART NO.
Extension cable 5m (16ft)	615 917 222 0
Extension cable 10m (32.8ft)	615 917 224 0

MC

OPTIONAL ACCESSORIES

	PART NO.
• Motor/In-line connector assembly kit for MC35-10 to MC51-20	615 396 198 0

Transducer-holder from MC tool

• 3/8" square drive MC35/MC38	615 396 426 0
• 1/2" square drive MC51-10	615 396 427 0

CABLE FOR MC TOOLS	PART NO.
Tool cable 5m (16ft)	615 917 232 0
Tool cable 10m (32.8ft)	615 917 234 0
Tool cable 15m (49.2ft)	615 917 235 0

EXTENSION CABLE FOR MC TOOLS	PART NO.
Tol extension cable 5m (16ft)	615 917 222 0
Tool estension cable 10m (32.8ft)	615 917 224 0





SLBN screwdrivers controllers

Advanced controller for SLBN screwdrivers

Flexible speed

- Speed adjustment

Protection of the parameters

- Setting locked by key

Universal

- Compatible with all the SLBN range



Fastening Strategies

- PreRun reverse
- Slow start
- Final fastening
- Post run reverse



Batch counting

- Incremental or decremental counting up to 99



INPUTS AND OUTPUTS FOR PLC COMMUNICATION

- Inputs :**
- Remote Start
 - Remote Reverse
 - Enable tool A
 - Enable tool B
 - Enable Reverse
 - Reset Batch
 - NOK Acknowledgment
 - Psets 1 to 5
 - PreRun Reverse enable

- Outputs :**
- OK
 - NOK
 - OK Batch
 - Tool running forward
 - Tool running reverse
 - 24/12 Vdc

START-UP KIT to be ordered with the controller

Including : Power cable and plug

PLUG	DESCRIPTION	PART NO.
A	European	615 917 201 0
B	US	615 917 203 0
C	UK	615 917 202 0
D	Chinese	615 917 206 0

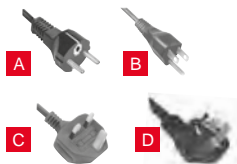

PIC REF	MODEL	PART NUMBER	DIMENSIONS			WEIGHT		VOLTAGE VAC	COMPATIBLE TOOLS			
			WIDTH	HEIGHT	DEPTH	kg	lb.					
A	ESP1	615 932 635 0	mm	in	mm	in	mm	in	kg	lb.	100-240	SLBN003/010/012/020
B	ESP1-HT	615 932 637 0	213	8.4	131	5.20	65	2.60	1.80	3.9	100-240	SLBN030/050
B	ESP1-HT PLUS	615 932 707 0	213	8.4	131	5.20	65	2.60	1.63	3.6	100-240	SLBN90/120
C	ESP2-A	615 932 708 0	135	5.3	285	11.2	105	4.1	2.8	4.4	100-240	SLBN003-SLBN120

Low Voltage Screwdriver with clutch shut off - SLBN



Flexibility

- Installation by clamping in the top or in the front by a torque fixing ring

ESD Certification

- Dedicated version for Electrostatic discharge component protection



Productivity

- Speed up to 2000 rpm
- Maintenance free thanks to brushless motor

Ergonomy

- Soft Rubber grip
- Low noise level < 70dB (A)

Standard Version - SLBN

0.02 to 12 Nm (0.18 to 106.2 in.lb) - 160 to 2000 rpm



A



B



C



D



E



F

MODEL	LENGHT		WEIGHT	
	mm	in.	kg	lb.
SLBN001	174	6.8	0.17	0.37
SLBN003/010	182	7.2	0.38	0.34
SLBN012/020	245	9.6	0.58	1.28
SLBN030/050	283	11.1	0.80	1.76
SLBN090/120	301	11.8	1.25	2.76



ACCESSORIES
see page 119

PIC REF	MODEL	PART NUMBER	OUTPUT HEX	FREE SPEED		TORQUE RANGE		TORQUE RECOMMENDED		VOLTAGE VDC	CONTROLLER
				in	Hi rpm	Lo rpm	Nm	in.lb	Nm		

LEVER START - LOW VOLTAGE - CLUTCH CONTROL - SHUT OFF

A	SLBN001-L1000-SWS	615 165 873 0	whing shank	1000	700	0.02-0.14	0.18-1.32	0.10	0.91	15	ESP1.LT included
A	SLBN003-L230-S4Q	615 165 922 0	1/4	230	160	0.07-0.34	0.62-2.99	0.24	2.09	25	ESP1
A	SLBN003-L1000-S4Q	615 165 923 0	1/4	1000	750	0.07-0.34	0.62-2.99	0.24	2.09	25	ESP1
A	SLBN010-L1000-S4Q	615 165 955 0	1/4	1000	750	0.1-1	0.88-8.8	0.70	6.16	25	ESP1
B	SLBN012-L1000-S4Q	615 165 924 0	1/4	1000	750	0.2-1.18	1.76-10.4	0.83	7.28	32	ESP1
B	SLBN012-L2000-S4Q	615 165 925 0	1/4	2000	1500	0.2-1.18	1.76-10.4	0.83	7.28	32	ESP1
B	SLBN020-L1000-S4Q	615 165 926 0	1/4	1000	750	0.29-1.9	2.57-16.8	1.33	11.76	32	ESP1
C	SLBN030-L1000-S4Q	615 165 927 0	1/4	1000	750	1.00-2.9	8.80-25.7	2.03	17.99	40	ESP1-HT
C	SLBN030-L2000-S4Q	615 165 928 0	1/4	2000	1500	1.00-2.9	8.80-25.7	2.03	17.99	40	ESP1-HT
C	SLBN050-L1000-S4Q	615 165 929 0	1/4	1000	750	2.00-4.9	17.7-44.4	3.43	31.08	40	ESP1-HT
D	SLBN090-L800-S4Q	615 165 947 0	1/4	800	600	3.00-9.0	26.6-79.7	6.30	55.79	40	ESP1-HT PLUS
D	SLBN120-L550-S4Q	615 165 948 0	1/4	550	410	4.00-12	35.4-106.2	8.40	74.34	40	ESP1-HT PLUS

PUSH START - LOW VOLTAGE - CLUTCH CONTROL - SHUT OFF

E	SLBN012-A1000-S4Q	615 165 934 0	1/4	1000	750	0.2-1.18	1.76-10.4	0.83	7.28	32	ESP1
E	SLBN012-A2000-S4Q	615 165 935 0	1/4	2000	1500	0.2-1.18	1.76-10.4	0.83	7.28	32	ESP1
E	SLBN020-A1000-S4Q	615 165 936 0	1/4	1000	750	0.29-1.9	2.57-16.8	1.33	11.76	32	ESP1
F	SLBN030-A1000-S4Q	615 165 937 0	1/4	1000	750	1.00-2.9	8.80-25.7	2.03	17.99	40	ESP1-HT
F	SLBN030-A2000-S4Q	615 165 938 0	1/4	2000	1500	1.00-2.9	8.80-25.7	2.03	17.99	40	ESP1-HT
F	SLBN050-A1000-S4Q	615 165 939 0	1/4	1000	750	2.00-4.9	17.7-44.4	3.43	31.08	40	ESP1-HT
D	SLBN090-A800-S4Q	615 165 951 0	1/4	800	600	3.00-9.0	26.6-79.7	6.30	55.79	40	ESP1-HT PLUS
D	SLBN120-A550-S4Q	615 165 952 0	1/4	550	410	4.00-12	35.4-106.2	8.40	74.34	40	ESP1-HT PLUS

ESP C / ESP CA

Advanced controller SLC range

- Auto stop after elapsed time and auto reverse

- OK/NOK with rehit protection

- I/O for integration with PLC for multiple functions



A

- Easy to use
- Flexible keypad
- Multi languages

- Speed control at all steps of operation: start, rundown and final phase

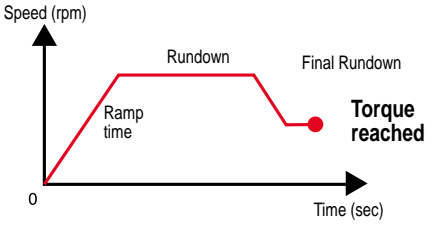



B

- Replace several tools by one
- Multi torque strategy

- Automatic sequence
- Up to 8 programs

- POKE YOKE & Fastening Assurance System

- User friendly interface
- Avoid time and Energy lost in programming

- USB key
- Results saving
- Statistics

- High Torque Phase (HLT)
- For all Self Tapping/ Cutting applications



- User friendly interface
- Avoid time and Energy lost in programming

- USB key
- Results saving
- Statistics

- High Torque Phase (HLT)
- For all Self Tapping/ Cutting applications

START-UP KIT to be ordered with the controller Including: Power cable and plug

PLUG	DESCRIPTION	PART NO.
A	European	615 917 201 0
B	US	615 917 203 0
C	UK	615 917 202 0
D	Chinese	615 917 206 0

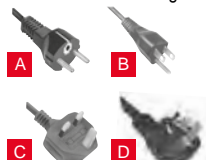

PIC REF	MODEL	PART NUMBER	TORQUE RANGE		SUPPLY VOLTAGE	DIMENSIONS						WEIGHT	
			Nm	in.lb		WIDTH		HEIGHT		DEPTH		kg	lb
A	ESP C 220V	615 165 480 0	0.5-15	4.4-132.7	AC 230V 50Hz	195	7.7	89	3.5	154	6.0	3.4	7.4
A	ESP C 110V	615 165 484 0	0.5-15	4.4-132.7	AC 120V 60Hz	195	7.7	89	3.5	154	6.0	3.4	7.4
A	ESP C LT 220V	615 165 481 0	0.5-7.0	4.4-61.9	AC 230V 50Hz	195	7.7	89	3.5	154	6.0	3.4	7.4
A	ESP C LT 110V	615 165 485 0	0.5-7.0	4.4-61.9	AC 120V 60Hz	195	7.7	89	3.5	154	6.0	3.4	7.4
B	ESP CA 220V	615 165 482 0	-	-	AC 230V 50 Hz	208	8.2	120	4.7	206	8.1	3.4	7.5
B	ESP CA LT 220V	615 165 483 0	-	-	AC 230V 50 Hz	208	8.2	120	4.7	206	8.1	3.4	7.5
B	ESP CA 110V	615 165 486 0	-	-	AC 120V 60 Hz	208	8.2	120	4.7	206	8.1	3.4	7.5
B	ESP CA LT 110V	615 165 487 0	-	-	AC 120V 60 Hz	208	8.2	120	4.7	206	8.1	3.4	7.5

High power screwdrivers - SLC

Torque Range

Performance of Electric Screwdrivers - Series SLC

MODEL	TORQUE RANGE (Nm)															SPEED RANGE rpm	SHAPE		
	0	0.5	1	1.5	2	3	4	5	6	6.5	7	8	9	10	11			12	13
SLC 30 / ESP C(A)LT	Soft joint															400-1200	In-line - Angle Head Pistol - Spindle		
	Hard joint																		
SLC 100 / ESP C(A)LT	Soft joint															130-400	In-line - Angle Head Pistol - Spindle		
	Hard joint																		
SLC 100 / ESP C(A)	Soft joint															200-600	In-line Pistol - Spindle Angle Head		
	Hard joint																		
	Soft joint & Hard joint																		
SLC 150 / ESP C(A)LT	Soft joint															70-220	In-line Pistol - Spindle		
	Hard joint																		
SLC 150 / ESP C(A)	Soft joint															100-320	In-line Pistol - Spindle		
	Hard joint																		

In-line and Angle head screwdrivers - SLC

0.5 to 15 Nm (4.4 to 132.7 in.lb) - 70 to 1200 rpm



A



B

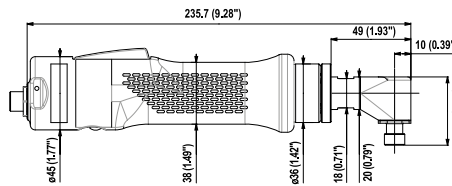
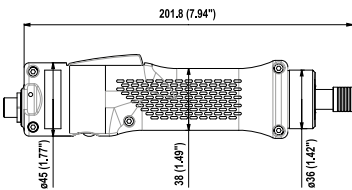

ACCESSORIES
see page 119

PIC REF	MODEL	PART NUMBER	OUTPUT HEX	FREE SPEED	TORQUE RANGE				WEIGHT		CONTROLLER
					SOFT Nm	SOFT in.lb	HARD Nm	HARD in.lb	kg	lb	
IN-LINE - LOW VOLTAGE - CURRENT CONTROL - SHUT OFF											
A	SLC030-L1200-C4Q	615 165 500 0	1/4	400-1200	0.5-2	4.4-17.7	0.6-3	5.3-26.5	0.5	1.1	ESP C(A) LT
A	SLC100-L600-C4Q	615 165 466 0	1/4	130-400	0.5-4	4.4-35.4	0.8-6	7.1-53.1	0.5	1.1	ESP C(A) LT
				200-600	2.0-8	17.7-70.8	2.0-10	17.7-88.5	0.5	1.1	ESP C(A)
A	SLC150-L320-C4Q	615 165 467 0	1/4	70-220	0.5-6	4.4-53.1	1.5-7	13.3-61.9	0.5	1.1	ESP C(A) LT
				100-320	2.0-12	17.7-106.2	2.0-15	17.7-132.7	0.5	1.1	ESP C(A)
ANGLE HEAD - LOW VOLTAGE - CURRENT CONTROL - SHUT OFF											
B	SLC030-L1200-C90A4H	615 165 478 0	1/4	400-1200	0.5-2	4.4-17.7	0.6-3	5.3-26.5	0.7	1.5	ESP C(A) LT
B	SLC100-L600-C90A4H	615 165 479 0	1/4	130-400	0.5-4	4.4-35.4	0.8-6	7.1-53.1	0.7	1.5	ESP C(A) LT
				200-600	2.0-8	17.7-70.8	2.0-10	17.7-88.5	0.7	1.5	ESP C(A)

Pistol grip screwdrivers - SLC

0.5 to 15 Nm (4.4 to 132.7 in.lb) - 70 to 1200 rpm

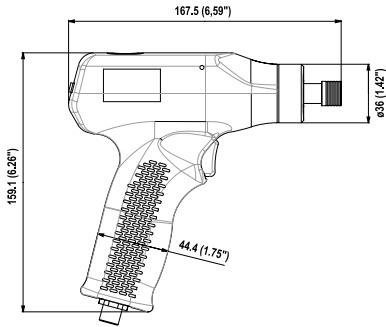

PIC REF	MODEL	PART NUMBER	OUTPUT HEX	FREE SPEED	TORQUE RANGE				WEIGHT		CONTROLLER
					SOFT Nm	SOFT in.lb	HARD Nm	HARD in.lb	kg	lb	
PISTOL GRIP - LOW VOLTAGE - CURRENT CONTROL - SHUT OFF											
A	SLC030-P1200-C4Q	615 165 488 0	1/4	400-1200	0.5-2	4.4-17.7	0.6-3	5.3-26.5	0.6	1.3	ESP C(A) LT
A	SLC100-P600-C4Q	615 165 462 0	1/4	130-400	0.5-4	4.4-35.4	0.8-6	7.1-53.1	0.6	1.3	ESP C(A) LT
			1/4	200-600	2.0-8	17.7-70.8	2.0-10	17.7-88.5	0.6	1.3	ESP C(A)
A	SLC150-P320-C4Q	615 165 463 0	1/4	70-220	0.5-6	4.4-53.1	1.5-7	13.3-61.9	0.6	1.3	ESP C(A) LT
			1/4	100-320	2.0-12	17.7-106.2	2.0-15	17.7-132.7	0.6	1.3	ESP C(A)
PISTOL GRIP WITH TOP CONNECTOR - CURRENT CONTROL - SHUT OFF											
B	SLC030-T1200-C4Q	615 165 489 0	1/4	400-1200	0.5-2	4.4-17.7	0.6-3	5.3-26.5	0.6	1.3	ESP C(A) LT
B	SLC100-T600-C4Q	615 165 464 0	1/4	130-400	0.5-4	4.4-35.4	0.8-6	7.1-53.1	0.6	1.3	ESP C(A) LT
			1/4	200-600	2.0-8	17.7-70.8	2.0-10	17.7-88.5	0.6	1.3	ESP C(A)
B	SLC150-T320-C4Q	615 165 465 0	1/4	70-220	0.5-6	4.4-53.1	1.5-7	13.3-61.9	0.6	1.3	ESP C(A) LT
			1/4	100-320	2.0-12	17.7-106.2	2.0-15	17.7-132.7	0.6	1.3	ESP C(A)

SLC - Automation - Remote start

0.5 to 15 Nm (4.4 to 132.7 in.lb) - 70 to 1200 rpm

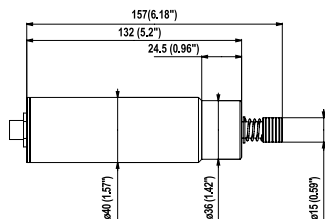

PIC REF	MODEL	PART NUMBER	OUTPUT HEX	FREE SPEED	TORQUE RANGE				WEIGHT		CONTROLLER
					SOFT Nm	SOFT in.lb	HARD Nm	HARD in.lb	kg	lb	
AUTOMATION - REMOTE START											
A	SLC030-F1200-C4Q	615 165 490 0	1/4	400-1200	0.5-2	4.4-17.7	0.6-3	5.3-26.5	0.5	1.1	ESP C(A) LT
A	SLC100-F600-C4Q	615 165 468 0	1/4	130-400	0.5-4	4.4-35.4	0.8-6	7.1-53.1	0.5	1.1	ESP C(A) LT
			1/4	200-600	2.0-8	17.7-70.8	2.0-10	17.7-88.5	0.5	1.1	ESP C(A)
A	SLC150-F320-C4Q	615 165 469 0	1/4	70-220	0.5-6	4.4-53.1	1.5-7	13.3-61.9	0.5	1.1	ESP C(A) LT
			1/4	100-320	2.0-12	17.7-106.2	2.0-15	17.7-132.7	0.5	1.1	ESP C(A)

Accessories

SLBN / SLC

ACCESSORIES INCLUDED

	SLBN	SLC
• Suspension bail		615 360 222 0
• Torque fixing ring for SLB003	615 225 053 0	
• Torque fixing ring for SLB012/020	615 548 218 0	
• Torque fixing ring for SLB030/050	615 548 219 0	
• Tool / Controller cable L = 2.5m (8.2ft)	-	615 360 223 0
• Cable L = 1.83m (6ft)	615 397 416 0	

OPTIONAL ACCESSORIES

ITEM	SLBN	SLC
------	------	-----

SLBN Tools

1	Control Box	615 932 709 0
2	Shielded cable 3m for ESP2-A	615 917 721 0
	• Shielded cable 5m	615 917 725 0
	• Shielded cable 10m	615 917 726 0
3	Spiral cable 2m (6.5 ft)	615 360 838 0
4	Pistol grip (Trigger) for SLB030/050	615 397 918 0
4	Pistol grip (Push) for SLB030/050	615 397 919 0
4	Pistol grip (Push) for SLB012/020	77562
	• Cable, 10m (32.8 ft)	615 360 379 0
	• Wall fixing plate for ESP1-HT	615 571 085 5
	• Clamp ring for SLB012/020	615 399 057 0
	• Clamp ring for SLB030/050	615 397 815 0
	• Adaptor M20 SLB012/020	615 548 151 5
	• Adaptor M20 SLB 030/050	615 548 152 5
5	Angle head for SLB012/020	615 398 033 0
5	Angle head for SLB030/050	615 398 034 0

SLC Tools

6	Side Handle	615 397 016 0
7	Color ring (3)	615 397 008 5
	• Cable extension L = 2m (6.6ft)	615 917 593 0
8	Spiral cable L = 2m (6.6ft)	615 917 594 0
	• M20 adaptor	615 567 132 0
9	Bit tray	615 936 068 0
10	Switch box	615 936 069 0

Spring Loaded Shafts and Bearings Support

11	Bit Adaptor	103782
12	Spring Loaded Shaft 25mm (1") stroke, 3/8" Sq Drive	108342
13	Shaft Support and Nose Mount	108412

Nose Mounts for SLC-M20

14	Nose Mount	205 052 876 3
15	Flange	205 052 875 3

Offset Head and Spring Loaded Shaft

12	Spring loaded shaft 25mm (1") stroke, 3/8" square drive	108342
16	Offset Head, Offset 30mm (1.18")	384993

Screwdriver Bit Adaptor

17	3/8" Square to 1/4" HexPower Adaptor	108322
----	--------------------------------------	--------

Balancers and Holster

18	Spring Suspension Balancer	50522
19	Tool holster DTH-42	107892
20	Tool holster DTH90	615 812 119 0

Ergonomic accessories

21	D53 - Linear & Folder arms	see page 168
22	TRA - Telescopic arms	see page 178
23	D57, D58 - Balancing arms	see page 186
24	Torque tube	see page 183



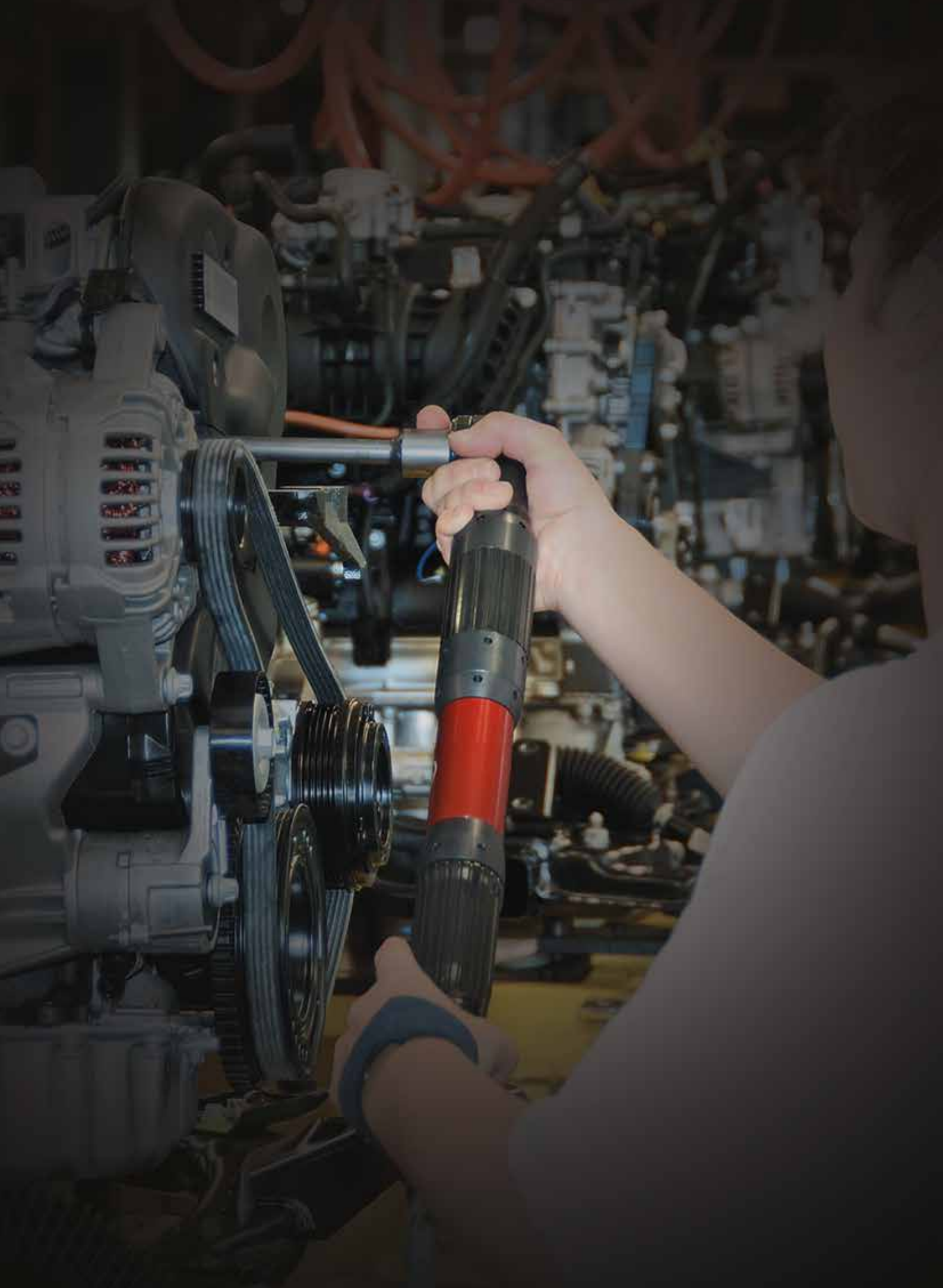

Pneumatic fastening tools

Shut Off, Non Shut Off, Direct Drive, Automatic Reverse



T shape grip for better balance to enhance operator comfort

Powerful, efficient, Dryline™ motor

CLUTCH AND MOTOR PROLONGING TOOL LIFE

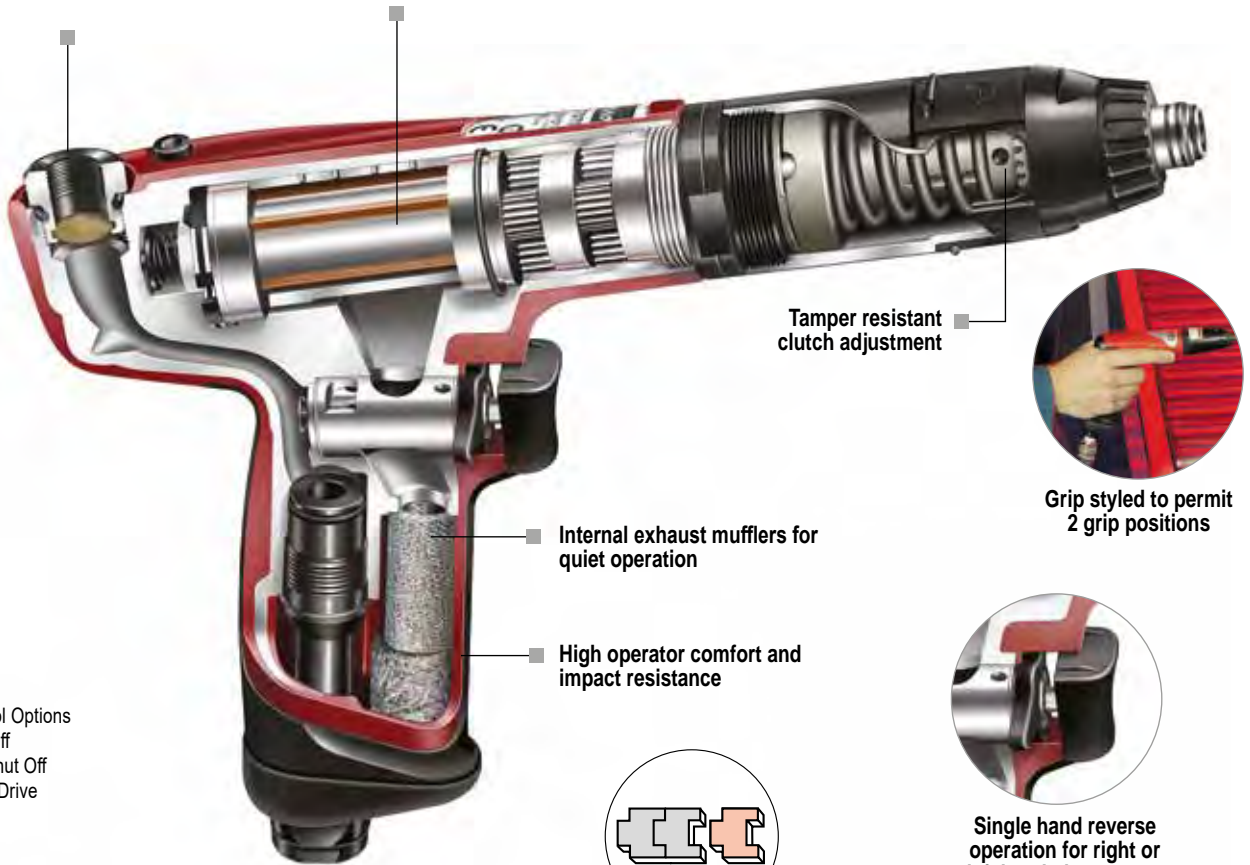

- 3 Control Options
- Shut Off
 - Non Shut Off
 - Direct Drive

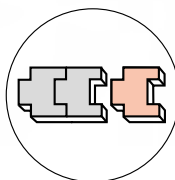







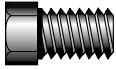
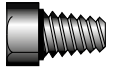

Tool selection

CRITERIA

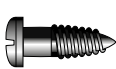
- Type of Fastener/Component
- Joint integrity
- Torque Required
- Tool Orientation and Operator Reference
- Productivity
- Access

TYPE OF FASTENER/COMPONENT

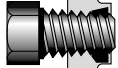
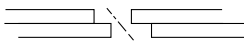
FASTENER/COMPONENT	RECOMMENDED TOOL TYPE
Machine Screw/Nut 	Shut Off/Impulse/Non Shut Off
Thread Rolling/Forming 	Shut Off/HLT/Impulse/Direct Drive
Self Tapping 	Non Shut Off/HLT/Direct Drive
Self Tapping in Plastic/ Thin Materials 	Shut Off/HLT
Self Drilling 	Non Shut Off/HLT/Direct Drive
Wood Screws 	Non Shut Off/Direct Drive

FASTENER/COMPONENT	RECOMMENDED TOOL TYPE
Screws with Adhesive 	HLT/Non Shut Off/Impulse
Self Lock Nuts 	HLT/Non Shut Off/Impulse
Misaligned Holes 	HLT
Variable Size Holes 	HLT
Fragile Components 	HLT/Low Voltage Screwdrivers



Tool selection

FASTENER TORQUE VALUES

MACHINE SCREWS						THREAD FORMING/ ROLLING SCREWS
ISO	4.6	5.8	8.8	10.9	12.9	8.8
THREAD SIZE	RECOMMENDED TORQUE (NM)					RECOMMENDED TORQUE (NM)
M1.6	0.07	0.12	0.19	–	–	–
M2	0.15	0.24	0.38	–	–	0.5
M2.2	0.19	0.31	0.51	–	–	–
M2.5	0.28	0.48	0.77	–	–	–
M3	0.51	0.85	1.4	1.9	2.3	1.4
M3.5	0.80	1.34	2.2	3.0	3.6	–
M4	1.20	2.00	3.2	4.5	5.4	3.2
M5	2.40	4.00	6.4	9.0	10.7	6.5
M6	4.10	6.80	10.9	15.3	18.3	11
M8	9.80	16.3	26.1	36.8	44.1	26
M10	19.3	32.2	51.5	72	86.9	52
M12	33.6	56.0	90	126	151	91
M14	53.0	89.0	142	200	239	–
M16	82.0	136	218	307	368	–
M18	114	190	304	428	513	–
M20	160	266	426	598	718	–
M22	215	358	573	806	967	–

SELF TAPPING/DRILLING SCREWS	
THREAD SIZE	RECOMMENDED TORQUE (NM)
ST2.2 (B2)	0.2
ST2.9 (B4)	1.0
ST3.5 (B6)	1.8
ST4.2 (B8)	2.9
ST4.8 (B10)	4.2
ST5.5 (B12)	6.7
ST6.3 (B14)	9.1

CONVERSION FACTORS

Nm x 141.6 = oz in
 Nm x 8.851 = in lb
 Nm x 0.73756 = ft lb
 Nm x 0.102 = kgf m/kpm
 Nm x 10.2 = kgf cm

Torque figures should be used as a guide only
 Table assumes fasteners are new, lightly lubricated and of a standard finish
 For lock nuts with a nylon insert, +10 %
 Torque values are recommended values for a working pressure of 6,3 bar (90 PSIG)

For non metric threads please use the following data as a guide.

Recommended Maximum Torque Values – UNC Thread

THREAD SIZE	QUALITY P		QUALITY S		QUALITY T	
	Nm	ft.lb	Nm	ft.lb	Nm	ft.lb
1/4	5.43	4	10.3	7.6	11	8.2
5/16	11.2	8.3	21.3	15.7	23	16.9
3/8	19.9	14.7	37.9	27.9	40	30.2
7/16	31.9	23.5	60.7	44.8	65	48.31
1/2	48.8	36	92.7	68.4	100	73.8
9/16	70.4	51.9	134	98.8	144	106
5/8	97.4	71.8	185	136.4	200	147.5
3/4	178	131.3	338	249.3	364	268.5
7/8	279	205.8	530	391	572	422
1	418	308.3	795	586	858	633
1 1/8	593	437.4	1126	830	1216	897
1 1/4	837	617.3	1591	1173	1717	1266
1 3/8	1096	808.4	2083	1536	2248	1658
1 1/2	1456	1074	2767	2041	2987	2203

Recommended Maximum Torque Values – UNF Threads

THREAD SIZE	QUALITY P		QUALITY S		QUALITY T	
	Nm	ft.lb	Nm	ft.lb	Nm	ft.lb
1/4	6.3	4.6	11.9	8.8	12.9	9.5
5/16	12.5	9.2	23.8	17.5	25.7	18.9
3/8	22.7	16.7	43.2	31.9	46.6	34.4
7/16	35.9	26.5	68.2	50.3	73.6	54.3
1/2	55.4	40.9	105	77.4	114	84
9/16	79	58.3	150	111	162	119
5/8	111	81.9	210	155	227	167
3/4	195	144	370	273	399	294
7/8	309	228	587	433	634	468
1	459	339	873	644	942	695
1 1/8	667	492	1267	934	1368	1009
1 1/4	925	682	1757	1296	1896	1398
1 3/8	1252	923	2378	1754	2567	1893
1 1/2	1642	1211	3119	2300	3367	2482

Quality P = approximately ISO 4.6 Quality S/T = approximately ISO 8.8 Quality S = ANSI Grade 5



Productivity and Ergonomics

ACCESS



90° Angle Heads



Crowfoot
Open Ended Wrenches

ERGONOMIC BENEFITS

- Lightweight
- Short Length
- Light Start Load

Pistol options of 'P' or 'T' style to suit the application and operator preference

'Warm feel' friction grip

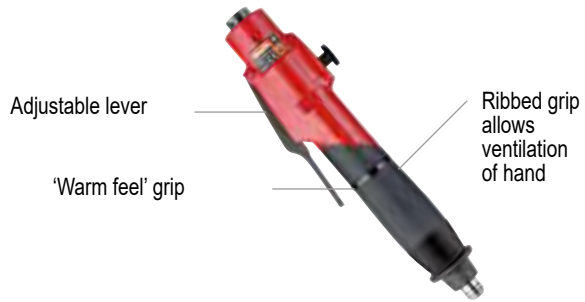
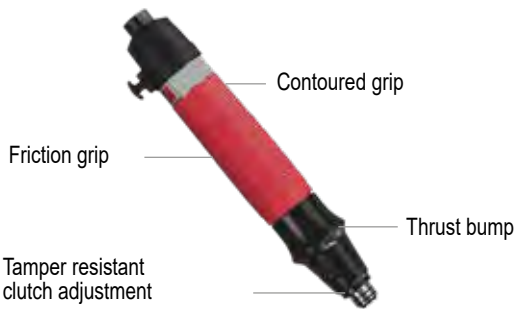
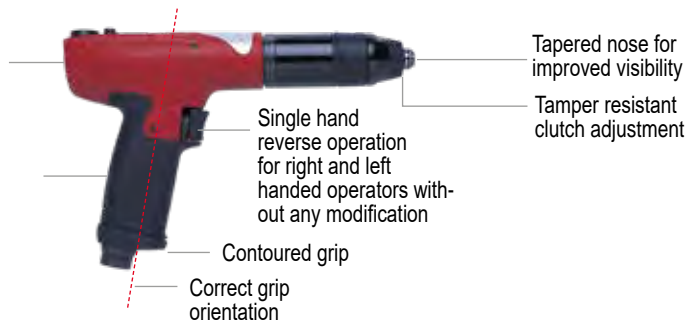

For low vibration exposure and high productivity, select shut off tools where possible

TOOL ORIENTATION AND OPERATOR PREFERENCE

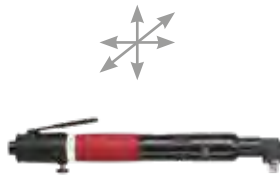

P Shape

Self Tapping/Forming/Cutting Screws
Multi orientation
Top air inlet
Requires balanced tool

Use P Shape - arm in line with body of tool for thrust
Use P Shape - allows wrist to rotate into position
Can only use T Shape
Use T Shape - especially with screwfeeder

Button Reverse versus Rotary Reverse

Rapid Reverse Required
Thread Chasing Cleaning
Rivnuts/Threaded Fasteners
Long Periods in Reverse

Use button reverse
Use button reverse (auto reverse for blind holes)
Use auto reverse tools
Use rotary reverse

Push Start versus Lever Start

Fast Cycle Rate
Single Hand Operation Required
Need to Align/Position Components First

Use push start
Use push start
Use lever start or push + trigger start (SBP/SDP only)

Modularity

SD SERIES

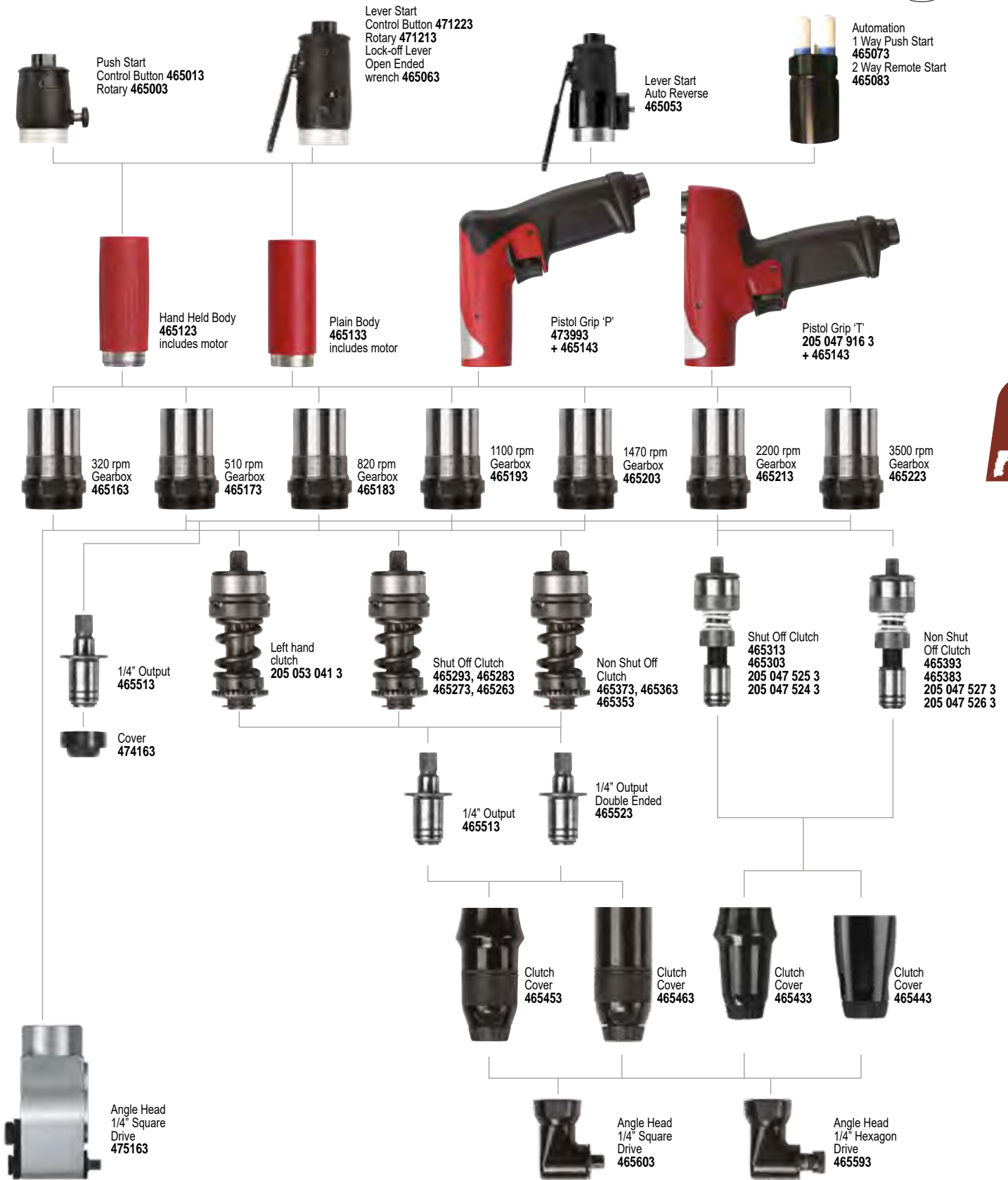
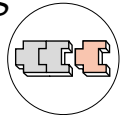

Modularity, a concept for all Desoutter pneumatic screwdrivers range

Screwdriver Torque Ranges

Torque output of the range of shut off and non shut off screwdrivers is controlled by the type of spring in the clutch assembly.

The overall torque range, together with that of the factory fitted spring on a soft joint to ISO5393 are listed in the tables on the following pages. The chart below provides an indication of the torque ranges for the optional colour coded clutch springs together with their respective part numbers (some are included with certain tools) As a general rule, the tool should be fitted with a spring which ensures the torque required falls within 20 to 80 % of the operating range.

Please note that the torque range of specific speed tools may alter slightly from that shown below and for this reason the chart should be used as a guide only.

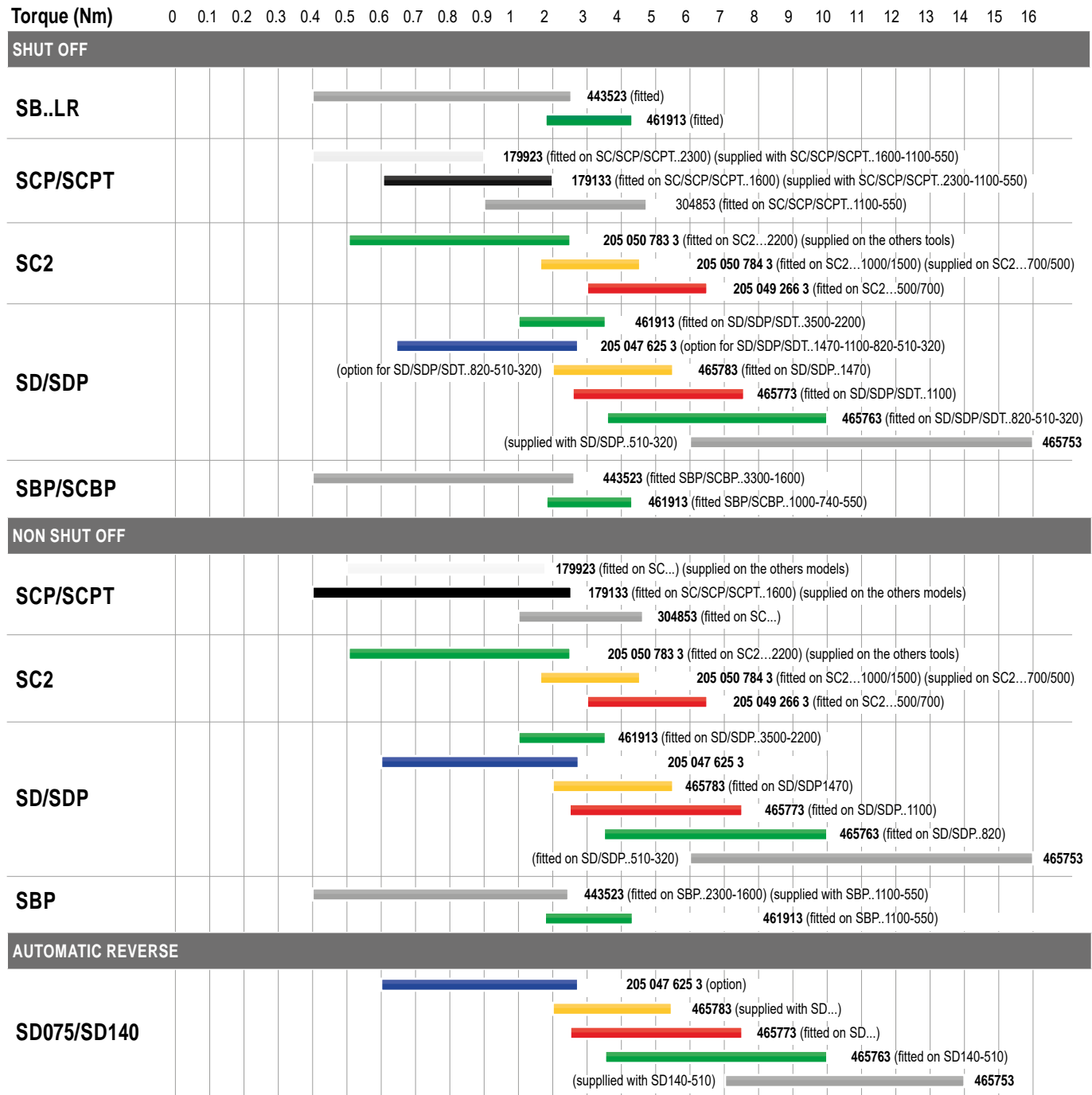

Tool Types and Torque Ranges

Torque : Nm (in.lb)

0 1 5 10 15 20 30 40 50 100 150 200 250

SHUT OFF

Push Start	SB	0.4-2.5 (3.5-22 in.lb)
	SC2	0.5-6.5 (4.4-57.5 in.lb)
	SD	0.6-16 (5.3-122 in.lb)
Lever Start	SB	0.5-4.7 (4.4-41.6 in.lb)
	SC2	0.5-6.5 (4.4-57.5 in.lb)
	SD	0.6-16 (5.3-122 in.lb)
Push and Trigger Start	SBP	0.4-4.7 (3.5-41.6 in.lb)
Trigger Start	SCBP / SCP	0.4-4.7 (3.5-41.6 in.lb)
	SDP	1.0-16.0 (8.8-142 in.lb)
Trigger Start, Top Air Inlet	SDT	1.0-16.0 (8.8-142 in.lb)
Push Start, Top Air Inlet	SCPT	0.4-4.7 (3.5-41.6 in.lb)
Angle head	SC	0.4-4.7 (3.5-41.6 in.lb)
	SD	2.5-27 (22.1-239 in.lb)
	SH	2.5-200 (22.1-1770 in.lb)

NON SHUT OFF

Push Start	SD	0.6-10 (5.3-88.5 in.lb)
Lever Start	SD	0.6-10 (5.3-88.5 in.lb)
Trigger Start	SCP	0.4-4.4 (3.5-38.9 in.lb)
	SDP	0.6-10 (5.3-88.5 in.lb)
Push Start, Top Air Inlet	SCPT	0.4-4.4 (3.5-38.9 in.lb)

AUTOMATIC REVERSE

SD	0.6-14 (5.3-124 in.lb)
-----------	------------------------

DIRECT DRIVE

Trigger start	SDP	1.0-14 (8.8-124 in.lb)
Angle head	SD	1.5-13 (13.3-115 in.lb)
Angle Wrench	H410	3-105 (26.5-929 in.lb)

Torque : Nm (ft.lb)

0 1 5 10 15 20 30 40 50 100 200 300 400 500

IMPULSE

Lever Start	Shut off	5-25 (4-18 ft.lb)
	Non Shut off	20-31 (15-23 ft.lb)
Trigger Start	Shut off	5-450(4-332 ft.lb)
	Non Shut off	9-240 (6.6-177 ft.lb)

Screwdrivers - Shut off - Push start

0.09 to 16 Nm (0.8 to 142 in.lb) - 320 to 3500 rpm



Model	ø A mm (in.)	ø B mm (in.)	L mm (in.)
SB..	32 (1.26)	36 (1.42)	197 (7.76)
SC2			245 (9.65)
SD023..3500	38.7 (1.52)	44 (1.73)	227 (8)
SD035..2200	38.7 (1.52)	44 (1.73)	227 (8)
SD055..1470	38.7 (1.52)	44 (1.73)	253 (10)
SD075..1100	38.7 (1.52)	44 (1.73)	253 (10)
SD100..820	38.7 (1.52)	44 (1.73)	253 (10)
SD140..510	38.7 (1.52)	44 (1.73)	253 (10)
SD160..320	38.7 (1.52)	44 (1.73)	253 (10)



ACCESSORIES
see page 142

Types A to B, 1/4" double ended and 5mm bit holder optional

PIC REF	MODEL	PART NUMBER	FREE SPEED	OUTPUT HEX	TORQUE RANGE		FITTED SPRING		WEIGHT		AIR FLOW		AIR INLET		HOSE INT.Ø	
			rpm	in.	Nm	in.lb	Nm	in.lb	kg	lb.	l/s	cfm	in.	nm	in.	
A	SB011-AB1600-S4Q	1460644	1600	1/4	0.4-1.1	3.5-9.7	0.4-1.1	3.5-9.7	0.42	0.93	4.1	8.7	1/8	5	3/16	
A	SB015-AB1100-S4Q	1460634	1100	1/4	0.4-1.5	3.5-13	0.4-1.5	3.5-13	0.42	0.93	4.1	8.7	1/8	5	3/16	
A	SB025-AB750-S4Q	1460624	750	1/4	0.4-2.5	3.5-22	0.4-2.5	3.5-22	0.42	0.93	4.1	8.7	1/8	5	3/16	
A	SB025-AB500-S4Q	1460684	500	1/4	0.4-2.5	3.5-22	0.4-2.5	3.5-22	0.42	0.93	4.1	8.7	1/8	5	3/16	
B	SB011-AR1600-S4Q	1460524	1600	1/4	0.4-1.1	3.5-9.7	0.4-1.1	3.5-9.7	0.42	0.93	4.1	8.7	1/8	5	3/16	
B	SB015-AR1100-S4Q	1460514	1100	1/4	0.4-1.5	3.5-13	0.4-1.5	3.5-13	0.42	0.93	4.1	8.7	1/8	5	3/16	
B	SB025-AR750-S4Q	1460504	750	1/4	0.4-2.5	3.5-22	0.4-2.5	3.5-22	0.42	0.93	4.1	8.7	1/8	5	3/16	
B	SB025-AR500-S4Q	1460564	500	1/4	0.4-2.5	3.5-22	0.4-2.5	3.5-22	0.42	0.93	4.1	8.7	1/8	5	3/16	
C	SC2-025-A2200-S4Q	205 147 269 4	2200	1/4	0.5-2.5	4.4-22	0.5-2.5	4.4-22.1	0.69	1.52	7.0	14.8	1/4	6	1/4	
C	SC2-035-A1500-S4Q	205 147 268 4	1450	1/4	0.5-3.5	4.4-30.8	1.7-3.5	15.0-30.9	0.69	1.52	7.0	14.8	1/4	6	1/4	
C	SC2-045-A1000-S4Q	205 147 267 4	1000	1/4	0.5-4.5	4.4-39.6	1.7-4.5	15.0-39.8	0.69	1.52	7.0	14.8	1/4	6	1/4	
C	SC2-055-A700-S4Q	205 147 266 4	700	1/4	0.5-5.5	4.4-48.4	3.0-5.5	26.5-48.6	0.69	1.52	7.0	14.8	1/4	6	1/4	
C	SC2-065-A500-S4Q	205 147 265 4	480	1/4	0.5-6.5	4.4-57.2	3.0-6.5	26.5-57.5	0.69	1.52	7.0	14.8	1/4	6	1/4	
D	SD035-AB2200-S4Q	1462824	2200	1/4	1.0-3.5	8.9-31	1.0-3.5	8.9-31	0.73	1.61	8.7	18.4	1/4	10	3/8	
D	SD055-AB1470-S4Q	1462814	1470	1/4	0.6-5.5	5.3-48.7	2.0-5.5	17.7-48.7	0.89	1.96	8.7	18.4	1/4	10	3/8	
D	SD075-AB1100-S4Q	1462804	1100	1/4	0.6-7.5	5.3-66.4	2.5-7.5	22.0-66.4	0.89	1.96	8.7	18.4	1/4	10	3/8	
D	SD100-AB820-S4Q	1462794	820	1/4	0.6-10	5.3-88.5	3.5-10	31.0-88.5	0.89	1.96	8.7	18.4	1/4	10	3/8	
D	SD140-AB510-S4Q	1462784	510	1/4	0.6-14	5.3-124	3.5-10	31.0-88.5	0.89	1.96	8.7	18.4	1/4	10	3/8	
D	SD160-AB320-S4Q	1462774	320	1/4	0.6-16	5.3-142	3.5-10	31.0-88.5	0.89	1.96	8.7	18.4	1/4	10	3/8	
E	SD055-AR1470-S4Q	1462744	1470	1/4	0.6-5.5	5.3-48.7	2.0-5.5	17.7-48.7	0.89	1.96	8.7	18.4	1/4	10	3/8	
E	SD075-AR1100-S4Q	1462734	1100	1/4	0.6-7.5	5.3-66.4	2.5-7.5	22.1-66.4	0.89	1.96	8.7	18.4	1/4	10	3/8	
E	SD100-AR820-S4Q	1462724	820	1/4	0.6-10	5.3-88.5	3.5-10	31.0-88.5	0.89	1.96	8.7	18.4	1/4	10	3/8	
E	SD140-AR510-S4Q	1462714	510	1/4	0.6-14	5.3-124	3.5-10	31.0-88.5	0.89	1.96	8.7	18.4	1/4	10	3/8	
E	SD160-AR320-S4Q	1462704	320	1/4	0.6-16	5.3-142	3.5-10	31.0-88.5	0.89	1.96	8.7	18.4	1/4	10	3/8	

Screwdrivers - Shut off - Lever start

0.4 to 16 Nm (3.5 to 142 in.lb) - 320 to 3500 rpm

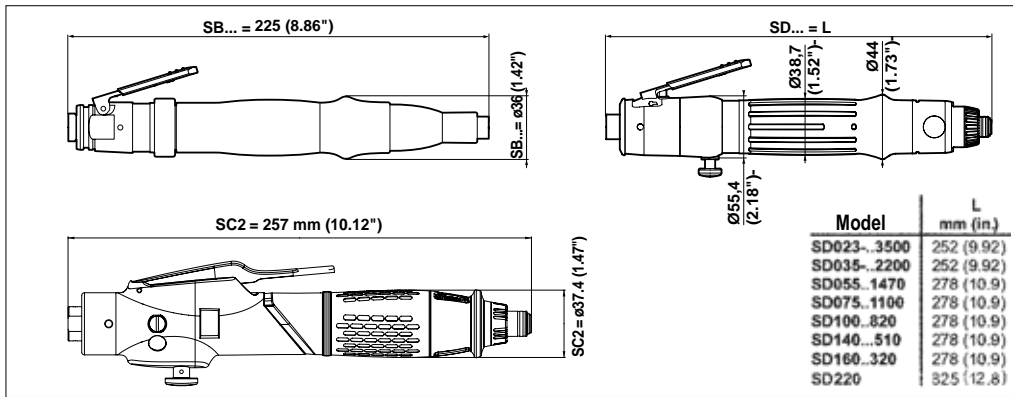
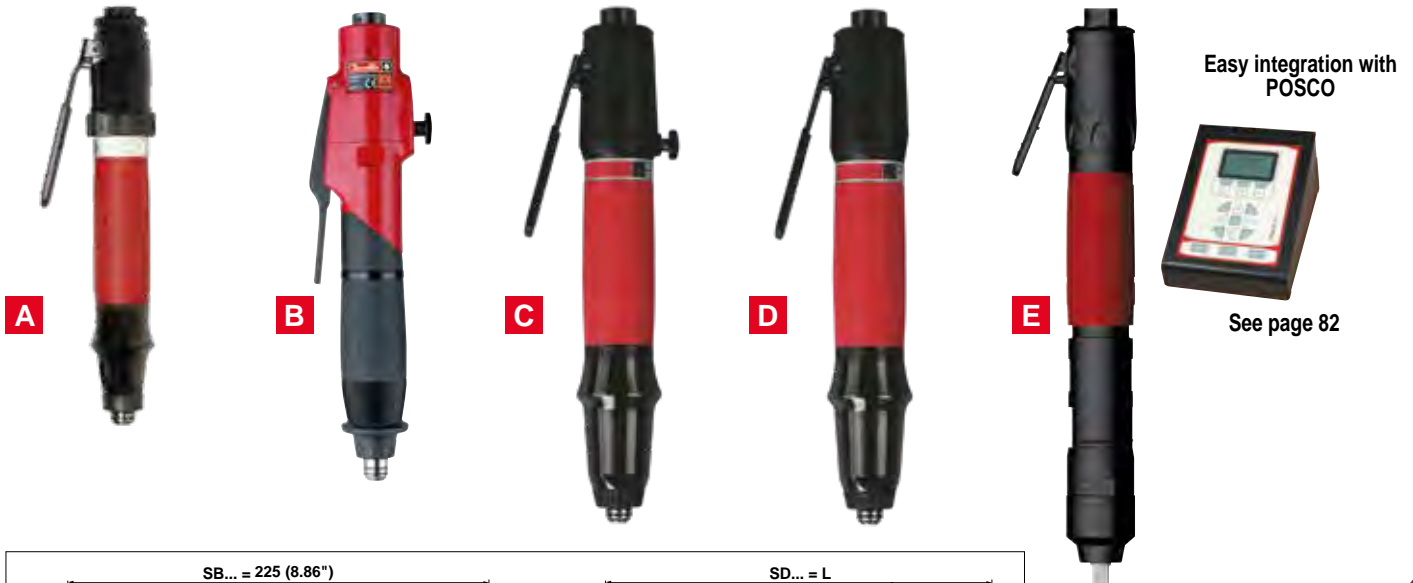

ACCESSORIES
see page 142

PIC REF	MODEL	PART NUMBER	FREE SPEED	OUTPUT DRIVE	TORQUE RANGE		FITTED SPRING		WEIGHT		AIR FLOW		AIR INLET		HOSE INT.Ø	
					Nm	in.lb	Nm	in.lb	kg	lb.	l/s	cfm	in.	nm	in.	
A	SB043-LR1050-S4Q	205 147 507 4	1050	1/4 Hex	0.4-4.3	3.5-38	1.9-4.3	16.7-37.8	0.61	1.34	7.3	15.5	1/8	6	1/4	
A	SB047-LR500-S4Q	205 147 506 4	500	1/4 Hex	0.4-4.7	3.5-41.6	1.9-4.7	16.7-41.4	0.61	1.34	7.3	15.5	1/8	6	1/4	
B	SC2-025-L2200-S4Q	205 147 283 4	2200	1/4 Hex	0.5-2.5	4.4-22	0.5-2.5	4.4-22.1	0.69	1.52	7.0	14.8	1/4	6	1/4	
B	SC2-035-L1500-S4Q	205 147 282 4	1450	1/4 Hex	0.5-3.5	4.4-30.8	1.7-3.5	15.0-30.9	0.69	1.52	7.0	14.8	1/4	6	1/4	
B	SC2-045-L1000-S4Q	205 147 281 4	1000	1/4 Hex	0.5-4.5	4.4-39.6	1.7-4.5	15.0-39.8	0.69	1.52	7.0	14.8	1/4	6	1/4	
B	SC2-055-L700-S4Q	205 147 280 4	700	1/4 Hex	0.5-5.5	4.4-48.4	3.0-5.5	26.5-48.6	0.69	1.52	7.0	14.8	1/4	6	1/4	
B	SC2-065-L500-S4Q	205 147 279 4	480	1/4 Hex	0.5-6.5	4.4-57.2	3.0-6.5	26.5-57.5	0.69	1.52	7.0	14.8	1/4	6	1/4	
C	SD055-LB1470-S4Q	1463074	1470	1/4 Hex	0.6-5.5	5.3-48.7	2.0-5.5	17.7-48.7	0.92	2.03	8.7	18.4	1/4	10	3/8	
C	SD075-LB1100-S4Q	1463064	1100	1/4 Hex	0.6-7.5	5.3-66.4	2.5-7.5	22.1-66.4	0.92	2.03	8.7	18.4	1/4	10	3/8	
C	SD100-LB820-S4Q	1463054	820	1/4 Hex	0.6-10	5.3-88.5	3.5-10	31.0-88.5	0.92	2.03	8.7	18.4	1/4	10	3/8	
C	SD140-LB510-S4Q	1463044	510	1/4 Hex	0.6-14	5.3-124	3.5-10	31.0-88.5	0.92	2.03	8.7	18.4	1/4	10	3/8	
C	SD160-LB320-S4Q	1463034	320	1/4 Hex	0.6-16	5.3-142	3.5-10	31.0-88.5	0.92	2.03	8.7	18.4	1/4	10	3/8	
D	SD023-LR3500-S4Q	1463024	3500	1/4 Hex	1.0-2.3	8.9-20.4	1.0-2.3	8.9-20.4	0.76	1.67	8.7	18.4	1/4	10	3/8	
D	SD055-LR1470-S4Q	1463004	1470	1/4 Hex	0.6-5.5	5.3-48.7	2.0-5.5	17.7-48.7	0.92	2.03	8.7	18.4	1/4	10	3/8	
D	SD075-LR1100-S4Q	1462994	1100	1/4 Hex	0.6-7.5	5.3-66.4	2.5-7.5	22.1-66.4	0.92	2.03	8.7	18.4	1/4	10	3/8	
D	SD100-LR820-S4Q	1462984	820	1/4 Hex	0.6-10	5.3-88.5	3.5-10	31.0-88.5	0.92	2.03	8.7	18.4	1/4	10	3/8	
D	SD140-LR510-S4Q	1462974	510	1/4 Hex	0.6-14	5.3-124	3.5-10	31.0-88.5	0.92	2.03	8.7	18.4	1/4	10	3/8	
D	SD160-LR320-S4Q	1462964	320	1/4 Hex	0.6-16	5.3-142	3.5-10	31.0-88.5	0.92	2.03	8.7	18.4	1/4	10	3/8	
E	SD220-LR320-S4Q	205 147 937 4	320	1/4 Hex	9-16	27-142	9-16	27-142	1.4	3.1	8.7	18.4	1/4	10	3/8	
E	SD220-LR320-S10S	205 147 979 4	320	3/8 Sq	9-22	27-198	9-19	27-168	1.4	3.1	8.7	18.4	1/4	10	3/8	

Screwdrivers - Shut off - Pistol grip

0.4 to 16 Nm (3.5 to 142 in.lb) - 180 to 3500 rpm



Model	ØA		L	
	mm (in.)	mm (in.)	mm (in.)	mm (in.)
SBP..	31 (1.22)	182 (7.17)		
SCBP..	31 (1.22)	182 (7.17)		
SCP...	34 (1.34)	228 (8.97)		
SCPT...	34 (1.34)	230 (9.06)		
SDP023..3400	36 (1.42)	194 (7.64)		
SDP035..2100	36 (1.42)	194 (7.64)		
SDP055..1400	36 (1.42)	220 (8.66)		
SDP075..1050	36 (1.42)	220 (8.66)		
SDP100..780	36 (1.42)	220 (8.66)		
SDP140..490	36 (1.42)	220 (8.66)		
SDP160..300	36 (1.42)	220 (8.66)		
SDP045..180	36 (1.42)	220 (8.66)		

Model	L	
	mm (in.)	mm (in.)
SDT035..1100	212 (8.35)	
SDT035..2200	212 (8.35)	
SDT055..1470	238 (9.37)	
SDT075..1100	238 (9.37)	
SDT100..800	238 (9.37)	
SDT140..510	238 (9.37)	
SDT160..320	238 (9.37)	

ACCESSORIES voir page 142

Types D and E, Top air inlet

PIC REF	MODEL	PART NUMBER	FREE SPEED	OUTPUT HEX	TORQUE RANGE		FITTED SPRING		WEIGHT		AIR FLOW		AIR INLET		HOSE INT. Ø	
					rpm	in.	Nm	in.lb	Nm	in.lb	kg	lb.	l/s	cfm	in.	mm

PUSH AND TRIGGER START

A	SBP021-T2300-S4Q	1462144	2300	1/4	0.4-2.1	3.5-18.6	0.4-2.1	3.5-18.6	0.82	1.81	6.5	13.8	1/8	6	1/4
A	SBP021-T1600-S4Q	1462154	1600	1/4	0.4-2.1	3.5-18.6	0.4-2.1	3.5-18.6	0.82	1.81	6.5	13.8	1/8	6	1/4
A	SBP043-T1100-S4Q	1462164	1100	1/4	0.4-4.3	3.5-38	1.8-4.3	15.9-38.0	0.82	1.81	6.5	13.8	1/8	6	1/4
A	SBP047-T550-S4Q	1462174	550	1/4	0.4-4.7	3.5-41.6	1.8-4.7	15.9-41.5	0.82	1.81	6.5	13.8	1/8	6	1/4

TRIGGER START

A	SCBP043-T1100-S4Q	1466354	1100	1/4	0.4-4.3	3.5-38	1.8-4.3	15.9-38	0.82	1.81	6.5	13.8	1/8	6	1/4
A	SCBP044-T740-S4Q	1466344	740	1/4	0.4-4.4	3.5-39	1.8-4.4	15.9-39	0.82	1.81	6.5	13.8	1/8	6	1/4
A	SCBP047-T550-S4Q	1466334	550	1/4	0.4-4.7	3.5-41.6	1.8-4.7	15.9-41.6	0.82	1.81	6.5	13.8	1/8	6	1/4
B	SCP021-T1600-S4Q	1456744	1600	1/4	0.4-2.1	3.5-18.6	0.6-2.1	5.3-18.6	0.86	1.89	6.5	13.8	1/8	6	1/4
B	SCP043-T1100-S4Q	1456754	1100	1/4	0.4-4.3	3.5-38	0.9-4.3	7.9-38	0.86	1.89	6.5	13.8	1/8	6	1/4
B	SCP047-T550-S4Q	1456764	550	1/4	0.4-4.7	3.5-41.6	0.9-4.7	7.9-41.6	0.86	1.89	6.5	13.8	1/8	6	1/4
C	SDP035-T2100-S4Q	1465564	2100	1/4	1.0-3.5	8.9-31	1.0-3.5	8.9-31	0.9	1.98	9.0	19.1	1/4	10	3/8
C	SDP055-T1400-S4Q	1465554	1400	1/4	1.0-5.5	8.9-48.7	1.0-5.5	8.9-48.7	1.0	2.20	9.0	19.1	1/4	10	3/8
C	SDP075-T1050-S4Q	1465544	1050	1/4	0.6-7.5	5.3-66.4	2.5-7.5	22.1-66.4	1.0	2.20	9.0	19.1	1/4	10	3/8
C	SDP100-T780-S4Q	1465534	780	1/4	0.6-10	5.3-88.5	3.5-10	31.0-88.5	1.0	2.20	9.0	19.1	1/4	10	3/8
C	SDP140-T490-S4Q	1465524	490	1/4	0.6-14	5.3-124	3.5-10	31.0-88.5	1.0	2.20	9.0	19.1	1/4	10	3/8
C	SDP160-T300-S4Q	1465514	300	1/4	0.6-16	5.3-142	3.5-10	31.0-88.5	1.0	2.20	9.0	19.1	1/4	10	3/8
C	SDP045-T180-S4Q	205 146 706 4	180	1/4	1.5-4.5	13.3-39.8	1.5-4.5	13.3-39.8	1.0	2.20	9.0	19.1	1/4	10	3/8
D	SDT035-T1100-S4Q	205 147 623 4	1100	1/4	1.0-3.5	8.9-31	1.0-3.5	8.9-31	1.0	2.20	9.0	19.1	1/4	10	3/8
D	SDT035-T2200-S4Q	1465774	2200	1/4	1.0-3.5	8.9-31	1.0-3.5	8.9-31	1.1	2.42	9.0	19.1	1/4	10	3/8
D	SDT055-T1470-S4Q	1465764	1470	1/4	2.0-5.5	17.7-48.7	2.0-5.5	17.7-48.7	1.1	2.42	9.0	19.1	1/4	10	3/8
D	SDT075-T1100-S4Q	1465754	1100	1/4	2.5-7.5	22.1-66.4	2.5-7.5	22.1-66.4	1.1	2.42	9.0	19.1	1/4	10	3/8
D	SDT100-T820-S4Q	1465744	820	1/4	3.5-10	31.0-88.5	3.5-10	31.0-88.5	1.1	2.42	9.0	19.1	1/4	10	3/8
D	SDT140-T510-S4Q	1465734	510	1/4	3.5-14	31.0-124	3.5-10	31.0-88.5	1.1	2.42	9.0	19.1	1/4	10	3/8
D	SDT160-T320-S4Q	1465724	320	1/4	3.5-16	31.0-142	3.5-10	31.0-88.5	1.1	2.42	9.0	19.1	1/4	10	3/8

PUSH START, TOP AIR INLET

E	SCPT021-A2300-S4Q	1458974	2300	1/4	0.4-2.1	3.5-18.6	0.4-0.9	3.5-7.9	0.86	1.89	6.5	13.8	1/8	6	1/4
E	SCPT043-A1100-S4Q	1458894	1100	1/4	0.4-4.3	3.5-38	0.9-4.3	7.9-38.0	0.86	1.89	6.5	13.8	1/8	6	1/4
E	SCPT047-A550-S4Q	1458854	550	1/4	0.4-4.7	3.5-41.6	0.9-4.7	7.9-41.6	0.86	1.89	6.5	13.8	1/8	6	1/4

SH range - Angle head - Shut off

2.5 to 200 Nm (22.1 to 1770 in.lb) - 80 to 1100 rpm



PRODUCTIVITY

- High speed with joint stiffness capability

QUALITY

- High accuracy with immediate shut off
- Improve your process quality with FAS3000

ERGONOMY

- Low reaction force on hard joint

DURABILITY

- Low frequency maintenance
- Quick service time



Option:
Reaction bar for SH850/1200/2000

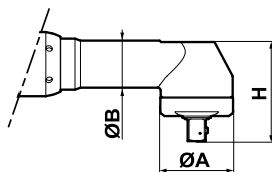

MODEL	ANGLE HEAD DIMENSIONS					
	ØA		ØB		H	
	mm	in.	mm	in.	mm	in.
SH70	20	0.79	20	0.79	36.6	1.44
SH150	22	0.87	21	0.83	35.2	1.38
SH200	27	1.06	27	1.06	45.5	1.79
SH280	27	1.06	24	0.94	41.5	1.63
SH420	40	1.57	29	1.10	56.5	2.20
SH500	40	1.57	29	1.10	56.5	2.20
SH700	40	1.57	29	1.10	56.5	2.20
SH850	51	2.00	33	1.30	69.5	2.70
SH1200	51	2.00	33	1.30	69.5	2.70
SH2000	51	2.00	33	1.30	69.5	2.70



ACCESSORIES
see page 144

PIC REF	MODEL	PART NUMBER	BOLT SIZE	FREE SPEED	SQUARE DRIVE	TORQUE RANGE		LENGTH		WEIGHT		AIR FLOW		AIR INLET		HOSE INT. Ø	
			mm	rpm	in	Nm	in.lb	mm	in.	kg	lb.	l/s	cfm	in.	mm	in.	
A	SH70-LR1100-S90-A4S	205 147 628 4	M5	1100	1/4	2.5-7	22.1-61.9	334	13.1	1.3	2.9	8	17	1/4	8	5/16	
B	SH150-LR580-S90-A10S	205 147 629 4	M6	560	3/8	7-15	61.9-44.2	349	13.7	1.4	3.1	10	21	1/4	10	3/8	
B	SH200-LR550-S90-A10S	205 147 630 4	M6	530	3/8	10-19	88.5-168	355	14.0	1.4	3.1	10	21	1/4	10	3/8	
B	SH280-LR350-S90-A10S	205 147 631 4	M8	340	3/8	14-28	124-248	350	13.8	1.4	3.1	10	21	1/4	10	3/8	
B	SH280-LR80-S90-A10S	205 147 632 4	M8	80	3/8	14-28	124-248	350	13.8	1.4	3.1	10	21	1/4	10	3/8	
C	SH420-LR400-S90-A10S	205 147 800 4	M10	400	3/8	20-42	177-372	436	17.2	2.0	4.4	16	34	1/4	10	3/8	
C	SH500-LR330-S90-A13S	205 147 473 4	M10	330	1/2	25-50	221-442	453	17.8	2.2	4.8	16	34	1/4	10	3/8	
D	SH700-LR225-S90-A13S	205 147 474 4	M10-M12	225	1/2	34-70	301-619	487	19.2	2.4	5.3	16	34	1/4	10	3/8	
D	SH850-LR190-S90-A13S	205 147 475 4	M12	190	1/2	40-85	354-752	530	20.8	2.8	6.1	16	34	1/4	10	3/8	
E	SH1200-LR215-S90-A13S	205 147 476 4	M12-M14	215	1/2	70-120	354-1062	590	23.2	3.5	7.6	28	59	1/2	13	1/2	
E	SH2000-LR100-S90-A13S	205 147 801 4	M12-M14	100	1/2	115-200	1018-1770	608	23.9	4.4	9.7	28	59	1/2	13	1/2	

Angle Head - Shut off

0.4 to 27 Nm (3.5 to 239 in.lb) - 170 to 2200 rpm



ACCESSORIES
see page 144

PIC REF	MODEL	PART NUMBER	FREE SPEED	OUTPUT DRIVE	TORQUE RANGE		FITTED SPRING		LENGTH		WEIGHT		AIR FLOW		AIR INLET	HOSE INT. Ø	
			rpm	in.	Nm	in.lb	Nm	in.lb	mm	in.	kg	lb.	l/s	cfm	in.	mm	in.
TWO WAY																	
A	SC043-L950-S90A4S	1459134	950	1/4 sq	0.4-4.3	3.5-38	0.9-4.3	7.9-38	275	10.8	0.84	1.85	6.5	13.8	1/8	6	1/4
A	SC047-L500-S90A4S	1459124	500	1/4 sq	0.4-4.7	3.5-41.5	0.9-4.7	7.9-41.5	275	10.8	0.84	1.85	6.5	13.8	1/8	6	1/4
B	SC043-L950-S90A4H	1459054	950	1/4 hex	0.4-4.3	3.5-38	0.9-4.3	7.9-38	275	10.8	1.12	2.47	6.5	13.8	1/8	6	1/4
B	SC047-L500-S90A4H	1459044	500	1/4 hex	0.4-4.7	3.5-41.5	0.9-4.7	7.9-41.5	275	10.8	1.12	2.47	6.5	13.8	1/8	6	1/4
C	SD072-LB1080-S90-A10S	1463504	1080	3/8 sq	2.5-7.2	22-63.7	2.5-7.2	22-63.7	353	13.9	1.41	3.11	8.7	18.4	1/4	10	3/8
C	SD095-LB800-S90-A10S	1463494	800	3/8 sq	3-9.5	26.6-84.1	3-9.5	26.6-84.1	353	13.9	1.41	3.11	8.7	18.4	1/4	10	3/8
C	SD130-LB600-S90-A10S	1463484	600	3/8 sq	4.5-12	39.8-106	4.5-12	39.8-106	353	13.9	1.41	3.11	8.7	18.4	1/4	10	3/8
C	SD209-LB370-S90-A10S	1463474	370	3/8 sq	11-19	97.3-168	6-19	53.1-168	376	14.8	1.50	3.31	8.7	18.4	1/4	10	3/8
C	SD300-LB250-S90-A10S	1463464	250	3/8 sq	11-27	97.3-239	11-27	97.3-239	376	14.8	1.50	3.31	8.7	18.4	1/4	10	3/8
C	SD072-LR1080-S90-A10S	1463554	1080	3/8 sq	2.5-7.2	22-63.7	2.5-7.2	22-63.7	376	14.8	1.41	3.11	8.7	18.4	1/4	10	3/8
C	SD095-LR800-S90-A10S	1463544	800	3/8 sq	3-9.5	26.6-84.1	3-9.5	26.6-84.1	376	14.8	1.41	3.11	8.7	18.4	1/4	10	3/8
C	SD130-LR600-S90-A10S	1463534	600	3/8 sq	4.5-12	39.8-106	4.5-12	39.8-106	376	14.8	1.41	3.11	8.7	18.4	1/4	10	3/8
C	SD209-LR370-S90-A10S	1463524	370	3/8 sq	11-19	97.3-168	6-19	53.1-168	376	14.8	1.41	3.11	8.7	18.4	1/4	10	3/8
C	SD300-LR250-S90-A10S	1463514	250	3/8 sq	11-27	97.3-239	11-27	97.3-239	376	14.8	1.50	3.31	8.7	18.4	1/4	10	3/8
C	SD300-LR180-S90-A10S	205 146 704 4	180	3/8 sq	11-27	97.3-239	11-27	97.3-239	375	14.8	1.50	3.30	8.7	18.4	1/4	10	3/8

Screwdrivers - Non Shut off - Push and Lever start

0.6 to 10 Nm (5.3 to 88.5 in.lb) - 510 to 3500 rpm



A



B



C

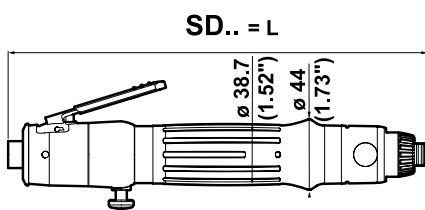

Model	L mm (in.)
SD023..3500	252 (9.92)
SD035..2200	252 (9.92)
SD055..1470	278 (10.9)
SD075..1100	278 (10.9)
SD100..820	278 (10.9)
SD100..510	278 (10.9)



ACCESSORIES
see page 142

PIC REF	MODEL	PART NUMBER	FREE SPEED rpm	OUTPUT HEX in.	TORQUE RANGE		FITTED SPRING		WEIGHT		AIR FLOW		AIR INLET	HOSE INT.Ø	
					Nm	in.lb	Nm	in.lb	kg	lb.	l/s	cfm	in.	mm	in.
PUSH START															
A	SD035-AB2200-R4Q	1462944	2200	1/4	1.0-3.5	8.9-31.0	1.0-3.5	8.9-31.0	0.73	1.61	8.7	18.4	1/4	10	3/8
A	SD055-AB1470-R4Q	1462934	1470	1/4	0.6-5.5	5.3-48.7	2.0-5.5	17.7-48.7	0.89	1.96	8.7	18.4	1/4	10	3/8
A	SD075-AB1100-R4Q	1462924	1100	1/4	0.6-7.5	5.3-66.4	2.5-7.5	22.1-66.4	0.89	1.96	8.7	18.4	1/4	10	3/8
LEVER START															
B	SD055-LB1470-R4Q	1463194	1470	1/4	0.6-5.5	5.3-48.7	2.0-5.5	17.7-48.7	0.92	2.03	8.7	18.4	1/4	10	3/8
B	SD075-LB1100-R4Q	1463184	1100	1/4	0.6-7.5	5.3-66.4	2.5-7.5	22.1-66.4	0.92	2.03	8.7	18.4	1/4	10	3/8
B	SD100-LB820-R4Q	1463174	820	1/4	0.6-10	5.3-88.5	3.5-10	31.0-88.5	0.92	2.03	8.7	18.4	1/4	10	3/8
B	SD100-LB510-R4Q	1463164	510	1/4	0.6-10	5.3-88.5	3.5-10	31.0-88.5	0.92	2.03	8.7	18.4	1/4	10	3/8
C	SD023-LR3500-R4Q	1463154	3500	1/4	1.0-2.3	8.9-20.3	1.0-2.3	8.9-20.3	0.76	1.67	8.7	18.4	1/4	10	3/8

Screwdrivers - Non Shut Off - Pistol Grip

0.4 to 10 Nm (3.5 to 88.5 in.lb) - 300 to 3500 rpm



A



B



C

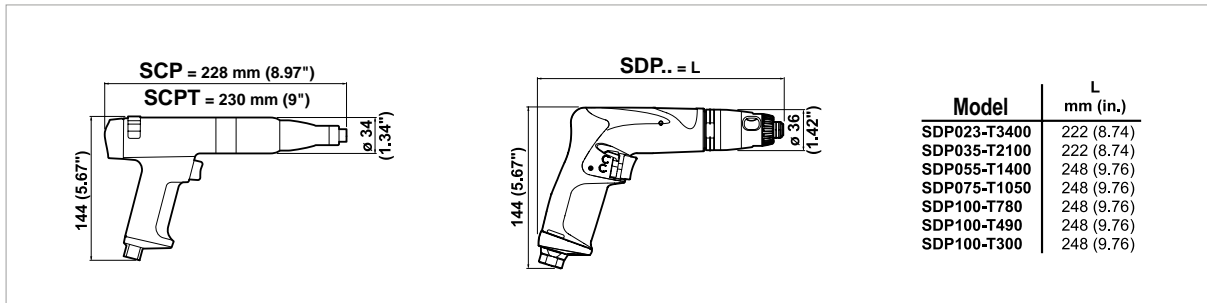

ACCESSORIES
see page 142

PIC REF	MODEL	PART NUMBER	FREE SPEED rpm	OUTPUT HEX in.	TORQUE RANGE		FITTED SPRING		WEIGHT		AIR FLOW		AIR INLET in.	HOSE INT.Ø	
					Nm	in.lb	Nm	in.lb	kg	lb.	l/s	cfm		mm	in.
TRIGGER START															
A	SCP044-T1100-R4Q	1456794	1100	1/4	0.4-4.4	3.5-38.9	1.3-4.4	11.5-38.9	0.86	1.89	6.5	13.8	1/8	6	1/4
A	SCP044-T550-R4Q	1456804	550	1/4	0.4-4.4	3.5-38.9	1.0-4.4	8.9-38.9	0.86	1.89	6.5	13.8	1/8	6	1/4
B	SDP035-T2100-R4Q	1465634	2100	1/4	1.0-3.5	8.8-31.0	1.0-3.5	8.9-31.0	0.90	1.98	9.0	19.1	1/4	10	3/8
B	SDP055-T1400-R4Q	1465624	1400	1/4	1.0-5.5	8.8-48.6	1.0-5.5	8.9-48.6	1.00	2.20	9.0	19.1	1/4	10	3/8
B	SDP075-T1050-R4Q	1465614	1050	1/4	0.6-7.5	5.3-66.3	2.5-7.5	22.1-66.3	1.00	2.20	9.0	19.1	1/4	10	3/8
B	SDP100-T780-R4Q	1465604	780	1/4	0.6-10	5.3-88.5	3.5-10	31.0-88.5	1.00	2.20	9.0	19.1	1/4	10	3/8
B	SDP100-T490-R4Q	1465594	490	1/4	0.6-10	5.3-88.5	3.5-10	31.0-88.5	1.00	2.20	9.0	19.1	1/4	10	3/8
B	SDP100-T300-R4Q	1465584	300	1/4	0.6-10	5.3-88.5	3.5-10	31.0-88.5	1.00	2.20	9.0	19.1	1/4	10	3/8
PUSH START, TOP AIR INLET															
C	SCPT022-A1600-R4Q	1458954	1600	1/4	0.5-2.2	4.4-19.4	0.8-2.2	7.1-19.4	0.86	1.89	6.5	13.8	1/8	6	1/4

Angle Head - Direct drive

1.5 to 105 Nm (13.3 to 929 in.lb) - 60 to 800 rpm

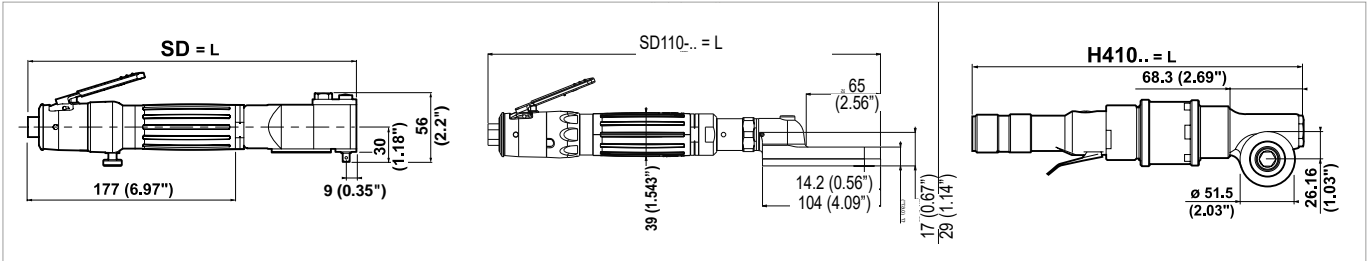

SD - Stall Torque (Nm) Setting using Regulator Part No. 81223



ACCESSORIES
see page 144

MODEL	REGULATOR POSITION						
	1	2	3	4	5	6	OPEN
INLET PRESSURE - 6.3 BAR							
SD130-LB500-D90-A4S	3.2	3.5	5.3	7.0	10.0	12.5	13.0
SD096-LB800-D90-A4S	2.6	2.8	4.0	5.5	7.3	9.0	9.6
INLET PRESSURE - 4.0 BAR							
SD130-LB500-D90-A4S	2.0	2.7	3.0	4.2	6.0	8.2	9.0
SD096-LB800-D90-A4S	1.5	1.7	2.5	3.0	4.5	5.5	6.0

H410 - Stall Torque (Nm) Setting using a Typical Regulator

MODEL	REGULATOR POSITION									
	10 %	20 %	30 %	40 %	50 %	60 %	70 %	80 %	90 %	OPEN
INLET PRESSURE - 6.3 BAR										
H410-N-500	3	6	9	12	15	18	21	24	27	30
H410-N-350	5	9	14	18	23	27	32	36	41	45
H410-N-150	8	16	24	32	40	48	56	64	72	80
H410-N-90	16	32	48	63	79	95	-	-	-	-
H410-N-60	20	40	60	80	-	-	-	-	-	-
INLET PRESSURE - 4.0 BAR										
H410-N-500	2	4	6	8	9	11	13	15	17	19
H410-N-350	3	6	9	11	14	17	20	23	26	28
H410-N-150	5	10	15	20	25	30	35	40	45	50
H410-N-90	10	20	30	40	50	60	70	80	90	100
H410-N-60	4	30	45	60	75	90	105	-	-	-

Maximum stall torque 105Nm

Performance will differ from the figures above depending on the regulator used

Data obtained from a lubricated air line

Torque figures are to be used as a guide only

* Must never be used without regulator with a pressure higher than 4 bars

** Must never be used without regulator with a pressure higher than 2 bars

H410-N – When using direct drive screwdrivers, it is strongly advised to equip the machines with a reaction bar to compensate against potentially high torque reaction and avoid operator injury

PIC REF	MODEL	PART NUMBER	FREE SPEED	OUTPUT DRIVE	TORQUE RANGE		LENGTH L		WEIGHT		AIR FLOW		AIR INLET		HOSE INT. Ø	
					Nm	in.lb	mm	in.	kg	lb.	l/s	cfm	in.	mm	in.	
A	SD130-LB500-D90-A4S	1465974	500	1/4 sq	2-13	17.7-115	326	12.8	1.08	2.38	8.7	18.4	1/4	10	3/8	
B	SD110-LX450	205 148 131 4	450	0.445 hex	1.5-11.8	13.3-104	346	13.6	1.34	2.95	8.5	18.0	1/4	10	1/4	
C	H410-N-500	1302374	500	0.525 hex	3-30	26.6-265	319	12.6	1.70	3.74	17.9	37.9	3/8	12	1/2	
C	H410-N-350	1302454	350	0.525 hex	4.5-45	39.8-398	319	12.6	1.70	3.74	17.9	37.9	3/8	12	1/2	
C	H410-N-150	1302534	150	0.525 hex	8-80	70.8-708	358	14.1	2.00	4.41	17.9	37.9	3/8	12	1/2	
C	H410-N-90*	1302614	90	0.525 hex	10-105	88.5-929	358	14.1	2.00	4.41	13.2	27.9	3/8	12	1/2	
C	H410-N-60**	1302794	60	0.525 hex	10-105	88.5-929	358	14.1	2.00	4.41	13.2	27.9	3/8	12	1/2	

Screwdrivers - Direct drive Pistol grip

1 to 14 Nm (8.9 to 124 in.lb) - 490 to 3400 rpm



A

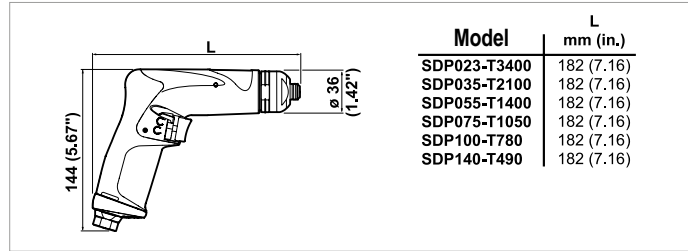

ACCESSORIES
see page 143

PIC REF	MODEL	PART NUMBER	FREE SPEED	OUTPUT HEX	TORQUE RANGE		WEIGHT		AIR FLOW		AIR INLET	HOSE INT. Ø	
					rpm	in.	Nm	in.lb	kg	lb.		l/s	cfm
A	SDP035-T2100-D4Q	1465704	2100	1/4	1.0-3.5	8.9-31.0	0.8	1.76	9.0	19.1	1/4	10	3/8
A	SDP055-T1400-D4Q	1465694	1400	1/4	1.0-5.5	8.9-48.6	0.8	1.76	9.0	19.1	1/4	10	3/8
A	SDP075-T1050-D4Q	1465684	1050	1/4	3.5-7.5	31-66.3	0.8	1.76	9.0	19.1	1/4	10	3/8
A	SDP100-T780-D4Q	1465674	780	1/4	3.5-10	31-88.5	0.8	1.76	9.0	19.1	1/4	10	3/8
A	SDP140-T490-D4Q	1465664	490	1/4	3.5-14	31-124	0.8	1.76	9.0	19.1	1/4	10	3/8

Screwdrivers - Left hand tightening - Shut off Push start Automatic reverse

0.6 to 16 Nm (5.3 to 142 in.lb) - 320 to 1100 rpm



A

Tool shown with optional clutch HSG and bit adaptor

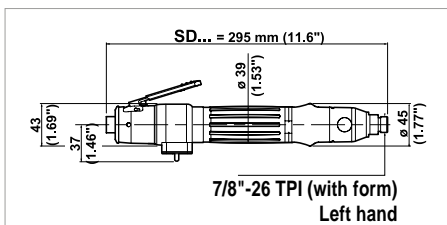

APPLICATIONS

Placement of Threaded Fasteners

Tapping in Blind Holes

Clearing Tapped Holes after Painting or Coating



ACCESSORIES
see page 142

PIC REF	MODEL	PART NUMBER	FREE SPEED	OUTPUT HEX	TORQUE RANGE		FITTED SPRING		WEIGHT		AIR FLOW		AIR INLET	HOSE INT. Ø	
					rpm	in.	Nm	in.lb	Nm	in.lb	kg	lb.		l/s	cfm
AUTOMATIC REVERSE															
A	SD140-LA510-S4	1464584	510	See	0.6-14	5.3-124	-	-	1.0	2.2	8.7	18.4	1/4	10	3/8
A	SD075-LA1100-S4	1464604	1100	Accessories	0.6-7.5	5.3-66.4	-	-	1.0	2.2	8.7	18.4	1/4	10	3/8

Torque Controlled - Shut Off

0.5 to 16 Nm (4.4 to 142 in.lb) - 320 to 3500 rpm



Signal

M5 Port provides signal while tool is running
The signal stops when the clutch operates

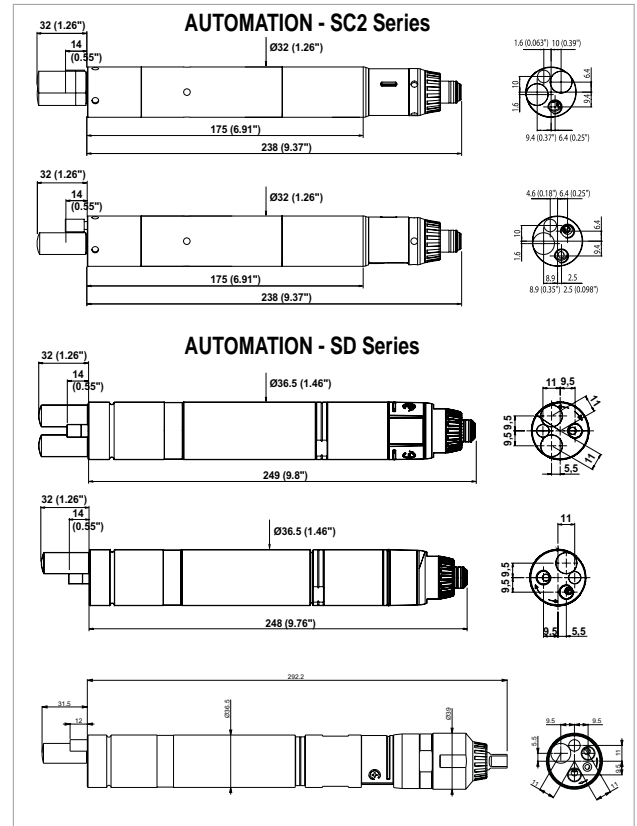

ACCESSORIES
see page 145

PIC REF	MODEL	PART NUMBER	FREE SPEED	OUTPUT DRIVE	TORQUE RANGE		FITTED SPRING		WEIGHT		AIR FLOW		AIR INLET		HOSE INT. Ø	
					Nm	in.lb	Nm	in.lb	kg	lb.	l/s	cfm	in.	mm	in.	
AUTOMATION - PUSH START - SHUT OFF - 1 WAY																
A	SC2-025-1AM2200-S4Q	205 147 426 4	2150	1/4 Hex	0.5-2.5	4.4-22	0.5-2.5	4.4-22.1	0.64	1.41	7	14.8	1/8	6	1/4	
A	SC2-035-1AM1500-S4Q	205 147 425 4	1450	1/4 Hex	0.5-3.5	4.4-30.8	1.7-3.5	15-30.9	0.64	1.41	7	14.8	1/8	6	1/4	
A	SC2-045-1AM1000-S4Q	205 147 424 4	1000	1/4 Hex	0.5-4.5	4.4-39.6	1.7-4.5	15-39.8	0.64	1.41	7	14.8	1/8	6	1/4	
A	SC2-055-1AM700-S4Q	205 147 423 4	670	1/4 Hex	0.5-5.5	4.4-48.4	3-5.5	26.5-48.6	0.64	1.41	7	14.8	1/8	6	1/4	
A	SC2-065-1AM500-S4Q	205 147 422 4	470	1/4 Hex	0.5-6.5	4.4-57.2	3-6.5	26.5-57.5	0.64	1.41	7	14.8	1/8	6	1/4	
AUTOMATION - REMOTE START - SHUT OFF - 2 WAY																
B	SC2-025-2RM2200-S4Q	205 147 440 4	2150	1/4 Hex	0.5-2.5	4.4-22	0.5-2.5	4.4-22.1	0.64	1.41	7	14.8	1/8	6	1/4	
B	SC2-035-2RM1500-S4Q	205 147 439 4	1450	1/4 Hex	0.5-3.5	4.4-30.8	1.7-3.5	15-30.9	0.64	1.41	7	14.8	1/8	6	1/4	
B	SC2-045-2RM1000-S4Q	205 147 438 4	1000	1/4 Hex	0.5-4.5	4.4-39.6	1.7-4.5	15-39.8	0.64	1.41	7	14.8	1/8	6	1/4	
B	SC2-055-2RM700-S4Q	205 147 437 4	670	1/4 Hex	0.5-5.5	4.4-48.4	3-5.5	26.5-48.6	0.64	1.41	7	14.8	1/8	6	1/4	
B	SC2-065-2RM500-S4Q	205 147 436 4	470	1/4 Hex	0.5-6.5	4.4-57.2	3-6.5	26.5-57.5	0.64	1.41	7	14.8	1/8	6	1/4	
AUTOMATION - PUSH START - SHUT OFF - 1 WAY																
C	SD035-1AM2200-S4Q	1464244	2200	1/4 Hex	1.0-3.5	8.8-31	1.0-3.5	8.8-30.9	0.92	2.03	8.7	18.4	1/8	10	3/8	
C	SD055-1AM1470-S4Q	1464234	1470	1/4 Hex	2.0-5.5	18-48.7	2.0-5.5	18-48.7	0.92	2.03	8.7	18.4	1/8	10	3/8	
C	SD075-1AM1100-S4Q	1464224	1100	1/4 Hex	2.5-7.5	22-66.4	2.5-7.5	22-66.4	0.92	2.03	8.7	18.4	1/8	10	3/8	
C	SD100-1AM820-S4Q	1464214	820	1/4 Hex	3.5-10	31-88.5	3.5-10	31-88.5	0.92	2.03	8.7	18.4	1/8	10	3/8	
C	SD140-1AM510-S4Q	1464204	510	1/4 Hex	3.5-14	31-124	3.5-10	31-88.5	0.92	2.03	8.7	18.4	1/8	10	3/8	
C	SD160-1AM320-S4Q	1464194	320	1/4 Hex	3.5-16	31-142	3.5-10	31-88.5	0.92	2.03	8.7	18.4	1/8	10	3/8	
AUTOMATION - REMOTE START - SHUT OFF - 2 WAY																
D	SD035-2RM2200-S4Q	1464314	2200	1/4 Hex	1.0-3.5	8.8-31	1.0-3.5	8.8-30.9	0.92	2.03	8.7	18.4	1/8	10	3/8	
D	SD055-2RM1470-S4Q	1464304	1470	1/4 Hex	2.0-5.5	18-48.7	2.0-5.5	18-48.7	0.92	2.03	8.7	18.4	1/8	10	3/8	
D	SD075-2RM1100-S4Q	1464294	1100	1/4 Hex	2.5-7.5	22-66.4	2.5-7.5	22-66.4	0.92	2.03	8.7	18.4	1/8	10	3/8	
D	SD100-2RM820-S4Q	1464284	820	1/4 Hex	3.5-10	31-88.5	3.5-10	31-88.5	0.92	2.03	8.7	18.4	1/8	10	3/8	
D	SD140-2RM510-S4Q	1464274	510	1/4 Hex	3.5-14	31-124	3.5-10	31-88.5	0.92	2.03	8.7	18.4	1/8	10	3/8	
D	SD160-2RM320-S4Q	1464264	320	1/4 Hex	3.5-16	31-142	3.5-10	31-88.5	0.92	2.03	8.7	18.4	1/8	10	3/8	
E	SD220-2RM320-S4Q	205 147 939 4	320	1/4 Hex	9-16	27-142	9-16	27-142	1.4	3.1	8.7	18.4	10	3/8		
E	SD220-2RM320-S10S	205 147 941 4	320	3/8 Sq	9-22	27-198	9-19	27-168	1.4	3.1	8.7	18.4	10	3/8		

Accessories

STRAIGHT - PUSH START & LEVER START

ACCESSORIES INCLUDED

ITEM	SB	SC2	SD
• Suspension bail(s)	443703	205 049 537 3	467003
• Suspension bail internal		205 051 289 3	
• Exhaust hose	443723	205 049 584 3	467073
• Clutch adjustment keys	446583	205 050 785 3	29932
1 Short lever (lever start model)		205 052 020 3	
2 Rings identification		205 049 590 3	
3 Side handle assembly			467033

OPTIONAL ACCESSORIES

ITEM	SB	SC2	SD
3 Side handle assembly		205 052 175 3	
• Double-ended bit holder		205 052 883 3	465523

Balancers & Tool Holster

4 Spring suspension balancer	50522	50522	52862
5 Hose reel balancer	50552	50552	50562
6 Tool holster DTH-42	107892	107892	107892

Bench Stands (for more information, see pages 153-163)

7 D53-25 Linear arm (tool clamp included)	615 810 702 0	615 810 702 0	615 810 702 0
7 D53-25X Linear arm (tool clamp included)	615 810 703 0	615 810 703 0	615 810 703 0
8 D53-25S Folder arm (tool clamp included)	615 810 708 0	615 810 708 0	615 810 708 0
9 D57 Balancing arm	408903	408903	408903
• Tool clamp	615 396 614 0	615 396 614 0	615 396 614 0
9 D57X Balancing arm	408913	408913	408913
• Tool clamp	615 396 614 0	615 396 614 0	615 396 614 0
10 D58 Balancing arm	408923	408923	408923
• Tool clamp	615 396 614 0	615 396 614 0	615 396 614 0

11 TRA12 / TRA25 Telescopic reaction arm

(see page 156)

12 TT10 / TT25 Torque Tube Arm

(see page 159)

Vacuum Pick Up - Order Pick Up kit, Finder Sleeve & Vacuum Source

13 Vacuum pick up kit (spring only for 2A89)	108892		108892
14 Finder sleeve blank - plastic	464093		464093
• Finder sleeve blank - steel	464103		464103
15 Vacuum source AV201 for use with filter/regulator unit			112063

Miscellaneous

16 Offset exhaust			205 047 623 3
• Clutch case 7/8" LH thread 320-1470 rpm			205 047 478 3
• Clutch case 7/8" LH thread 2200-3500 rpm			205 047 479 3
• Clutch case without thrust bump, M20x1.0LH thread 320-1470 rpm			465463
• Clutch case without thrust bump, M20x1.0LH thread 2200-3500 rpm			465443

PISTOL GRIP

ACCESSORIES INCLUDED

	SCBP	SBP	SCP SCPT	SDP SDT
• Suspension bail(s)	307683	307683	307683	473153
• Side handle (320 & 1470 rpm)				467033
• Clutch adjustment keys (320 - 1470 rpm)	205 047 988 3	446583	29932	29932
• Clutch adjustment keys (2200 - 3500 rpm)				467293

OPTIONAL ACCESSORIES

ITEM	SBP SCBP	SCP SCPT	SDP SDT
------	-------------	-------------	------------

Balancers & Holster

1 Spring suspension balancer	52862	52862	52862
2 Hose reel balancer	50552	50552	50562
• Hose reel balancer conversion kit	107403	107403	115193
3 Tool holster DTH-90	615 812 119 0	615 812 119 0	615 812 119 0

Bench Stands (for more information, see pages 172-173)

4 D59 Pantographic arm	408933	408933	408933
------------------------	--------	--------	--------

Miscellaneous

5 Side handle	70442	70442	467033
---------------	-------	-------	--------



Accessories

DIRECT DRIVE

ACCESSORIES INCLUDED

	SDP	SD	H410
• Suspension bail(s)	473153	467003	
• Side handle	467033		
• Exhaust hose		467073	

OPTIONAL ACCESSORIES

ITEM	SDP	SD	H410
• Air flow regulator	81223	81223	

Balancers & Holster

1	Spring suspension balancer	52862	50532	50542
2	Hose reel balancer	50562	50562	
3	Tool holster DTH-42	107892		
4	Tool holster DTH-90		615 812 119 0	

Suspension Shackle

5	Suspension shackle		70082	615 571 050 0
•	Swivel suspension shackle			615 396 229 0

Bench Stands (for more information, see pages 172-173)

6	D59 Pantographic arm	408933		
---	----------------------	--------	--	--

Miscellaneous

7	Side handle	467033		
•	Offset exhaust		205 047 623 3	
•	Square drive adaptor 3/8" Square drive, 48mm (1.89") long			14422
•	Square drive adaptor 1/2" Square drive, 46mm (1.81") long			14442
•	Square drive adaptor 1/2" Square drive, 76mm (2.99") long			14482
•	Exhaust collector			72163

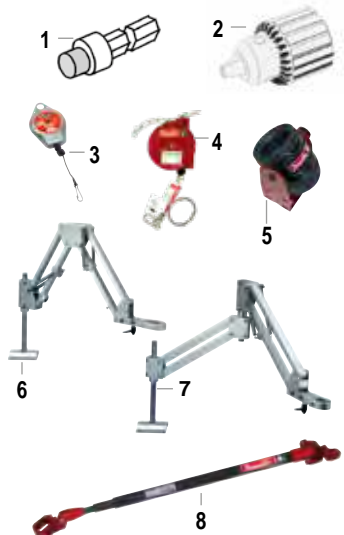
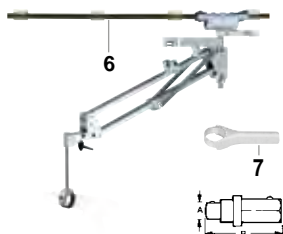

AUTO REVERSE

ACCESSORIES INCLUDED

	SD
• Suspension bail(s)	467003
• Side handle	467033
• Clutch adjustment keys	29932

OPTIONAL ACCESSORIES

ITEM	SD
------	----

Blind Hole Tapping/ Cleaning - 3 parts Required

•	Bit adaptor*	465513
1	Thread adaptor	96743
2	Chuck capacity 8mm (5/16")	205 053 013 3

Balancers & Tool Holster

3	Spring suspension balancer	50532
4	Reaction free self-lock balancer	615 813 078 0
5	Tool holster DTH-42	107892

Bench Stands (for more information, see pages 172-173)

6	D57 Balancing arm	408903
•	Tool clamp	615 396 614 0
6	D57X Balancing arm	408913
•	Tool clamp	615 396 614 0
7	D58 Balancing arm	408923
•	Tool clamp	615 396 614 0
8	TRA25 Telescopic reaction arm	(see page 178)

* To order more clutch cover PN 465453 + washer PN 467113

Accessories

ANGLE HEAD

ACCESSORIES INCLUDED

	SC	SD	SH
• Suspension bail(s)	39433/280893	467003	
• Exhaust hose	396553	467073	
• Adjustment keys	29932	29932	205 050 785 3
• Air hose nipple			205 051 239 3

OPTIONAL ACCESSORIES

ITEM	2D4872	SC	SD	SH
• Exhaust hose for SH70/150/200/280/420/500/700/850				459813
• Exhaust hose for SH1200/2000				205 050 181 3

Balancers & Holster

1 Spring suspension balancer	50532	52862	50532	
1 Spring suspension balancer for SH70/150/200/280				52862
2 Spring suspension balancer for SH420 to SH2000				50052
3 Hose reel balancer	50562	50552	50562	
3 Hose reel balancer for SH70/150/200/280				50562

Suspension Shackle

• Suspension shackle	95842	70082		
----------------------	-------	-------	--	--

Suspension bails

4 Suspension bail for SH70/150/200/280				205 051 632 3
4 Suspension bail for SH420/500/700/850				205 051 113 3
4 Suspension bail for SH1200/2000				615 396 562 0

Swiveling bails

5 Swiveling bail for SH420/500/750/850				205 051 115 3
5 Swiveling bail for SH1200/2000				205 051 232 3

Bench Stands (for more information, see pages 153-163)

6 D53-25 Linear arm (tool clamp included)	615 810 702 0	615 810 702 0	615 810 702 0	615 810 704 0
6 D53-25X Linear arm, extended reach	615 810 703 0	615 810 703 0	615 810 703 0	
7 D53-25S Folder arm (tool clamp included)	615 810 707 0	615 810 707 0	615 810 707 0	615 810 709 0

Bench Stands (for more information, see pages 172-173)

8 D57 Balancing arm	408903	408903	408903	
• Tool clamp	615 396 614 0	615 396 614 0	615 396 614 0	
8 D57X Balancing arm	408913	408913	408913	
• Tool clamp	615 396 614 0	615 396 614 0	615 396 614 0	
9 D58 Balancing arm	408923	408923	408923	
• Tool clamp	615 396 614 0	615 396 614 0	615 396 614 0	
10 TRA12 / TRA25 Telescopic reaction arm		(see page 156)		
11 TT10 / TT25 Torque Tube Arm		(see page 159)		

Miscellaneous

• Offset exhaust				205 047 623 3
12 Protective cover for SH70/150/200/280				205 011 426 2
12 Protective cover for SH420/500				205 050 182 3
12 Protective cover for SH700/850				205 050 235 3
12 Protective cover for SH1200/2000				205 050 252 3
13 Complete reaction bar kit for SH850/1200/2000				205 051 121 3
14 Reporting kit for SH70 (for connexion with FAS)				205 011 424 2
14 Reporting kit for SH150/200/280 (for connexion with FAS)				205 011 425 2
14 Reporting kit for SH420/500/700/850 (for connexion with FAS)				205 050 175 3
14 Reporting kit for SH1200/2000 (for connexion with FAS)				205 050 176 3

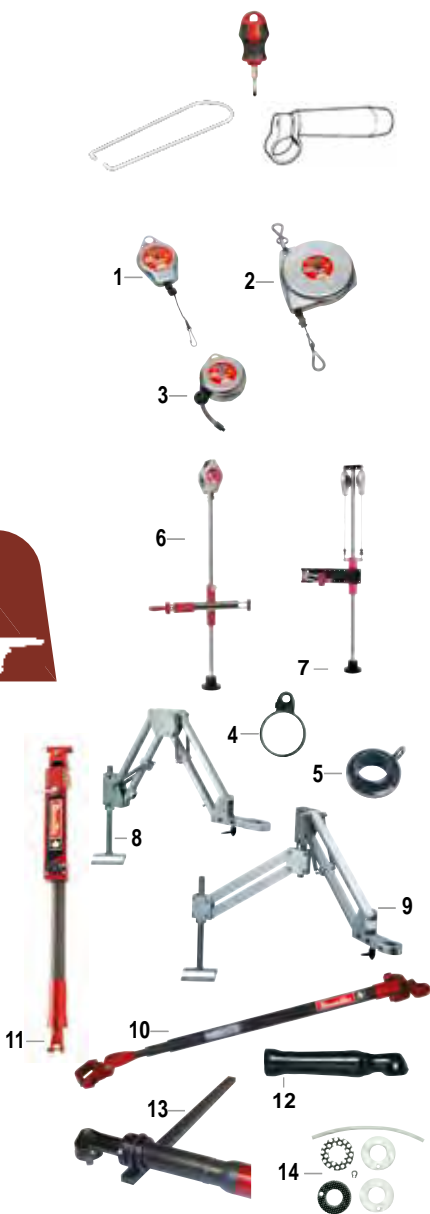

Accessories

TORQUE CONTROLLED

ACCESSORIES INCLUDED

ITEM		SC2 / SD
1	Muffler	205 045 792 3
2	Straight fitting	205 044 497 3



OPTIONAL ACCESSORIES

ITEM		PART NO.
• Spring Loaded Shats and Bearings Support (including 3, 4, 5)		
3	Bit Adaptor	103782
4	Spring Loaded Shatf 25mm (1")	108342
5	Shaft Support and Nose Mount	108412
6	Nose Mounts	205 052 876 3
7	Flange M20	205 052 875 3
• Offset Head & Spring Loaded shaft (Including 8, 9)		
8	Offset Head , offset 30mm (1.18")	384993
9	Spring Loaded Shaft 25mm (1") stroke	108342
10	3/8" Square to 1/4" Hex Power Adaptor	108322

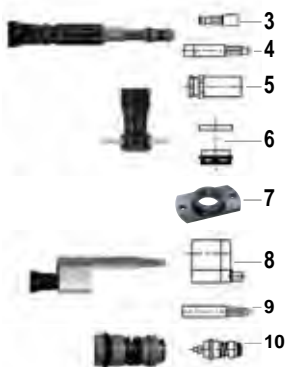

Pulse Tools - Non Shut off and Shut Off range

5 to 172 Nm (3.6 to 127 ft.lb) - 3400 to 6700 rpm

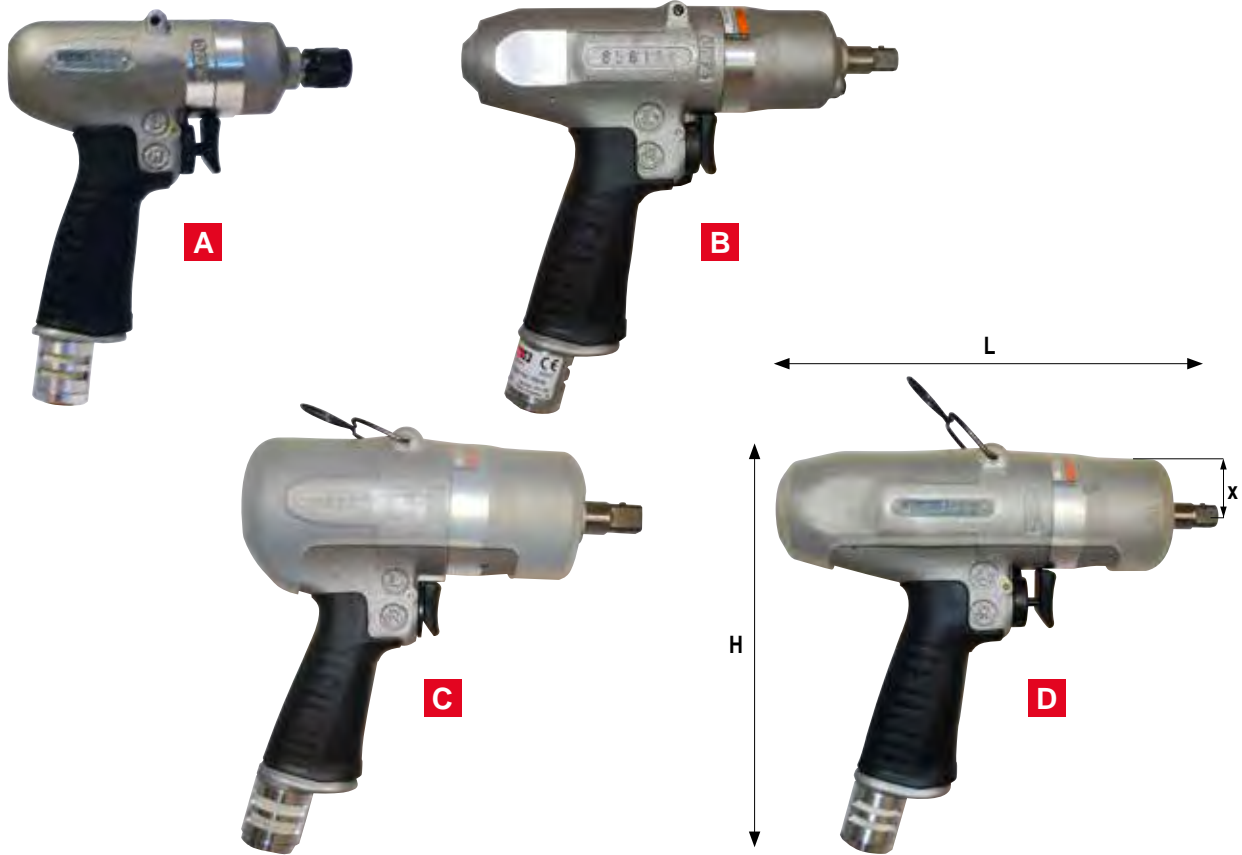

Air inlet: All models 1/4" R

PIC REF	MODEL	PART NUMBER	FREE SPEED	OUTPUT DRIVE	TORQUE RANGE		DIMENSIONS						WEIGHT		AIR FLOW		HOSE INT. Ø	
							L	X	H	kg	lb	l/s	cfm	mm	in.			

NON SHUT OFF

A	PTF020-T6700-I4Q	615 172 101 0	6700	1/4 Hex	9-20	6.6-14.7	140	5.5	22	0.87	169	6.6	0.80	1.7	6.0	12.7	6	1/4
A	PTF028-T6300-I4Q	615 172 102 0	6300	1/4 Hex	16-28	11.8-20.7	140	5.5	22	0.87	169	6.6	0.80	1.7	6.7	14.1	6	1/4
A	PTF035-T6700-I4Q	615 172 103 0	6700	1/4 Hex	20-35	14.7-25.8	152	6.0	22	0.87	169	6.6	0.80	1.7	7.0	14.8	10	3/8
B	PTF024-T6700-I10S	615 172 072 0	6700	3/8 Sq	16-24	11.8-17.7	139.5	5.5	22	0.87	165.7	6.5	0.79	1.7	6.0	12.7	6	1/4
B	PTF040-T6300-I10S	615 172 074 0	6300	3/8 Sq	20-40	14.7-29.5	139.5	5.5	22	0.87	165.7	6.5	0.79	1.7	6.7	14.2	10	3/8
B	PTF056-T6700-I10S	615 172 075 0	6700	3/8 Sq	28-56	20.7-41.3	151.5	5.9	22	0.87	165.7	6.5	0.83	1.8	7.0	14.8	10	3/8
B	PTF060-T6100-I10S	615 172 076 0	6100	3/8 Sq	36-60	26.5-44.2	155	6.1	24	0.94	170.0	6.7	1.02	2.2	10.0	21.2	10	3/8
B	PTF096-T4600-I13S	615 172 077 0	4600	1/2 Sq	52-96	38.3-70.8	173	6.8	27	1.06	175.0	6.9	1.45	3.2	10.8	22.9	10	3/8
B	PTF136-T5000-I13S	615 172 078 0	5000	1/2 Sq	80-136	59-100	182.5	7.2	29.5	1.16	186.5	7.3	1.80	4.0	13.3	28.2	10	3/8
B	PTF172-T3800-I13S	615 172 079 0	3800	1/2 Sq	120-172	88-127	191.5	7.6	32	1.26	192.0	7.6	2.10	4.6	14.2	30.1	10	3/8

SHUT OFF

A	PTF012-T6200-S4Q	615 172 104 0	6200	1/4 Hex	5-12	3.6-8.8	181	7.1	22	0.87	169	6.6	1.00	2.2	6.7	14.1	6	1/4
A	PTF022-T6500-S4Q	615 172 105 0	6500	1/4 Hex	11-22	8.1-16.2	181	7.1	22	0.87	169	6.6	1.00	2.2	7.5	15.9	6	1/4
A	PTF028-T6300-S4Q	615 172 106 0	6300	1/4 Hex	19-28	14.0-20.5	193	7.6	22	0.87	169	6.6	1.00	2.2	9.2	19.4	10	3/8
C	PTF012-T6200-S10S	615 172 081 0	6200	3/8 Sq	5-12	3.7-8.8	180.5	5.5	22	0.87	164.3	6.5	0.97	2.1	6.7	14.1	6	1/4
C	PTF024-T6500-S10S	615 172 084 0	6500	3/8 Sq	11-24	8.1-17.7	180.5	5.5	22	0.87	164.3	6.5	0.97	2.1	7.5	15.9	10	3/8
C	PTF035-T6300-S10S	615 172 087 0	6300	3/8 Sq	22-35	16.2-25.8	192.5	5.9	22	0.87	164.3	6.5	1.00	2.2	9.2	19.4	10	3/8
D	PTF060-T6100-S10S	615 172 088 0	6100	3/8 Sq	30-55	22.1-40.6	189.5	6.1	24	0.94	169.0	6.7	1.10	2.4	10	21.1	10	3/8
D	PTF085-T4800-S13S	615 172 089 0	4800	1/2 Sq	50-85	36.9-62.7	208.5	6.8	27	1.06	175.0	6.9	1.60	3.5	11.3	24.0	10	3/8
D	PTF130-T4500-S13S	615 172 090 0	4500	1/2 Sq	70-120	51.6-88.5	217.5	7.2	29.5	1.16	186.5	7.3	1.85	4.1	13.3	18.2	10	3/8
D	PTF165-T3400-S13S	615 172 091 0	3400	1/2 Sq	110-155	81-114	227.5	7.6	32	1.26	192.0	7.6	2.10	4.6	14.2	30.0	10	3/8

The tool is designed for a working pressure of 6.3 bar 90 PSI.

Pulse Tools - Tool Selection

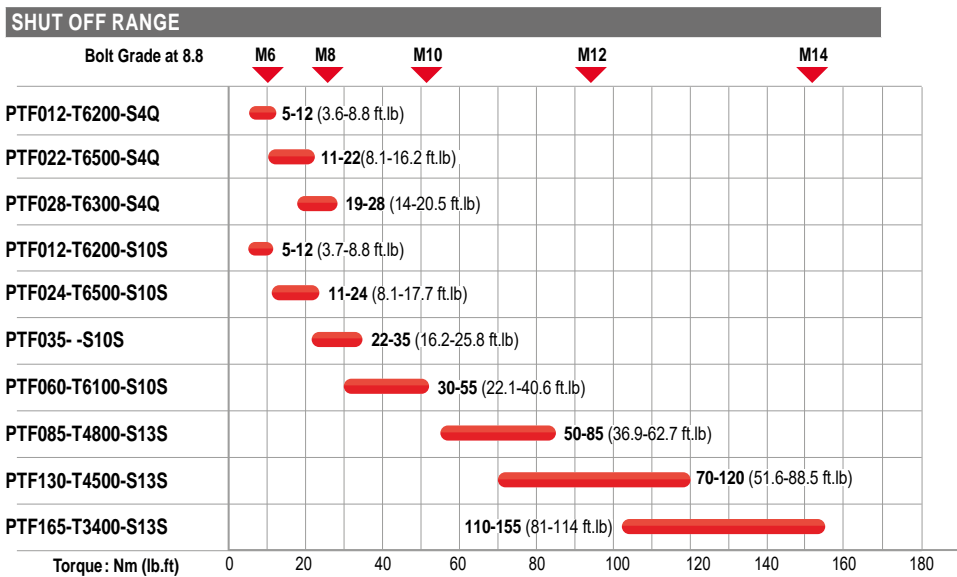
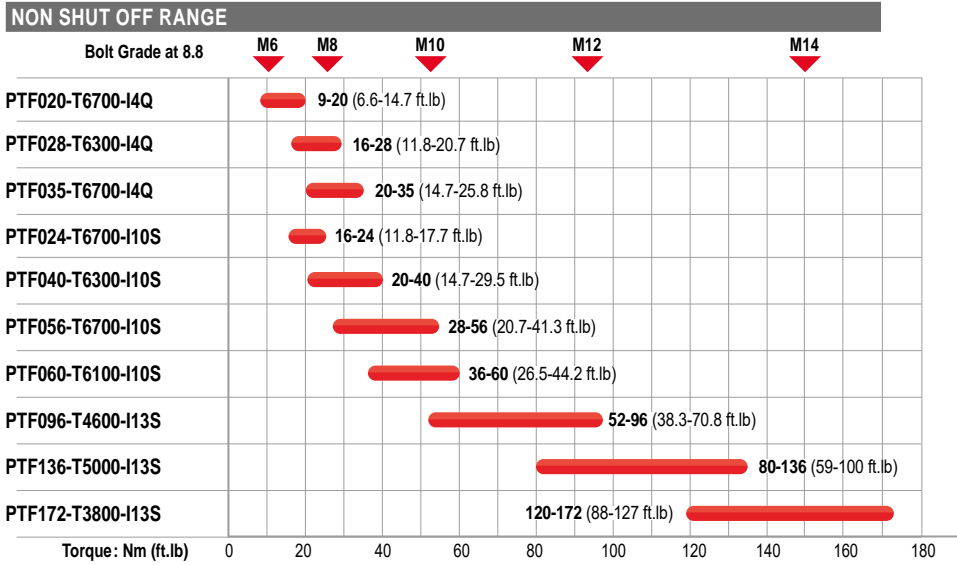

Accessories

ACCESSORIES INCLUDED

	PART NO.
• Air Hose nipple PTF012/024/040	541 205 445 0
• Air Hose nipple (other models)	541 205 445 2
• Suspension bail	541 205 847 4
• Hex pin wrench	-

Pulse Non Shut Off

• Cover protection for PTF020/024/028/040.	541 206 045 6
• Cover protection for PTF060..	541 206 045 8
• Cover protection for PTF056/035.	541 206 045 7
• Cover protection for PTF096..	541 206 045 9
• Cover protection for PTF136..	541 206 046 0
• Cover protection for PTF172..	541 206 046 1

ACCESSORIES INCLUDED

	PART NO.
Pulse Shut Off	
• Cover protection for PTF012/022/024...	541 206 045 0
• Cover protection for PTF035...	541 206 045 1
• Cover protection for PTF060...	541 206 045 2
• Cover protection for PTF085...	541 206 045 3
• Cover protection for PTF130...	541 206 045 4
• Cover protection for PTF165...	541 206 045 5



Specific Nutrunners and Spindles



Specific nutrunners

- Flush socket
- Crowfoot (open or close ended)
- Hold and Drive
- Crowfoot Hold and Drive
- Insulated
- 2 output shafts
- With multiplier
- Quick Change

Specific spindles

- U-Shape
- Specific output shaft
- Second torque transducer

Specific reaction bars

AND MUCH MORE ON REQUEST!

For further information about technical data, please contact your Desoutter representative or Project Manager for assistance

Insulated Solutions

Assembly solutions for electric vehicles

DESOUTTER SOLUTION



During the **assembly of components exposed to high voltage such as busbars and harnesses**, using insulated tools is one of the many important steps to protect from electrical shocks and damages:

- the operators
- the tools
- the battery pack
- the assembly line

The design strictly follows the requirements of the latest International Electro technical Commission (IEC) Norms **IEC60900:2018 & IEC60664-1:2020** that entails to ensure operators are protected against electrical breakdown for currents less than 1000V/AC and 1500V/DC.

Our solution is tested by an external laboratory.

INSULATED TOOLS

1000V RATED

We are allowed to apply the official international 1000-volt rating symbol on the different accessories which are related to the electrical insulation of our tools. This means they prevent electrical breakdown for currents up to 1000 V/AC and 1500 V/DC.

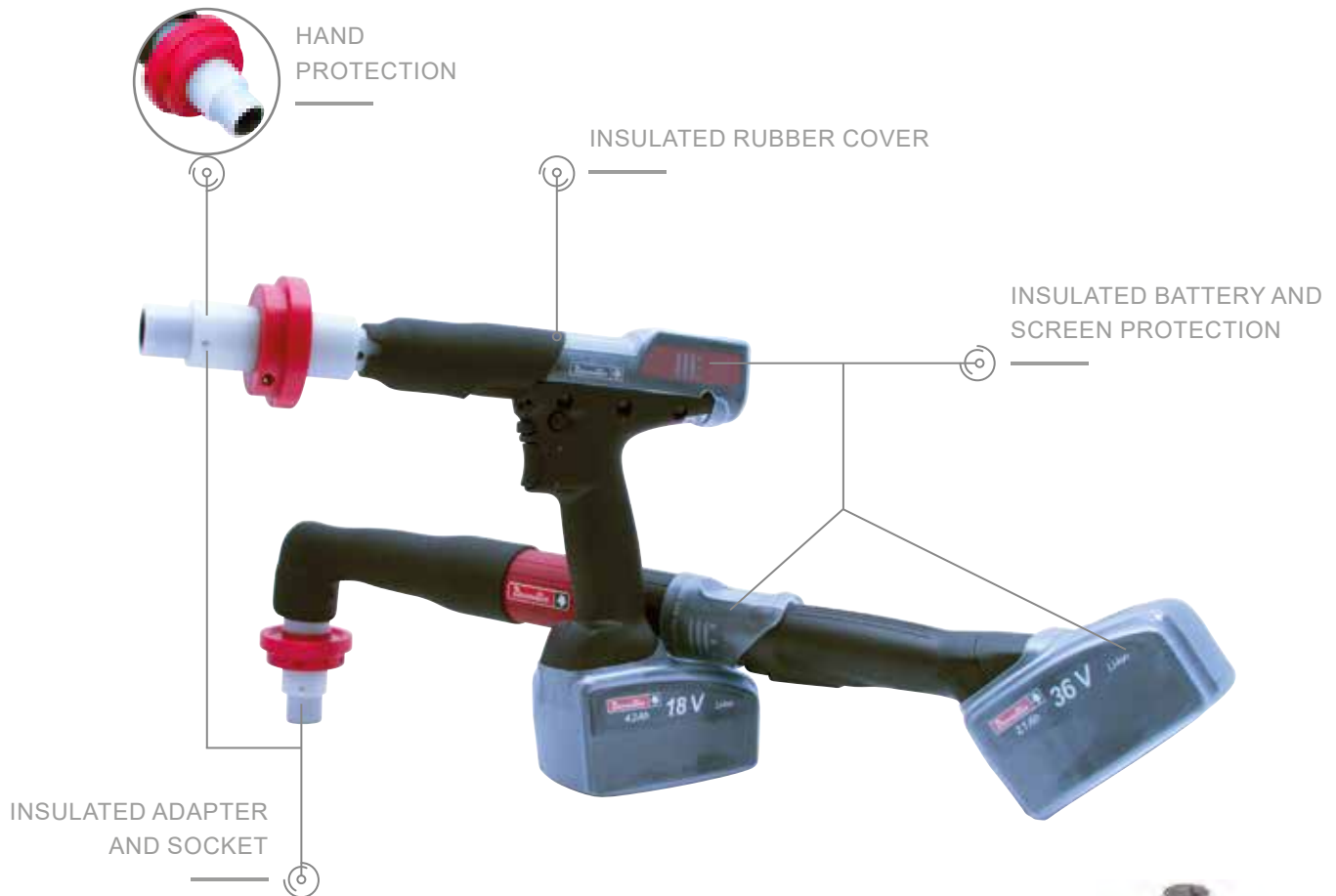

ADAPTER IS BOTH AXIALLY AND RADIALLY INSULATED
→ NO ELECTRICAL CONTINUITY



Insulated Solutions

Assembly solutions for electric vehicles

INSULATED TOOLS AND RANGE

• EABCom and B-Flex Series
5 to 50 Nm (3.7 to 37 ft.lb) - 10 to 900 rpm



• EPBCom and B-Flex Series
1.5 to 17 Nm (1.1 to 12.5 ft.lb) - 10 to 1800 rpm



• EABS Series
1.5 to 24 Nm (1.1 to 17.7 ft.lb) - 10 to 1500 rpm



• E-LIT Series
1.5 to 45 Nm (13.3 to 398 in.lb) - 50 to 880 rpm



EABCom eLink and EPBCom are **compatible** with



For further information,
please contact your Desoutter
representative for assistance.

EPBx High Torque Series

50 to 2000 Nm (36.9 to 1475.1 ft. lb) - 3.2 to 78 rpm

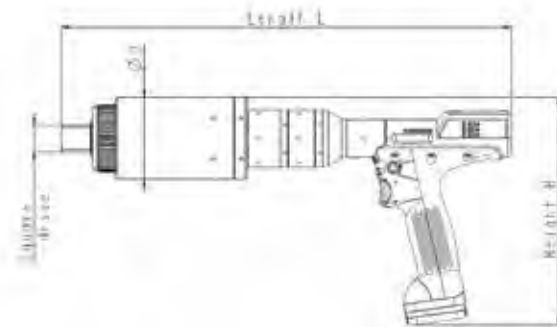

MODEL	Ø D		LENGTH L		HEIGHT H	
	mm	in.	mm	in.	mm	in.
A	48	1.9	290	11.4	206	8.1
B	48	1.9	311	12.2	206	8.1
C	48	1.9	311	12.2	206	8.1
D	63.5	2.5	426	16.8	211.5	8.3
E	83.5	3.3	460	18.1	211.5	8.3
F	80	3.1	433	17	219.5	8.6

PIC REF	MODEL	PART NUMBER	SQUARE DRIVE	TORQUE RANGE				ROTATIONAL SPEED	WEIGHT WITHOUT BATTERY		VOLTAGE
				MIN.	MAX.	MIN.	MAX.		kg	lb	
			in.	Nm	Nm	ft. lb	ft. lb	rpm			V
PISTOL VERSION 150 NM											
A	EPBHT 150-78	STM3996000	1/2	50	150	36.9	110.6	78	1.8	3.9	36
A	EPBAHT 150-78	STM4001000	1/2	50	150	36.9	110.6	78	1.8	3.9	36
A	EPBCHT 150-78	STM4006000	1/2	50	150	36.9	110.6	78	1.8	3.9	36
PISTOL VERSION 300 NM											
B	EPBHT 300-20	STM3997000	3/4	125	300	92.2	221.2	20	2	4.4	36
B	EPBAHT 300-20	STM4002000	3/4	125	300	92.2	221.2	20	2	4.4	36
B	EPBCHT 300-20	STM4007000	3/4	125	300	92.2	221.2	20	2	4.4	36
PISTOL VERSION 500 NM											
C	EPBHT 500-10	STM3998000	3/4	300	500	239.7	368.8	10	2	4.4	36
C	EPBAHT 500-10	STM4003000	3/4	300	500	239.7	368.8	10	2	4.4	36
C	EPBCHT 500-10	STM4008000	3/4	300	500	239.7	368.8	10	2	4.4	36
PISTOL VERSION 1000 NM											
D	EPBHT 1000-6	STM4146000	1	500	1000	405.6	737.5	6	4.3	9.4	36
D	EPBAHT 1000-6	STM4149000	1	500	1000	405.6	737.5	6	4.3	9.4	36
D	EPBCHT 1000-6	STM4033000	1	500	1000	405.6	737.5	6	4.3	9.4	36
PISTOL VERSION 1500 NM											
E	EPBHT 1500-4	STM4147000	1	950	1500	700.7	1106.3	4	6.6	14.5	36
E	EPBAHT 1500-4	STM4150000	1	950	1500	700.7	1106.3	4	6.6	14.5	36
E	EPBCHT 1500-4	STM4034000	1	950	1500	700.7	1106.3	4	6.6	14.5	36
PISTOL VERSION 2000 NM											
F	EPBHT 2000-3	STM4148000	1	1350	2000	995.7	1475.1	3.2	6.1	13.4	36
F	EPBAHT 2000-3	STM4151000	1	1350	2000	995.7	1475.1	3.2	6.1	13.4	36
F	EPBCHT 2000-3	STM4035000	1	1350	2000	995.7	1475.1	3.2	6.1	13.4	36

* Battery not included in standard offering

EABx High Torque Series

250 to 1500 Nm (184.4 to 1106.3 ft. lb) - 4 to 10 rpm

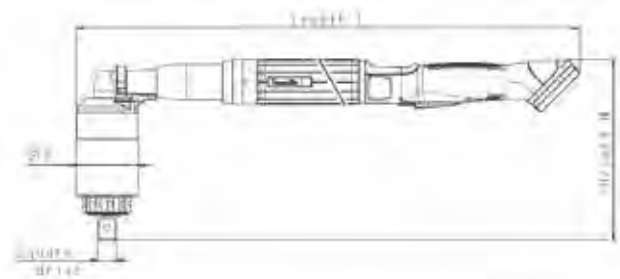

MODEL	Ø D		LENGHT L		HEIGHT H	
	mm	in.	mm	in.	mm	in.
A	48	1.9	482	19	137	5.4
B	63.5	2.5	512	20.1	183	7.2
C	83.5	3.3	529	20.8	298	11.7

PIC REF	MODEL	PART NUMBER	SQUARE DRIVE	TORQUE RANGE				ROTATIONAL SPEED	WEIGHT WITHOUT BATTERY		VOLTAGE
				MIN.	MAX.	MIN.	MAX.		kg	lb	
			in.	Nm	Nm	ft. lb	ft. lb	rpm			V
ANGLE VERSION 500 NM											
A	EABHT 500-10	STM3999000	3/4	250	500	184.4	368.8	10	2.4	5.3	36
A	EABAHT 500-10	STM4004000	3/4	250	500	184.4	368.8	10	2.4	5.3	36
A	EABCHT 500-10	STM4009000	3/4	250	500	184.4	368.8	10	2.4	5.3	36
ANGLE VERSION 1000 NM											
B	EABHT 1000-6	STM4000000	3/4	500	1050	368.8	774.4	4	3.6	7.9	36
B	EABAHT 1000-6	STM4005000	3/4	500	1050	368.8	774.4	4	3.6	7.9	36
B	EABCHT 1000-6	STM4010000	3/4	500	1050	368.8	774.4	4	3.6	7.9	36
ANGLE VERSION 1500 NM											
C	EABHT 1500-4	STM4152000	1	550	1500	405.6	1106.3	5	6.7	14.7	36
C	EABAHT 1500-4	STM4153000	1	550	1500	405.6	1106.3	5	6.7	14.7	36
C	EABCHT 1500-4	STM4047000	1	550	1500	405.6	1106.3	5	6.7	14.7	36

• Battery not included in standard offering



ACCESSORIES

please contact your Desoutter representative

Multiplus



Options

- Suspension (cable balancer or cylinder)
- Transducer holders
- Variable center distance (manual, automatic by cylinder or motorized)

PART NO.	DESCRIPTION	
615 396 875 0	Handle start horizontal	
615 396 876 0	Handle start vertical	
615 396 877 0	Handle support cpte	
615 396 878 0	Handle reverse	
615 398 135 0	2 additional buttons kit	
615 398 136 0	1 LED + 1 additional button kit	

For further information about technical data, please contact your Desoutter representative or Project Manager for assistance

Customized Machine

Single spindle, Multi spindles, Manual or automatic center distance adjustment



- Standard build components
- Increased customer configuration
- Simplified maintenance
- Proven solution
- Shorter lead time
- Improved ergonomics



ROLLEX

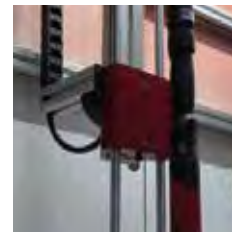
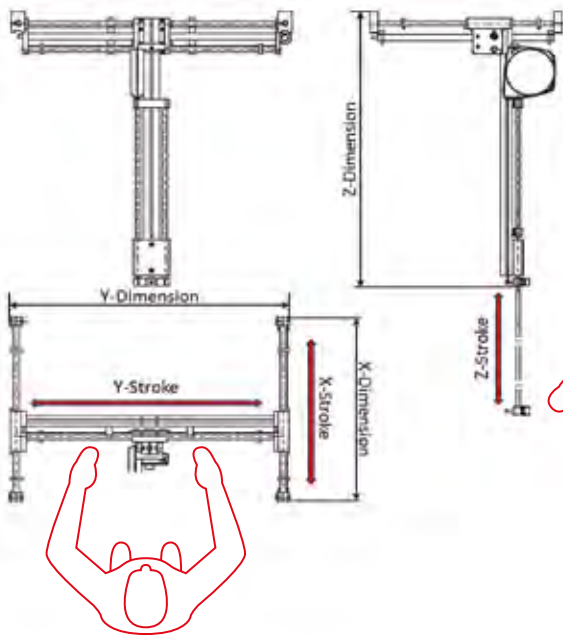

DESCRIPTION	UNIT	TORQUE		
Maximum Torque	N.m (ft.lb)	30 (22.1)	60 (44.2)	90 (66.4)
X-Stroke (min-max)	mm (in.)	250-450 (every 50) 9.8-17.7 (every 1.97)	250-450 (every 50) 9.8-17.7 (every 1.97)	250-450 (every 50) 9.8-17.7 (every 1.97)
Y-Stroke (min-max)	mm (in.)	250-750 (every 50) 9.8-29.5 (every 1.97)	250-750 (every 50) 9.8-29.5 (every 1.97)	250-750 (every 50) 9.8-29.5 (every 1.97)
Z-Stroke (min-max)	mm (in.)	250-500 (every 50) 9.8-19.7 (every 1.97)	250-500 (every 50) 9.8-19.7 (every 1.97)	250-500 (every 50) 9.8-19.7 (every 1.97)
X-Dimensions	mm (in.)	X-Stroke= 260 (10.2)	X-Stroke= 260 (10.2)	X-Stroke= 260 (10.2)
Y-Dimensions	mm (in.)	Y-Stroke= 290 (11.4)	Y-Stroke= 290 (11.4)	Y-Stroke= 290 (11.4)
Z-Dimensions	mm (in.)	Z-Stroke= 1070 (42.1)	Z-Stroke= 1070 (42.1)	Z-Stroke= 1070 (42.1)
Maximum Tightening head weight	kg (lb)	20 (44.1)	25 (55.1)	25 (55.1)

For further information about technical data, please contact your Desoutter representative or Project Manager for assistance

Arms and Torque Tubes



Torque Tubes

- Aluminium (0-250 Nm) (0-185 ft.lb)
- Steel (250-2000 Nm) (185-1480 ft.lb)
- Balancer or pneumatic cylinder suspension



Light Torque Tubes

- Steel (250-1000 Nm) (185-737.5 ft.lb)
- Mono spindle
- Removal cover for balancer maintenance
- Integrated balancer suspension

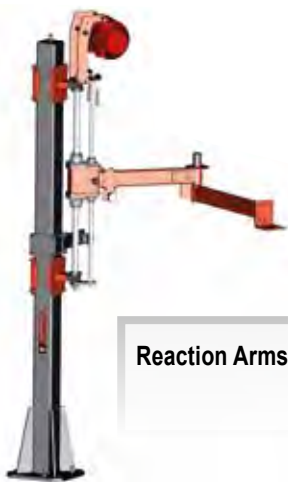

Reaction Arms

Up to 150 Nm (111 ft.lb)
Balancer suspension
Radius 1200 to 2000 mm (3.94 to 6.56 ft)



Ceiling version

Ground version

Up to 300-600 Nm (221-442 ft.lb)
Zero Gravity Carbon Arm
Easy moving manipulation
Radius 1500 to 2500 mm (4.92 to 8.20 ft)



Up to 300-600-1000-2000 Nm (221-442-737-1475 ft.lb)
Pneumatic cylinder suspension
Radius 1600 to 4000 mm (5.25 to 13.12 ft)

Options

Arms options

- Controller and accessories stand
- Parking position sensor
- Encoder (possible on each axis)
- Rotating pillar
- Brakes



Controller support

Encoder / brake



For further information about technical data, please contact your Desoutter representative or Project Manager for assistance

Accessories and Options

Tool holders

Fixed tool holder



X-Rotating tool holder



Indexed X-Rotating tool holder



Z-Rotating tool holder



Indexed Z-Rotating tool holder



Y-Rotating tool holder



Indexed Y-Rotating tool holder



CVI3 HMI & Positioning System



CVI3 HMI

- Standard or specific 4", 7" and 8"
- PC or non PC based
- Plastic or stainless steel enclosure
- From basic input keypad to CVI Advanced HMI
- Multi-tool / Operator guidance working instruction management



CVI3 Positioning System

- can be used in many different cases:
- DSM Arms, D53 Linear and Folded arms, TRA or special Arms
 - Based on connected encoders, positioning system permit to control & guaranty every tightening in order to prevent to forget some bolts or to tighten a bolt already tightened
 - Controlled tightening system
 - Standard, "Relative X & Y" or "Relative X & Y + Z Rotating" mode

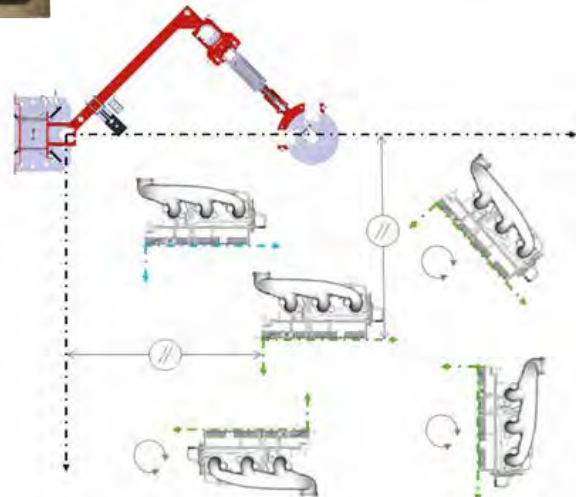

For further information about technical data, please contact your Desoutter representative or Project Manager for assistance

Customized Solutions

CONTROLLER STAND

- 1 Controller CVI3 and accessories or 2 controllers
- 1 Controller Twin CVI3 and accessories or 2 controllers
- Multi CVIL2 - Multi CVI3 - Retractable controller stand
- Different options and cable management included



SPECIAL FUNCTIONS:

- Trombons (vertical and horizontal)
- Special gear boxes simple or with Hold and Drive
- Special gear boxes with 2 spindles

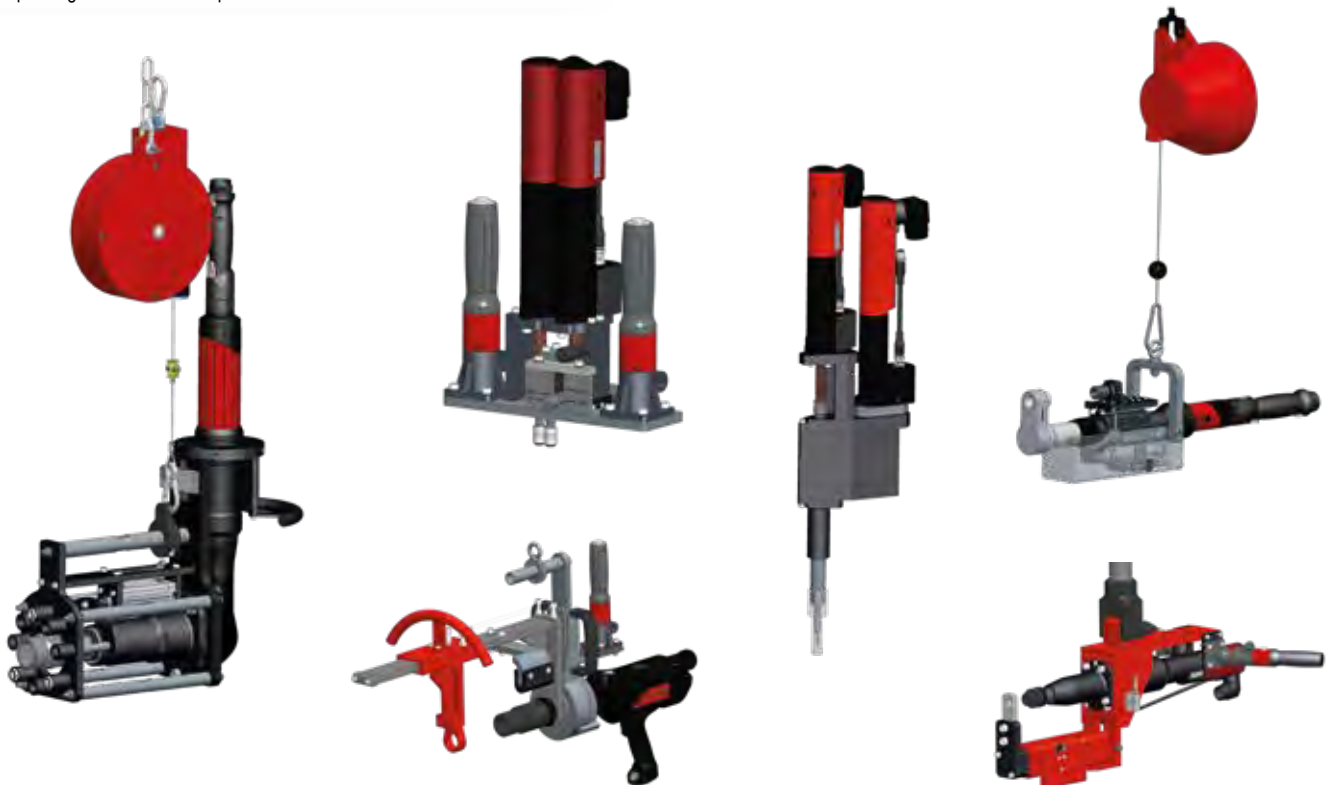

For further information about technical data, please contact your Desoutter representative or Project Manager for assistance

Other Customized Solutions

CUSTOMIZED SOLUTIONS

- 1 spindle with electromagnet and reaction pin with 2 center distances
- Special multi spindle with orientation, center distance adjustment, suspension with brake, ...
- Trolley and arms on trolley

AND MUCH MORE ON REQUEST !



For further information about technical data, please contact your Desoutter representative or Project Manager for assistance

Screwfeeder Solutions - Handheld & Fixtured units

HST - TELESCOPIC HANDHELD UNIT

- High Productivity
- Light and Compact
- Easy to use/ Easy to maintain
- Push Start System



HSF - ADVANCED HANDHELD UNIT

- High performance rate
- Protuding system (retention in jaws)
- Easy to use/ Easy to maintain
- Optional Advanced Nozzle with swivelling arm



SEL/SRL - STATIONARY UNITS

- Simple & flexible
- Dedicated solution robot with SRL / MTB
- Easy to integrate / Easy to maintain
- SEL with 2 strokes / SRL with 1 stroke



	HST	HSF	SEL	SRL
Type	Hand held	Hand held	Fixture	Fixture
Start	Push	lever	Remote	Remote
Stroke	Up to 78 mm	Up to 110 mm	Up to 80/180 mm	Up to 180 mm
Torque	Up to 10 Nm	Up to 15 Nm	Up to 100 Nm	Up to 100 Nm
Pneumatic & Electric Tools	✓	✓	✓	✓
Screw retention in jaws	✗	✓	✗	✗
Recommended installation	Balancer or Arm	Arm	Fixture Installation	Fixture Installation Robot

For further information about technical data, please contact your Desoutter representative or Project Manager for assistance

ZSE – Modular Bowls feeders



Our bowl units have been strongly designed for a quick and easy access to the critical elements, improving effective efficiency and reducing maintenance time



CVI3 controller can control the complete screwfeeding system using CVI logix standard program"

Accessories

SENSORS

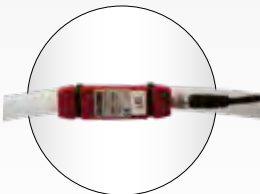

Screw present sensor
Screw feeding detection on hose



Home sensor
Home position detection of cylinders on SEL/SRL

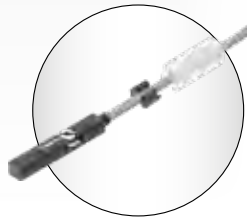

Depth sensor
Depth tightening detection when required by application



Escapement sensors
Control/Secure escapement mechanism

BOWL OPTIONS

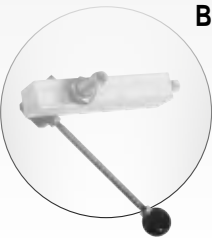

Control level
Detect and inform when the bowl is empty



Hopper
increase your bowl capacity

LINEAR ARMS



Fixtured electric spindles ERF

For your assembly applications, Desoutter offers a range of fixtured electric spindles, transducerized or current controlled with integrated cable

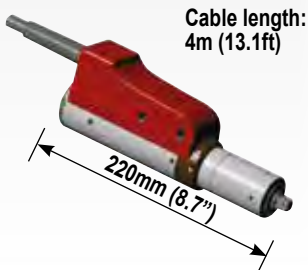

CVIL II Range

MODEL	PART NUMBER	TORQUE RANGE	
		Nm	ft.lb
ERF3L	615 165 286 0	0.35 - 3	0.26 - 2.2
ERF5L	615 165 287 0	0.5 - 5	0.37 - 3.7
ERF10L	615 165 288 0	3 - 10	2.2 - 7.4
ERF20L	615 165 289 0	5 - 20	3.7 - 14.8
ERF20S	615 165 290 0	5 - 20	3.7 - 14.8
ERF30S	615 165 291 0	7 - 30	5.2 - 22.1

For further information about the technical data see pages 65

For further information about technical data, please contact your Desoutter representative or Project Manager for assistance

Quality Assurance Techniques

Statistical quality assurance techniques help organizations to achieve over 30% defect reduction annually. They reflect a growing trend throughout the industry to become more quantitative about quality.

Activities to implement start from the qualification of your assembly tools in inventory, and the regular tests of their performance over their lifetime.

But over the simple measurement of Power Tools performances, Quality Assurance allows a continuous improvement of processes.

Using Six Sigma for process improvement (DMAIC):

- **DEFINE:** Set the goal
- **MEASURE:** Define the metrics
- **ANALYZE:** Measure where you go
- **IMPROVE:** Improve Processes while you go
- **CONTROL:** Act immediately if going on the wrong path

Measure and Analyze are the main added value of the range exposed in following pages.

Based on your Control Plan, the different solutions we provide in Measurement Techniques allow you to:

- Take control of the Capability and repeatability of Assembly tools from their reception in the factory, and make it sustainable and traceable with Machine Capability Tests and Calibration reports.
- Qualify the selected tools for specific operations in regards to the periodical tests performed.
- Measure in SPC the output of production and get clear guidance to implement preventive maintenance or detect a process deviation on critical operations.
- Enable documentation of your tightening operations from engineering phase to quality audits.

As a manufacturer of Industrial Tools, measurement systems, and service provider Desoutter is your partner to make your investment sustainable and cost effective.



Delta Data Collector and Analyzer

Delta 1D / Delta 6D / Delta 7D

Delta Analyzer is a portable solution to perform Assembly line Audits, measure and detect deviations in SPC, execute Machine Capability Test to prove that the inventory of tools is under control.

Combined with the entire range of standard Desoutter transducers (rotary, static and wrenches) it allows a continuous roll out of the Control Plan in Production and enables calibrations of pulse tools, pneumatic and electric nutrunners, spindles, screwdrivers and wrenches.



MAIN FEATURES

- **Display:** Large color screen shows clear test results, Torque & Angle curves. Real time statistics, Tools description and Routes
- **Connectivity:** Ethernet and USB port for Delta QC software communication and RS232 for communication to controllers (calibrations) or barcode reader
- **Power:** Li-Ion high capacity battery of 16 hours of autonomy or external power supply
- **Transducer:** Standard Desoutter connector for Digital transducers, Analog CMD and GSE transducer connection through optional adapters.
- **Barcode (Delta 7D):** Embedded Barcode for automatic Pset selection or VIN traceability



MAIN BENEFITS

■ Machine Capability Tests (Maintenance Operators)

- Perform tools dynamic on-line verifications with Digital Rotary Transducers with minimal disturbance in production with clear outputs thanks to SPC mode.
- Check the repeatability of tools after adjustment or perform tools transducers calibrations or carry full tool check after repair / maintenance, using Static transducers to report Cm/Cmk.
- Compare Tools performances on a job to define backup solutions.

■ Process Capability Tests (Quality Operators)

- Plan routes and focus to execute a Control Plan on the critical operations where Quality Control is the most valuable to detect deviations and avoid non desired costs due to rejects.
- Carry Joint checks verifications campaigns with a Digital Torque & Angle wrench.
- Measure in real time and with precision the outputs of a tightening tool in production, with a direct access to curves and real time statistics, removing manual work / reports.



Test in static
(PST)



Test in dynamic
(DRT)



Post-production
Joint check (DWTA)

This range of 3 models delivers 3 levels of usage:

- Basic : DELTA 1D for Torque measurement only.
- Essential : DELTA 6D for Torque & Angle measurements.
- Advanced : DELTA 7D, adding to the Delta 6D model an embedded barcode scanner which makes it the ideal daily companion for both Maintenance operations and Quality Control data collection during line Audits. This model also allows joint analysis with different production strategies, as well as Residual Torque Checks (with DWTA wrenches), and SPC campaigns.

Delta Data Collector and Analyzer

Delta 1D / Delta 6D / Delta 7D

MODEL	PART NUMBER	POWER REQUIREMENTS		DIMENSIONS						WEIGHT	
		BATTERY LIFE	CHARGER	DEPTH		WIDTH		HEIGHT		kg	lb
		hours	Volt	mm	in.	mm	in.	mm	in.		
Delta 1D	615 935 101 0	16	110/240	45	1.77	95	3.74	192	7.56	0.5	1.1
Delta 6D	615 935 102 0	16	110/240	45	1.77	95	3.74	192	7.56	0.5	1.1
Delta 7D	615 935 147 0	16	110/240	45	1.77	95	3.74	192	7.56	0.5	1.1

All models are supplied with box including Battery, Power Supplier and Delta QC Free Version

	DELTA 1D Basic	DELTA 6D Essential	DELTA 7D Advanced
Onboard Functionalities			
Tool Checks (Power tool, Pulse tool, Wrenches)	✓	✓	✓
Min, Max, Avg, Sigma statistics	✓	✓	✓
Cm/Cmk and SPC	-	✓	✓
Joint Checks / Quality Strategies	-	-	✓
Hardware Capability			
Number of channels	1	1	1
Digital transducers (DRT, PST, FCT, DSTxs)	✓	✓	✓
Analog transducers* (CMD, GSE, 19 pins analog transducers)	✓	✓	✓
DWTA for Joint Checks and Analysis	-	-	✓
Size	95 x 192 x 49	95 x 192 x 49	95 x 192 x 49
Keyboard	✓	✓	✓
Color display	✓	✓	✓
Torque	✓	✓	✓
Angle	-	✓	✓
Clamping Force	✓	✓	✓
Embedded Tools database	1	1000	1000
Embedded Psets database	1 in manual	1000	1000
Results storage	1000	5000	5000
Curves storage (visible on display)	10	10	10
Embedded Barcode reader	-	RS232 (not included)	✓
RS232 / RJ45 (Ethernet) & USB port	✓	✓	✓

*Through optional analog/digital adapter

	FREE	LICENSED	ADVANCED
Software			
View / Export results and Curves	✓	✓	✓
Configure Tests strategies	✓	✓	✓
Define Routes (up to 32.000) for a fleet of Delta 6D/7D	-	✓	✓



SOFTWARES
see page 79

Main functions of Delta Analyzer

Delta 1D / Delta 6D / Delta 7D



- **Connectivity:** Ethernet / RS232 / USB Port (Transfer of results in Delta QC SQLite database for an overall traceability from all transducers.)
- **Power:** Li-Ion high capacity battery (16 hours)
External power supply
- **Barcode:** For Pset selection / Traceability
- **Transducer:** Connector to fit a large range of transducers (Rotary / Static / Load transducers and DWTA wrench)

Digital Transducers:



DRT



PST



DSTxs



FCT



DWTA

Accessories for Delta

ACCESSORIES INCLUDED

	PART NO.
1 Delta Battery	615 936 142 0
2 Universal Power Supplier	615 936 143 0



(belt clip included)

OPTIONAL ACCESSORIES

ITEM	PART NO.
3 Rubber Protection	615 936 141 0
4 Digital 10 pins Cable 2m	615 917 430 0
• Digital 10 pins Spiral Cable 2m	615 917 432 0
• Digital 10 pins Cable 5m	615 917 433 0
• CMD & ST 4000 Adapter	615 917 671 0
• CMD 5000 Adapter	615 917 672 0
• RS232 Adapter	615 917 670 0
• GSE 2500 Adapter	615 917 674 0
• GSE 8500T Adapter	615 917 675 0
• GSE 8500T/A Adapter	615 917 676 0
• Analog 19 pins Adapter	615 935 175 0
5 Delta Demo Case (Empty)	615 936 140 0
6 Delta QC Licensed - 1 user	615 927 651 0
6 Delta QC Licensed - 5 user	615 927 652 0
6 Delta QC Advanced 1 user	615 927 653 0
6 Delta QC Advanced 5 user	615 927 654 0



DWTA - Quality Digital Wrench

Digital wrench for Process Capability Tests in a route (Delta 7D platform)

Aimed primarily for Quality Residual Torque checks organized in routes (Process Capability Tests) and Joint analysis for engineering purposes, the DWTA in combination with Delta 7D offers also a possibility to perform tightening strategies in restricted access conditions with a high level of precision and curves / results and statistics displayed.

MODEL	PART NUMBER	RANGE		ANGLE	DRIVE		INCLUDED RATCHET	LENGTH		WEIGHT	
		Nm	ft lb		mm	in.		mm	in.	kg	lb
DWTA 30	615 165 760 0	3-30	2.21-22.1	✓	9x12	0.35x0.47	3/8	402	15.8	0.9	2.0
DWTA 150 Short	615 165 761 0	15-150	11.06-110.6	✓	14x18	0.55x0.71	1/2	418	24.6	1.8	4.0
DWTA 400	615 165 762 0	40-400	29.5-295	✓	14x18	0.55x0.71	3/4	1026	40.4	2.8	6.2

no TAG feature available for DWTA / see end-fittings page 180-181



■ DWTA

■ Non Length Dependent Transducer thanks to double bridge strain gauge. To guarantee a tightening result independent from operator hand position +/- 1 % of torque reading (from 10 % to 100 % of torque range)



■ Military connector for standard transducer cable



■ Delta7D

■ DWTA

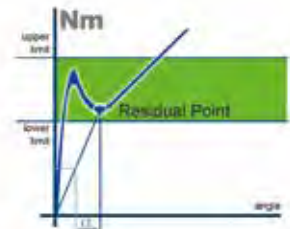

Automatic Residual torque check

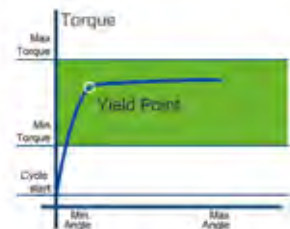

Joint analysis

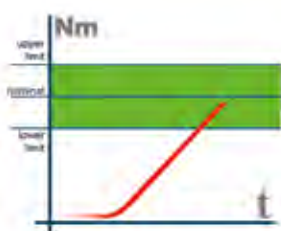
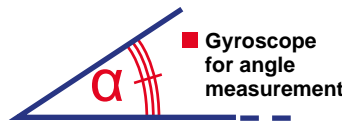

Tightening within torque limits

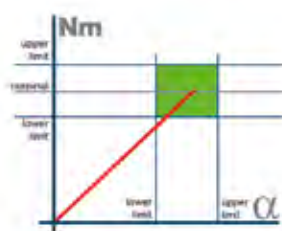

Tightening within torque and angle limits (tightening to a window)

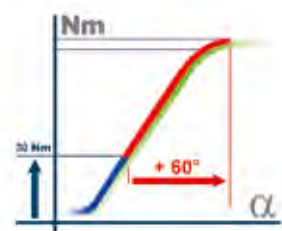

Tightening with torque and additional angle rotation (torque + angle)





Digital Rotary Transducers & Accessories

Torque & Angle

The DRT5 series associated with a Delta 6D or Delta 7D are including an Angle measurement encoder to allow both Torque AND Angle quality controls (preferred series in case you are using Angle strategies and/or monitoring).



MODEL	PART NUMBER	TORQUE RANGE		OUTPUT
		Nm	ft lb	
DRT5				
DRT 5 H 2	615 165 218 0	0.2 - 2	0.15 - 1.5	Hex ¼"
DRT 5 H 5	615 165 219 0	0.5 - 5	0.37 - 3.7	Hex ¼"
DRT 5 H 20	615 165 220 0	2 - 20	1.47 - 14.7	Hex ¼"
DRT 5 Sq 20	615 165 221 0	2 - 20	1.47 - 14.7	Sq ¼"
DRT 5 Sq 25	615 165 222 0	2.5 - 25	1.84 - 18.4	Sq ⅜"
DRT 5 Sq 75	615 165 223 0	7.5 - 75	5.53 - 55.3	Sq ⅝"
DRT 5 Sq 180	615 165 224 0	18 - 180	13.2 - 132	Sq ½"
DRT 5 Sq 500	615 165 225 0	50 - 500	36.8 - 368	Sq ¾"
DRT 5 Sq 1400	615 165 226 0	140 - 1400	103.2 - 1032	Sq 1"
DRT 5 Sq 5000	615 165 780 0	500 - 5000	368.5 - 3685	Sq 1-½"

Note: The DRT shall not be used with pulse tools over 50 % of the transducer nominal torque.



FEATURES

- Torque range from 0.2 to 5000 Nm (0.15 to 3685 ft.lb).
- Angle counting system 0.35° resolution.
- Strain gauges transducer: - sensitivity 2mV/V - accuracy +/-0.35% of max. torque.
- Built-in smart chip memory with calibration features: - type of transducer - sensitivity nominal load - serial number.



BENEFITS

- Automatic recognition thanks to internal memory chip storing main data values eliminating any setting mistakes and time losses.
- High reliability due to immunity from external noise thanks to digital communication.
- Communication to data analyzer not sensitive to the cable length.
- Long life durability thanks to industrial design from transducer to housing.

SAME SIZE FOR TORQUE OR TORQUE & ANGLE TRANSDUCER

OUTPUT	A		B		C		E		H		F		G	
	mm	in.	mm	in.	mm	in.	mm	in.	mm	in.	mm	in.	mm	in.
Hex ¼"	116	4.56	31	1.22	71.9	2.83	56	2.2	15.5	0.61	39	1.53	25.5	1
Sq ¼"	71.5	2.81	31	1.22	71.9	2.83	56	2.2	15.5	0.61	6	0.24		
Sq ⅜"	77	3.03	31	1.22	71.9	2.83	56	2.2	15.5	0.61	8	0.31		
Sq ½"	87	3.42	42	1.65	82.9	3.26	58	2.28	21	0.83	12	0.47		
Sq ¾"	106	4.17	52	2.05	92.9	3.66	66	2.60	26	1.02	21	0.83		
Sq 1"	125	4.92	65	2.56	104.9	4.13	73	2.87	32.5	1.28	29	1.14		
Sq 1-½"	165	6.5	106	4.17	148.5	5.85	88	3.46	53	2.09	35.2	1.39		

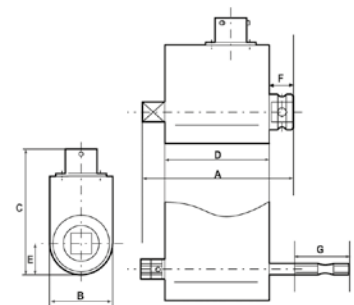

DRT - Digital Rotary Transducers

Torque

The DRT4 rotary transducer series are designed to measure torque output (Only) of any non-impact assembly tool, directly on your application in dynamic mode.



+ **FEATURES**

- Torque range from 0,2 to 10000 Nm (0.15 to 7375 ft.lb).
- Strain gauges transducer: - sensitivity 2mV/V - accuracy +/-0.35% of max. torque.
- Built-in smart chip memory with calibration features: - type of transducer - sensitivity nominal load - serial number.

MODEL	PART NUMBER	TORQUE RANGE		OUTPUT
		Nm	ft lb	
DRT4				
DRT 4 H 2	615 165 209 0	0.2 - 2	0.15 - 1.5	Hex ¼"
DRT 4 H 5	615 165 210 0	0.5 - 5	0.37 - 3.7	Hex ¼"
DRT 4 H 20	615 165 211 0	2 - 20	1.47 - 14.7	Hex ¼"
DRT 4 Sq 20	615 165 212 0	2 - 20	1.47 - 14.7	Sq ¼"
DRT 4 Sq 25	615 165 213 0	2.5 - 25	1.84 - 18.4	Sq ⅜"
DRT 4 Sq 75	615 165 214 0	7.5 - 75	5.53 - 55.3	Sq ⅜"
DRT 4 Sq 180	615 165 215 0	18 - 180	13.2 - 132	Sq ½"
DRT 4 Sq 500	615 165 216 0	50 - 500	36.8 - 368	Sq ¾"
DRT 4 Sq 1400	615 165 217 0	140 - 1400	103.2 - 1032	Sq 1"
DRT 4 Sq 3000	615 165 536 0	300 - 3000	221.1 - 2211	Sq 1-½"
DRT 4 Sq 5000	615 165 540 0	500 - 5000	368.5 - 3685	Sq 1-½"
DRT4 Sq 10000	615 935 164 0	1000 - 10000	736.6 - 7375	Sq 1-½"

Note: The DRT shall not be used with pulse tools over 50 % of the transducer nominal torque

TRANSDUCER CABLES

MODEL	PART NUMBER	DESCRIPTION
2m (78.7") - 10 pins	615 917 430 0	For DRT / PST / DSTxs / FCT - all Delta Models
2m (78.7") spiral - 10 pins	615 917 432 0	For DRT / PST / DSTxs / FCT - all Delta Models
5m (196.8") - 10 pins	615 917 433 0	For DRT / PST / DSTxs / FCT - all Delta Models

PST - Pulse Static Transducer

Designed for testing hand wrenches, click wrenches, Pneumatic Pulse tools and electric nutrunners, the Pulse Static Transducer is the ideal solution to provide a periodic and static mean of control for audit at the station and will cover all your assembly tools in the production area.

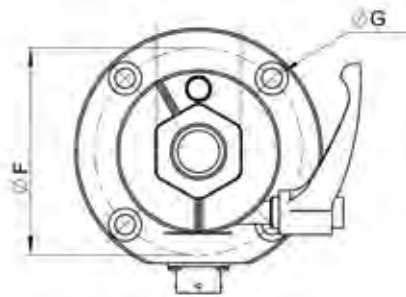
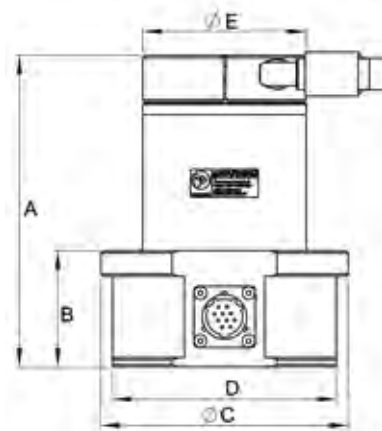
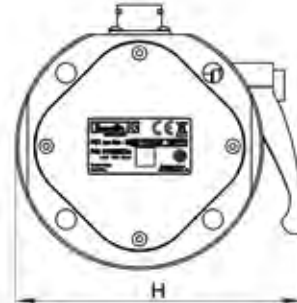

(reminder: the joint simulator is required accessory in the case of a shut-off pulse or nutrunner tool test).

FEATURES

- Torque accuracy +/-0.35% of torque max.
- Built-in smart chip memory with calibration features:
 - type of transducer - sensitivity nominal load - serial number
- Lever to clamp the Joint simulator firmly for impulse tools
- Recommended for Pulse tools

MODEL	PART NUMBER	TORQUE RANGE		DIMENSIONS (MM)								INPUT	WEIGHT		
		Nm	ft lb	A	B	C	D	E	F	G	H		kg	lb	
PST															
PST 2 Nm - 13	615 935 220 0	0.2 - 2	0.15-1.5	83	39	80	69	45	64	4x Ø 6.5	/	Sq 1/2"	1.4	3.1	
PST 5 Nm - 13	615 935 221 0	0.5 - 5	0.37 - 3.7	83	39	80	69	45	64	4x Ø 6.5	/	Sq 1/2"	1.4	3.1	
PST 10 Nm - 13	615 935 222 0	1-10	0.74-7.4	83	39	80	69	45	64	4x Ø 6.5	/	Sq 1/2"	1.4	3.1	
PST 25 Nm - 36	615 935 223 0	2.5-25	1.8-18	134	50	106	96	70	89	4x Ø 8.5	123	Hex 36	4	8.8	
PST 50 Nm - 36	615 935 224 0	5-50	3.7-37	134	50	106	96	70	89	4x Ø 8.5	123	Hex 36	4	8.8	
PST 100 Nm - 36	615 935 225 0	10-100	7.4-74	134	50	106	96	70	89	4x Ø 8.5	123	Hex 36	4	8.8	
PST 250 Nm - 36	615 935 226 0	25-250	18.4-184	134	50	106	96	70	89	4x Ø 8.5	123	Hex 36	4	8.8	
PST 500 Nm - 50	615 935 227 0	50 - 500	36.9-369	170	50	148	136	108	125	6x Ø 8.5	180	Hex 50	10.1	22.3	
PST 1000 Nm - 50	615 935 228 0	100-1000	73.8-738	170	50	148	136	108	125	6x Ø 8.5	180	Hex 50	10.1	22.3	
PST 2000 Nm - 50	615 935 229 0	200-2000	147.5-1475	170	50	148	136	108	125	6x Ø 8.5	180	Hex 50	10.1	22.3	



Joint Simulator

A wide range of mechanical joint simulators are available to reproduce the joint behavior; installing the joint simulator on a transducer allows you to test a tool in the same repeatable working conditions. Each joint simulator reproduces a specific stiffness as described in its torque/angle characteristics. For each capacity, there are two versions: one reproducing a softer joint and one reproducing a harder joint.

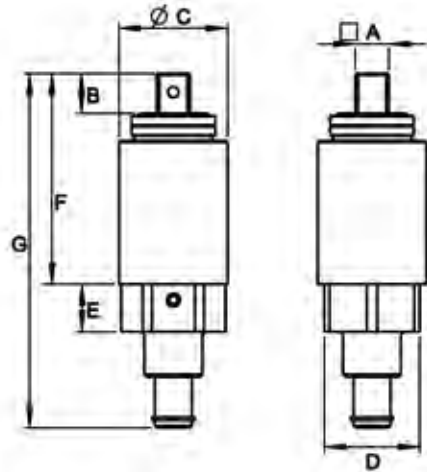

MODEL	PART NUMBER	COLOR	DIMENSIONS (MM)							
			A	B	C	D	E	F	G	
DJS										
DJS for DST and PST 2 Nm SOFT	615 165 529 0	YW – YW	HEX ¼"	14	24	Sq. ½"	8	50	71,5	
DJS for DST and PST 2 Nm HARD	615 165 530 0	YW – BK	HEX ¼"	14	24	Sq. ½"	8	50	71,5	
DJS for DST and PST 5 Nm SOFT	615 165 531 0	GR – YW	HEX ¼"	14	24	Sq. ½"	8	50	71,5	
DJS for DST and PST 5 Nm HARD	615 165 571 0	GR – BK	HEX ¼"	14	24	Sq. ½"	8	50	71,5	
DJS for PST 10 Nm SOFT	615 936 377 0	RD - YW	HEX ¼"	14	24	Sq. ½"	8	50	71,5	
DJS for PST 10 Nm HARD	615 936 378 0	RD - BK	HEX ¼"	14	24	Sq. ½"	8	50	71,5	
DJS for PST 25 Nm SOFT	615 936 379 0	RD – YW	Sq. ⅜"	11	34	Hex 36	16,5	70	120,5	
DJS for PST 25 Nm HARD	615 936 380 0	RD – BK	Sq. ⅜"	11	34	Hex 36	16,5	70	120,5	
DJS for PST 50 Nm SOFT	615 936 381 0	BL – YW	Sq. ½"	15	41	Hex 36	18	84	133,5	
DJS for PST 50 Nm HARD	615 936 382 0	BL – BK	Sq. ½"	15	41	Hex 36	18	84	133,5	
DJS for PST 100 Nm SOFT	615 936 365 0	VL – YW	Sq. ½"	15	41	Hex 36	18	84	133,5	
DJS for PST 100 Nm HARD	615 936 366 0	VL – BK	Sq. ½"	15	41	Hex 36	18	84	133,5	
DJS for PST 250 Nm SOFT	615 936 384 0	GY – YW	Sq. ½"	15	41	Hex 36	18	84	133,5	
DJS for PST 250 Nm HARD	615 936 385 0	GY – BK	Sq. ½"	15	41	Hex 36	18	84	133,5	
DJS for PST 500 Nm SOFT	615 936 369 0	BK – YW	Sq. ¾"	22	59	Hex 50	30	141	224	
DJS for PST 500 Nm HARD	615 936 370 0	BK – BK	Sq. ¾"	22	59	Hex 50	30	141	224	
DJS for PST 1000 Nm	615 936 386 0	no color	Sq. 1"	28	90	Hex 50	30	179	273	
DJS for PST 2000 Nm	615 936 393 0	no color	Sq. 1 ½"	38	138	Hex 50	30	168.2	218.2	



ADAPTERS & COUPLINGS

(Accessories for Static transducers & Joint simulators).



MODEL	PART NO.
HEX 36 M-3/8" F	615 936 398 0
HEX 36 M-1/2" F	615 936 399 0
HEX 50 M-1/2" F	615 936 431 0
HEX 50 M-3/4" F	615 936 432 0
HEX 50 M-1" F	615 936 433 0
HEX 1/4" M-1/4" F	615 936 118 0
HEX 1/4" M-3/8" F	615 936 119 0

Direct adapter for Non shut-off pulse tools and click wrenches (without DJS).

MODEL	PART NO.	MODEL	PART NO.	MODEL	PART NO.
3/4" M-1/4" F	615 397 205 0	1/2" M -3/8" F	615 936 111 0	HEX 1/4" M-1/4" F	615 936 118 0
3/4" M-3/8" F	615 397 206 0	1/2" F-3/8" F	615 936 112 0	HEX 1/4" M-3/8" F	615 936 119 0
1" M-1/2" F	615 397 207 0	1/2" M-1/2" F	615 936 113 0	1" F-3/4" F	615 936 126 0
1" 1/4 M-1/2" F	615 397 208 0	1" 1/4 M-3/4" F	615 936 114 0	3/4" F-1/2" F	615 936 130 0
1" 1/4 M-3/4" F	615 397 209 0	1/4" F-3/8" F	615 936 115 0	1" 1/2 F-1" 1/2 F	615 936 436 0
1/4" F-1/4" F	615 397 210 0	1" 1/4 M-1" F	615 936 116 0	1/2" F-1/2" F	615 165 573 0
3/8" F-3/8" F	615 397 211 0	1" F-1" F	615 936 117 0	3/4" F-3/4" F	615 165 576 0
1" M-3/4" F	615 936 110 0				

DSTxs Series - Digital Static Transducers

Nano-torques applications (< 1 Nm)

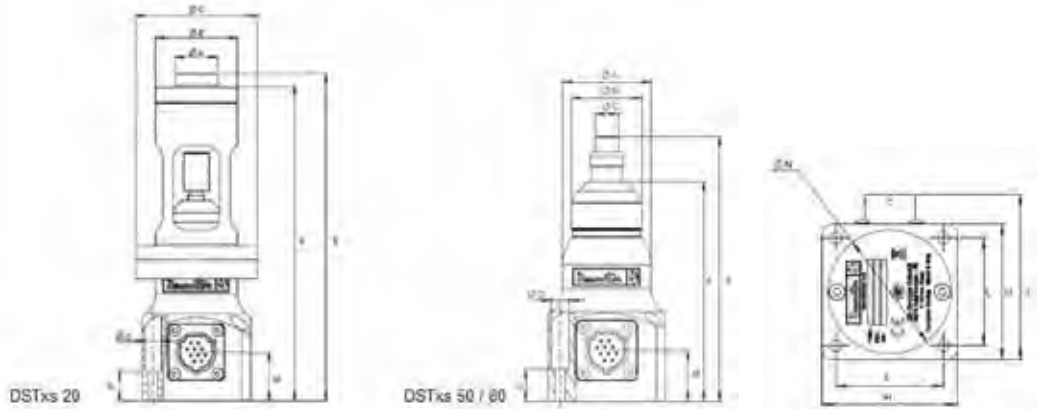

Ideal for Nanodrivers.



FEATURES

- Accuracy from 10% to 100% of the nominal torque : +/-0,5% FSD (Full Scale Deviation) - Overload at 120% of nominal capacity.
- Stability of Zero offset with temperature: $\leq \pm 0.1\%$ FSD/°C - Operating temperature: 5 to 40°C.
- Built-in memory with calibration features: Serial Number, Transducer Type, Sensitivity, Nominal Load, Calibration / Maintenance date, Tightening counter, Damage limit.



BENEFITS

- Automatic recognition thanks to internal memory chip storing main data values eliminating any setting mistakes and time losses.
- High reliability due to immunity from external noise thanks to digital communication.
- Communication to data analyzer not sensitive to the cable length.

MODEL	PART NUMBER	TORQUE RANGE		SQUARE DRIVE	DIMENSIONS										WEIGHT	
					Ø A		Ø B		Ø C		L		H			
		cNm	in. lbs	in	mm	in	mm	in	mm	in	mm	in	mm	in	kg	lb
DSTxs 20 cNm	615 165 752 0	2-20	0.17-1.77	dia 3mm	20	0.787	39	1.535	58	2.283	41	1.614	51.5	2.027	0.56	1.2
DSTxs 50 cNm	615 165 754 0	5-50	0.44-4.42	Hex 1/4	39	1.535	32	1.259	10.5	0.413	41	1.614	51.5	2.027	0.42	0.9
DSTxs 80 cNm	615 165 764 0	8-80	0.70-7.08	Hex 1/4	39	1.535	32	1.259	10.5	0.413	41	1.614	51.5	2.027	0.42	0.9

JOINT SIMULATOR KITS

(Soft / Hard joints – Min / Max Torques)

MODEL	PART NUMBER	JOINTS COVERED				ADAPTER	SCREW SIZE
		Hard / mini	Soft / mini	Hard / max	Soft / max		
DJSxs 20	615 936 445 0	2-6 cNm	2-6 cNm	20 cNm	20 cNm	dia 3mm	M2
DJSxs 50	615 936 446 0	5-15 cNm	5-15 cNm	50 cNm	50 cNm	Hex 1/4	M2 & M3
DJSxs 80	615 936 447 0	8-24 cNm	8-24 cNm	80 cNm	80 cNm	Hex 1/4	M3

ITEM	CONTENT OF THE DJS KIT SUITCASE
1	DJSxs assembly - min. torque - Soft joint x1
2	Spare compression spacer - min. torque - Soft x4
3	Spare compression spacer - min. torque - Hard x1
4	DJSxs assembly - min. torque - Hard joint x1
5	DJSxs assembly - nominal torque - Hard joint x1
6	Spare compression spacer - nominal torque - Hard joint x1
7	Spare compression spacer - nominal torque - Soft joint x4
8	DJSxs assembly - nominal torque - Soft joint x1
9	DJSxs20 assembly - min./nominal torque - Soft joint - spacer for DSTxs adapter
10	DJSxs20 assembly - min./nominal torque - Hard - spacer for DSTxs adapter

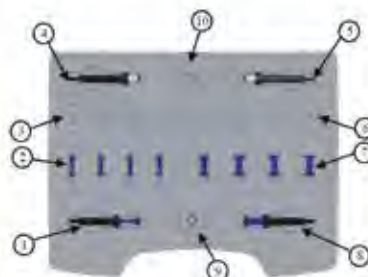

FCT series - Clamp Force Transducers

Measure Pulse Tools repeatability in tension

The purpose of the FCT is to measure the repeatability of a pulse tool in achieving a constant tension independently from the friction effects and detect a deviation over time. Delta 6D/7D can display both the load and equivalent torque.



Ideal for Pulse tools.

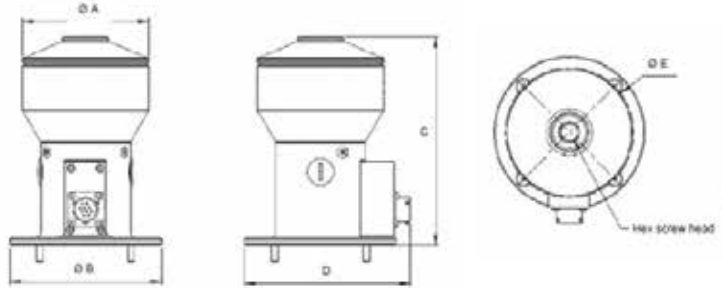

ØA		ØB		C		D		ØE	
mm	in.	mm	in.	mm	in.	mm	in.	mm	in.
96	3.779	115	4.779	157.8	6.21	125.8	4.952	98	3.858

FEATURES

- Accuracy +/-0,5% of Applied Force Reading Value.
- Built-in Load Cell.
- Used with Delta xD data collectors and cables.
- Battery powered with up to 12 hours autonomy.
- Allows a display of both Clamping Force and Torque (K factor)
- Up to 2000 Hz filter selection
- RS-232 interface to download readings in "real time"
- Large screen and easy to use menus (5 languages)
- Supplied with screw kit and 3/8" socket SW13

BENEFITS

- Measures the repeatability of pulse tools to achieve a target clamping force.
- By measuring the clamp force instead of the torque delivered, the adverse effects of adding an in-line torque transducer are eliminated.
- As most design offices specify a clamping force, measuring the actual clamping force allows to eliminate the uncertainty linked to the translation in torque of a clamping value.



MODEL	PART NUMBER	TORQUE RANGE		LOAD RANGE		OVERLOAD				WEIGHT	
		Nm	ft.lbs	N	lbf	FORCE	TORQUE		kg	lb	
FCT30	615 935 249 0	10-30	7.38-22.13	1800-18000	405-4050	23400	5260	39	28.7	2.4	5.3
FCT60	615 935 250 0	20-60	14.75-44.25	2700-27000	607-6070	35100	7890	78	57.5	2.4	5.3

ACCESSORIES INCLUDED

		PART NO.
FCT30	1 FCT30 Screw	615 936 484 0
	2 Sleeve Drive Sockets 3/8" - 13mm	615 811 781 0
FCT60	1 FCT60 Screw	615 936 485 0
	2 Sleeve Drive Sockets 3/8" - 18mm	615 811 784 0



Oil recommended to fill the oil bath: 75W-90.

Calibration Bench

EMBEDDED TRANSDUCERS :

Assembly tools calibration process requires a flexible and versatile solution, high quality performance even in production lines. Desoutter Tools is proud to present the Delta Cart, an ergonomic and attractive solution to improve quality in assembly processes.

- Delta Cart offers a wide torque range since it can be configured up to 4 static transducers to cover from 0.2 Nm to 1 000 Nm (0.15 to 738 ft.lb) in a very compact dimensions (510mm width), making the Delta Cart the ideal solution for tool testing in assembly production lines.
- PST High accuracy static transducers with locking system specially designed for pulse tool calibration
- ISO RIG (mandatory over 200Nm)
System for torque wrench calibration



- Embedded PC equipped with wide 12" color touch screen lets operators to start tool testing in a few seconds and few steps.

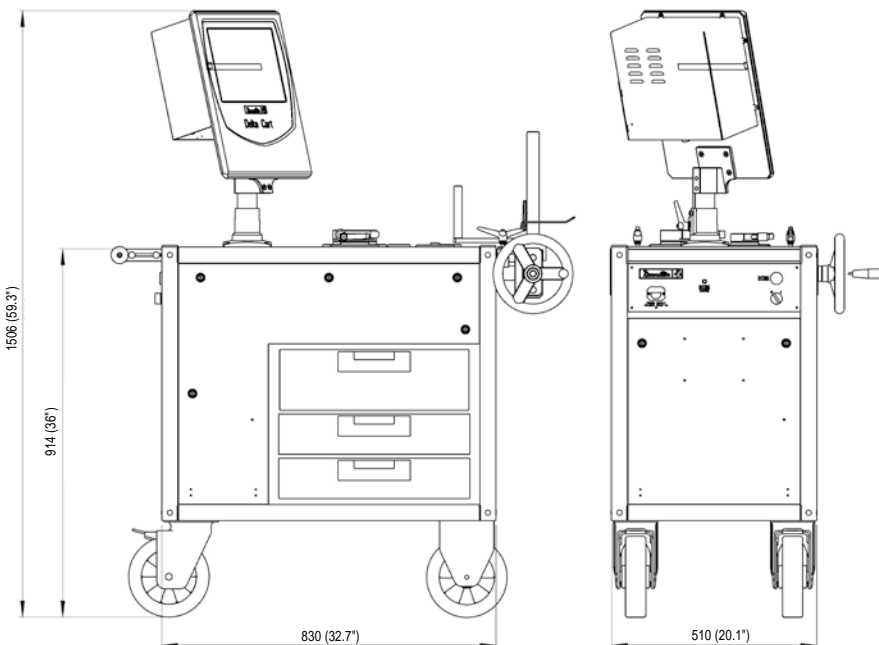

- Delta Cart includes all adapters, reaction bars and suitable joint simulators. Optional ISO RIG for torque wrench to eliminate operator influence during calibration, reducing efforts for high torque range.

Delta Cart Tool Calibration

EMBEDDED TRANSDUCERS :

Assembly tools calibration process requires a flexible and versatile solution, high quality performance even in production lines Desoutter Tools is proud to present the Delta Cart, an ergonomic and attractive solution to improve quality in assembly processes.



Electric and Pneumatic Nutrunner



Shut off and non shut off Pulse Tool



Torque wrench



Click wrench

The Delta Cart is able to follow your tools during the complete life span: by performing capacity test (Cm/Cmk) before tool is introduced into production, or monitoring tool performance during production assembly process by performing Statistic Process Control (SPC) test

+

TECHNICAL FEATURES

- Configurable torque range from 1 Nm to 2000Nm
- Torque reaction bar and joint simulator included
- External DRT communication for in-line calibration
- Angle Strategy with external DRT5
- CVI2 and CVI3 autocalibration
- Double reading calibration with automatic deviation check



Embedded Software with local tool DB (SQL Server)

- Tools Inventory with calibration status and next calibration date (Excel sheet export)
- Calibration STATUS
- Cm/Cmk Reports
- SPC X/R Charts
- USER Management - login per user

SOFTWARE

see page 79

- CLIENT - SERVER Architecture**
 - Ideal for > 1 cart management
 - All Calibration data always synchronized with unique Server database
 - Fast Ethernet communication
- ROUTE MANAGEMENT**
 - Send to Delta Cart just the Tool to be tested

SOFTWARE FEATURES	
Torque Wrench, Electric or Pneumatic Nutrunner Test, Pulse Test Cm/Cmk - ISO 3534	Local Test Database up to 30000 Tests - Setting: Nominal Min Max Torque, unit of measure, Test Id, Test Description, Transducer number, Timeout setting Cm/Cmk, min, max, average, sigma
ISO 6789 - ISO 5393	Automatic test report
Statistic Control - ISO 8258 Print	X/R Charts for trend control Direct Printing from Delta Cart PC software
Export Curve	Certificate export to PDF or XLS Torque/Time or Torque/Angle with external DRT5
Barcode Configurable for each test	External USB N.m - gf.cm - Kgf.cm - kgf.m - ozf.in - lbf.in - lbf.ft
Languages	English, French, Italian, German, Russian

Alpha Low Torque Analyzer

Dedicated torque analyzers for the setting and static test checks of low torque screwdrivers, either pneumatic or electric.



■ Embedded Transducer & Battery



TECHNICAL SPECIFICATION

Torque Transducer	Embedded
Torque Accuracy	+/-1 % of readings
Tools Testing	Torque Wrench, Nutrunner or Pulse Tools
Statistic	Min. Max, Average, Standard Deviation
Results Storage	1000 + 10 curves with DeltaQC Licenced
Multi-units	N.m, Kg.m, Kg.cm, Oz.in, Lb.in, Lb.ft, N.cm
Display	Red, Green, Blue backlight
Power Supply	Embedded Battery External power supply
Battery Autonomy	Up to 12 hours
Languages	French, English, Spanish, Italian, Deutsch, Portuguese
Software	Free Delta QC Software to export by USB result

Alpha Low Torque Analyzer



MAIN FEATURES

- Alpha D Series is designed to monitor and collect torque check results from screwdrivers, torque wrenches or click wrenches.
- Ideal to tune the tools thanks to real time statistics on color display and high capacity torque results storage.
- Traceability with included software result acquisition with time stamp, including PDF or XLS reports.
- Three models with embedded transducer to cover torque range from 0,1 to 16 Nm. All models are provided with two included joint simulators to test nutrunner according to different joint stiffness condition.



■ Backlight RGB color display with acoustic buzzer

■ Hard & Soft Joint Simulator



MODEL	PART NUMBER
DJS for Alpha_D1 Soft	615 936 120 0
DJS for Alpha_D1 Hard	615 936 121 0
DJS for Alpha_D5 Soft	615 936 122 0
DJS for Alpha_D5 Hard	615 936 123 0
DJS for Alpha_D16 Soft	615 936 124 0
DJS for Alpha_D16 Hard	615 936 125 0
Universal Power Supplier	615 936 143 0

MODEL	PART NUMBER	P. CHARGER	TORQUE RANGE		DEPTH		WIDTH		HEIGHT		WEIGHT	
			Nm	in. - lb	mm	in.	mm	in.	mm	in.	kg	lb
Alpha D1	615 935 140 0	110/240V	0.1 - 1	0.88 - 8.85	106	4.17	180	7.09	70	2.76	0.95	2.1
Alpha D5	615 935 141 0	110/240V	0.5 - 5	4.42 - 44.25	106	4.17	180	7.09	70	2.76	0.95	2.1
Alpha D16	615 935 142 0	110/240V	1.6 - 16	14.1 - 141.6	106	4.17	180	7.09	70	2.76	0.95	2.1

All models are supplied with external power supply, suitable hard and soft joint simulators and Delta QC Software

QShield - Standalone

Quality Checks Digital Wrench - Torque & Angle

RFID TAG End-fittings with automatic recognition for ratio management and/or Pset selection

Standard interchangeable heads and reversible ratchets



New Digital Twin



New Gyroscope (Angle 1,2° to 250°/s)



Length independent transducer with double bridge strain gauge to guarantee a tightening result regardless of the position of the operator's hand.

Accuracy of +/-1% on Torque reading value (from 10 to 100% of the nominal torque)



Mini USB port for Configuration, data export to Delta QC software & Calibrations



RGB Color display Visual feedback AND a complementary configurable vibration for operator guidance

New Li-Ion Battery 10 hours autonomy on QShield-S

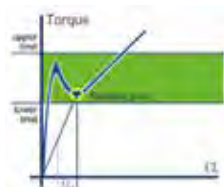

- ISO 6789:2017 compliance
- Quality Strategies
- Joint Analysis
- Delta QC platform software



Audit & Joint Analysis Digital Wrench

QSHIELD-S SERIES provide a freedom for Quality Operators and Process Engineers to use the wrench in a free mode and independently from production datas: Joint check during audits, conduct Joint analysis on prototypes to or simply retightening mode to secure a joint.

- 5 methods of Residual Torque checks (as per VDI-VDE 2645 part 3).
- Menus are accessible for a versatile usage by a trained staff.
- The vibrating handle (configurable threshold) provides an immediate feedback even in a loud environment of work.
- Results & Curves are stored in the wrench until downloaded on Delta QC (Quality Control Software).



ACCESSORIES
see page 180-181

MODEL	PART NUMBER	RANGE		ANGLE	DRIVE		INCLUDED RATCHET	LENGHT WITHOUT RATCHET		LEVER ARM*		WEIGHT	
		Nm	ft.lbs		mm	in.		in.	mm	in.	mm	in.	kg
Q-SHIELD 30-S	615 935 210 0	3 - 30	2.21 - 22.13	✓	9x12	0.35x0.47	3/8	402	15.83	320	12.6	0.7	1.5
Q-SHIELD 150-S	615 935 211 0	15 - 150	11.06 - 110.6	✓	14x18	0.55x0.71	1/2	418	16.46	342	13.5	0.8	1.7
Q-SHIELD 200-S	615 935 212 0	20 - 200	14.75 - 147.5	✓	14x18	0.55x0.71	1/2	627	24.7	552	21.75	1.6	3.5
Q-SHIELD 350-S	615 221 038 0	35 - 350	25.81 - 258.1	✓	14x18	0.55x0.71	3/4	694	27.33	625.5	24.62	2.6	5.7
Q-SHIELD 400-S	615 935 213 0	40 - 400	29.5 - 295.0	✓	14x18	0.55x0.71	3/4	1028	40.48	960	37.8	3.2	7.0
Q-SHIELD 500-S	615 935 214 0	50 - 500	36.88 - 368.8	✓	21x26	0.82x1.02	3/4	1137	44.77	1100	43.3	5.5	12.1
Q-SHIELD 800-S	615 935 215 0	80 - 800	59.0 - 590.0	✓	dia 28	dia 1.1	1	1314	51.74	1362	53.62	6.7	14.7
Q-SHIELD 900-S	615 935 216 0	90 - 900	66.38 - 663.8	✓	dia 28	dia 1.1	1	1392	54.8	1440	56.7	8.2	18.0

* Useful length is from Ratchet axis to handle middle

All models are supplied with box including reversible ratchet with TAG (QShield Batteries supplied seperately)



PIC REF	MODEL	PART NUMBER	HEIGHT		LENGTH		WIDTH		WEIGHT	
			mm	in	mm	in	mm	in	gr	lb
A	QShield Battery	615 936 500 0	-	-	110	4.33	Ø 22	Ø 8.86	80	0.18
B	Battery Charger	615 936 151 0	60	2.36	140	5.51	80	3.15	240	0.53
C	Wrench Protection	615 936 504 0	-	-	-	-	-	-	-	-



SOFTWARE
see page 79

DELTAQC SOFTWARE	FREE	LICENSED	ADVANCED
PSet programming	✓	✓	✓
Result viewer	✓	✓	✓
Result excel export	✓	✓	✓
Curve viewer		✓	✓
Result Database			✓

MODEL	PART NUMBER
DeltaQC Licensed 1 user	615 927 651 0
DeltaQC Licensed 5 users	615 927 652 0
DeltaQC Advanced 1 user	615 927 653 0
DeltaQC Advanced 5 users	615 927 654 0

QShield-S Strategies



TECHNICAL SPECIFICATION

Standards compliance	ISO 6789:2017 / VDI-VDE 2645-2 & -3
Torque Accuracy	+/-1% of torque reading +/-1 digit from 10 to 100% of nominal torque.
Angle Accuracy	+/-1% from 3°/Sec to 250°/sec
Predefined Pset	250 Psets with T/A defined in Delta QC Software
Batch Count	Up to 99
Results	1000 in memory, last 99 results accessible directly on the wrench display (FIFO) without external PC or software
Curves	25 curves with Delta QC licensed
Quality Audit & Testing Strategies	Residual Torque/Angle Automatic Residual Peak/Torque Residual Torque/Angle Residual Minimum after breakaway Residual Intersection determination Residual Gradient change Residual Loose and Tighten Yield Point (Joint Analysis) Drag Torque
Tightening Strategies	Torque/Time, Torque & Angle, Torque+Angle CW/CCW Tightenings
Extension Management	Torque and Angle bending correction per Pset
USB Communication	Bi-directional communication to Delta QC Software
RGB Display	Red / Green / Blue backlight
Battery	Li-ion battery
Power Autonomy	10 hours on QShield-S
Multi-Units	N.m, kgf.m, lbf.ft, lbf.in, ozf.ft, ozf.in, kp.m, dN.m
Languages	English, Spanish, German, Portuguese, French, Italian
Software	Free Delta QC Software to define Pset and download results (extended capabilities with Licensed and Advanced versions)

BENEFITS

- Real residual torque value without any special programming or setting from operator
- Save time no PC setting are required
- No risk to release an over loaded fastener as mean value is saved
- Residual value operator independent
- Export data for quality & statistic analysis
- Perfect for fast & accurate pulse tools setting

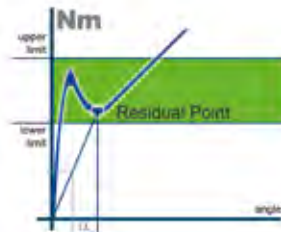

Residual Torque (VDI-VDE 2645-3)

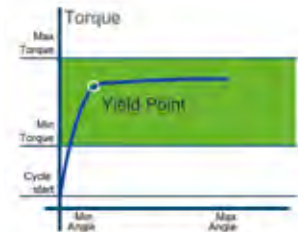

Yield point (Joint Analysis)

OTHER TIGHTENING STRATEGIES ARE ALSO AVAILABLE

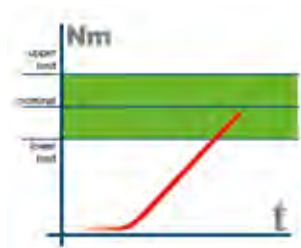

Torque/Time

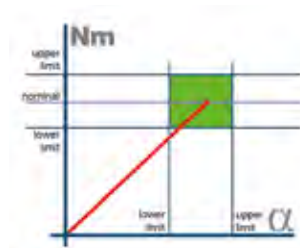

**Torque & Angle
Torque + Angle**

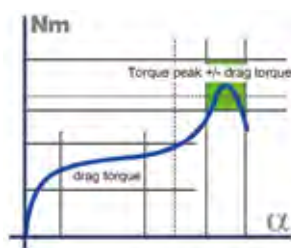

**Prevailing torque
automatic compensation**

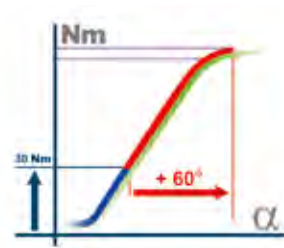

**Tightening with torque and
additional angle rotation
(torque + angle)**



Digital Wrench Accessories

End Fittings with embedded RFID TAG* and NO TAG



OPEN END - metric	TAG	NO TAG
Drive 9x12 Open End 7 mm	615 936 152 0	615 397 055 0
Drive 9x12 Open End 8 mm	615 936 153 0	615 397 056 0
Drive 9x12 Open End 9 mm	615 936 154 0	615 397 057 0
Drive 9x12 Open End 10 mm	615 936 155 0	615 397 058 0
Drive 9x12 Open End 11 mm	615 936 156 0	615 397 059 0
Drive 9x12 Open End 12 mm	615 936 157 0	615 397 060 0
Drive 9x12 Open End 13 mm	615 936 158 0	615 397 061 0
Drive 9x12 Open End 14 mm	615 936 159 0	615 397 062 0
Drive 9x12 Open End 15 mm	615 936 160 0	615 397 063 0
Drive 9x12 Open End 16 mm	615 936 161 0	615 397 064 0
Drive 9x12 Open End 17 mm	615 936 162 0	615 397 065 0
Drive 9x12 Open End 18 mm	615 936 163 0	615 397 066 0
Drive 9x12 Open End 19 mm	615 936 164 0	615 397 067 0
Drive 14x18 Open End 13 mm	615 936 194 0	615 397 131 0
Drive 14x18 Open End 14 mm	615 936 195 0	615 397 132 0
Drive 14x18 Open End 15 mm	615 936 196 0	615 397 133 0
Drive 14x18 Open End 16 mm	615 936 197 0	615 397 134 0
Drive 14x18 Open End 17 mm	615 936 198 0	615 397 135 0
Drive 14x18 Open End 18 mm	615 936 199 0	615 397 136 0
Drive 14x18 Open End 19 mm	615 936 200 0	615 397 137 0
Drive 14x18 Open End 21 mm	615 936 201 0	615 397 138 0
Drive 14x18 Open End 22 mm	615 936 202 0	615 397 139 0
Drive 14x18 Open End 24 mm	615 936 203 0	615 397 140 0
Drive 14x18 Open End 27 mm	615 936 204 0	615 397 141 0
Drive 14x18 Open End 30 mm	615 936 205 0	615 397 142 0
Drive 14x18 Open End 32 mm	615 936 206 0	615 397 143 0
Drive 14x18 Open End 34 mm	615 936 207 0	615 397 144 0

RING BOX END - metric	TAG	NO TAG
Drive 9x12 Ring Box End 7 mm	615 936 165 0	615 397 078 0
Drive 9x12 Ring Box End 8 mm	615 936 166 0	615 397 079 0
Drive 9x12 Ring Box End 10 mm	615 936 167 0	615 397 080 0
Drive 9x12 Ring Box End 11 mm	615 936 168 0	615 397 081 0
Drive 9x12 Ring Box End 12 mm	615 936 169 0	615 397 082 0
Drive 9x12 Ring Box End 13 mm	615 936 170 0	615 397 083 0
Drive 9x12 Ring Box End 14 mm	615 936 171 0	615 397 084 0
Drive 9x12 Ring Box End 15 mm	615 936 172 0	615 397 085 0
Drive 9x12 Ring Box End 16 mm	615 936 173 0	615 397 086 0
Drive 9x12 Ring Box End 17 mm	615 936 174 0	615 397 087 0
Drive 9x12 Ring Box End 18 mm	615 936 175 0	615 397 088 0
Drive 9x12 Ring Box End 19 mm	615 936 176 0	615 397 089 0
Drive 9x12 Ring Box End 21 mm	615 936 177 0	615 397 090 0
Drive 9x12 Ring Box End 22 mm	615 936 178 0	615 397 091 0
Drive 14x18 Ring Box End 13 mm	615 936 208 0	615 397 173 0
Drive 14x18 Ring Box End 14 mm	615 936 209 0	615 397 174 0
Drive 14x18 Ring Box End 15 mm	615 936 210 0	615 397 175 0
Drive 14x18 Ring Box End 16 mm	615 936 211 0	615 397 176 0
Drive 14x18 Ring Box End 17 mm	615 936 212 0	615 397 177 0
Drive 14x18 Ring Box End 18 mm	615 936 213 0	615 397 178 0
Drive 14x18 Ring Box End 19 mm	615 936 214 0	615 397 179 0
Drive 14x18 Ring Box End 21 mm	615 936 215 0	615 397 180 0
Drive 14x18 Ring Box End 22 mm	615 936 216 0	615 397 181 0
Drive 14x18 Ring Box End 24 mm	615 936 217 0	615 397 182 0
Drive 14x18 Ring Box End 27 mm	615 936 218 0	615 397 183 0
Drive 14x18 Ring Box End 30 mm	615 936 219 0	615 397 184 0
Drive 14x18 Ring Box End 32 mm	615 936 220 0	615 397 185 0
Drive 14x18 Ring Box End 34 mm	615 936 221 0	615 397 186 0
Drive 14x18 Ring Box End 36 mm	615 936 222 0	615 397 187 0
Drive 14x18 Ring Box End 41 mm	615 936 223 0	615 397 188 0



FLARED END - metric	TAG	NO TAG
Drive 9x12 Flared End 10 mm	615 936 179 0	615 397 103 0
Drive 9x12 Flared End 11 mm	615 936 180 0	615 397 104 0
Drive 9x12 Flared End 12 mm	615 936 181 0	615 397 105 0
Drive 9x12 Flared End 13 mm	615 936 182 0	615 397 106 0
Drive 9x12 Flared End 14 mm	615 936 183 0	615 397 107 0
Drive 9x12 Flared End 16 mm	615 936 184 0	615 397 108 0
Drive 9x12 Flared End 17 mm	615 936 185 0	615 397 109 0
Drive 9x12 Flared End 18 mm	615 936 186 0	615 397 110 0
Drive 9x12 Flared End 19 mm	615 936 187 0	615 397 111 0
Drive 9x12 Flared End 21 mm	615 936 188 0	615 397 112 0
Drive 9x12 Flared End 22 mm	615 936 189 0	615 397 113 0
Drive 9x12 Flared End 24 mm	615 936 190 0	615 397 114 0

BLANK END	TAG	NO TAG
Drive 9x12 Blank End	615 936 228 0	615 397 130 0
Drive 14x18 Blank End	615 936 226 0	615 397 203 0
Drive 21x26 Blank End	615 936 444 0	615 936 443 0

*These accessories fit QShield / DWTA and Delta wrenches

Digital Wrench Accessories

End Fittings with embedded RFID TAG* and NO TAG



OPEN END - inches	TAG	NO TAG
Drive 9x12 Open End 1/4"	615 936 229 0	615 397 069 0
Drive 9x12 Open End 5/16"	615 936 230 0	615 397 070 0
Drive 9x12 Open End 3/8"	615 936 231 0	615 397 071 0
Drive 9x12 Open End 7/16"	615 936 232 0	615 397 072 0
Drive 9x12 Open End 1/2"	615 936 233 0	615 397 073 0
Drive 9x12 Open End 9/16"	615 936 234 0	615 397 074 0
Drive 9x12 Open End 5/8"	615 936 235 0	615 397 075 0
Drive 9x12 Open End 11/16"	615 936 236 0	615 397 076 0
Drive 9x12 Open End 3/4"	615 936 237 0	615 397 077 0
Drive 14x18 Open End 7/16"	615 221 008 0	615 397 145 0
Drive 14x18 Open End 1/2"	615 221 009 0	615 397 146 0
Drive 14x18 Open End 9/16"	615 221 010 0	615 397 147 0
Drive 14x18 Open End 5/8"	615 221 011 0	615 397 148 0
Drive 14x18 Open End 11/16"	615 221 012 0	615 397 149 0
Drive 14x18 Open End 3/4"	615 221 013 0	615 397 150 0
Drive 14x18 Open End 13/16"	615 221 014 0	615 397 151 0
Drive 14x18 Open End 7/8"	615 221 015 0	615 397 152 0
Drive 14x18 Open End 15/16"	615 221 016 0	615 397 153 0
Drive 14x18 Open End 1"	615 221 017 0	615 397 154 0
Drive 14x18 Open End 1,1/8"	615 221 018 0	615 397 172 0

RING BOX END - inches	TAG	NO TAG
Drive 9x12 Ring Box End 1/4"	615 936 238 0	615 397 092 0
Drive 9x12 Ring Box End 5/16"	615 936 239 0	615 397 093 0
Drive 9x12 Ring Box End 3/8"	615 936 240 0	615 397 094 0
Drive 9x12 Ring Box End 7/16"	615 936 241 0	615 397 095 0
Drive 9x12 Ring Box End 1/2"	615 936 242 0	615 397 096 0
Drive 9x12 Ring Box End 9/16"	615 936 243 0	615 397 097 0
Drive 9x12 Ring Box End 5/8"	615 936 244 0	615 397 098 0
Drive 9x12 Ring Box End 11/16"	615 936 245 0	615 397 099 0
Drive 9x12 Ring Box End 3/4"	615 936 246 0	615 397 100 0
Drive 9x12 Ring Box End 13/16"	615 936 247 0	615 397 101 0
Drive 9x12 Ring Box End 7/8"	615 936 248 0	615 397 102 0
Drive 14x18 Box End 1/2"	615 221 019 0	615 397 189 0
Drive 14x18 Box End 9/16"	615 221 020 0	615 397 190 0
Drive 14x18 Box End 5/8"	615 221 021 0	615 397 191 0
Drive 14x18 Box End 11/16"	615 221 022 0	615 397 192 0
Drive 14x18 Box End 3/4"	615 221 023 0	615 397 193 0
Drive 14x18 Box End 13/16"	615 221 024 0	615 397 194 0
Drive 14x18 Box End 7/8"	615 221 025 0	615 397 195 0
Drive 14x18 Box End 15/16"	615 221 026 0	615 397 196 0
Drive 14x18 Box End 1"	615 221 027 0	615 397 197 0



FLARED END - inches	TAG	NO TAG
Drive 9x12 Flared End 3/8"	615 221 001 0	615 397 115 0
Drive 9x12 Flared End 7/16"	615 221 002 0	615 397 116 0
Drive 9x12 Flared End 1/2"	615 221 003 0	615 397 117 0
Drive 9x12 Flared End 9/16"	615 221 004 0	615 397 118 0
Drive 9x12 Flared End 5/8"	615 221 005 0	615 397 119 0
Drive 9x12 Flared End 11/16"	615 221 006 0	615 397 120 0
Drive 9x12 Flared End 3/4"	615 221 007 0	615 397 121 0

REVERSIBLE RATCHET	TAG	NO TAG
Drive 9x12 Reversible ratchet 1/4"	615 936 191 0	615 397 125 0
Drive 9x12 Reversible ratchet 3/8"	615 936 192 0	615 397 126 0
Drive 9x12 Reversible ratchet 1/2"	615 936 193 0	615 397 127 0
Drive 14x18 Reversible ratchet 1/2"	615 936 224 0	615 397 200 0
Drive 14x18 Reversible ratchet Hd 3/4"	615 936 440 0	615 936 439 0
Drive 21x26 Reversible ratchet 3/4"	615 936 442 0	615 936 441 0
Drive Ø 28 Reversible ratchet 1"	615 936 227 0	615 397 204 0



BITS HOLDER	TAG	NO TAG
Drive 9x12 Bits Holder 1/4"	615 221 028 0	615 397 128 0
Drive 9x12 Bits Holder 5/16"	615 221 029 0	615 397 129 0
Drive 14x18 Bits Holder 5/16"	615 221 030 0	615 397 202 0

FIXED SQUARE DRIVE	TAG	NO TAG
Drive 9x12 Fixed Square Drive 1/4"	-	615 397 122 0
Drive 9x12 Fixed Square Drive 3/8"	-	615 397 123 0
Drive 9x12 Fixed Square Drive 1/2"	-	615 397 124 0
Drive 14x18 Fixed Square Drive 1/2"	-	615 397 198 0
Drive 14x18 Fixed Square Drive 3/4"	-	615 397 199 0

*These accessories fit QShield / DWTA and Delta wrenches

Quality Assurance

Best Practices

Ensure QA in Tightening requires:

- Initial **Tool** verification
- Routine **residual torque** online verification
- Routine & Reactive **dynamic online** verification
- Routine **tool transducer** calibration
- Routine plant **standard calibration**
(in ISO/IEC 17025 Accredited laboratories)
- **Data retention**



Important elements to consider in selecting your Quality Equipments

- List Torque specifications / Quality Control specifications.
- Classification of your joints (Criticality of assembly operations in the Control Plan).
- Processes for tool testing, joint testing and standard calibration equipment.
- Ensure data is collected, maintained and accessible.





Optimized Workstation

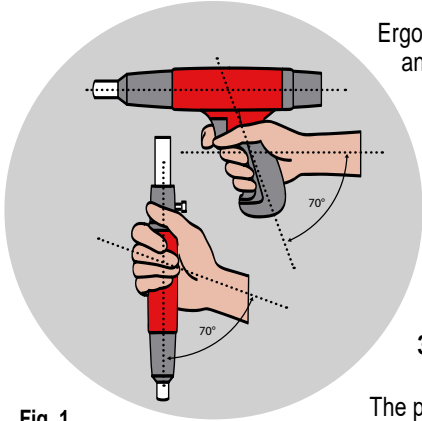

Fig. 1
Holding tools in an ergonomically neutral position

Ergonomics deals with the interactions between operators and their work equipment, work environment and work process

Ergonomically designed work systems enhance safety, effectiveness and efficiency, improve human working and living conditions, and counteract adverse effects on human health and performance

Desoutter has been developing products to improve the comfort of use and counter balance some of the below situations:

1. Hand position on the tool: based on application a straight or pistol grip tool is suggested (Fig. 1)
2. Tool position in the workspace: easy to reach and at the right height to minimize the unnecessary movement of the operator (Fig. 2 and 3)
3. Forces exerted: pulling force, torque reaction and the repetitiveness of these forces (Fig. 2 and 3)

The potential benefits of using Desoutter ergonomic accessories together with tools as described in this brochure are:

- Reduce repetitive stress injuries (RSI)
- Reduced operator fatigue
- Greater productivity
- Improved quality
- Reduced handling time
- Greater operator satisfaction
- Lower recruitment costs

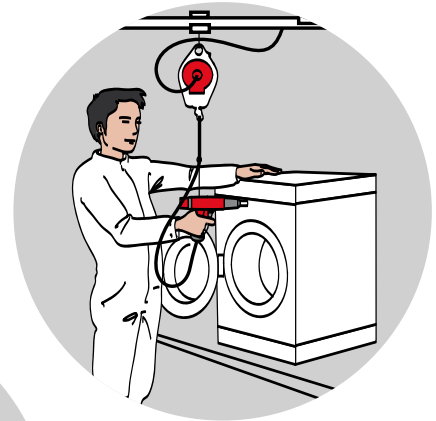

Fig. 2
Desoutter balancer

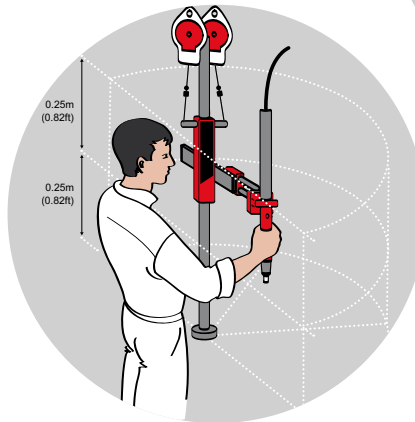
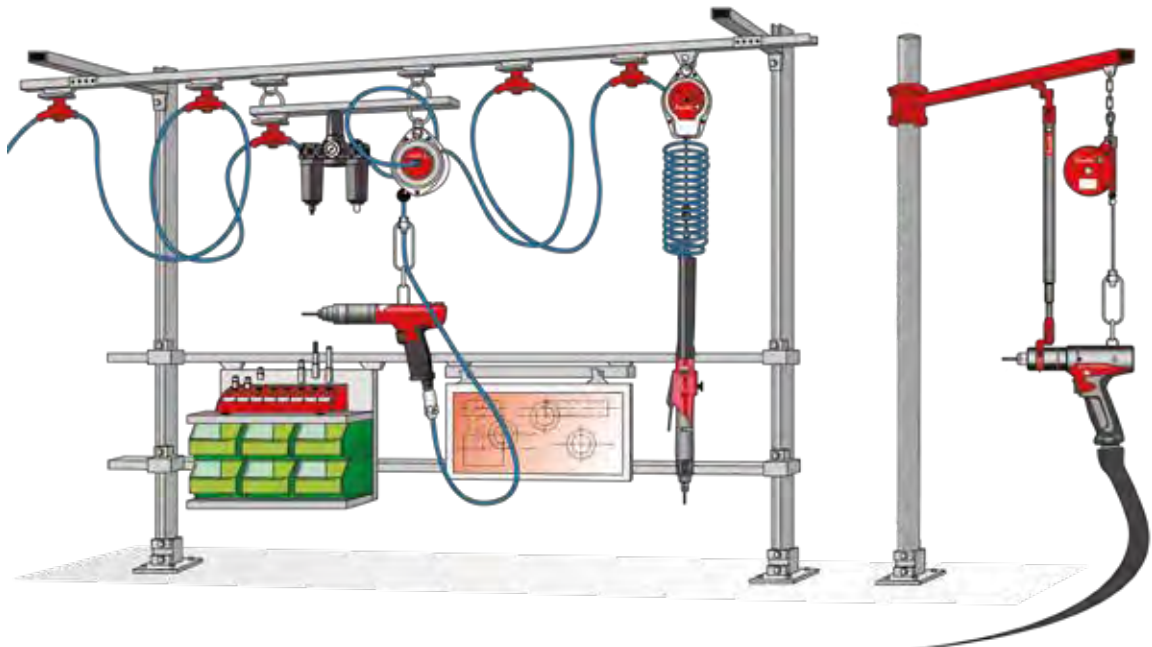
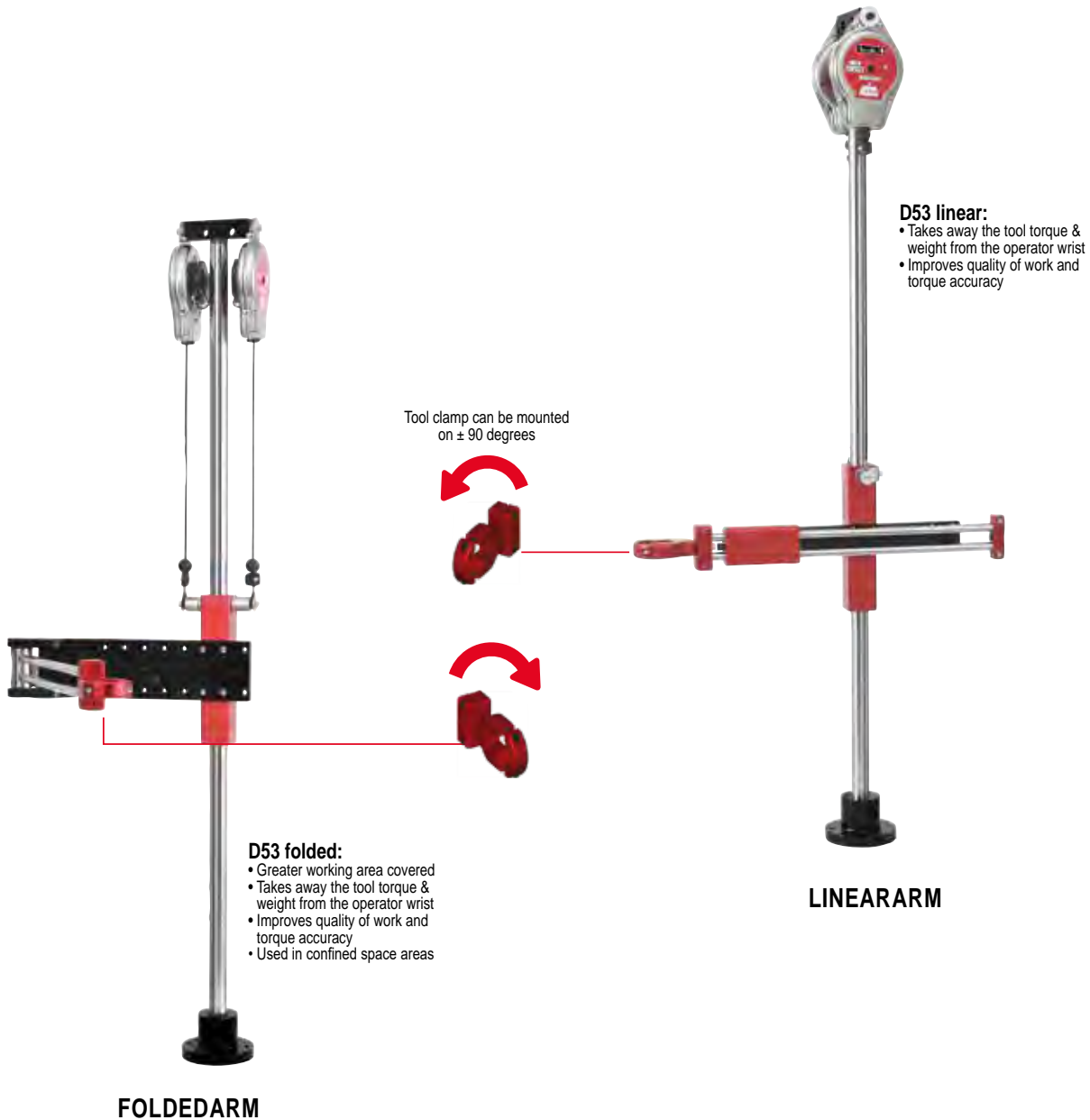

Fig.3
Desoutter torque reaction arm



Linear and Folded torque reaction arms



For full tool clamp program, please see details on page 194

MODEL	PART NUMBER	MAXIMUM TORQUE		MAXIMUM TOOL WEIGHT		ARM EQUIPPED WITH	TOOL CLAMP DIAMETER (INCLUDED WITH THE ARM)	
		Nm	ft. lb.	kg	lb.		mm	in.
LINEAR ARM								
D53-5*	615 810 700 0	5	3.7	0.8	1.8	1 x 5DU	28.5 - 41	1.12 - 1.62
D53-12*	615 810 701 0	12	8.8	1.5	3.3	2 x 5DU	28.5 - 41	1.12 - 1.62
D53-25*	615 810 702 0	25	18.4	2.5	5.5	2 x 5DU	28.5 - 41	1.12 - 1.62
D53-25X Extended reach*	615 810 703 0	25	18.4	2.2	4.8	2 x 5DU	28.5 - 41	1.12 - 1.62
D53-50	615 810 704 0	50	36.8	5.0	11.0	2 x 15D	To order separately	
D53-100	615 810 705 0	100	73.7	6.0	13.2	2 x 22D		
FOLDED ARM								
D53-5S*	615 810 706 0	5	3.7	0.8	1.8	1 x 5DU	28.5 - 41	1.12 - 1.62
D53-12S*	615 810 707 0	12	8.8	1.5	3.3	2 x 5DU	28.5 - 41	1.12 - 1.62
D53-25S*	615 810 708 0	25	18.4	2.5	5.5	2 x 5DU	28.5 - 41	1.12 - 1.62
D53-50S	615 810 709 0	50	36.8	5.0	11.0	2 x 15D	To order separately	
D53-100S	615 810 710 0	100	73.7	6.0	13.2	2 x 22D		

(*) Universal D53 tool clamp included

D53 - Dimensions

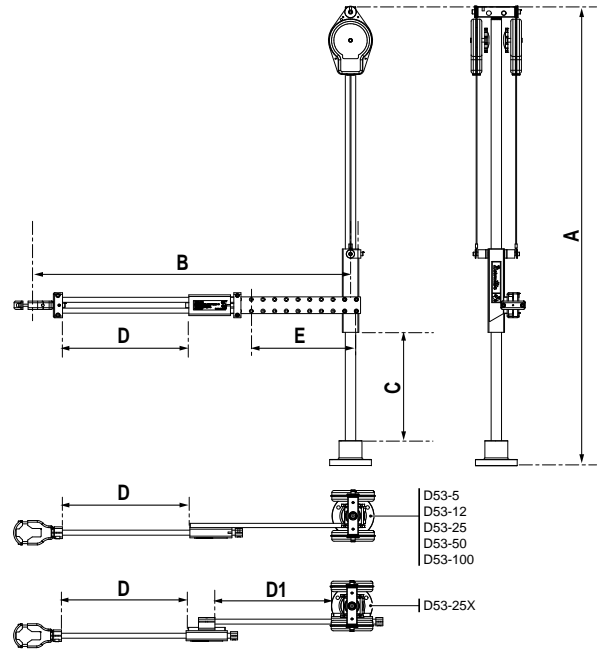
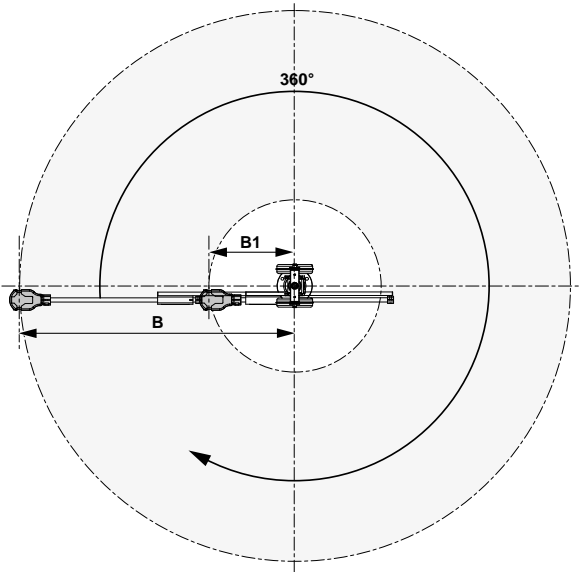

D53 linear working area product specification

MODEL	PART NUMBER	MAXIMUM TORQUE		HEIGHT A		WIDTH				VERTICAL STROKE C		HORIZONTAL STROKE			FIXED STROKE E		TOOL WEIGHT MAX		
		Nm	ft. lb	mm	in	MAXI-B	MINI-B	mm	in	mm	in	mm	in	mm	in	kg	lb		
D53-5	615 810 700 0	5	3.7	732	28.8	592*	23.3*	220*	8.7*	310	12.2	205	8.1	-	-	168	6.6	0.8	1.76
D53-12	615 810 701 0	12	8.9	888	35.0	710*	28*	260*	10.2*	465	18.3	255	10.0	-	-	196	7.7	1.5	3.3
D53-25	615 810 702 0	25	18.4	1132	44.6	779*	30.7*	231*	9.1*	615	24.2	290	11.4	-	-	252	9.9	2.5	5.5
D53-25X	615 810 703 0	25	18.4	1132	44.6	794*	31.2*	230*	9.0*	615	24.2	290	11.4	275	10.8	-	-	2.2	4.85
D53-50	615 810 704 0	50	36.9	1147	45.2	888*	35.0*	267**	10.5**	515	20.3	355	14.0	-	-	266	10.5	5.0	11.0
D53-100	615 810 705 0	100	73.8	1147	45.2	916*	36.0*	255**	10.0**	515	20.3	395	15.6	-	-	266	10.5	6.0	13.2

(* With clamp - (** Without clamp)

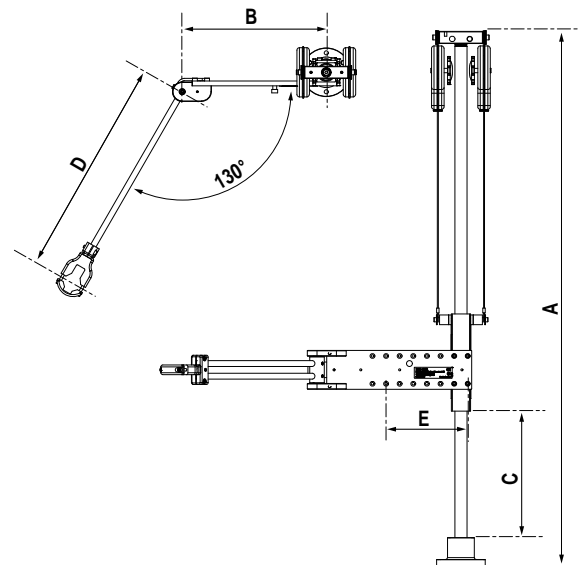
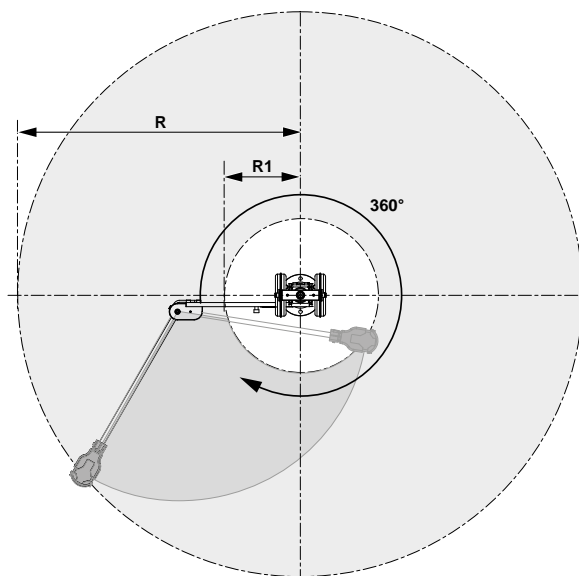

D53 folded working area product specification

MODEL	PART NUMBER	MAXIMUM TORQUE		HEIGHT A		WIDTH B		VERTICAL STROKE C		RADIUS D		FIXED STROKE E		RADIUS R		RADIUS R1		TOOL WEIGHT MAX	
		Nm	ft. lb	mm	in	mm	in	mm	in	mm	in	mm	in	mm	in	mm	in	kg	lb
D53-5S	615 810 706 0	5	3.7	732	28.8	248	9.76	270	10.6	370*	14.6*	168	6.6	546	21.5	140	5.5	0.8	1.76
D53-12S	615 810 707 0	12	8.9	888	35.0	298	11.73	425	16.7	420*	16.5*	168	6.6	639	25.2	146	5.8	1.5	3.3
D53-25S	615 810 708 0	25	18.4	1132	44.6	296	11.65	580	22.8	470*	18.5*	168	6.6	685	27	183	7.2	2.5	5.5
D53-50S	615 810 709 0	50	36.9	1147	45.2	336	1.1	520	20.5	440**	17.3**	228	9.0	698	27.5	154	6.1	5.0	11.0
D53-100S	615 810 710 0	100	73.8	1147	45.2	391	15.4	500	19.7	490**	19.3**	228	9.0	788	31	158	6.2	6.0	13.2

(* With clamp - (** Without clamp)

Linear high torque reaction arms



D53-150/1000 linear:

- High torque arms from 150 to 1000Nm (111 to 740 ft.lb)
- Standard and extended versions

MODEL	PART NUMBER	MAXIMUM TORQUE		MAXIMUM TOOL WEIGHT		BALANCER INCLUDED	TOOL CLAMP DIAMETER
		Nm	ft. lb	kg	lb.		
D53-150	615 811 658 0	150	111	7	15.4	1 x 14DF	To order separately contact your Desoutter representatives
D53-150XL	615 811 659 0	150	111	6	13.2	1 x 14DF	
D53-300	615 811 660 0	300	222	14	30.9	1 x 25DF	
D53-300XL	615 811 661 0	300	222	12.5	27.6	1 x 25DF	
D53-500	615 811 662 0	500	370	30	66.2	1 x 45DF	
D53-500XL	615 811 663 0	500	370	27.4	60.4	1 x 45DF	
D53-1000	615 811 664 0	1000	740	21	46.3	1 x 45DF	
D53-1000XL	615 811 665 0	1000	740	17.8	39.3	1 x 45DF	



D53HT - Dimensions

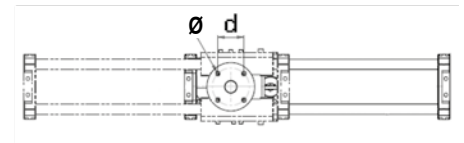
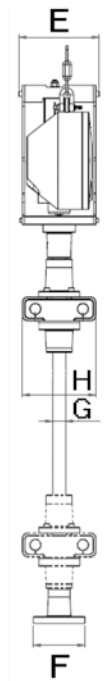
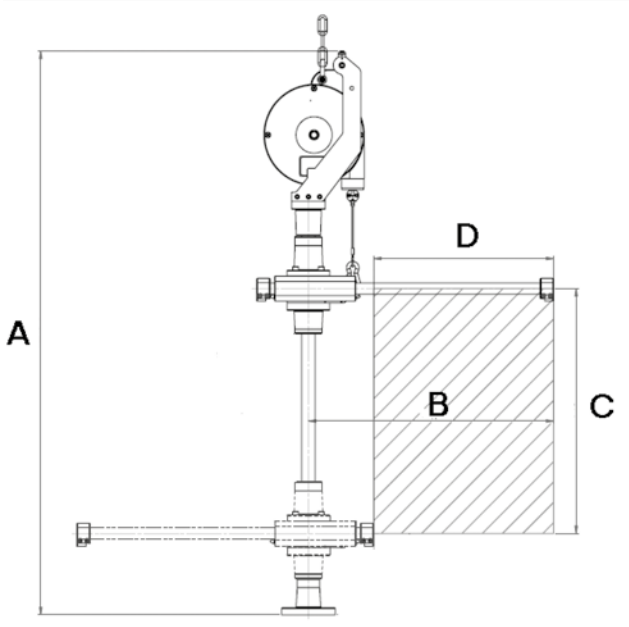

MODEL	PART NUMBER	HEIGHT		WIDTH (WO/CLAMP)				VERTICAL STROKE				TOOL WEIGHT	
		A		MIN-B		MAX-B		MIN-C		MAX-C		kg	lb
		mm	in	mm	in	mm	in	mm	in	mm	in		
D53-150	615 811 658 0	1049	41.3	240	9.4	600	23.6	154.5	6.1	644	25.4	7	15.4
D53-150XL	615 811 659 0	1159	45.6	240	9.4	840	33.1	154.5	6.1	754	29.7	6	13.2
D53-300	615 811 660 0	1216	47.9	260	10.2	660	26.0	180.0	7.1	720	28.3	14	30.9
D53-300XL	615 811 661 0	1296	51	260	10.2	860	33.9	180.0	7.1	780	30.7	12.5	27.6
D53-500	615 811 662 0	1346	53	290	11.4	730	28.7	209.5	8.2	815	32.1	30	66.2
D53-500XL	615 811 663 0	1561	61.5	290	11.4	1090	42.9	209.5	8.2	1009	39.7	27.4	60.4
D53-1000	615 811 664 0	1556	61.3	320	12.6	800	31.5	278.5	11.0	968	38.1	21	46.3
D53-1000XL	615 811 665 0	1691	66.6	320	12.6	1120	44.1	278.5	11.0	1078	42.5	18	39.3

MODEL	HORIZONTAL STROKE									
	D		E		F		G		H	
	mm	in	mm	in	mm	in	mm	in	mm	in
D53-150	360	14.4	170	6.7	90	3.5	25	1.0	150	5.9
D53-150XL	600	24	170	6.7	90	3.5	25	1.0	150	5.9
D53-300	400	16	186	7.3	119	4.7	30	1.2	170	6.7
D53-300XL	600	24	186	7.3	119	4.7	30	1.2	170	6.7
D53-500	440	17.6	180	7.1	119	4.7	40	1.6	170	6.7
D53-500XL	800	32	180	7.1	119	4.7	40	1.6	170	6.7
D53-1000	480	19.2	182	7.2	129	5.1	50	2.0	220	8.7
D53-1000XL	800	32	182	7.2	129	5.1	50	2.0	220	8.7

MODEL	D		Ø		ARM WEIGHT	
	mm	in	mm	in	kg	lb
D53-150	50	2.0	11	0.4	12.5	27.6
D53-150XL	50	2.0	11	0.4	13.7	30.2
D53-300	65	2.6	11	0.4	26.7	58.9
D53-300XL	65	2.6	11	0.4	28.2	62.2
D53-500	65	2.6	11	0.4	40.9	90.2
D53-500XL	65	2.6	11	0.4	43.7	96.3
D53-1000	72	2.8	13.5	0.5	57.9	127.7
D53-1000XL	72	2.8	13.5	0.5	61.5	135.7



D53 X/Y - Positioning arms for Posco 500

- D53 X/Y stands allows to track the tool position during assembly process
- Same tool stand as D53 standard one
- 2 different versions with encoders
- This arm is intended to be used together with our POSCO 500 to program a complete fastening sequence
- Linear arm: Linear/Angular/Encoders
- Swivel arm: Angular/Angular/Encoders

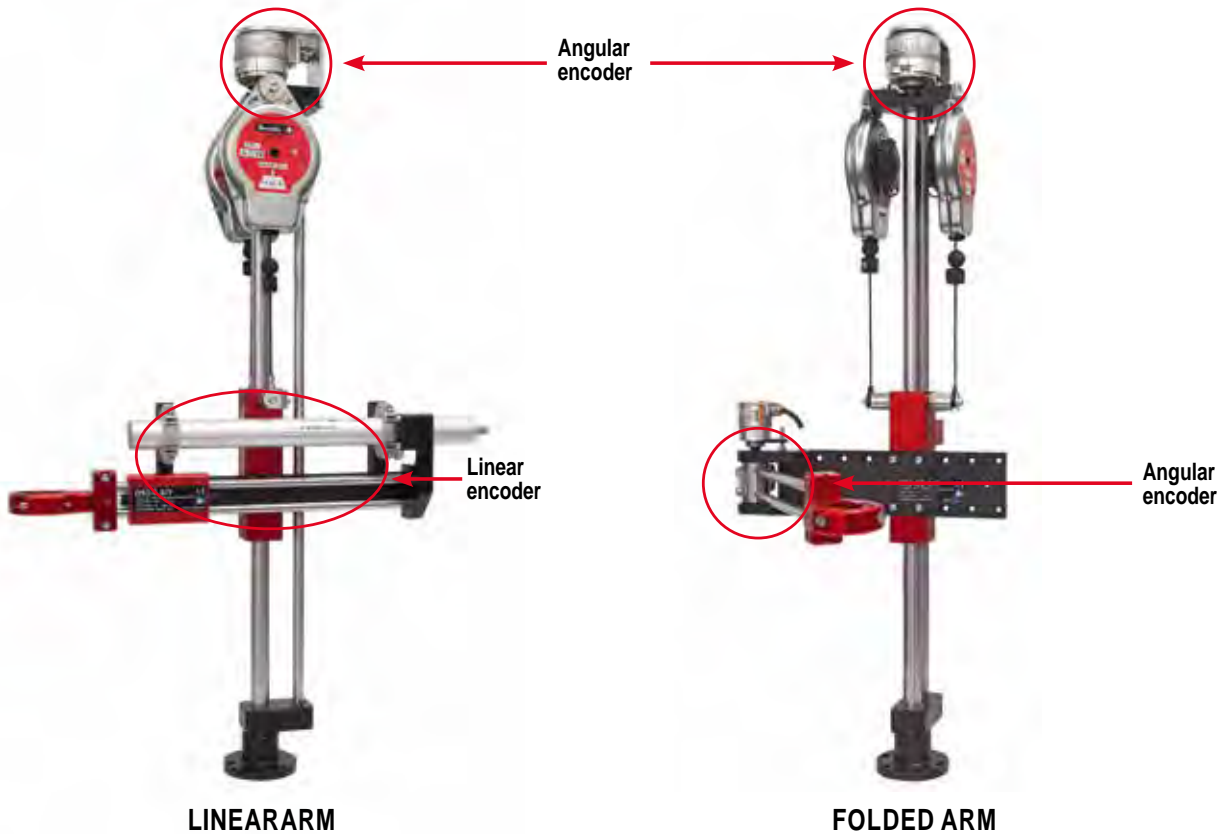

For full tool clamp program, please see details on page 194

MODEL	PART NUMBER	MAXIMUM TORQUE		MAXIMUM TOOL WEIGHT		ARM EQUIPPED WITH	TOOL CLAMP DIAMETER (INCLUDED WITH THE ARM)	
		Nm	ft.lb	kg	lb.		mm	in.
LINEAR ARM								
D53-5 X/Y AXLE*	615 397 874 0	5	3.7	0.8	1.8	1 x 5DU	28.5 - 41	1.12 - 1.62
D53-12 X/Y AXLE*	615 397 875 0	12	8.8	1.5	3.3	2 x 5DU	28.5 - 41	1.12 - 1.62
D53-25 X/Y AXLE*	615 397 876 0	25	18.4	2.5	5.5	2 x 5DU	28.5 - 41	1.12 - 1.62
D53-50 X/Y AXLE*	615 397 877 0	50	36.8	5.0	11.0	2 x 15D	To order separately	
D53-100 X/Y AXLE*	615 397 878 0	100	73.7	6.0	13.2	2 x 22D		
FOLDED ARM								
D53-5S X/Y AXLE*	615 397 879 0	5	3.7	0.8	1.8	1 x 5DU	28.5 - 41	1.12 - 1.62
D53-12S X/Y AXLE*	615 397 880 0	12	8.8	1.5	3.3	2 x 5DU	28.5 - 41	1.12 - 1.62
D53-25S X/Y AXLE*	615 397 881 0	25	18.4	2.5	5.5	2 x 5DU	28.5 - 41	1.12 - 1.62
D53-50S X/Y AXLE	615 397 882 0	50	36.8	5.0	11.0	2 x 15D	To order separately	
D53-100S X/Y AXLE	615 397 883 0	100	73.7	6.0	13.2	2 x 22D		

(*) Universal D53 tool clamp included



D53 X/Y - Dimensions

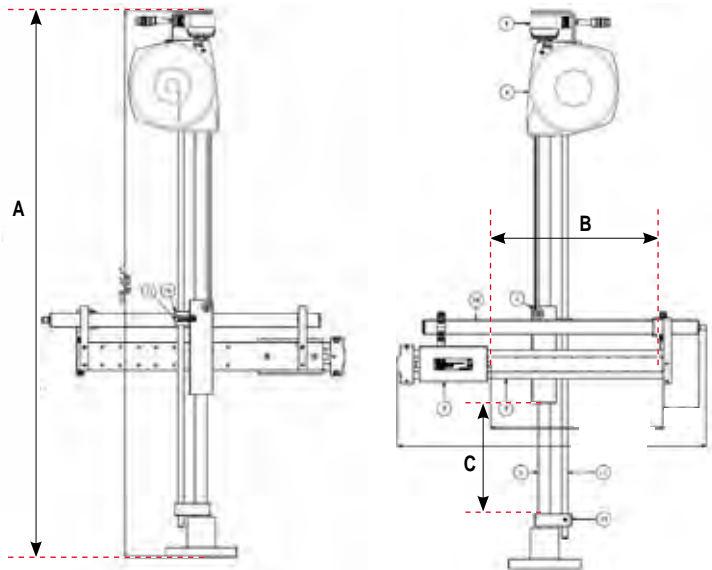
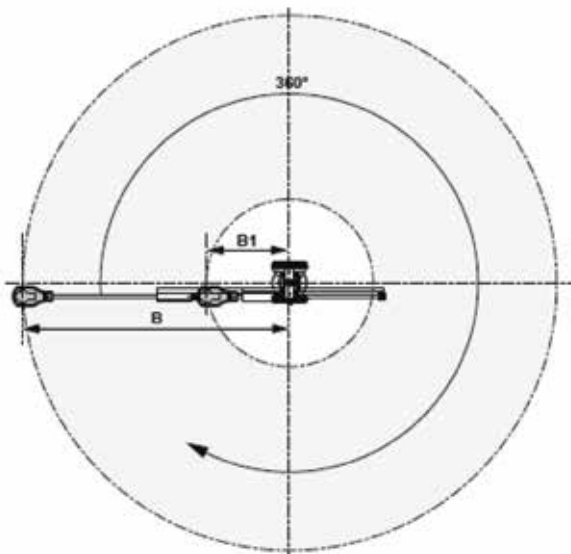

Linear arm

MODEL	PART NUMBER	A		B		C	
		mm	in.	mm	in.	mm	in.
D53-5 X/Y-AXLE	615 397 874 0	789	31.1	206.5	8.1	281	11.1
D53-12 X/Y-AXLE	615 397 875 0	945	37.2	238.5	9.4	436	17.2
D53-25 X/Y-AXLE	615 397 876 0	1189	46.8	291.5	11.5	586	23.1
D53-50 X/Y-AXLE	615 397 877 0	1189	46.8	259.5	10.2	486	19.1
D53-100 X/Y-AXLE	615 397 878 0	1189	46.8	398.5	15.7	486	19.1

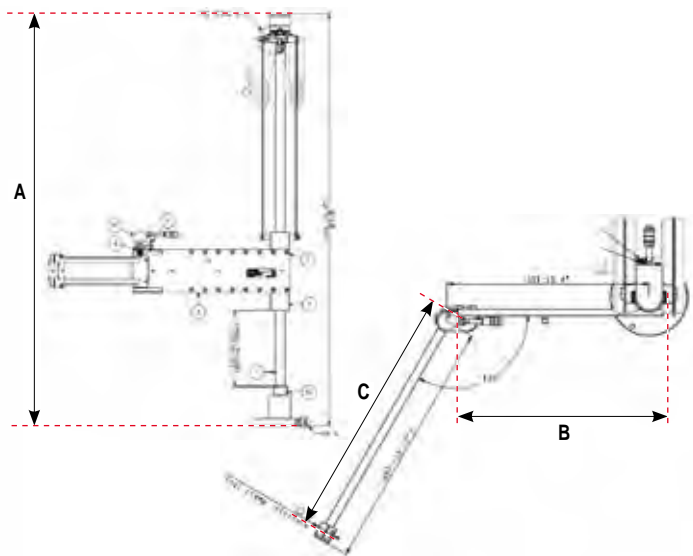
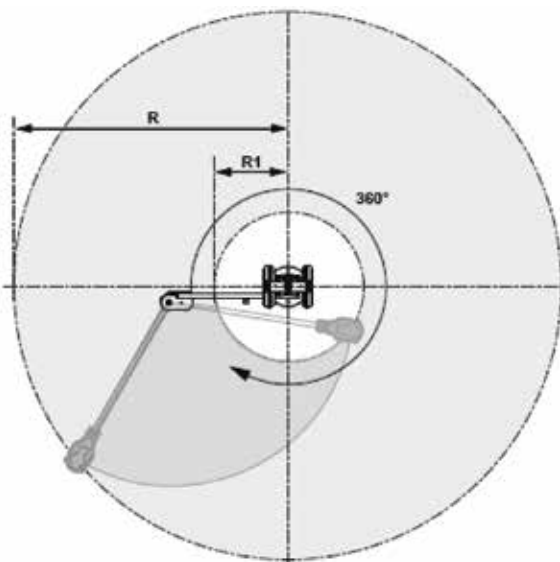

Folded arm

MODEL	PART NUMBER	A		B		C		R		R1	
		mm	in.	mm	in.	mm	in.	mm	in.	mm	in.
D53-5S X/Y AXLE	615 397 879 0	789	31.1	248	9.8	370	14.6	546	21.5	140	5.5
D53-12S X/Y AXLE	615 397 880 0	945	37.2	298	11.7	420	16.5	639	25.2	146	5.8
D53-25S X/Y AXLE	615 397 881 0	1158	45.6	296	11.6	470	18.5	685	27	183	7.2
D53-50S X/Y AXLE	615 397 882 0	1158	45.6	336	13.2	440	17.3	698	27.5	154	6.1
D53-100S X/Y AXLE	615 397 883 0	1158	45.6	391	15.4	490	19.3	788	31	158	6.2

D53 X/Y – Positioning arms for CVI3

- D53 X/Y CANopen stands allows to track the tool position during assembly process
- Same tool stand as D53 standard one
- 2 different versions with encoders
- This arm is intended to be used together with our CVI3 controller
- Connected directly to the CVI3 controller
- Needs ePOD 2 or higher
- Easy positioning learning mode

ACCESSORIES NEEDED :

- 1** Cable adaptor EBUS M12 / SUBD9 6159176630
- 2** Select one of them :
 - eBUS SUBD9 cable 3m 6159176080
 - eBUS SUBD9 cable 5m 6159176090
 - eBUS SUBD9 cable 15m 6159176100
- 3** Select one ePOD :
 - ePOD2 6159360760
 - ePOD3 6159360770

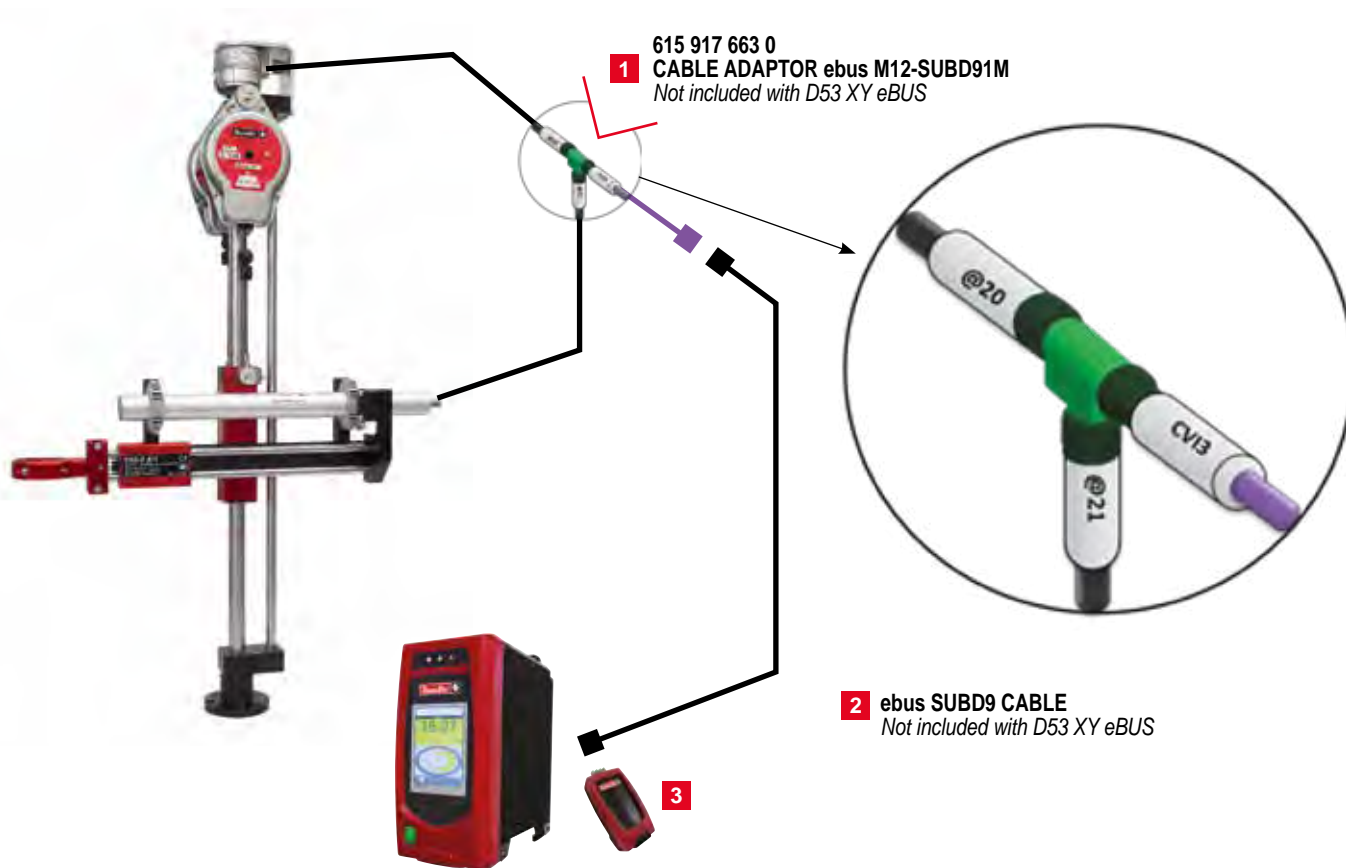

1 615 917 663 0
CABLE ADAPTOR ebus M12-SUBD91M
Not included with D53 XY eBUS

2 ebus SUBD9 CABLE
Not included with D53 XY eBUS

3

MODEL	PART NUMBER	MAXIMUM TORQUE		MAXIMUM TOOL WEIGHT		ARM EQUIPPED WITH	TOOL CLAMP DIAMETER (INCLUDED WITH THE ARM)	
		Nm	ft. lb	kg	lb.		mm	in.
LINEAR ARM								
D53-5 X/Y-AXLE EBUS	615 812 267 0	5	3.7	0.8	1.8	1 x 5DU	28.5 - 41	1.12 - 1.62
D53-12 X/Y-AXLE EBUS	615 812 268 0	12	8.8	1.5	3.3	2 x 5DU	28.5 - 41	1.12 - 1.62
D53-25 X/Y-AXLE EBUS	615 812 269 0	25	18.4	2.5	5.5	2 x 5DU	28.5 - 41	1.12 - 1.62
D53-50 X/Y-AXLE EBUS	615 812 270 0	50	36.8	5.0	11.0	2 x 15D	To order separately	
D53-100 X/Y-AXLE EBUS	615 812 271 0	100	73.7	6.0	13.2	2 x 22D		
FOLDED ARM								
D53-5S X/Y-AXLE EBUS	615 812 272 0	5	3.7	0.8	1,8	1 x 5DU	28.5 - 41	1.12 - 1.62
D53-12S X/Y-AXLE EBUS	615 812 273 0	12	8.8	1.5	3,3	2 x 5DU	28.5 - 41	1.12 - 1.62
D53-25S X/Y-AXLE EBUS	615 812 274 0	25	18.4	2.5	5.5	2 x 5DU	28.5 - 41	1.12 - 1.62
D53-50S X/Y-AXLE EBUS	615 812 275 0	50	36.8	5.0	11.0	2 x 15D	To order separately	
D53-100S X/Y-AXLE EBUS	615 812 276 0	100	73.7	6.0	13.2	2 x 22D		

D53 X/Y – Positioning arms for CVI3

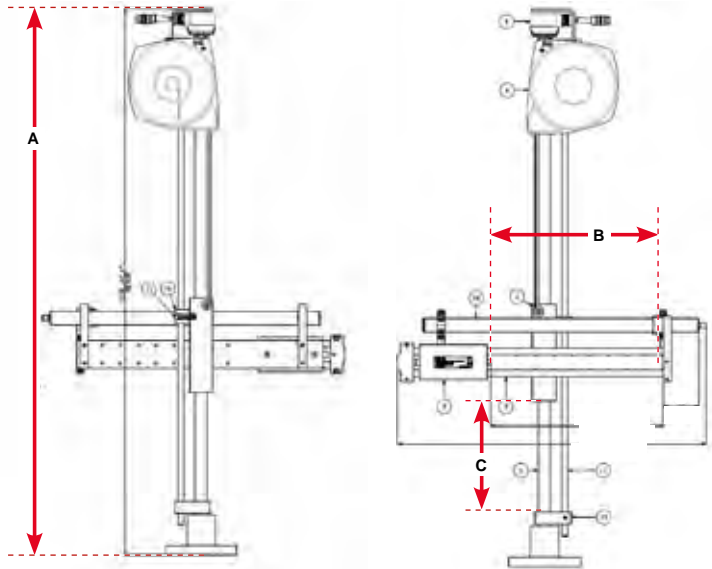
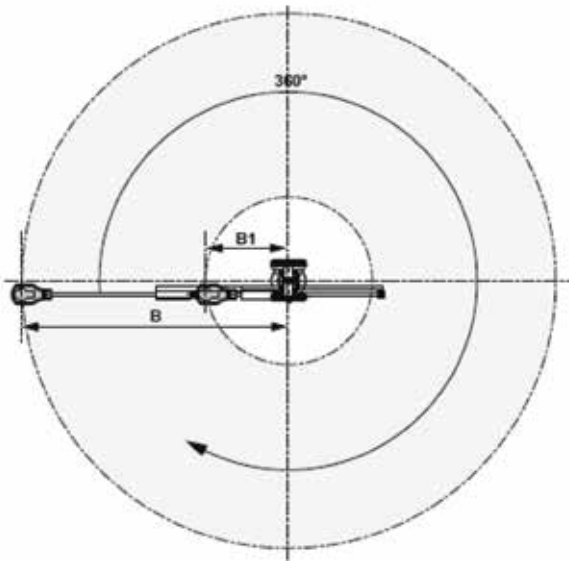

Linear arm

MODEL	PART NUMBER	A		B		C	
		mm	in.	mm	in.	mm	in.
D53-5 X/Y-AXLE EBUS	615 812 267 0	789	31.1	205	8.1	281	11.1
D53-12 X/Y-AXLE EBUS	615 812 268 0	945	37.2	255	10	436	17.2
D53-25 X/Y-AXLE EBUS	615 812 269 0	1158	45.6	290	11.4	586	23.1
D53-50 X/Y-AXLE EBUS	615 812 270 0	1158	45.6	355	14	486	19.1
D53-100 X/Y-AXLE EBUS	615 812 271 0	1158	45.6	395	15.6	486	19.1

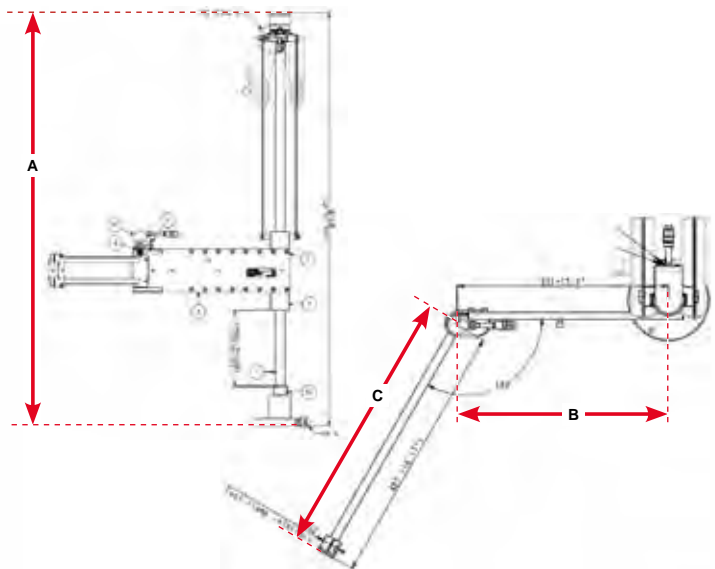
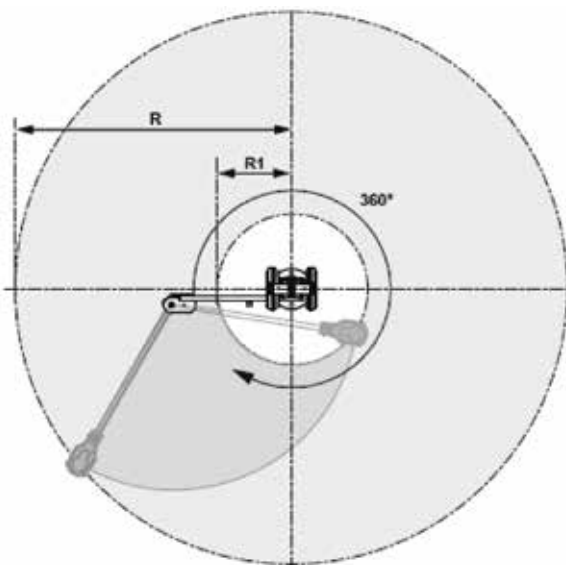

Folded arm

MODEL	PART NUMBER	A		B		C		R		R1	
		mm	in.	mm	in.	mm	in.	mm	in.	mm	in.
D53-5S X/Y-AXLE EBUS	615 812 272 0	789	31.1	248	9.8	292	11.5	489	19.3	140	5.5
D53-12S X/Y-AXLE EBUS	615 812 273 0	945	37.2	298	11.7	342	13.5	575	22.6	146	5.8
D53-25S X/Y-AXLE EBUS	615 812 274 0	1158	45.6	296	11.6	392	15.5	621	24.5	183	7.2
D53-50S X/Y-AXLE EBUS	615 812 275 0	1158	45.6	336	13.2	440	17.3	698	27.5	154	6.1
D53-100S X/Y-AXLE EBUS	615 812 276 0	1158	45.6	391	15.4	490	19.3	788	31	158	6.2

Tool clamp guide for D53 arms

Ordering Process:

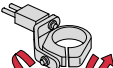
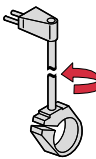
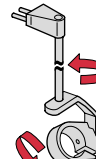
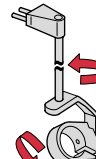
SELECT YOUR TOOL	SELECT THE ARM ACCORDING TO: - THE TORQUE APPLICATION - THE REACH NEEDED		ADD THE TOOL CLAMP IF NOT INCLUDED WITH THE ARM				ADD ADAPTORS IF YOU USE ROTATION CLAMPS	
STEP 1	STEP 2		STEP 3				STEP 4	
TOOL MODEL	D53 MODELS		TOOL CLAMP REFERENCES				COMMENTS	
	Linear arms	Swiveling arms	Universal Clamp	Spline	Vertical 2 axis rotation clamp Only for D53-12(S) and D53-25(S)	Horizontal 1 axe rotation clamp Only for D53-12(S) and D53-25(S)	Horizontal 2 axis rotation clamp Only for D53-12(S) and D53-25(S)	
SB/SBP/SC2/SC/ SCP(T)SH70 SLBN SLC(P) Nose mount ECS/ERS/ECD 5	D53-5* / D53-12* / D53-25* * Tool clamp included	D53-5S* / D53-12S* / D53-25S* * Tool clamp included						
SD/SDP/SDT ERP 3/5/10/20 ECP 3/5/10/20	D53-5* / D53-12* / D53-25* * Tool clamp included	D53-5S* / D53-12S* / D53-25S* * Tool clamp included	615 810 835 0 Included (A) 28.5-41mm		615 396 615 0 + 409083 NOT Included To be ordered	615 396 615 0 + 409113 NOT Included To be ordered	615 396 615 0 + 409173 NOT Included To be ordered	SD Top mount: adaptor ref. 409273 To be ordered with rotation clamps SD Nose mount: 465463 for 320-1470rpm / 465443 for 2200- 3500rpm - To be ordered with rotation clamps
SLC Top mount	D53-5 / D53-12	D53-5S D53-12S	615 810 838 0 NOT Included To be ordered (B) 40-50 mm		615 396 615 0 + 409093 NOT Included To be ordered	615 396 615 0 + 409123 NOT Included To be ordered	615 396 615 0 + 409183 NOT Included To be ordered	
ECA 15/20/30	D53-5 D53-12 D53-25	D53-5S D53-12S D53-25S	615 810 838 0 NOT Included To be ordered (B) 40-50 mm					
SH 150/200/280/420/500 SH 700/850 ERP 30/40 ERAL1.5/2 ECS/ERS	D53-25(X) D53-50 D53-100	D53-25S(X) D53-50S D53-100S		615 811 029 0 NOT Included To be ordered (B) 28-55 mm				
ERDL 4 ECD 50/70/120	D53-50 / D53-100	D53-50S D53-100S		615 810 203 0 NOT Included To be ordered (C)				
EID 44-1200 EID 75-900 EID 65-800	D53-50 / D53-100	D53-50S D53-100S		615 812 136 0 NOT Included To be ordered (C)				
ERDL 6	D53-100	D53-100S		615 810 205 0 NOT Included To be ordered (C)				
ECD20/30	D53-25(X) D53-50	D53-25S(X) D53-50S		615 810 628 0 + 615 396 191 0 NOT Included To be ordered (D)				Parts to be welded
ERAL 4-90/110/120 ERAL 6-135 ECA 70... 150	D53-100	D53-100S		615 810 628 0 + 615 396 227 0 NOT Included To be ordered (D)				Parts to be welded
EID25-1200 EID 32-900 EDP/ERDL 1.5/2	D53-50	D53-50S		615 810 628 0 + 615 396 551 5 NOT Included To be ordered (D)				Parts to be welded

For the tools not mentioned in this list, please ask your local Desoutter contact to define the tool clamp.

Tool clamps



A



B



C



D



E

Specific Clamps

MODEL E	PART NUMBER
SD SH70/150/200/280/420/500	615 810 129 0

D53 Tool positioning

Straight tool



Pistol grip tool



Angle nutrunner



TRA - Telescopic reaction arms

Telescopic carbon arm: Ideal for busy workspace!

- From 12 up to 200 Nm (8.9 up to 148 ft.lb) torque capacity
- Several lengths available
- 90 degrees tool clamp interface for straight or pistol grip tools
- Limited tool clamp angle rotation to avoid side forces in the operator arm ($\dot{\omega}$) (Fig 1)

Benefits:

- Extremely lightweight carbon made torque arm for improved comfort of use
- Flexible solution

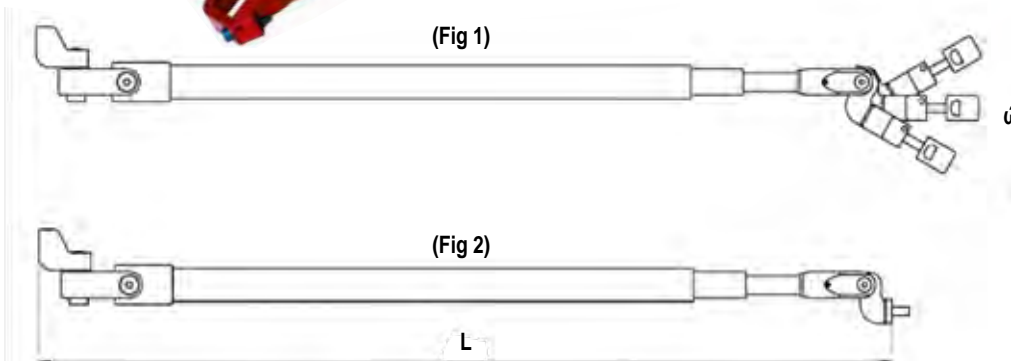

B



C

** Universal balancer adapter

OPTIONAL ACCESSORIES

ITEM	DESCRIPTION	PART NUMBER
A	Bench stand Ø 32mm (1.26") - H 753mm (29.64")	615 810 194 0
B	Bench stand holder Ø 32mm (1.26") for TRA 12/25	615 810 121 0
B	Bench stand holder Ø 32mm (1.26") for TRA 50/100	615 810 140 0
C	Universal balancer adapter	615 397 922 5

MODEL	PART NUMBER	MAXIMUM TORQUE		MAX. MIN LENGTH L		$\dot{\omega}$ (DEG)	WEIGHT		TOOL CLAMP DIAMETER (INCLUDED WITH THE ARM)	
		Nm	ft. lb	mm	in.		kg	lb	mm	in.
TRA12 1150*	615 810 089 0	12	8.9	516-1128	20-44	170	0.46	1.01	28-49	1.10-1.92
TRA12 1600*	615 810 090 0	12	8.9	666-1578	26-62	170	0.51	1.12	28-49	1.10-1.92
TRA12 2100*	615 810 091 0	12	8.9	835-2083	32-82	170	0.57	1.26	28-49	1.10-1.92
TRA25 1150*	615 810 092 0	25	18.4	524-1124	20-44	170	0.60	1.32	28-49	1.10-1.92
TRA25 1600*	615 810 093 0	25	18.4	674-1574	26-62	170	0.70	1.54	28-49	1.10-1.92
TRA25 2100*	615 810 094 0	25	18.4	841-2075	33-82	170	0.77	1.70	28-49	1.10-1.92
TRA25 2600*	615 810 095 0	25	18.4	1007-2573	39-101	170	0.86	1.89	28-49	1.10-1.92
TRA50 1600*	615 810 096 0	50	36.9	712-1624	28-64	40	1.14	2.51	28-50	1.10-1.97
TRA50 2100*	615 810 097 0	50	36.9	878-2125	34-84	40	1.24	2.73	28-50	1.10-1.97
TRA50 2600*	615 810 098 0	50	36.9	1045-2626	41-103	40	1.34	2.95	28-50	1.10-1.97
TRA100 1600	615 810 099 0	100	73.8	722-1628	28-64	30	1.47	3.24	To order separately (see page 200)	
TRA100 2100	615 810 100 0	100	73.8	889-2129	35-83	30	1.41	3.11		
TRA100 2600	615 810 101 0	100	73.8	1056-2630	41-103	30	1.53	3.37		
TRA200 1600	615 810 102 0	200	148	726-1628	28-64	20	1.98	4.36		
TRA200 2100	615 810 103 0	200	148	893-2129	35-84	20	2.18	4.80		
TRA200 2600	615 810 104 0	200	148	1060-2630	41-103	20	2.39	5.27		

(* Universal TRA tool clamp included (** Universal balancer adapters: 1 kit = 7 parts for all Desoutter balancer types: Part No. 615 397 922 5

TRA - Positioning telescopic arms for Posco 500

TRA with positioning system allows to track the tool position during the assembly process

Same telescopic arm as the standard one: from 12 to 200 Nm (8.9 to 148 ft.lb) torque capacity.

- 2 encoders: length measurement + angle control
- This arm is intended to be used together with our POSCO 500 to program a complete fastening sequence
- Accuracy: +/- 5mm



Need to order a balancer separately See page 207



**Universal balancer adapter

2 encoders system

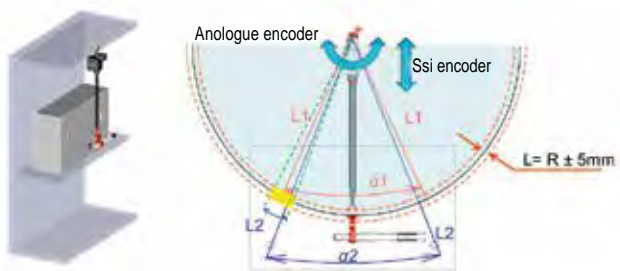

MODEL	PART NUMBER	NUMBER OF ENCODER	MAXIMUM TORQUE		MAX. MIN. LENGTH		TOOL CLAMP DIAMETER	
			Nm	ft.lb	mm	in.	mm	in.
TRA 12 1600 UNI P2 *	615 811 695 0	2	12	8.8	1762	69	28 - 49	1.10 - 1.92
TRA 25 2100 UNI P2 *	615 811 671 0	2	25	18.4	2259	89	28 - 49	1.10 - 1.92
TRA 50 2100 UNI P2 *	615 811 677 0	2	50	36.8	2311	91	28 - 49	1.10 - 1.92
TRA 100 2100 P2	615 811 683 0	2	100	73.7	2315	91	To be ordered separately	
TRA 200 2100 P2	615 811 689 0	2	200	147.4	2317	91	(page 200)	

(*) Universal TRA tool clamp included

(**) Universal balancer adapters: 1 kit = 7 parts for all Desoutter balancer types. Part Nr. 615 397 922 5

TRA X/Y – Positioning arms for CVI3

Same telescopic arms as the standard one: up to 200Nm (148 ft.lb.) torque capacity

- TRA X/Y CANopen arms allows to track the tool position during assembly process
- 2 different versions:
 - 1 encoder: length measurement
 - 2 encoders: length measurement + angle control
- This arm is intended to be used together with our CVI3 controller
- Accuracy: +/- 5mm
- Connected directly to the CVI3 controller
- Needs ePOD 2 or higher
- Easy positioning learning mode

ACCESSORIES NEEDED :

- 1** Cable adaptor EBUS M12 / SUBD9 6159176630
 - 2** Select one of them :
 - eBUS SUBD9 cable 3m 6159176080
 - eBUS SUBD9 cable 5m 6159176090
 - eBUS SUBD9 cable 15m 6159176100
 - 3** Select one ePOD :
 - ePOD2 6159360760
 - ePOD3 6159360770
- Needs ePOD 2 or higher
 - Easy positioning learning mode

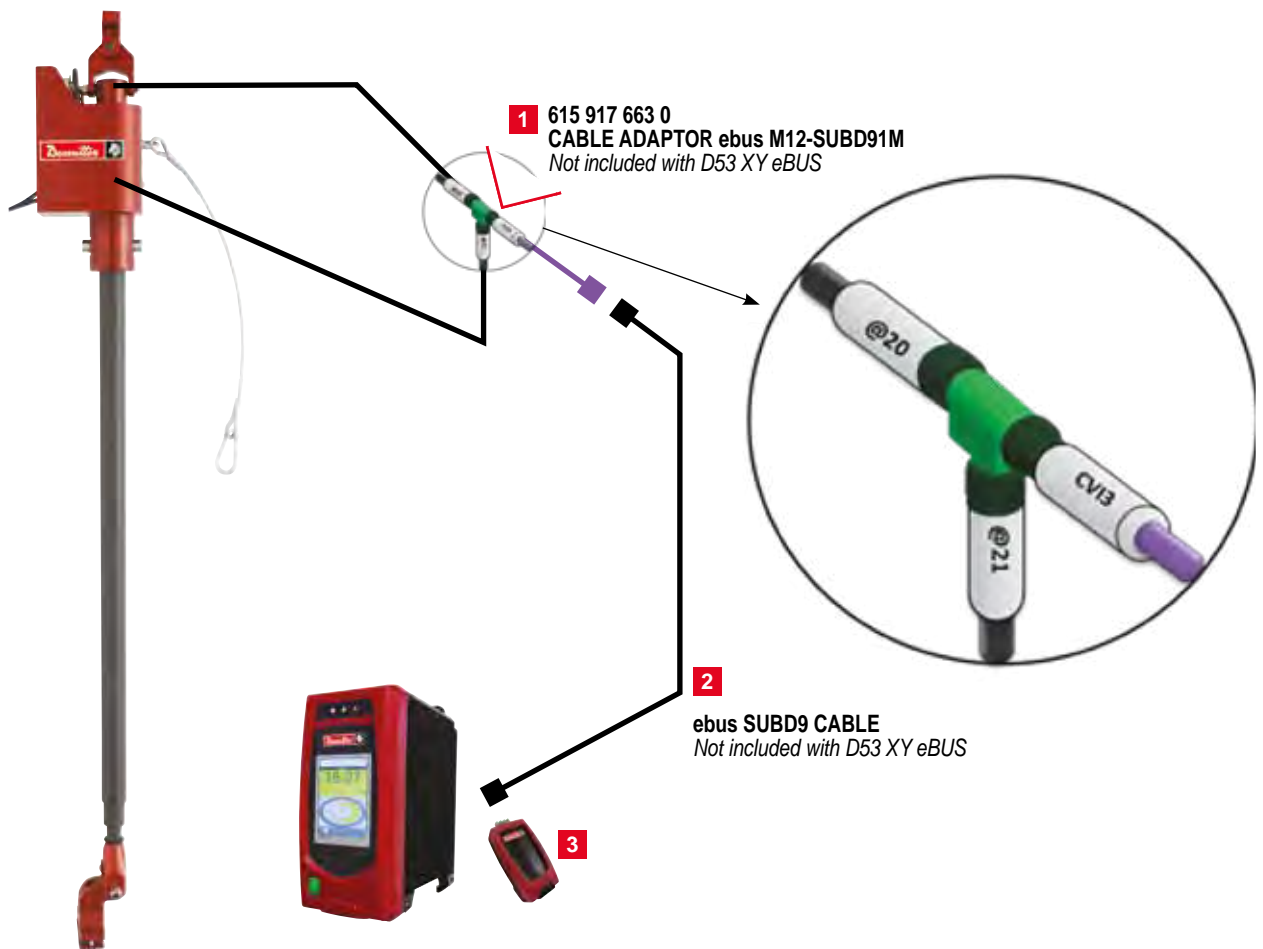

TRA X/Y – Positioning arms for CVI3

MODEL	PART NUMBER	TORQUE MAX		L MIN		L MAX		STROKE		WEIGHT	
		Nm	Ft.lb	mm	in	mm	in	mm	in	kg	lb
TRA 12 1600 P2	615 812 107 0	12	8.9	883.5	34.78	1762	69.4	887.5	34.6	4.2	9.3
TRA 25 2100 P2	615 812 108 0	25	18.4	1053.5	41.47	2259	88.9	1205.5	47.5	4.4	9.7
TRA 50 2100 P2	615 812 109 0	50	36.9	1105	43.5	2311	91	1206	47.5	4.8	10.6
TRA 100 2100 P2	615 812 110 0	100	73.8	1080	42.5	2315	91.15	1235	48.6	5	11
TRA 200 2100 P2	615 812 111 0	200	148	1085	42.7	2317	91.2	1232	48.5	6.8	15

TRA X/Y CANopen - Dimensions

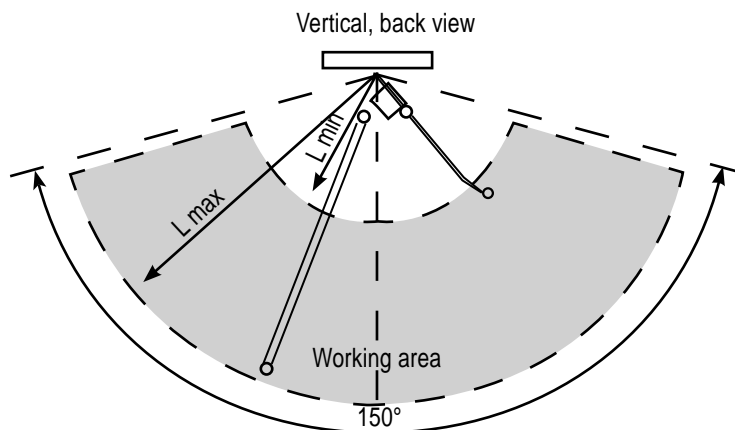
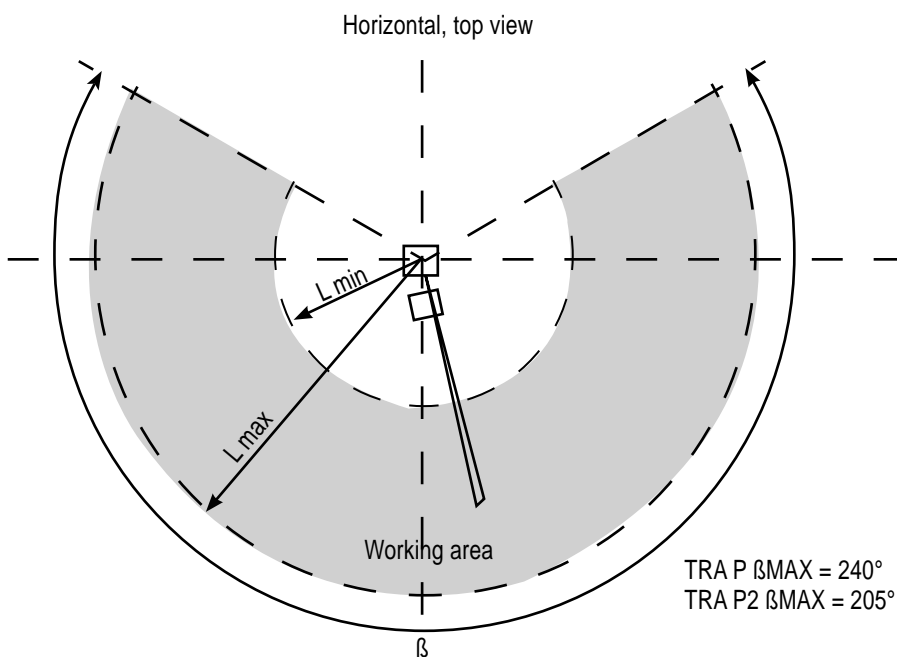

The new clamps guide for TRA

Ordering Process:

SELECT YOUR TOOL	SELECT THE ARM ACCORDING TO: - THE TORQUE APPLICATION - THE REACH NEEDED	ADD THE TOOL CLAMP, IF NOT INCLUDED WITH THE ARM		
STEP 1	STEP 2	STEP 3		
TOOL MODEL	TRA MODEL	TOOL CLAMP REFERENCE	DESCRIPTION	PHOTO
SB/SBP SC2/SCP/SCPT SD/SDP/SDT SH 70/150/200/280 SLBN/SLC/SLCP ECS ERP 3/5/10/20 ECD 5	TRA12* / 25 * * Clamp included with the arm	615 810 118 0 Included with the arm	Universal Clamp 28 - 49mm (1.1 - 1.92")	A
ERP 30/40 ERDL 1,5/2 ERAL 4-90	TRA50* / 100 * Clamp included with the arm	6158101370 Included with TRA50. To be ordered for TRA100	Universal Clamp 28 - 50mm (1.1 - 1.97")	B
SH 420/500	TRA50 TRA100	6158129030 + 6158128940 6158129040 + 6158128940		C
SH 700	TRA50 TRA100	6158129030 + 6158129000 6158129040 + 6158129000		C
SH 850	TRA 100	6158128940 + 6158128970		C
ERAL 1,5/2	TRA50, TRA100	6158129030 + 6158128890 6158129040 + 6158128890		C
ERAL 4	TRA50, TRA100	6158129030 + 6158128960 6158129040 + 6158128960		C
ECA 15/20/30	TRA 50	6158129030 + 6158128930		C
ECA 40/60	TRA 100	6158129040 + 6158128930		C
EAD 20/32 EAB(C) 26/32/45	TRA50	6158129030 + 6158128880		C
EAD 50-900	TRA50 TRA100	6158129030 + 6158128910 6158129040 + 6158128910		C
EAD 70/75/80/95/105 EAB(C) 60	TRA50 TRA100	6158129030 + 6158128950 6158129040 + 6158128950		C
ERDL 4 - 60/80/135 ECD 50/70/120	TRA100 TRA200	6158102030 for TRA100 6158102020 for TRA200 NOT Included with the arm To be ordered	Spline G1 D40,5	D
EID 44/65/75	TRA100	6158121360 for TRA100 NOT Included with the arm To be ordered	Spline G1 D40,5	D
ERDL 6 - 170/220/250	TRA200	6158102040 NOT Included with the arm To be ordered	Spline G1 D50	D
EDP EID 25/32	TRA 50	6158106280 + 6153965515 NOT Included with the arm To be ordered	Clamp to be welded	E
ECD 20/30	TRA 50	6158106280 + 6153961910 NOT Included with the arm To be ordered	Clamp to be welded	E
ECA 70/90/115/125/150	TRA 100	6158129040 + 6158128980		C
ERAL 4 - 225 ECA 200	TRA200	6158106310 + 6153962300 NOT Included with the arm To be ordered	Clamp to be welded	E



For the tools not mentioned in this list, please ask your local Desoutter contact to define the tool clamp

Torque Tubes



Telescopic arm for vertical and horizontal fastening applications

- From 0 to 100 Nm (0 to 73.7ft.lb) torque capacity
- Different strokes available
- Designed to be used with all Desoutter tools
- Gravity center adjustment and rigid fixation as options



MODEL	PART NUMBER	MAX TORQUE		STROKE		WEIGHT	
		Nm	ft lb	mm	in	kg	lb
TT10-850/300	615 812 260 0	12	8.9	300	11.8	1.4	3.1
TT25-1150/300	615 812 082 0	25	18.4	300	11.8	3.5	7.8
TT25-1600/600	615 812 261 0	25	18.4	600	23.6	3,9	8.7
TT50-1700/600	615 812 262 0	50	36.9	600	23.6	5.3	11.7
TT50-2100/900	615 812 263 0	50	36.9	900	35.4	6.3	13.8
TT100-1700/600	615 812 264 0	100	73.7	600	23.6	8.6	18.9
TT100-2100/900	615 812 265 0	100	73.7	900	35.4	10	22

OPTIONAL ACCESSORIES

PART NUMBER	DESCRIPTION	FOR TORQUE TUBE
615 812 203 0	Gravity center adjustment	TT10
615 812 149 0	Gravity center adjustment	TT25
615 812 532 0	Gravity center adjustment	TT50
615 812 539 0	Gravity center adjustment	TT100
615 812 211 0	Rigid fixation	TT10
615 812 157 0	Rigid fixation	TT25
615 812 535 0	Rigid fixation	TT50 / 100
615 812 141 0	Balancer DU fixation	TT10 / 25
615 812 145 0	Balancer D fixation	TT25/50
615 812 522 0	Balancer DF fixation	TT50 / 100

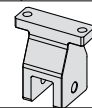
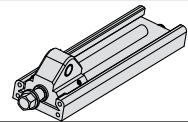

Torque Tubes

WORK AREA

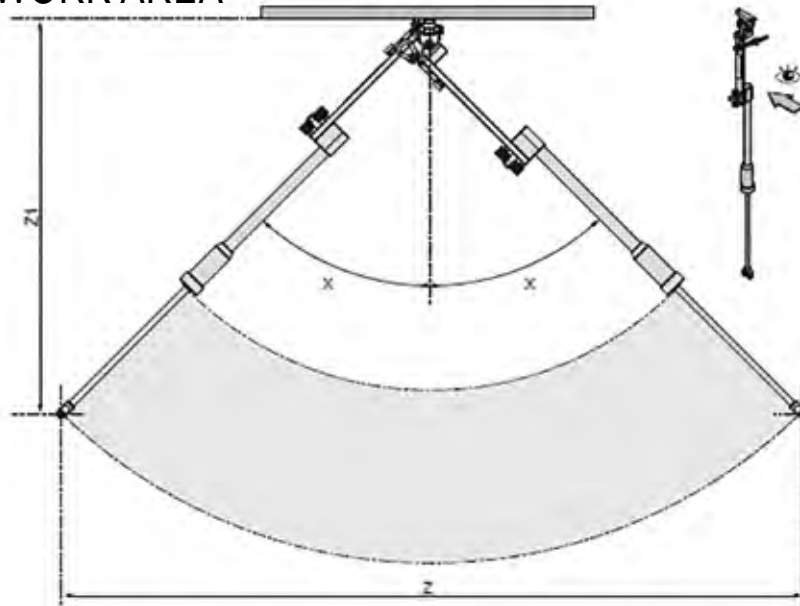

MODEL	PART NUMBER	X	Z MAX ±5		Z1 MAX ±5	
		Deg	mm	in	kg	lb
TT10-850/300	615 812 260 0	45	1378	54.25	723.8	28.5
TT25-1150/300	615 812 082 0	45	1508.4	59.39	819	32.2
TT25-1600/600	615 812 261 0	45	2356.9	92.8	1243.3	48.9
TT50-1700/600	615 812 262 0	45	2552	100.5	1362	53.6
TT50-2100/900	615 812 263 0	45	340.3	13.4	1786.45	70.3
TT100-1700/600	615 812 264 0	45	2583.1	101.7	1377.67	54.2
TT100-2100/900	615 812 265 0	45	3431.6	135.1	1801.94	70.9

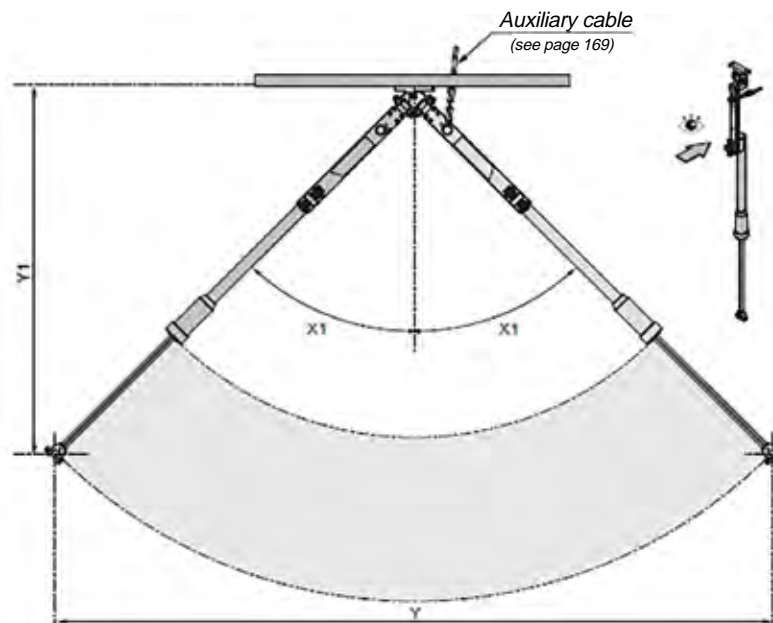

MODEL	PART NUMBER	X	Y MAX ±5		Y1 MAX ±5	
		Deg	mm	in	kg	lb
TT10-850/300	615 812 260 0	45	1403.5	55.3	721.9	28.42
TT25-1150/300	615 812 082 0	45	1562.1	61.5	807.8	31.8
TT25-1600/600	615 812 261 0	45	2410.6	94.9	1232	48.5
TT50-1700/600	615 812 262 0	45	2626.8	103.4	1342.6	52.9
TT50-2100/900	615 812 263 0	45	3475.4	136.8	1766.9	69.6
TT100-1700/600	615 812 264 0	45	2657.1	104.6	1357.6	53.4
TT100-2100/900	615 812 265 0	45	3505.6	138.0	1781.8	70.2



Tool clamp guide for TT arms

Ordering Process:

SELECT YOUR TOOL	SELECT THE ARM ACCORDING TO: - THE TORQUE APPLICATION - THE REACH NEEDED	ADD THE TOOL CLAMP	ADD THE BALANCER KIT + BALANCER	ADD OPTIONS IF NEEDED	
STEP 1 TOOL MODEL	STEP 2 TT MODEL	STEP 3 TOOL CLAMP REFERENCE PICTURE	STEP 4 BALANCER KIT AND BALANCER REFERENCES	STEP 5 OPTIONS	
SB, SC2, SD, SLC, ECD5 ECS(A-F), ERS(A-F) ERDL 1.5-12, SLBN	TT10 : 6158122600	6158122150	A	6158121410 Balancer DU fixation 4DU: 50532 / 4DU: 50532 5DU: 50542 / 4DU: 50532 5DU: 50542 / 5DU: 50542 5DU: 50542 / 5DU: 50542 5DU: 50542	Gravity center adjustment: 6158122030 Rigid fixation : 6158122110
SD 070/072, SCLP	TT10 : 6158122600	6158122180		6158121410 Balancer DU fixation 5DU: 50542	Gravity center adjustment: 6158122030 Rigid fixation : 6158122110
SH 70/150	TT25 1160/300 : 6158120820 TT25 1600/600 : 6158122610	6158122200		6158121450 Balancer D fixation 10D: 50052	Gravity center adjustment: 6158121490 Rigid fixation : 6158121570
ECS (A-F), ERS (A-F) ECD30, SLBN 120 SD 130/140/160/220	TT25 1160/300 : 6158120820 TT25 1600/600 : 6158122610	6158121610	A	6158121450 Balancer D fixation 10D: 50052	Gravity center adjustment: 6158121490 Rigid fixation : 6158121570
EID 25	TT25 1160/300 : 6158120820 TT25 1600/600 : 6158122610	6158121950		6158121450 Balancer D fixation 10D: 50052	Gravity center adjustment: 6158121490 Rigid fixation : 6158121570
ECD20, ERDL	TT25 1160/300 : 6158120820 TT25 1600/600 : 6158122610	6158121960		6158121450 Balancer D fixation 10D: 50052	Gravity center adjustment: 6158121490 Rigid fixation : 6158121570*
EFDE43-8/15	TT25 1160/300 : 6158120820 TT25 1600/600 : 6158122610	6158121980		6158121450 Balancer D fixation 15D: 50062	Gravity center adjustment: 6158121490 Rigid fixation : 6158121570
MC35-20, MC38-10 EME35-20J, EME38-10J	TT25 1160/300 : 6158120820 TT25 1600/600 : 6158122610	6158121970		6158121450 Balancer D fixation 15D: 50062	Gravity center adjustment: 6158121490 Rigid fixation : 6158121570
SH 200/280	TT25 1160/300 : 6158120820 TT25 1600/600 : 6158122610	6158121990		6158121450 Balancer D fixation 10D: 50052	Gravity center adjustment: 6158121490 Rigid fixation : 6158121570
EAD20, EAB@ 15/26 ERAL 2-30/40, SDP 209/300 SH 150/280	TT25 1160/300 : 6158120820 TT25 1600/600 : 6158122610	6158122000		6158121450 Balancer D fixation 10D: 50052	Gravity center adjustment: 6158121490 Rigid fixation : 6158121570
ECA 15/20/30 ERAL 1.5-15/25/35	TT25 1160/300 : 6158120820 TT25 1600/600 : 6158122610	6158122010		6158121450 Balancer D fixation 10D: 50052	Gravity center adjustment: 6158121490 Rigid fixation : 6158121570
ERSA 12	TT25 1160/300 : 6158120820 TT25 1600/600 : 6158122610	6158122020		6158121450 Balancer D fixation 10D: 50052	Gravity center adjustment: 6158121490 Rigid fixation : 6158121570
ERDL 1,5/2, ECD 30	TT50 1700/600 : 6158122620 TT50 2100/900 : 6158122630	6158125750		6158121450 Balancer D fixation 22D: 50072	Gravity center adjustment: 6158125320 Rigid fixation : 6158125350
EAB(C) 26/32/45, EAD 20/32	TT50 1700/600 : 6158122620 TT50 2100/900 : 6158122630	6158129030 + 6158128880		6158121450 Balancer D fixation 22D: 50072 15D: 50062	Gravity center adjustment: 6158125320 Rigid fixation : 6158125350
ECA 20/30/40/60	TT50 1700/600 : 6158122620 TT50 2100/900 : 6158122630	6158129030 + 6158128930		6158121450 Balancer D fixation 22D: 50072	Gravity center adjustment: 6158125320 Rigid fixation : 6158125350
SH 420/500	TT50 1700/600 : 6158122620 TT50 2100/900 : 6158122630*	6158129030 + 6158128940		6158121450 Balancer D fixation 22D: 50072	Gravity center adjustment: 6158125320 Rigid fixation : 6158125350
EFDE(S) 43-30/45 EME 51-70, MC 51-10/20	TT50 1700/600 : 6158122620 TT50 2100/900 : 6158122630	6158125420		6158125220 Balancer DF fixation 14DF: 6158050140 for TT100 2100	Gravity center adjustment: 6158125320 Rigid fixation : 6158125350
EID 25/32/44	TT50 1700/600 : 6158122620 TT50 2100/900 : 6158122630	6158125740 + 6158129010		6158121450 Balancer D fixation 22D: 50072	Gravity center adjustment: 6158125390 Rigid fixation : 6158125350
ERDL 1,5-30 ERDL 2-40/50	TT50 1700/600 : 6158122620 TT50 2100/900 : 6158122630	6158125740 + 6158129020		6158121450 Balancer D fixation 22D: 50072	Gravity center adjustment: 6158125390 Rigid fixation : 6158125350
ERAL 2-60/80	TT50 1700/600 : 6158122620 TT50 2100/900 : 6158122630	6158129030 + 6158128890		6158121450 Balancer D fixation 22D: 50072	Gravity center adjustment: 6158125320 Rigid fixation : 6158125350
SH 700	TT100 1700/600 : 6158122640 TT100 2100/900 : 6158122650	6158129040 + 6158128890		6158121450 Balancer D fixation 22D: 50072	Gravity center adjustment: 6158125390 Rigid fixation : 6158125350
	TT50 1700/600 : 6158122620 TT50 2100/900 : 6158122630	6158129030 + 6158128900		6158121450 Balancer D fixation 22D: 50072	Gravity center adjustment: 6158125320 Rigid fixation : 6158125350
EAB(C,A) 50 EAD 50	TT50 1700/600 : 6158122620 TT50 2100/900 : 6158122630	6158129030 + 6158128910		6158121450 Balancer D fixation 22D: 50072	Gravity center adjustment: 6158125320 Rigid fixation : 6158125350
	TT100 1700/600 : 6158122640 TT100 2100/900 : 6158122650	6158129040 + 6158128910		6158121450 Balancer D fixation 22D: 50072	Gravity center adjustment: 6158125390 Rigid fixation : 6158125350
EAB(C) 60	TT50 1700/600 : 6158122620 TT50 2100/900 : 6158122630	6158129030 + 6158128920		6158121450 Balancer D fixation 22D: 50072	Gravity center adjustment: 6158125320 Rigid fixation : 6158125350
	TT100 1700/600 : 6158122640 TT100 2100/900 : 6158122650	6158129040 + 6158128920		6158121450 Balancer D fixation 22D: 50072 14DF: 6158050140 for TT100 2100	Gravity center adjustment: 6158125390 Rigid fixation : 6158125350
ERAL 4-90/110/120	TT100 1700/600 : 6158122640 TT100 2100/900 : 6158122650	6158129040 + 6158128960		6158121450 Balancer D fixation 6158125220 Balancer DF fixation for TT100 2100 22D: 50072 14DF: 6158050140 for TT100 2100	Gravity center adjustment: 6158125390 Rigid fixation : 6158125350
SH 850	TT100 1700/600 : 6158122640 TT100 2100/900 : 6158122650	6158129040 + 6158128970		6158121450 Balancer D fixation 6158125220 Balancer DF fixation for TT100 2100 22D: 50072 14DF: 6158050140 for TT100 2100	Gravity center adjustment: 6158125390 Rigid fixation : 6158125350
ECA 70/90/115/125/150	TT100 1700/600 : 6158122640 TT100 2100/900 : 6158122650	6158129040 + 6158128980		6158121450 Balancer D fixation 6158125220 Balancer DF fixation for TT100 2100 22D: 50072 14DF: 6158050140 for TT100 2100	Gravity center adjustment: 6158125390 Rigid fixation : 6158125350
ECA 70/90/115	TT100 1700/600 : 6158122640 TT100 2100/900 : 6158122650	6158129040 + 6158128980		6158121450 Balancer D fixation 6158125220 Balancer DF fixation for TT100 2100 22D: 50072 14DF: 6158050140 for TT100 2100	Gravity center adjustment: 6158125390 Rigid fixation : 6158125350
ECA 125/150	TT100 1700/600 : 6158122640 TT100 2100/900 : 6158122650	6158129040 + 6158128980		6158125220 Balancer DF fixation 14DF: 6158050140 for TT100 2100	Gravity center adjustment: 6158125390 Rigid fixation : 6158125350
EAD 70/80/105	TT100 1700/600 : 6158122640 TT100 2100/900 : 6158122650	6158129040 + 6158128950		6158125220 Balancer DF fixation 14DF: 6158050140 for TT100 2100	Gravity center adjustment: 6158125390 Rigid fixation : 6158125350*
EID 65/75	TT100 1700/600 : 6158122640 TT100 2100/900 : 6158122650	6158125770 + 6158129000		6158125220 Balancer DF fixation 14DF: 6158050140 for TT100 1700 / 17DF: 6158050150 for TT100 2100	Gravity center adjustment: 6158125390 Rigid fixation : 6158125350
EFDE(S) 51-70	TT100 1700/600 : 6158122640 TT100 2100/900 : 6158122650	6158125760		6158125220 Balancer DF fixation 17DF: 6158050150 for TT100 1700 / 21DF: 6158050160 for TT100 2100	Gravity center adjustment: 6158125390 Rigid fixation : 6158125350*
EFDE 43-30/45 , MC 51-10/20 EME 51-10J/20J, EME 60-10	TT100 1700/600 : 6158122640 TT100 2100/900 : 6158122650	6158125760		6158125220 Balancer DF fixation 14DF: 6158050140 for TT100 1700 / 17DF: 6158050150 for TT100 2100	Gravity center adjustment: 6158125390 Rigid fixation : 6158125350



Balancing arms D57, D58, D59



D57/D57X/D58 How To Order

1. Basic Stand
2. Tool Holder
3. Optional Accessories

D59 How To Order

1. Basic Stand
2. Tool Holder
3. Rail (supplied per meter, e.g. for 3m order (3) of PN. 409213)
4. Rail End Stops (2 required per complete rail)
5. Optional Accessories

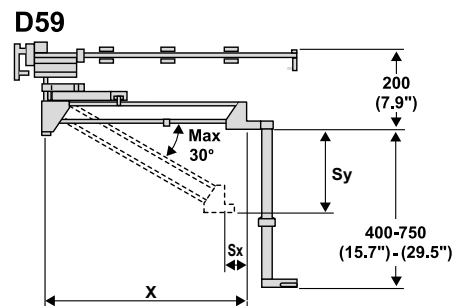
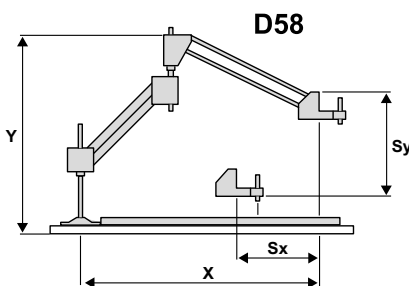
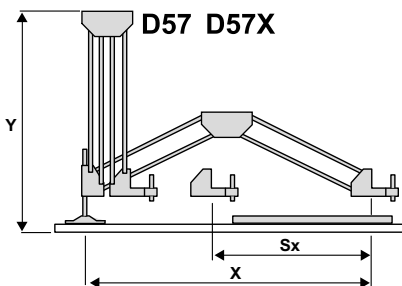
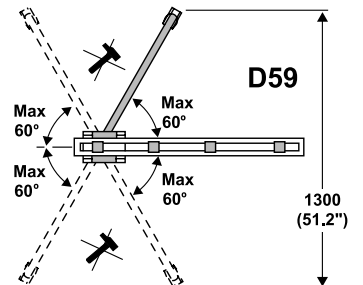

D57 / 58 / 59 BALANCING ARMS

PIC REF.	MODEL	PART NUMBER	MAXIMUM TORQUE		OVERALL HORIZONTAL (X)		OVERALL VERTICAL (Y)		STROKE HORIZONTAL (Sx)		STROKE VERTICAL (Sy)		TOOL WEIGHT CAPACITY		ACCESSORIES INCLUDED
			N.m	ft.lb	mm	in.	mm	in.	mm	in.	mm	in.	kg	lb	
A	D57	408903	20	14.75	700	25.55	550	21.6	510	20.7	95	3.74	2	4.4	BENCH MOUNT
A	D57X	408913	20	14.75	850	33.46	550	21.6	610	24.0	95	3.74	2	4.4	BENCH MOUNT
B	D58	408923	20	14.75	710	27.95	600	23.6	600	23.6	180	7.08	2	4.4	BENCH MOUNT
C	D59	408933	20	14.75	650	25.60	200	7.87	70	2.75	250	9.84	2	4.4	RAIL CARRIAGE

Tool clamps

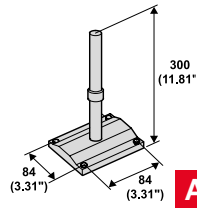

A

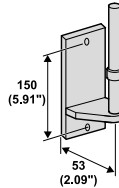

B

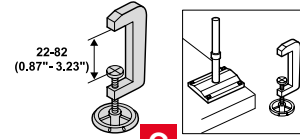

C

ACCESSORIES

ITEM	PART NO.	DESCRIPTION	D57 / D57X	D58	D59
A	408953	Bench Mount (Included with the stand)	✓	✓	
B	408963	Wall Mount Bracket	✓	✓	
C	408973	Table Stand Clamp	✓	✓	
	408993	Heavy Duty Spring 1 - 2,5 kg	✓		
D	409253	Rail Carriage (Included with the stand)			✓
E	409213	Rail Per Meter			✓
F	409223	Rail End Stops			✓
G	409203	Telescopic Height Adjustments			✓
H	409233	Top Arrester / Vertical Lock			✓
H	409243	Side Arrester / Horizontal Lock			✓

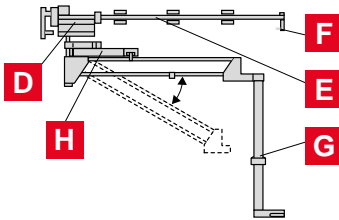

must also order top arrester when using side arrester

D57/58/59 TOOL CLAMPS	Ø28.5-41MM	Ø40-50MM	VERTICAL 2 AXIS ROTATION	HORIZONTAL SINGLE AXIS ROTATION	HORIZONTAL 2 AXIS ROTATION	ADAPTOR SLEEVE BLANK (supplied as standard with tool holders) to be machined to suit the tool
PART NO.	615 396 6140	615 396 6290	409083 Ø36mm (1.42) 409093 Ø46mm (1.8) 409103 Ø56mm (2.2)	409113 Ø36mm (1.42) 409123 Ø46mm (1.8) 409133 Ø56mm (2.2)	409173 Ø36mm (1.42) 409183 Ø46mm (1.8)	409273 Ø46mm (1.8) (OUTSIDE) Ø30mm (1.18) (INSIDE) 409023 Ø56mm (2.2) (OUTSIDE) Ø40mm (1.57) (INSIDE)

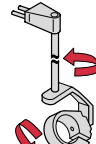
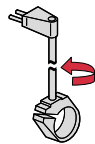
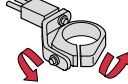

Pneumatic Screwdrivers

SB / SBP	✓		409083	409113	409173	
SC2 / SCP / SCPT	✓		409083	409113	409173	
SD / SDP	✓		409093	409123	409183	Ring adaptor PN 409273 for SD
SH70 / SH150	✓		409093	409123	409183	

Electric Screwdrivers

SLBN	✓		409093	409123	409183	Ring adaptor PN 409273
SLC (nose mount)	✓		409083	409113	409173	
SLC (top mount)		✓	409093	409123	409183	
ECS	✓		409083	409113	409173	
ECD5	✓		409083	409113	409173	
ERD5	✓		409083	409113	409173	

Drills

DR 300	✓		409083	409113	409173	
DR 350				409113	409173	
DR 750				409123	409183	Ring adaptor PN 409273

Balancers D & HU Series

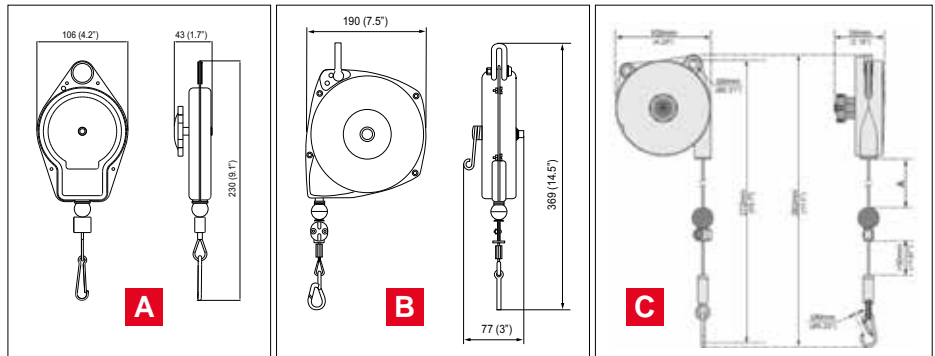

- Steel housing
- Nylon (pic A) Steel (pic B,C) cable
- Additional support chain included
- 10S / 15S / 22S with drum lock feature: operates only on spring failure

BALANCERS - 1DU - 22S

PIC REF	MODEL	PART NUMBER	LOAD RANGE				CABLE TRAVEL		WEIGHT	
			MIN. CAPACITY		MAX. CAPACITY		m	ft	kg	lb
A	1DU	52542	0	0	0.5	1.1	1.5	4.9	0.6	1.3
	2DU	50522	0.5	1.1	1.0	2.2	1.5	4.9	0.6	1.3
	2DUS	54532	0.5	1.1	1.0	2.2	3.0	9.8	0.6	1.3
	3DU	52862	1.0	2.2	1.5	3.3	1.5	4.9	0.6	1.3
	4DU	50532	1.0	2.2	2.0	4.4	1.5	4.9	0.6	1.3
B	5DU	50542	1.4	3.1	2.4	5.3	1.5	4.9	0.6	1.3
	10D	50052	2.5	5.5	5.0	11.0	2.4	7.8	2.7	6.0
	15D	50062	5.0	11.0	7.0	15.4	2.4	7.8	3.2	7.1
	22D	50072	6.0	13.2	10.0	22.0	2.4	7.8	3.2	7.1
	10S*	50572	2.0	4.4	5.0	11.0	2.4	7.8	2.7	6.0
C	15S*	50582	5.0	11.0	7.0	15.4	2.4	7.8	3.2	7.1
	22S*	50592	6.0	13.2	10.0	22.0	2.4	7.8	3.2	7.1
	2DSB	615 812 791 0	0.4	0.88	1	2.2	1.6	5.25	0.57	1.25
	2DSBX	615 812 794 0	0.4	0.88	1	2.2	3	9.84	0.57	1.25
	4DSB	615 812 792 0	1	2.2	2	4.4	1.6	5.25	0.6	1.32

* Balancers with drum lock features

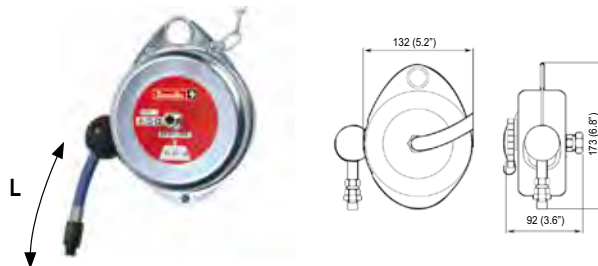

- Steel housing
- Additional support chain included
- Polyurethane hose
- 1/4" thread

HOSE BALANCERS - 1HU - 4HU

MODEL	PART NUMBER	LOAD RANGE				HOSE TRAVEL		HOSE ID		WEIGHT	
		MIN. CAPACITY		MAX. CAPACITY		m	ft	mm	in.	kg	lb
1HU	52552	0	0	0.5	1.1	1.5	4.9	6.5	1/4	1.2	2.6
3HU	50552	0.5	1.1	1.4	3.1	1.0	3.3	6.5	1/4	1.2	2.6
4HU	50562	0.7	1.5	2.0	4.4	1.0	3.3	6.5	1/4	3.3	7.3
4HU-X*	205 148 128 4	0.7	1.5	2.0	4.4	1.0	3.3	6.5	1/4	3.3	7.3

Flow rate: 7.1 l/s (15cfm) - *L= 0.5

Balancers - ZG, DF & DFL Series



- Reaction free: holds the load weightless throughout the entire cable length
- Rigid and impact-resistant plastic and aluminum housing
- 360° swiveling safety hook for isolated suspension
- Screw-type safety hook for load suspension
- Standard safety chain
- Spring fracture safeguard, integrated drum lock

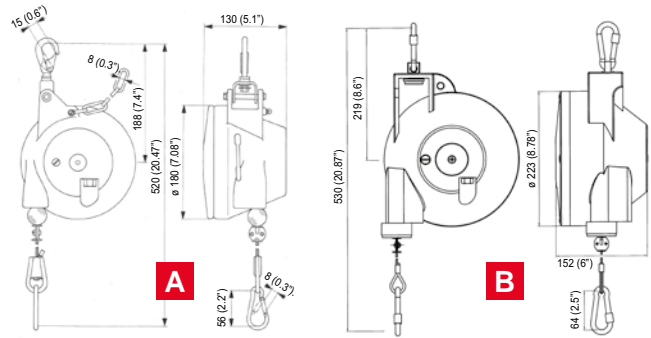

BALANCERS - 5DF - 55 DF

PIC REF	MODEL	PART NUMBER	LOAD RANGE				CABLE TRAVEL		WEIGHT	
			MIN. CAPACITY		MAX. CAPACITY		m	ft	kg	lb
			kg	lb	kg	lb			kg	lb
A	12ZG	615 813 077 0	0,4	0.88	1,2	2.65	1,6	5.25	1.3	2.87
	26ZG	615 813 078 0	1,2	2.65	2,6	5.73	1,6	5.25	1.4	3.09
	38ZG	615 813 079 0	2,6	5.73	3,8	8.38	1,6	5.25	1.5	3.31
	52ZG	615 813 080 0	3,8	8.38	5,2	11.46	1,6	5.25	1.5	3.31
	65ZG	615 813 081 0	5,2	11.46	6,5	14.33	1,6	5.25	1.5	3.31
	5DF	615 805 011 0	3.0	6.6	5.0	11.0	2.0	6.6	2.9	6.4
	7DF	615 805 012 0	4.5	9.9	7.0	15.4	2.0	6.6	3.1	6.8
	10DF	615 805 013 0	6.0	13.2	10.0	22.0	2.0	6.6	3.2	7.1
	14DF	615 805 014 0	9.0	19.8	14.0	30.9	2.0	6.6	3.4	7.5
	17DF	615 805 015 0	13.0	28.7	17.0	37.5	2.0	6.6	3.6	7.9
B	21DF	615 805 016 0	16.0	35.3	21.0	46.3	2.0	6.6	3.8	8.4
	25DF	615 805 017 0	15.0	33.1	25.0	55.1	2.0	6.6	7.8	17.2
	35DF	615 805 018 0	25.0	55.1	35.0	77.2	2.0	6.6	8.9	16.6
	45DF	615 805 019 0	35.0	77.2	45.0	99.2	2.0	6.6	9.5	20.9
	55DF	615 805 020 0	45.0	99.2	55.0	121.2	2.0	6.6	9.7	21.4

A Plastic housing B Aluminum housing



- Reaction free: holds the load weightless throughout the entire cable length
- Rigid and impact-resistant aluminum housing
- 360° swiveling safety hook
- Cable extension limit stop for overload protection
- Screw-type safety hook for load suspension
- Standard safety chain
- Standard spring fracture safeguard integrated drum lock
- Ferrule for securing cable end
- Freewheel device for protection against handling errors

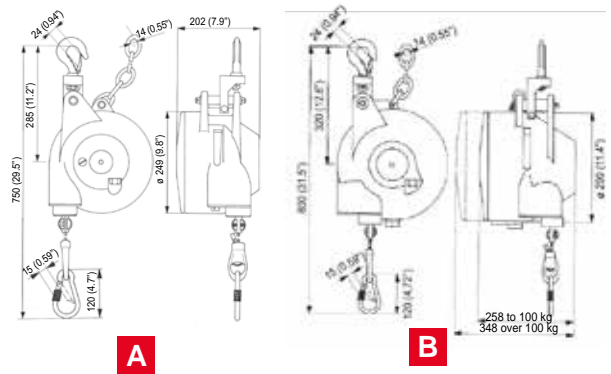

BALANCERS - 20DFL - 200DFL

PIC REF	MODEL	PART NUMBER	LOAD RANGE				CABLE TRAVEL		WEIGHT	
			MIN. CAPACITY		MAX. CAPACITY		m	ft	kg	lb
			kg	lb	kg	lb			kg	lb
A	20DFL	615 805 021 0	12	26.5	20	44.1	2.0	6.6	14.8	32.6
	30DFL	615 805 022 0	20	44.1	30	66.1	2.0	6.6	15.2	33.5
	45DFL	615 805 023 0	30	66.1	45	99.2	2.0	6.6	16.9	37.2
	60DFL	615 805 024 0	45	99.2	60	132.3	2.0	6.6	17.3	38.1
	75DFL	615 805 025 0	60	132.3	75	165.3	2.0	6.6	18.7	41.2
	90DFL	615 805 026 0	75	165.3	90	198.4	2.0	6.6	19.7	43.4
	100DFL	615 805 027 0	90	198.4	100	220.4	2.0	6.6	20.9	46.1
	115DFL	615 805 028 0	100	220.4	115	253.5	3.0	9.8	41.8	92.1
	130DFL	615 805 029 0	115	253.5	130	286.6	3.0	9.8	43.2	95.2
	140DFL	615 805 030 0	130	286.6	140	308.6	3.0	9.8	44.6	98.3
B	150DFL	615 805 031 0	140	308.6	150	330.7	3.0	9.8	46.0	101.4
	170DFL	615 805 032 0	150	330.7	170	374.8	3.0	9.8	46.4	102.3
	180DFL	615 805 033 0	170	374.8	180	396.8	3.0	9.8	46.7	102.9
	190DFL	615 805 034 0	180	396.8	190	418.9	3.0	9.8	47.0	103.6
	200DFL	615 805 035 0	190	418.9	200	440.9	3.0	9.8	47.3	104.2

ASD - Automatic screw dispenser

TO BE USED FOR THE ASSEMBLY OF:

- Electronics: TV, mobile phones, computers
- Medical products
- Small appliances

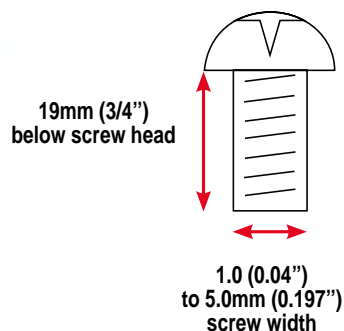

Boost your productivity and efficiency

- **Widest range of screw sizes:** between 1.0 (0.04") and 5.0mm (0.197") thread diameters (about 11 different screw sizes) including screws with captive washers and up to 19mm (3/4") screw length (under head)
- **Complete:** supplied with universal feeding rail to avoid buying additional and expensive spare rails
- **Fully adjustable:** vibration time, vibration intensity, and drum rotation time adjustments allow the user to optimize the screw feed rate
- **Quiet operation & easy to service**
- Includes: rail adjustment kit, AC adapter and ground wire

PART NUMBER	POWER PLUG	SCREW RANGE		RAIL ADJUSTMENT KIT	DIMENSIONS						POWER
		SIZE	LENGTH		L		H		W		
			mm	in.	mm	in.	mm	in.	mm	in.	

Automatic Screw Dispenser - ASD

615 810 472 0	UK	M1.0 to M5.0	Up to 19	Up to 3/4"	included	126	5	147	5.8	182	7.2	AC 100 ~ 240V
615 810 473 0	EUR	M1.0 to M5.0	(under head)	(under head)								
615 810 474 0	US	0.04" to 0.197"										



Drilling and Riveting - Selection Guide

TOOL TYPE	PAGE
<p>PNEUMATIC ADVANCED DRILLING UNIT</p> 	<p>212-213</p>
<p>ELECTRIC ADVANCED DRILLING UNITS</p> 	<p>214-216</p>
<p>LIGHT AUTOMATION SOLUTIONS</p> 	<p>217</p>
<p>XPB - Multifunction platform for manual operations</p> 	<p>218-219</p>
<p>MULTI DRILLS</p> 	<p>220-225</p>
<p>DRILLS - Pneumatic manual drilling</p> 	<p>226-234</p>
<p>SPECIALITY TOOLS - Taper - Rivet Shaver & Rack - Rack Feed Drills</p> 	<p>235-239</p>
<p>RIVETING COMPRESSION TOOLS</p> 	<p>240-243</p>
<p>RIVETING HAMMERS</p> 	<p>245-247</p>

Solutions for aerospace Smart Factory

Aerospace is a fantastic and extremely demanding industry, often synonymous with highly skilled personal and cutting-edge technologies. But with a production characterized by relatively small volumes, long cycle times, large components and high variability in the production processes, this industry offers specific challenges when it comes to the dissemination of smart tools and solutions.

As volumes continue to grow with people travelling more & more, all major OEMs need to increase the overall process efficiency, limit quality costs and cycle times, and exclude human factors as a source of error. With intelligent software and digital networking, assembly tools can now make a key contribution. They offer far greater flexibility and can be fully linked both to each other and to manufacturers' production and quality systems.



Intelligent assembly solutions

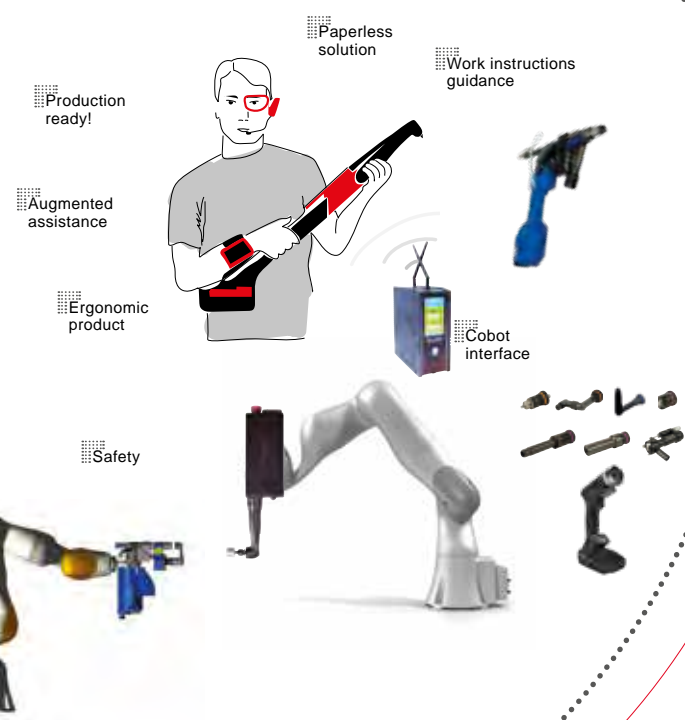

DESOUTTER 4.0

Product range

As market leaders for advanced drilling solutions in aerospace, our experts are working daily with the most demanding customers to reach the highest level of quality, productivity and safety necessary in the aerospace market.

The SETITEC semi-automated tools have been drilling thousands of holes daily, in any possible configuration, facing the most challenging environments and delivering the highest level of performance.

Building on this expertise, and faithful to its philosophy of innovation, modularity, and expertise, SETITEC has used combined the potential of electric technology and drilling expertise to develop the electric range éVo, improving even further the drilling operations.

Still driving the innovation, SETITEC latest range of light multi-function end-effectors will accelerate the transformation of robotic solutions in the aerospace assembly processes.

Advanced Pneumatic Drilling

Software
Advanced drilling strategies
Data driven services



Advanced Electric Drilling

Light end effector solutions

Full Range Dedicated to Aerospace Applications



		PNEUMATIC RANGE	éVo RANGE			
			SEMI-AUTOMATED ELECTRIC RANGE		ROBOTIC RANGE	
			Light éVo	Modular éVo	Drilling	Other applications (tightening...)
	Drilling strategies	Pneumatic strategies	Electric Advanced strategies			
	Software		Software plateforme			
	Control box	Control box / additional robotic box				
	Cable	Multi-energy cable for éVo range				
	Heads	Shared components between all ranges				
	Support & Service	SETITEC & Desoutter service & project team				

SETITEC Automatic Drilling Unit

1 Step operation - Drilling - Reaming - Countersinking



Part of Desoutter product portfolio, **SETITEC line** offers best-in class performance, quality and reliability for the most demanding drilling applications worldwide.

SETITEC solutions have already been adopted by all major Aircraft manufacturers worldwide

This concept is dedicated to highly demanding drilling, reaming, countersinking applications, where quality, precision and repeatability are critical.

Its innovative design make one step drilling, reaming, countersinking possible, and will help driving down your cycle time.

Its design based on modularity concept and the wide variety of clamping options will answer most of your applications.

In addition to the current ST1200 and ST220 pneumatic range, the Electric Drilling Unit range éVo is raising the drilling performance to a new standard.

1 STEP OPERATION	➔	PRODUCTIVITY
DRILLING REAMING	➔	QUALITY
COUNTERSINKING	➔	SAFETY

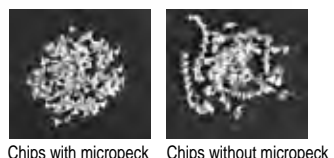
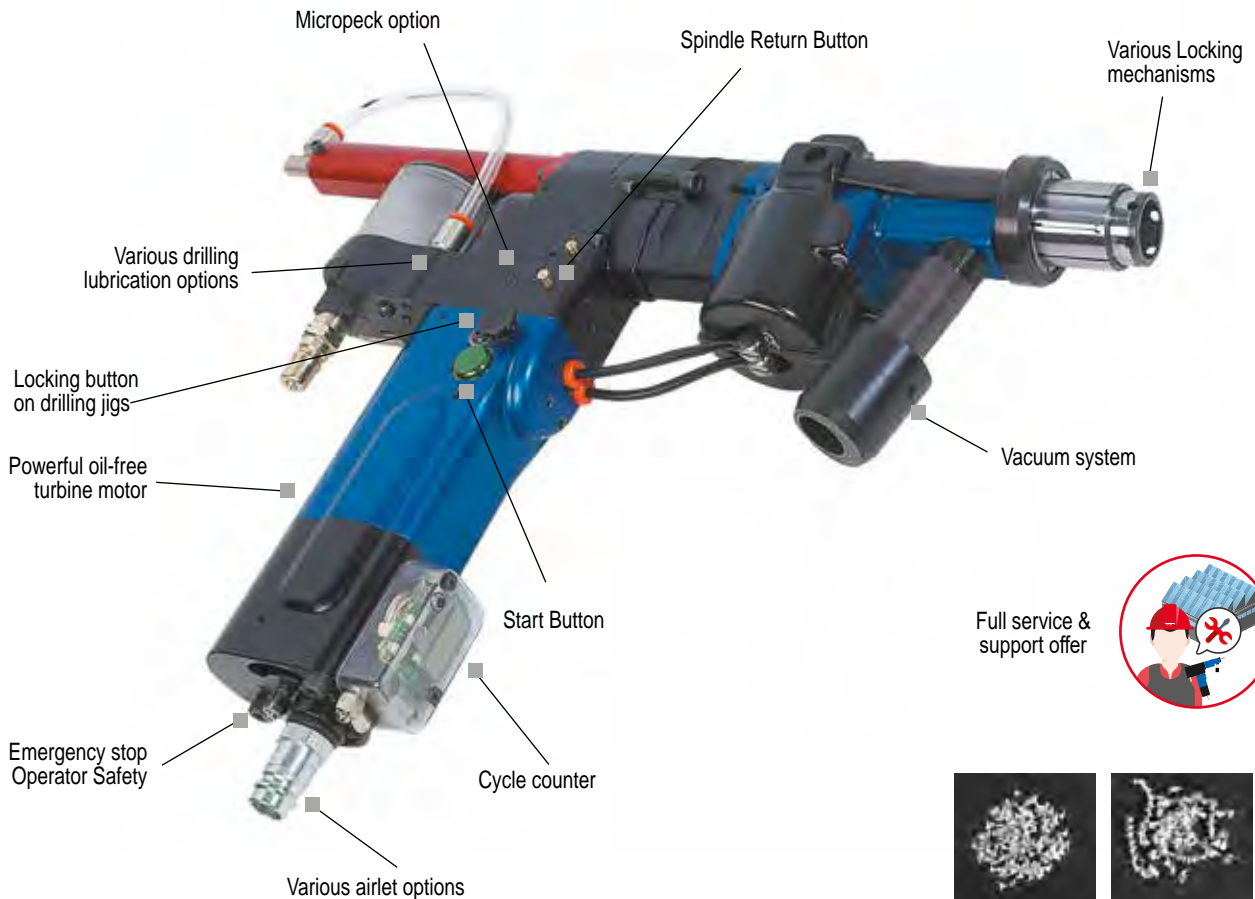

SETITEC Automatic Drilling Unit

Modular Concept

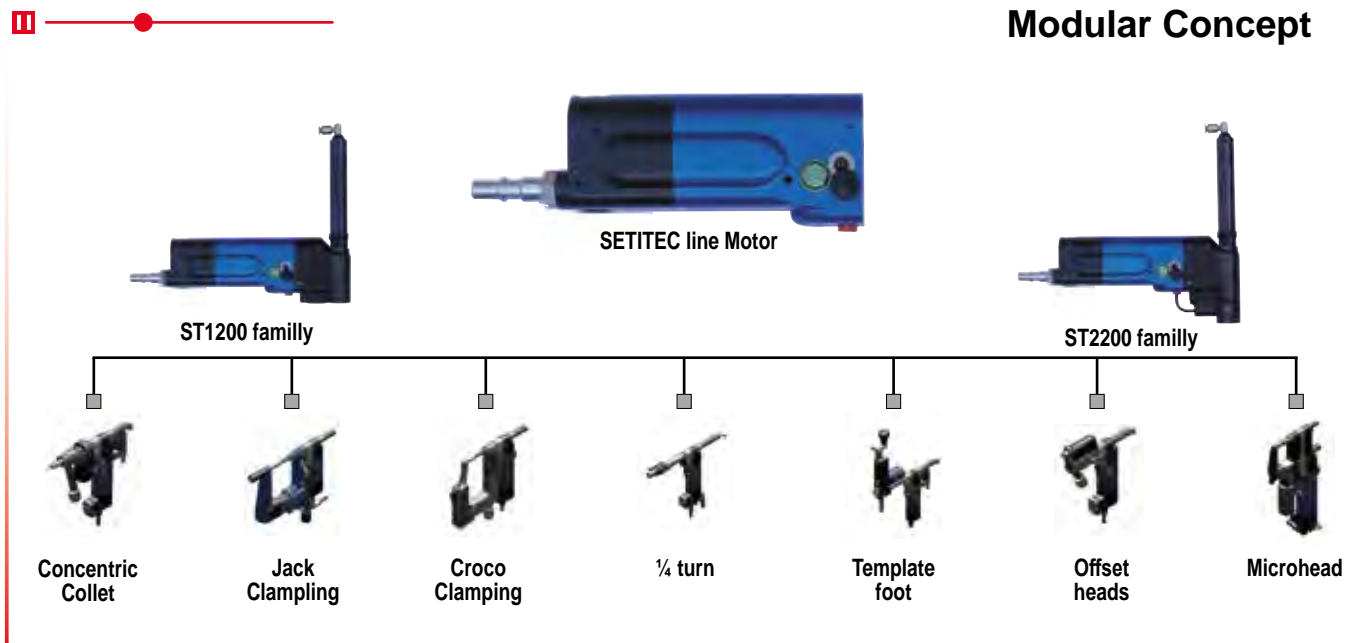

Technical information

	ST1200		ST2200	
Power	2.8 HP, with torque limiter at lower speed			
Weight	1.5 kg (3.3lb)		4.2 kg (9.2lb)	
Stroke	Unlimited		Unlimited	
Feed rate	0,010	mm/rev	0,032	mm/rev
	0,021	mm/rev	0,047	mm/rev
	0,038	mm/rev	0,059	mm/rev
	0,058	mm/rev	0,095	mm/rev
	0,077	mm/rev	0,120	mm/rev
	0,095	mm/rev	0,146	mm/rev
	0,115	mm/rev	0,182	mm/rev
	0,154	mm/rev	0,200	mm/rev
	0,35	mm/rev	0,315	mm/rev

Any specific requirement can be handled by SETITEC Line design team. Contact your Desoutter representative for assistance.



	ST1200		ST2200	
	In Line	Right Angle	In Line	Right Angle
11835	2919	2195		
8179	2560	1925		
6543	1717	1291		
6543	1216	915		
6000	2017	1517		
5550	4674	1770	1331	
3514	2959	1187	892	
2811	2367	841	632	
2428	2045	1614	1214	
2008	1691	1416	1065	
1943	1636	949	714	
1554	1309	672	506	
1388	1168	730	549	
1110	935	640	481	
878	740	429	323	
793	668	304	229	
703	592	584	439	
562	473	512	385	
502	423	343	258	
402	338	243	183	
287	242	174	131	

HOLE DIAMETER	ALUMINIUM COMPOSITE	TITANIUM HARD METAL	ALUMINIUM COMPOSITE	TITANIUM
	Straight hole		Countersink hole	
<4,8mm - 3/16"	ST 1200	ST 1200	ST 1200	ST 1200
<6,35mm - 1/4"				
<7,9mm - 5/16"				
<9,5mm - 3/8"				
<11,1mm - 7/16"				
<12,7mm - 1/2"				
<14,3mm - 9/16"				
<15,9mm - 5/8"	ST 2200	ST 2200	ST 2200	
<19,5mm - 3/4"				
<22,2mm - 7/8"				
<25,4mm - 1"				
Over 25,4mm - 1"				

	CONCENTRIC COLLET	BAYONET 1/4 TURN	CROCO CLAMP	JACK CLAMP	TEMPLATE FOOT	CROWFOOT
Thick jig	ST1200 ST2200					
Thick jig with rail or screws		ST1200 ST2200				ST1200 ST2200
Thin jig			ST1200	ST1200	ST1200	
No jig (pre-hole)			ST1200	ST1200	ST1200	

SETITEC éVo range

SOFTWARE SUITE

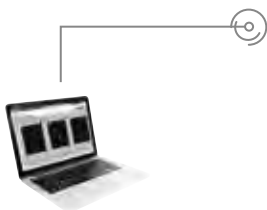

- Create and optimize your drilling cycle
- Setup your tool
- Setup your maintenance strategy
- Live visualization of drilling operation

UNIQUE RANGE OF TOOLS

- Modular éVo
- Light éVo
- Robotics

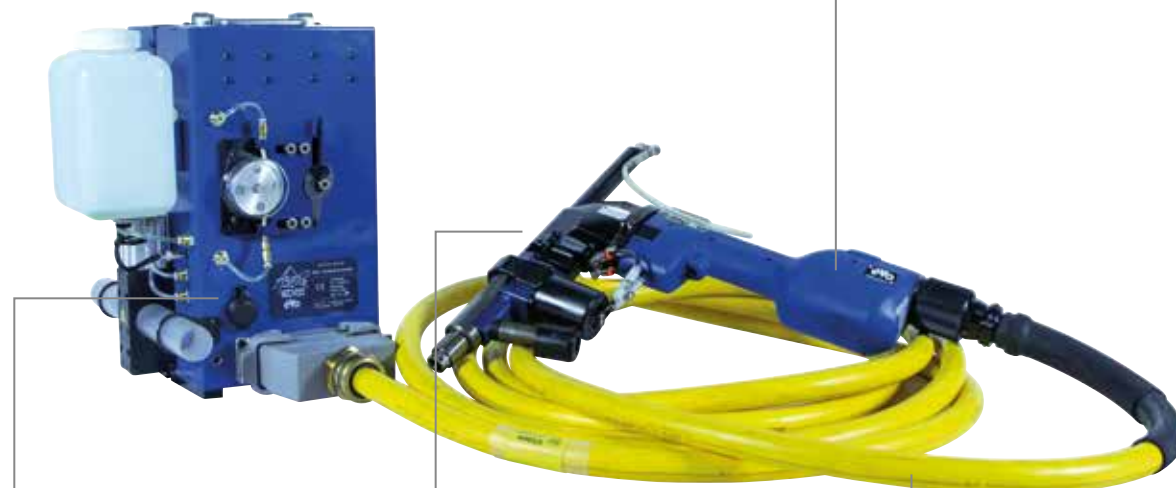

CONTROL BOX

- Open architecture
- Drilling cycle storage
- Drilling curves storage
- Ready for network integration
- Drilling management of robotics applications

HEADS & EQUIPMENTS

- Wide range of heads & equipments covering all drilling applications
- Full modularity between pneumatic & electric range

MULTI ENERGY CABLE

- Robust and flexible cable for:
 - Lubrication
 - Power
 - Air
 - Data

BOOST YOUR FLEXIBILITY

Full Modularity

- One tool to cover various applications
- Wide range of heads managed with Quick change RFID system
- Wide range of equipments, full commonality between pneumatic & electric range
- Easy rebalancing of drilling program between tools

Easy process qualification

- Easily test & optimize your cutting tools
- Easily create & optimize your drilling program

Ready for robotics applications

BOOST YOUR UP TIME

Optimized maintenance

- Cutting tool lifetime management
- Tool & head maintenance management
- Full compatibility between pneumatic/electric/robotic range
- Gain in Overall Equipment Effectiveness with easy reconfiguration of back up heads
- Full service offer

SMART ready

- Open architecture for integration in smart factory
- Ready for smart maintenance

BOOST YOUR PRODUCTIVITY

Cycle time reduction

- Optimized drilling parameters for each material
- Advanced drilling strategies
- Reduced cleaning time with smart lubrication management

Quality focus

- Advanced drilling strategies
- Poka Yoké system with RFID head identification
- Full traceability with drilling curve storage

Reduce Health & safe issues

- Reduce lubrication on shopfloor
- Low sound levels

SETITEC éVo range

Tool range

QUICK CHANGE HEAD SYSTEM WITH RFID IDENTIFICATION

Easily change your head to adapt to the application
Unlimited number of head per motor

FULL RANGE OF HEADS & EQUIPMENTS

Common with Pneumatic range of right angle and inline head sizes to cover all applications
Wide range of equipments to match your application

FULL SPEED RANGE COVERAGE

Patented winch system, to cover high speed & high torque applications

DISPLAY

Tool/head/drilling cycle information
Operator feedback

ROBUST AND POWERFUL MOTORS

2 independent motors for speed & feed

MONOBLOC VERSION, equipment dedicated to the tool

Modular éVo

Light éVo

Tool Range

The choice between Modular & Light éVo needs to be assessed for each application:

- Modular éVo**
 This tool can handle a wide range of drilling applications thanks to its modular design. Depending on the head chosen (S/L/L/XL) the M-éVo can cover all your drilling applications, from small to large holes & from CFRP to Titanium
- Light éVo**
 This tool is more suitable for repetitive drilling operations, with smaller holes and less demanding applications

		HOLE DIAMETER				
		mm	Ø 4.0 TO 6.4	Ø 6.4 TO 12.7	Ø 12.7 TO 25.4	> Ø 25.4
		in.	Ø 4/32" TO 1/4"	Ø 5/16" TO 1/2"	Ø 1/2" TO 1"	> Ø 1"
Material drilled	Alu / Alu	L-EDU capability	L-EDU capability	L-EDU capability	M-EDU capability	
	CFRP / CFRP	L-EDU capability	L-EDU capability	L-EDU capability	M-EDU capability	
	CFRP/ Al	L-EDU capability	L-EDU capability	L-EDU capability	M-EDU capability	
	Stack Titanium & hard metal	L-EDU capability	L-EDU capability	L-EDU capability	M-EDU capability	

L-EDU capability

M-EDU capability

SETITEC éVo range

Heads* & equipments selection

HEAD RECOMMENDATIONS

Hole diameter mm in.		STRAIGHT HOLE		COUNTERSINK HOLE		
		Alu/CFRP	Titanium/ Hard metal	Alu/CFRP	Titanium/ Hard metal	
<4,8	<3/16"	Small	Small	Small	Small	
<6,35	<1/4"					
<7,9	<5/16"			Small + GEAR	Small	
<9,5	<3/8"					
<11,1	<7/16"					
<12,7	<12,7"			Small + GEAR	Large	Large/GEAR
<14,3	<14,3"					
<15,9	<15,9"	Small + GEAR	Large/GEAR	Large/GEAR		
<19,05	<19,05"					
<22,2	<22,2"	Large/GEAR	X Large	X Large		
<25,4	<25,4"					
>25,4	>25,4"					

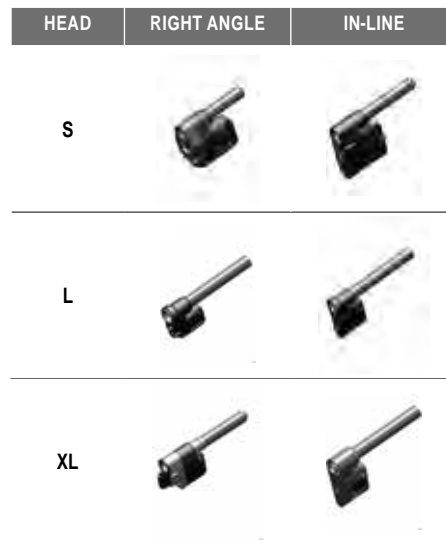

*Heads available in Right angle & inline versions.

EQUIPMENTS



Smart interface



- Setup your tool and heads with dedicated software
- Drilling cycle creation & optimization
Full control over all drilling parameters to optimize cycle time & quality
- Control your cutting tool lifetime and maintenance strategies with dedicated counters
- Life drilling curves visualization
- Advanced drilling strategies

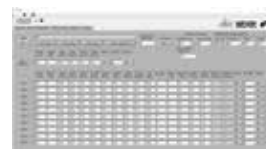

Integration in Smart factory

- Open architecture for integration in SMART Factory
- All drilling curves stored in control box
- Smart curves analysis software package

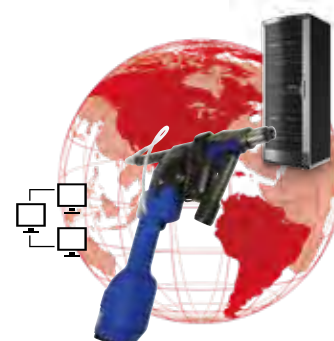

Light automation solutions

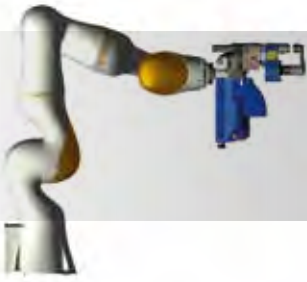

Building on its expertise on semi-automated drilling applications with electric éVo and driven by innovation, SETITEC is now developing a full range of innovative end-effectors for aerospace applications. Light, flexible, modular, this range will change the way you are integrating robotics in your factory.

Concept

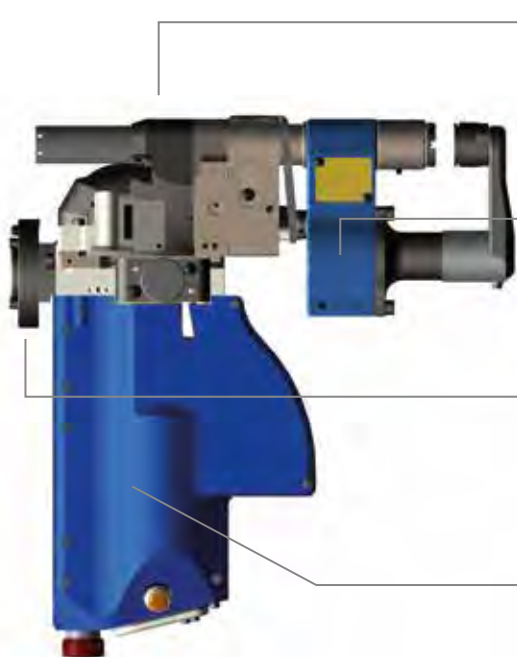

EXTREMELY LIGHT & COMPACT END-EFFECTOR

No need for heavy robotic arm
Extremely flexible in the shopfloor

FULL RANGE OF EQUIPMENTS

Fully customizable to your application
Example shown: J-Clamp with Self clamping

FIX CONNECTION TO ROBOT/COBOT

Customizable to any robot supplier

FULL MODULARITY

Same motor as Modular éVo range
Common equipment with portable éVo range
Same control box as the portable éVo range
Robotics box as "add-on"



SETITEC SOFTWARE PACKAGE

Drilling application managed by SETITEC software
Simple & efficient communication between end-effector & master system

Full Modularity with wide range of heads

All current SETITEC range of heads & equipments can be adapted to the robotic end-effector.

In addition to drilling, other applications are available:
Temporary fastener installation, riveting...

All solutions can be customized on the application.
Please contact your Desoutter & SETITEC representative for more information.



XPB - The future of aerospace manual operations

The aerospace world is transforming from the design phase to the production shopfloor. Robotic solutions, digitalized instructions, augmented reality are now used on a daily in all the aerospace plants worldwide.

Aerospace players deserve the most advanced technologies, and are looking at solutions to increase their flexibility, up-time & productivity.

As aerospace experts, Desoutter & SETITEC have designed a platform taking manual operation to an advanced level while satisfying today's and tomorrow's most demanding challenges.

Discover how to accelerate your transformation.



* Depending on model

XPB - Multifunction battery tool

Tool Range



XPB One*

- Drilling applications only
- Speeds adjustable via software

* Model available, please contact your Desoutter representative



+ Options

XPB Advanced

- Drilling applications only
- Display screen
- Up to 6 drilling cycles



+ Options

XPB Modular

- Multi applications
- Automatic cycle selection via RFID technology

Modularity



Drilling



Straight head



All drilling heads (page 207)



All Offset heads (page 208)



HCU heads

Temporary fasteners installation*



Heads for Lisi



Heads for Monogram

Frangible collars



* Other heads available, please contact your Desoutter representative

Software



Easy connectivity and user-friendly interface

Made for a fast tool setup creation and access to data

BOOST YOUR FLEXIBILITY

GO electric

- No need for heavy air network installation
- No more air hose - Full freedom of movement for the operator

Modular system

- One tool to cover various applications
- Wide range of heads managed with Quick change RFID system

BOOST YOUR UP TIME

Optimized maintenance

- Cutting tool lifetime management
- Tool & head maintenance management

SMART ready

- Optional Wifi module for integration in smart factory
- Open architecture

BOOST YOUR PRODUCTIVITY

Secure quality of your operation & error-proof your process

- Constant drilling speed
- Operator feedback
- Various smart drilling options









Reduce Health & safe issues

- No more tripping on air hose
- Low sound levels

Drill Selection Guide

How to select your tool:

- 1 Select material 2 Select hole size 3 Define speed

TOOL TYPE	FREE SPEED	TITANIUM	STAINLESS STEEL	HARD CAST IRON, MEDIUM HARD STEEL	SOFT CAST IRON, MILD STEEL 1	HARD PLASTICS	ALUMINIUM, BRASS, COPPER, BRONZE	COMPOSITE	WOOD, SOFT PLASTICS, CHIPBOARD	
	rpm		9-15m/min	10-20m/min	20-35m/min	30-40m/min	50-80m/min	50-100m/min	80-120m/min	
Drill ø mm										
STRAIGHT CASE										
DR300-T	20000							4.0 (5/32")	2.0 (5/64")	
	ø8-10 mm (5/16" - 3/8") cap.	5500					4.0 (5/32")	5.0 (3/16")	6.0 (1/4")	
		4500				3.0 (1/8")	6.0 (1/4")		8.0 (5/16")	
		3000				4.0 (5/32")	5.0 (3/16")	8.0 (5/16")		
		2000		3.0 (1/8")	4.0 (5/32")	6.0 (1/4")	8.0 (5/16")			
		1000	3.0 (1/8")	4.0 (5/32")	6.0 (1/4")	8.0 (5/16")				
		550	6.0 (1/4")	8.0 (5/16")						
30°, 45°, 90°, 360° COMPACT HEAD										
DR300-QR/-T5-S5	5500	-	-	-	-	3.0 (1/8")	5.0 (3/16")	5.0 (3/16")	5.0 (3/16")	
	4500	-	-	-	-	3.0 (1/8")	5.0 (3/16")	5.0 (3/16")	5.0 (3/16")	
	3000 3	-	-	-	3.0 (1/8") 2	5.0 (3/16")	5.0 (3/16")	5.0 (3/16")	-	
	2000	-	3.0 (1/8")	4.0 (5/32")	5.0 (3/16")	-	-	-	-	
	1000	-	4.0 (5/32")	5.0 (3/16")	-	-	-	-	-	
45°, 90°, 360° STANDARD HEAD										
DR300-QR/-T6-S6	5500	-	-	-	-	3.0 (1/8")	6.0 (1/4")	5.0 (3/16")	6.5 (1/4")	
	4500	-	-	-	-	3.0 (1/8")	6.0 (1/4")	5.0 (3/16")	6.5 (1/4")	
	3000	-	-	-	3.0 (1/8")	5.0 (3/16")	6.5 (1/4")	6.5 (1/4")	-	
	2000	-	3.0 (1/8")	4.0 (5/32")	6.5 (1/4")	6.5 (1/4")	-	6.5 (1/4")	-	
	1000	-	4.0 (5/32")	6.0 (1/4")	6.5 (1/4")	-	-	-	-	
	550	6.0 (1/4")	6.5 (1/4")	6.5 (1/4")	-	-	-	-	-	
DR450-T6/S6	18500	-	-	-	-	-	-	4.0 (5/32")	2.0 (5/64")	
	ø8-13 mm (5/16" - 1/2") cap.	5800	-	-	-	-	4.0 (5/32")	5.0 (3/16")	6.0 (1/4")	
		4300	-	-	-	3.0 (1/8")	6.0 (1/4")	10.0 (13/32")	12.0 (1/2")	
		2700	-	-	3.0 (1/8")	4.0 (5/32")	5.0 (3/16")	8.0 (5/16")	12.0 (1/2")	
		1800	-	3.0 (1/8")	4.0 (5/32")	6.0 (1/4")	8.0 (5/16")	10.0 (13/32")	-	
		1400	-	4.0 (5/32")	5.0 (3/16")	9.0 (11/32")	11.0 (7/16")	-	-	
90° HEAVY DUTY										
DR300-THD/SHD	2000	-	3.0 (1/8")	3.0 (1/8")	6.0 (1/4")	8.0 (5/16")	8.0 (5/16")	8.0 (5/16")	8.0 (5/16")	
	900	-	7.0 (9/32")	8.0 (5/16")	8.0 (5/16")	-	-	-	-	
DR450-THD/SHD	2000	-	3.0 (1/8")	3.0 (1/8")	6.0 (1/4")	6.5 (1/4")	6.5 (1/4")	6.5 (1/4")	6.5 (1/4")	
	900	-	7.0 (9/32")	8.0 (5/16")	8.0 (5/16")	-	-	-	-	
	600	-	8.0 (5/16")	10.0 (13/32")	10.0 (13/32")	8.0 (5/16")	-	-	-	
PISTOL GRIP										
DR350	20000							4.0 (5/32")	2.0 (5/64")	
	ø8-10 mm (5/16" - 3/8") cap.	5500					4.0 (5/32")	5.0 (3/16")	6.0 (1/4")	
		4500				3.0 (1/8")	6.0 (1/4")		8.0 (5/16")	
		3000				4.0 (5/32")	5.0 (3/16")	8.0 (5/16")		
		2000		3.0 (1/8")	4.0 (5/32")	6.0 (1/4")	8.0 (5/16")	10.0 (13/32")		
		1000		4.0 (5/32")	6.0 (1/4")	8.0 (5/16")				
		550	6.0 (1/4")	8.0 (5/16")						
DR500	18500							4.0 (5/32")	2.0 (5/64")	
	ø8-13 mm (5/16" - 1/2") cap.	5800					4.0 (5/32")	5.0 (3/16")	6.0 (1/4")	
		4300				3.0 (1/8")	6.0 (1/4")	10.0 (13/32")	12.0 (1/2")	
		2700			3.0 (1/8")	4.0 (5/32")	5.0 (3/16")	8.0 (5/16")	12.0 (1/2")	
		1800		3.0 (1/8")	4.0 (5/32")	6.0 (1/4")	8.0 (5/16")	10.0 (13/32")		
		1400		4.0 (5/32")	5.0 (3/16")	9.0 (11/32")	11.0 (7/16")			
		1000		5.0 (3/16")	6.0 (1/4")	10.0 (13/32")				
		600	3.0 (1/8")	7.0 (9/32")	8.0 (5/16")	12.0 (1/3")				
		400	6.0 (1/4")	8.0 (5/16")	10.0 (13/32")					
DR750	20000						2.0 (5/64")	2.0 (5/64")		
	ø8-13 mm (5/16" - 1/2") cap.	6000					4.0 (5/32")	5.0 (3/16")	6.0 (1/4")	
		4100				3.0 (1/8")	6.0 (1/4")	8.0 (5/16")	10.0 (13/32")	
		3300				3.0 (1/8")	4.0 (5/32")	8.0 (5/16")	10.0 (13/32")	
		2700			3.0 (1/8")	4.0 (5/32")	5.0 (3/16")	10.0 (13/32")	13.0* (1/2")	
		1300		4.0 (5/32")	5.0 (3/16")	9.0 (11/32")	11.0* (7/16")	19.0* (3/4")	30.0* (13/16")	
		750	3.0 (1/8")	7.0 (9/32")	8.0 (5/16")	15.0* (19/32")	19.0* (3/4")	30.0* (13/16")		
		400	6.0 (1/4")	8.0 (5/16")	10.0 (13/32")					

* above standard chuck capacity

Multi Drills



- Modular product range to boost you productivity
- Full flexibility for difficult access applications
- Lightweight and excellent ergonomics
- Robust built, reliable design and excellent run-out
- New 500W tools available in multi-drill version:
 - Pistol version with DR500-QR
 - Straight version with DR450-QR

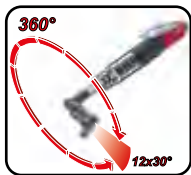

12 positions, 360° orientation

Flexibility
Excellent accessibility

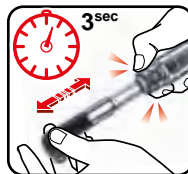

Quick-Release head

Productivity
1 tool for all applications

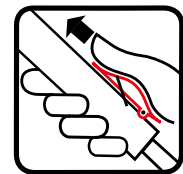

Safety
Ergonomics
Low weight
Low sound levels
Vacuum kits options



* Possibility to use ER collets with straight Quick Release attachment See p.225 for all details.

Multi-Drills



A

DR350 Series
350 W (0.5hp) / 1000 to 5500 rpm



B

DR500 Series
500 W (0.68hp) / 1000 to 5800 rpm



C

DR300 Series
300 W (0.4hp) / 550 to 5500 rpm



D

DR450 Series
450 W (0.6hp) / 1000 to 5800 rpm



***BRB**
Button + Rear Bumper
available as well as accessory



ACCESSORIES
see page 225

PIC REF	MODEL	PART NUMBER	FREE SPEED	MOTOR POWER		WEIGHT		LENGTH		AIR FLOW		AIR INLET
				rpm	W	hp	kg	lb	mm	in.	l/s	cfm
MULTI-DRILLS - PISTOL												
A	DR350-P5500-QR	205 147 984 4	5500	350	0.5	0.50	1.10	169	6.65	9.5	20	1/4
A	DR350-P4500-QR	205 147 983 4	4500	350	0.5	0.50	1.10	169	6.65	9.5	20	1/4
A	DR350-P3000-QR	205 147 528 4	3000	350	0.5	0.50	1.10	169	6.65	9.5	20	1/4
A	DR350-P1000-QR	205 147 981 4	1000	350	0.5	0.58	1.27	187	7.36	9.5	20	1/4
B	DR500-P5800-QR	615 176 190 0	5800	500	0.68	0.58	1.25	174	6.85	14	30	1/4
B	DR500-P4300-QR	615 176 189 0	4300	500	0.68	0.58	1.25	174	6.85	14	30	1/4
B	DR500-P2700-QR	615 176 188 0	2700	500	0.68	0.58	1.25	174	6.85	14	30	1/4
B	DR500-P1800-QR	615 176 187 0	1800	500	0.68	0.66	1.45	188	7.40	14	30	1/4
B	DR500-P1400-QR	615 176 186 0	1400	500	0.68	0.66	1.45	188	7.40	14	30	1/4
B	DR500-P1000-QR	615 176 185 0	1000	500	0.68	0.66	1.45	188	7.40	14	30	1/4

MULTI-DRILLS - STRAIGHT

C	DR300-T5500-QR	615 176 071 0	5500	300	0.4	0.52	1.14	179	7.05	9.5	20	1/4
C	DR300-T4500-QR	615 176 070 0	4500	300	0.4	0.52	1.14	179	7.05	9.5	20	1/4
C	DR300-T3000-QR	615 176 069 0	3000	300	0.4	0.52	1.14	179	7.05	9.5	20	1/4
C	DR300-T2000-QR	615 176 068 0	2000	300	0.4	0.52	1.14	179	7.05	9.5	20	1/4
C	DR300-T1000-QR	615 176 067 0	1000	300	0.4	0.61	1.34	195.5	7.7	9.5	20	1/4
C	DR300-T1000-QR - BRB*	615 176 118 0	1000	300	0.4	0.64	1.41	217.8	8.57	9.5	20	1/4
C	DR300-T550-QR	615 176 066 0	550	300	0.4	0.61	1.34	195.5	7.7	9.5	20	1/4
D	DR450-T5800-QR	615 176 162 0	5800	450	0.6	0.64	1.41	193	7.60	14	30	1/4
D	DR450-T4300-QR	615 176 161 0	4300	450	0.6	0.64	1.41	193	7.60	14	30	1/4
D	DR450-T2700-QR	615 176 160 0	2700	450	0.6	0.64	1.41	193	7.60	14	30	1/4
D	DR450-T1800-QR	615 176 159 0	1800	450	0.6	0.72	1.58	207	8.15	14	30	1/4
D	DR450-T1400-QR	615 176 158 0	1400	450	0.6	0.72	1.58	207	8.15	14	30	1/4
D	DR450-T1000-QR	615 176 157 0	1000	450	0.6	0.72	1.58	207	8.15	14	30	1/4

All models: Hose int. 6 mm (1/4")

Multi Drills

Quick release heads

PIC REF	DESIGNATION	PART NUMBER	LENGTH L		COLLET MAX. CAPACITY		WEIGHT	
			mm	in.	mm	in.	kg	lb
COMPACT ANGLE HEADS								
A	Short Compact 90° angle head Collet spindle	205 053 981 3	54.0	2.13	5.0	3/16	0.15	0.33
A	Compact 90° angle head Collet spindle	205 050 331 3	72.0	2.83	5.0	3/16	0.17	0.37
A	Compact 90° angle head 1/4" x 28 spindle	205 050 332 3	72.0	2.83	-	-	0.17	0.37
B	Compact 30° angle head Collet spindle	205 050 329 3	82.9	3.26	5.0	3/16	0.17	0.37
B	Compact 30° angle head 1/4" x 28 spindle	205 050 330 3	82.9	3.26	-	-	0.17	0.37
C	Compact 45° angle head Collet spindle	205 050 335 3	81.0	3.19	5.0	3/16	0.17	0.37
C	Compact 45° angle head 1/4" x 28 spindle	205 050 336 3	79.0	3.11	-	-	0.17	0.37
D	Compact 360° angle head Collet spindle	205 050 333 3	81.5	3.21	5.0	3/16	0.25	0.55
D	Compact 360° angle head 1/4" x 28 spindle	205 050 334 3	85.2	3.35	-	-	0.25	0.55
E	Short compact straight head Collet spindle	615 399 569 5	53.7	2.11	5.0	3/16	0.14	0.31
E	Short compact straight head 1/4"x28 Spindle	615 399 570 5	53.7	2.11	-	-	0.14	0.31
E	Compact straight head Collet spindle	615 399 571 5	71.7	2.82	5.0	3/16	0.16	0.35
E	Compact straight head 1/4"x28 Spindle	615 399 572 5	71.7	2.82	-	-	0.16	0.35
STANDARD ANGLE HEADS								
F	Standard 90° angle head Collet spindle	205 050 338 3	75.7	2.98	6.4	1/4	0.23	0.51
F	Standard 90° angle head Collet spindle	205 050 353 3	75.7	2.98	8.0	5/16	0.23	0.51
F	Standard 90° angle head 1/4" x 28 spindle	205 050 339 3	75.7	2.98	-	-	0.24	0.53
F	Standard 90° angle head 5/16" x 24 spindle	205 050 340 3	75.7	2.98	-	-	0.23	0.51
G	Standard 45° angle head Collet spindle	615 398 702 5	90.7	3.57	6.4	1/4	0.23	0.51
G	Standard 45° angle head 1/4" x 28 spindle	615 398 704 5	87.9	3.46	-	-	0.23	0.51
H	Standard 360° angle head Collet spindle	205 050 341 3	96.8	3.81	6.4	1/4	0.32	0.70
H	Standard 360° angle head 1/4" x 28 spindle	205 050 342 3	94.5	3.72	-	-	0.32	0.70
H	Standard 360° angle head 5/16" x 24 spindle	205 050 343 3	94.5	3.72	-	-	0.32	0.70
I	Standard straight head Collet spindle	615 399 573 5	83.8	3.3	6.4	1/4	0.2	0.44
I	Standard straight head 1/4"x28 Spindle	615 399 574 5	83.8	3.3	-	-	0.2	0.44
HEAVY DUTY HEADS								
J	QR THD 90° Collet output	615 399 575 5	48.8	1.92	8	5/16	0.31	0.68
K	QR HD 90° Cnomo	615 399 576 5	48.8	1.92	-	-	0.3	0.66
L	QR SHD 90° Chuck output	615 399 577 5	48.8	1.92	-	-	0.43	0.95
STRAIGHT HEADS								
M	Chuck mounting 3/8" x 24	205 050 543 3	32.0	1.26	-	-	0.25	0.55

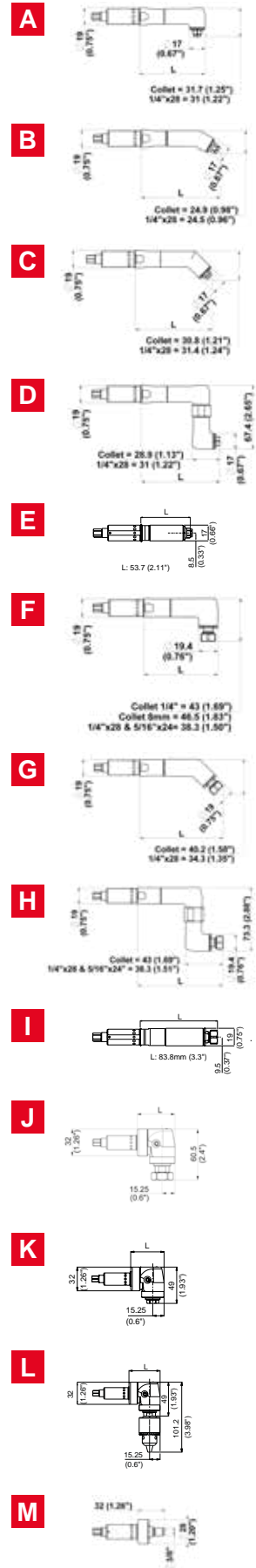

ACCESSORIES
see page 225

Multi Drills

Drilling Offset Heads

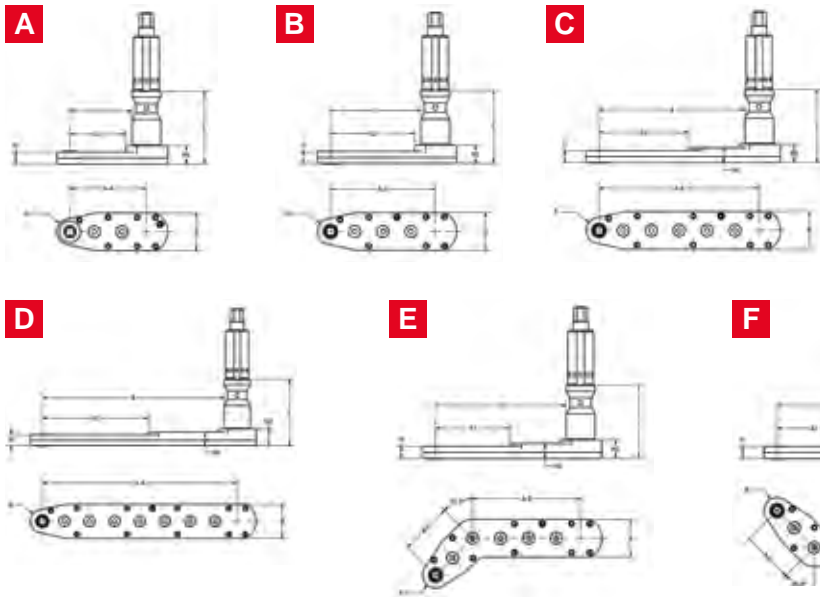

Output

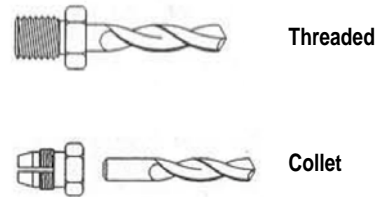

PIC REF	MODEL		DRILLING DIRECTION	MAX DRILLING CAPACITY		H		H1		H2		A		A1		A-A		A-B		A-C		B		R		L		A°
	Thread 9/32"-40	Thread 1/4"x28"		mm	in	mm	in	mm	in	mm	in	mm	in	mm	in	mm	in	mm	in	mm	in	mm	in	mm	in	mm	in	
A	DA13S3-CP2	DA13S2-CP2	Backward	5.0	3/16"	7.9	0.31	12.2	0.48	-	-	40.9	1.61	36.77	1.45	50.4	1.98	-	-	-	-	25	0.98	8.6	0.34	48.21	1.89	-
A	DA13S3-CP6	DA13S2-CP6	Backward	5.0	3/16"	7.9	0.31	12.2	0.48	-	-	40.9	1.61	36.77	1.45	50.4	1.98	-	-	-	-	25	0.98	8.6	0.34	48.21	1.89	-
A	DA23S3-CP2	DA23S2-CP2	Backward	6.35	1/4"	9.8	0.39	12.2	0.48	-	-	40.9	1.61	36.77	1.45	50.4	1.98	-	-	-	-	25	0.98	8.6	0.34	48.21	1.89	-
A	DA23S3-CP6	DA23S2-CP6	Backward	6.35	1/4"	9.8	0.39	12.2	0.48	-	-	40.9	1.61	36.77	1.45	50.4	1.98	-	-	-	-	25	0.98	8.6	0.34	48.21	1.89	-
A	DA33S3-CP2	DA33S2-CP2	Backward	8.0	5/16"	12.2	0.48	-	-	-	-	40.9	1.61	-	-	50.4	1.98	-	-	-	-	25	0.98	8.6	0.34	48.21	1.89	-
A	DA33S3-CP6	DA33S2-CP6	Backward	8.0	5/16"	12.2	0.48	-	-	-	-	40.9	1.61	-	-	50.4	1.98	-	-	-	-	25	0.98	8.6	0.34	48.21	1.89	-
B		DA04S2-CP2	Forward	3.18	1/8"	7.5	0.30	-	-	-	-	34.6	1.36	-	-	45.7	1.80	-	-	-	-	16	0.63	7.5	0.30	43.48	1.71	-
B		DA04S2-CP4	Forward	5	3/16"	7.5	0.30	-	-	-	-	34.72	1.36	-	-	45.7	1.80	-	-	-	-	16	0.63	7.5	0.30	43.48	1.71	-
B	DA14S3-CP2	DA14S2-CP2	Forward	5.0	3/16"	7.9	0.31	12.2	0.48	-	-	59.3	2.33	55.17	2.17	68.8	2.71	-	-	-	-	25	0.98	8.6	0.34	48.21	1.89	-
B	DA14S3-CP6	DA14S2-CP6	Forward	5.0	3/16"	7.9	0.31	12.2	0.48	-	-	59.3	2.33	55.17	2.17	68.8	2.71	-	-	-	-	25	0.98	8.6	0.34	48.21	1.89	-
B	DA24S3-CP2	DA24S2-CP2	Forward	6.35	1/4"	9.8	0.39	12.2	0.48	-	-	59.3	2.33	55.17	2.17	68.8	2.71	-	-	-	-	25	0.98	8.6	0.34	48.21	1.89	-
B	DA24S3-CP6	DA24S2-CP6	Forward	6.35	1/4"	9.8	0.39	12.2	0.48	-	-	59.3	2.33	55.17	2.17	68.8	2.71	-	-	-	-	25	0.98	8.6	0.34	48.21	1.89	-
B	DA34S3-CP2	DA34S2-CP2	Forward	8.0	5/16"	12.2	0.48	-	-	-	-	59.3	2.33	-	-	68.8	2.71	-	-	-	-	25	0.98	8.6	0.34	48.21	1.89	-
B	DA34S3-CP6	DA34S2-CP6	Forward	8.0	5/16"	12.2	0.48	-	-	-	-	59.3	2.33	-	-	68.8	2.71	-	-	-	-	25	0.98	8.6	0.34	48.21	1.89	-
C		DA06S2-CP2	Forward	3.18	1/8"	7.5	0.30	-	-	-	-	57.6	2.26	-	-	68.6	2.70	-	-	-	-	16	0.63	7.5	0.30	43.48	1.71	-
C		DA06S2-CP4	Forward	5.0	3/16"	7.5	0.30	-	-	-	-	57.58	2.26	-	-	68.6	2.70	-	-	-	-	16	0.63	7.5	0.30	43.48	1.71	-
C	DA16S3-CP2	DA16S2-CP2	Forward	5.0	3/16"	7.9	0.31	9.8	0.39	12.2	0.48	96.1	3.78	59.0	2.32	105.6	4.16	-	-	-	-	25	0.98	8.6	0.34	48.21	1.89	-
C	DA16S3-CP6	DA16S2-CP6	Forward	5.0	3/16"	7.9	0.31	9.8	0.39	12.2	0.48	96.1	3.78	59.0	2.32	105.6	4.16	-	-	-	-	25	0.98	8.6	0.34	48.21	1.89	-
C	DA26S3-CP2	DA26S2-CP2	Forward	6.35	1/4"	9.8	0.39	12.2	0.48	-	-	96.1	3.78	59.0	2.32	105.6	4.16	-	-	-	-	25	0.98	8.6	0.34	48.21	1.89	-
C	DA26S3-CP6	DA26S2-CP6	Forward	6.35	1/4"	9.8	0.39	12.2	0.48	-	-	96.1	3.78	59.0	2.32	105.6	4.16	-	-	-	-	25	0.98	8.6	0.34	48.21	1.89	-
C	DA36S3-CP2	DA36S2-CP2	Forward	8.0	5/16"	12.2	0.48	-	-	-	-	96.1	3.78	-	-	105.6	4.16	-	-	-	-	25	0.98	8.6	0.34	48.21	1.89	-
C	DA36S3-CP6	DA36S2-CP6	Forward	8.0	5/16"	12.2	0.48	-	-	-	-	96.1	3.78	-	-	105.6	4.16	-	-	-	-	25	0.98	8.6	0.34	48.21	1.89	-
D		DA08S2-CP2	Forward	3.18	1/8"	7.5	0.30	-	-	-	-	80.44	3.16	-	-	91.4	3.60	-	-	-	-	16	0.63	7.5	0.30	43.48	1.71	-
D	DA18S3-CP2	DA18S2-CP2	Forward	5.0	3/16"	7.9	0.31	9.8	0.39	12.2	0.48	132.9	5.23	77.4	3.05	142.4	5.61	-	-	-	-	25	0.98	8.6	0.34	48.21	1.89	-
D	DA18S3-CP6	DA18S2-CP6	Forward	5.0	3/16"	7.9	0.31	9.8	0.39	12.2	0.48	132.9	5.23	77.4	3.05	142.4	5.61	-	-	-	-	25	0.98	8.6	0.34	48.21	1.89	-
D	DA28S3-CP2	DA28S2-CP2	Forward	6.35	1/4"	9.8	0.39	12.2	0.48	-	-	132.9	5.23	77.4	3.05	142.4	5.61	-	-	-	-	25	0.98	8.6	0.34	48.21	1.89	-
D	DA28S3-CP6	DA28S2-CP6	Forward	6.35	1/4"	9.8	0.39	12.2	0.48	-	-	132.9	5.23	77.4	3.05	142.4	5.61	-	-	-	-	25	0.98	8.6	0.34	48.21	1.89	-
D	DA38S3-CP2	DA38S2-CP2	Forward	8.0	5/16"	12.2	0.48	-	-	-	-	132.9	5.23	-	-	142.4	5.61	-	-	-	-	25	0.98	8.6	0.34	48.21	1.89	-
D	DA38S3-CP6	DA38S2-CP6	Forward	8.0	5/16"	12.2	0.48	-	-	-	-	132.9	5.23	-	-	142.4	5.61	-	-	-	-	25	0.98	8.6	0.34	48.21	1.89	-
E		DA06R2-CP2	Forward	3.18	1/8"	7.5	0.30	-	-	-	-	49.41	1.94	-	-	-	-	45.7	1.80	22.9	0.90	16	0.63	7.5	0.30	43.48	1.71	50°
E		DA06R2-CP4	Forward	5.0	3/16"	7.5	0.30	-	-	-	-	49.41	1.94	-	-	-	-	45.7	1.80	22.9	0.90	16	0.63	7.5	0.30	43.48	1.71	50°
E	DA16R3-CP2	DA16R2-CP2	Forward	5.0	3/16"	7.9	0.31	9.8	0.39	12.2	0.48	86.02	3.39	59.0	2.32	-	-	71.2	2.80	34.4	1.35	25	0.98	8.6	0.34	48.21	1.89	45°
E	DA16R3-CP6	DA16R2-CP6	Forward	5.0	3/16"	7.9	0.31	9.8	0.39	12.2	0.48	86.02	3.39	59.0	2.32	-	-	71.2	2.80	34.4	1.35	25	0.98	8.6	0.34	48.21	1.89	45°
E	DA26R3-CP2	DA26R2-CP2	Forward	6.35	1/4"	9.8	0.39	12.2	0.48	-	-	86.02	3.39	59.0	2.32	-	-	71.2	2.80	34.4	1.35	25	0.98	8.6	0.34	48.21	1.89	45°
E	DA26R3-CP6	DA26R2-CP6	Forward	6.35	1/4"	9.8	0.39	12.2	0.48	-	-	86.02	3.39	59.0	2.32	-	-	71.2	2.80	34.4	1.35	25	0.98	8.6	0.34	48.21	1.89	45°
E	DA36R3-CP2	DA36R2-CP2	Forward	8.0	5/16"	12.2	0.48	-	-	-	-	86.02	3.39	-	-	-	-	71.2	2.80	34.4	1.35	25	0.98	8.6	0.34	48.21	1.89	45°
E	DA36R3-CP6	DA36R2-CP6	Forward	8.0	5/16"	12.2	0.48	-	-	-	-	86.02	3.39	-	-	-	-	71.2	2.80	34.4	1.35	25	0.98	8.6	0.34	48.21	1.89	45°
F		DA06L2-CP2	Forward	3.18	1/8"	7.5	0.30	-	-	-	-	49.41	1.94	-	-	-	-	45.7	1.80	22.9	0.90	16	0.63	7.5	0.30	43.48	1.71	50°
F		DA06L2-CP4	Forward	5.0	3/16"	7.5	0.30	-	-	-	-	49.41	1.94	-	-	-	-	45.7	1.80	22.9	0.90	16	0.63	7.5	0.30	43.48	1.71	50°
F	DA16L3-CP2	DA16L2-CP2	Forward	5.0	3/16"	7.9	0.31	9.8	0.39	12.2	0.48	86.02	3.39	59.0	2.32	-	-	71.2	2.80	34.4	1.35	25	0.98	8.6	0.34	48.21	1.89	45°
F	DA16L3-CP6	DA16L2-CP6	Forward	5.0	3/16"	7.9	0.31	9.8	0.39	12.2	0.48	86.02	3.39	59.0	2.32	-	-	71.2	2.80	34.4	1.35	25	0.98	8.6	0.34	48.21	1.89	45°
F	DA26L3-CP2	DA26L2-CP2	Forward	6.35	1/4"	9.8	0.39	12.2	0.48	-	-	86.02	3.39	59.0	2.32	-	-	71.2	2.80	34.4	1.35	25	0.98	8.6	0.34	48.21	1.89	45°
F	DA26L3-CP6	DA26L2-CP6	Forward	6.35	1/4"	9.8	0.39	12.2	0.48	-	-	86.02	3.39	59.0	2.32	-	-	71.2	2.80	34.4	1.35	25	0.98	8.6	0.34	48.21	1.89	45°
F	DA36L3-CP2	DA36L2-CP2	Forward	8.0	5/16"	12.2	0.48	-	-	-	-	86.02	3.39	-	-	-	-	71.2	2.80	34.4	1.35	25	0.98	8.6				

Multi Drills - Accessories

Collet for Compact Angle Heads: C, D, E & F (30°, 45°, 90° & 360°)



COLLET CAPACITY	PART NO.	COLLET CAPACITY	PART NO.	COLLET CAPACITY	PART NO.	COLLET CAPACITY	PART NO.	COLLET CAPACITY	PART NO.
∅ 0.8mm	2152	∅ 1.8mm	2252	∅ 2.8mm	2352	∅ 3.8mm	2452	∅ 4.8mm	2552
∅ 0.9mm	2162	∅ 1.9mm	2262	∅ 2.9mm	2362	∅ 3.9mm	2462	∅ 4.9mm	2562
∅ 1.0mm	2172	∅ 2.0mm	2272	∅ 3.0mm	2372	∅ 4.0mm	2472	∅ 5.0mm	2572
∅ 1.1mm	2182	∅ 2.1mm	2282	∅ 3.1mm	2382	∅ 4.1mm	2482		
∅ 1.2mm	2192	∅ 2.2mm	2292	∅ 3.2mm	2392	∅ 4.2mm	2492	∅ 1/16"	91442
∅ 1.3mm	2202	∅ 2.3mm	2302	∅ 3.3mm	2402	∅ 4.3mm	2502	∅ 3/32"	91452
∅ 1.4mm	2212	∅ 2.4mm	2312	∅ 3.4mm	2412	∅ 4.4mm	2512	∅ 1/8"	91462
∅ 1.5mm	2222	∅ 2.5mm	2322	∅ 3.5mm	2422	∅ 4.5mm	2522	∅ 5/32"	91472
∅ 1.6mm	2232	∅ 2.6mm	2332	∅ 3.6mm	2432	∅ 4.6mm	2532	∅ 11/64"	108172
∅ 1.7mm	2242	∅ 2.7mm	2342	∅ 3.7mm	2442	∅ 4.7mm	2542	∅ 3/16"	91482

Collet for Standard Angle Heads: G, H & J (45°, 90°, 360°)



COLLET CAPACITY	PART NO.	COLLET CAPACITY	PART NO.	COLLET CAPACITY	PART NO.	COLLET CAPACITY	PART NO.
∅ 1.6mm (1/16")	18922	∅ 3.0mm	18992	∅ 4.4mm (11/64")	19072	∅ 5.8mm	19152
∅ 1.8mm	18932	∅ 3.2mm (1/8")	19002	∅ 4.6mm	19082	∅ 6.0mm (15/64")	19162
∅ 2.0mm (5/64")	18942	∅ 3.4mm	19022	∅ 4.8mm (3/16")	19092	∅ 6.2mm	19172
∅ 2.2mm	18952	∅ 3.6mm (9/64")	19032	∅ 5.0mm	19102	∅ 6.4mm (1/4")	19182
∅ 2.4mm	18962	∅ 3.8mm	19042	∅ 5.2mm (13/64")	19122		
∅ 2.6mm	18972	∅ 4.0mm (5/32")	19052	∅ 5.4mm	19132		
∅ 2.8mm (7/64")	18982	∅ 4.2mm	19062	∅ 5.6mm (7/32")	19142		

Collet for Standard Angle Head: P.N. 205 050 353 3



COLLET CAPACITY	PART NO.	COLLET CAPACITY	PART NO.	COLLET CAPACITY	PART NO.	COLLET CAPACITY	PART NO.
∅ 2.0mm	615 526 066 0	∅ 4.0mm	615 526 071 0	∅ 5.9mm	615 526 078 0	∅ 7.5mm	615 526 084 0
∅ 2.4mm	615 526 067 0	∅ 4.5mm	615 526 073 0	∅ 6.0mm	615 526 079 0	∅ 7.7mm	615 526 085 0
∅ 2.5mm	615 526 068 0	∅ 5.0mm	615 526 075 0	∅ 6.3mm	615 526 080 0	∅ 7.9mm	615 526 087 0
∅ 3.0mm	615 526 069 0	∅ 5.2mm	615 526 076 0	∅ 6.5mm	615 526 081 0	∅ 8.0mm	615 526 088 0
∅ 3.5mm	615 526 070 0	∅ 5.5mm	615 526 077 0	∅ 7.0mm	615 526 083 0		



ACCESSORIES INCLUDED

ITEM	PART NO.
With DR300	
2 Safety lever	205 051 259 3
With Angle heads C, D, E & F	
3 Collet ∅ 4.8mm (3/16") capacity	2552
• Flat wrench	615 802 069 0
• Flat wrench	615 802 070 0
With Angle heads G & H	
4 Collet ∅ 6.4mm (1/4") capacity	19182
• Flat wrenches 10mm	82623
With DR300/350/450/500	
5 Set of color plastic rings	615 399 250 0

OTHER OPTIONAL ACCESSORIES

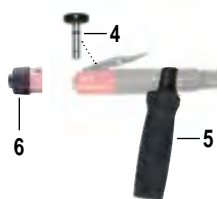

ITEM	PART NO.
1 Short lever	205 050 299 3
4 Start button	615 399 266 0
5 Side handle	615 399 265 0
• Keyed chuck C6 - 3/8"x24 (Cap. 0.5 to 6.5mm)	205 055 272 3
• Keyed chuck C8 - 3/8"x24 (Cap. 0.5 to 8mm)	205 053 013 3
• Flat wrenches 8-9.5mm for Angle heads C, D, E & F	268263
6 Kit silencer NPT	615 399 313 0
6 Kit silencer BSP	615 399 311 0
6 Kit Bumper	615 399 312 0

Angle Drills

Compact Head - Max capacity: 5mm (3/16")
Collet & 1/4" x 28 Spindle



A DR300-T...-T/S5-30 Series
300 W (0.4hp) / 1000 to 5500 rpm



B DR300-T...-T/S5-45 Series
300 W (0.4hp) / 550 to 5500 rpm



C DR300-T...-T/S5-90 Series
300 W (0.4hp) / 1000 to 5500 rpm



D DR300-T...-T/S5-360 Series
300 W (0.4hp) / 1000 to 5500 rpm

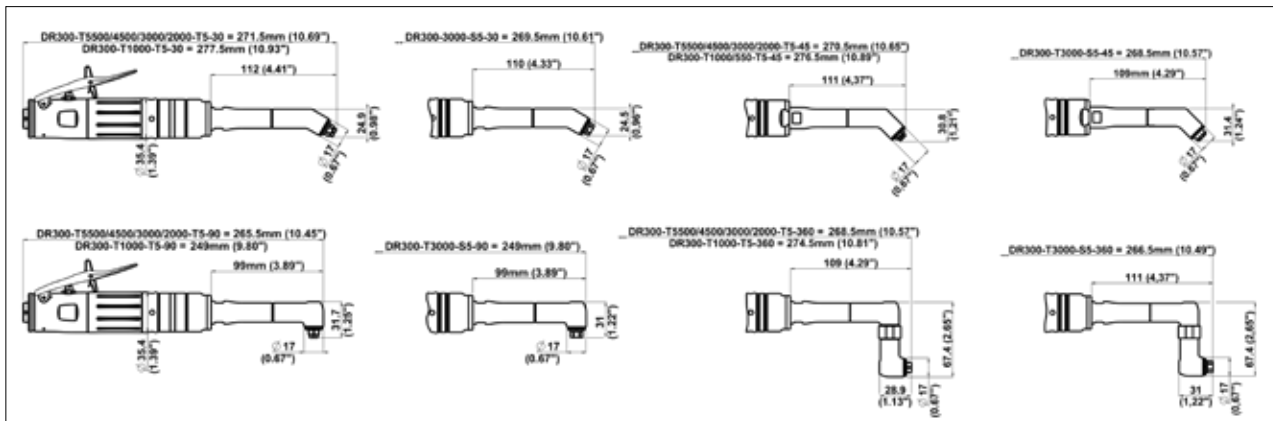

***BRB**
Button + Rear Bumper
available as well as accessory



ACCESSORIES
see page 229

PIC REF	MODEL	PART NUMBER	MODEL	PART NUMBER	FREE SPEED	MOTOR POWER		WEIGHT						
						rpm	W	hp	kg	lb				
30° - COLLET SPINDLE					30° - 1/4" x 28 SPINDLE					Max. capacity: 5mm (3/16")				
A	DR300-T5500-T5-30	615 176 077 0	DR300-T5500-S5-30	615 176 133 0	5500	300	0.4	0.66	1.45					
A	DR300-T4500-T5-30	615 176 076 0	DR300-T4500-S5-30	615 176 132 0	4500	300	0.4	0.66	1.45					
A	DR300-T3000-T5-30	615 176 074 0	DR300-T3000-S5-30	615 176 075 0	3000	300	0.4	0.66	1.45					
A	DR300-T3000-T5-30 - BRB*	615 176 119 0			3000	300	0.4	0.66	1.45					
A	DR300-T2000-T5-30	615 176 073 0	DR300-T2000-S5-30	615 176 131 0	2000	300	0.4	0.66	1.45					
A	DR300-T1000-T5-30	615 176 072 0	DR300-T1000-S5-30	615 176 130 0	1000	300	0.4	0.76	1.67					
45° - COLLET SPINDLE					45° - 1/4" x 28 SPINDLE					Max. capacity: 5mm (3/16")				
B	DR300-T5500-T5-45	615 176 096 0	DR300-T5500-S5-45	615 176 146 0	5500	300	0.4	0.67	1.47					
B	DR300-T4500-T5-45	615 176 095 0	DR300-T4500-S5-45	615 176 145 0	4500	300	0.4	0.67	1.47					
B	DR300-T3000-T5-45	615 176 093 0	DR300-T3000-S5-45	615 176 094 0	3000	300	0.4	0.67	1.47					
B	DR300-T2000-T5-45	615 176 092 0	DR300-T2000-S5-45	615 176 144 0	2000	300	0.4	0.67	1.47					
B	DR300-T1000-T5-45	615 176 091 0	DR300-T1000-S5-45	615 176 143 0	1000	300	0.4	0.76	1.67					
B	DR300-T550-T5-45	615 176 090 0	DR300-T550-S5-45	615 176 142 0	550	300	0.4	0.76	1.67					
90° - COLLET SPINDLE					90° - 1/4" x 28 SPINDLE					Max. capacity: 5mm (3/16")				
C	DR300-T5500-T5-90	615 176 083 0	DR300-T5500-S5-90	615 176 137 0	5500	300	0.4	0.68	1.5					
C	DR300-T4500-T5-90	615 176 082 0	DR300-T4500-S5-90	615 176 136 0	4500	300	0.4	0.68	1.5					
C	DR300-T4500-T5-90 - BRB*	615 176 120 0			4500	300	0.4	0.68	1.5					
C	DR300-T3000-T5-90	615 176 080 0	DR300-T3000-S5-90	615 176 081 0	3000	300	0.4	0.68	1.5					
C	DR300-T2000-T5-90	615 176 079 0	DR300-T2000-S5-90	615 176 135 0	2000	300	0.4	0.68	1.5					
C	DR300-T1000-T5-90	615 176 078 0	DR300-T1000-S5-90	615 176 134 0	1000	300	0.4	0.78	1.72					
360° - COLLET SPINDLE					360° - 1/4" x 28 SPINDLE					Max. capacity: 5mm (3/16")				
D	DR300-T5500-T5-360	615 176 089 0	DR300-T5500-S5-360	615 176 141 0	5500	300	0.4	0.74	1.63					
D	DR300-T4500-T5-360	615 176 088 0	DR300-T4500-S5-360	615 176 140 0	4500	300	0.4	0.74	1.63					
D	DR300-T3000-T5-360	615 176 086 0	DR300-T3000-S5-360	615 176 087 0	3000	300	0.4	0.74	1.63					
D	DR300-T2000-T5-360	615 176 085 0	DR300-T2000-S5-360	615 176 139 0	2000	300	0.4	0.74	1.63					
D	DR300-T1000-T5-360	615 176 084 0	DR300-T1000-S5-360	615 176 138 0	1000	300	0.4	0.84	1.85					

All models: Air flow: 9.5 l/s (20 cfm) - Air inlet 1/4" - Hose int. 6 mm (1/4")

Angle Drills

Standard Head - Max capacity: 6.4mm (1/4")
Collet & 1/4" x 28 Spindle



A DR300-T...-T/S6-90 Series
300 W (0.4hp) / 550 to 5500 rpm



C DR300-T...-T/S6-360 Series
300 W (0.4hp) / 550 to 5500 rpm



B DR450-T...-T/S6-90 Series
450 W (0.6hp) / 1400 to 5800 rpm

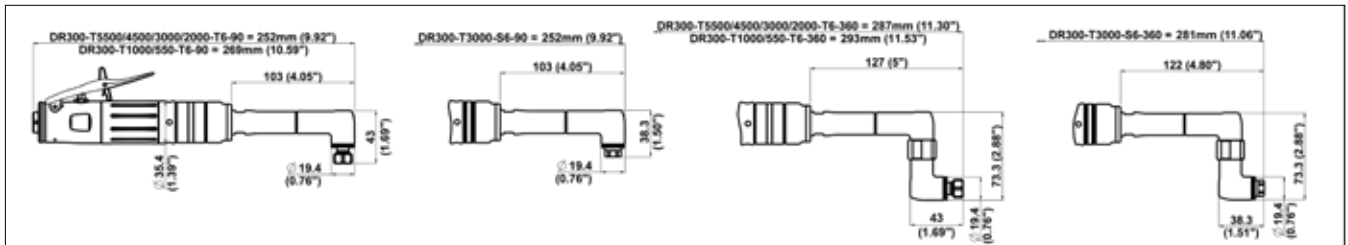

***BRB**
Button + Rear Bumper
available as well as accessory



ACCESSORIES
see page 229

PIC REF	MODEL	PART NUMBER	MODEL	PART NUMBER	FREE SPEED		MOTOR POWER		WEIGHT	
					rpm		W	hp	kg	lb
90° - COLLET SPINDLE			90° - 1/4" x 28 SPINDLE		Max. capacity: 6.4mm (1/4")					
A	DR300-T5500-T6-90	615 176 103 0	DR300-T5500-S6-90	615 176 151 0	5500	300	0.4	0.7	1.54	
A	DR300-T4500-T6-90	615 176 102 0	DR300-T4500-S6-90	615 176 150 0	4500	300	0.4	0.7	1.54	
A	DR300-T4500-T6-90 - BRB*	615 176 124 0	DR300-T3000-S6-90	615 176 101 0	3000	300	0.4	0.7	1.54	
A	DR300-T3000-T6-90	615 176 100 0	DR300-T2000-S6-90	615 176 149 0	2000	300	0.4	0.7	1.54	
A	DR300-T3000-T6-90 - BRB*	615 176 123 0	DR300-T1000-S6-90	615 176 148 0	1000	300	0.4	0.79	1.74	
A	DR300-T2000-T6-90	615 176 099 0	DR300-T550-S6-90	615 176 147 0	550	300	0.4	0.79	1.74	
A	DR300-T2000-T6-90 - BRB*	615 176 122 0			1000	300	0.4	0.82	1.81	
A	DR300-T1000-T6-90	615 176 098 0			2000	300	0.4	0.72	1.59	
A	DR300-T1000-T6-90 - BRB*	615 176 121 0			3000	300	0.4	0.72	1.59	
A	DR300-T550-T6-90	615 176 097 0			4500	300	0.4	0.72	1.59	
B	DR450-T5800-T6-90	615 176 167 0	DR450-T5800-S6-90	615 176 172 0	5800	450	0.6	0.76	1.67	
B	DR450-T4300-T6-90	615 176 166 0	DR450-T4300-S6-90	615 176 171 0	4300	450	0.6	0.76	1.67	
B	DR450-T2700-T6-90	615 176 165 0	DR450-T2700-S6-90	615 176 170 0	2700	450	0.6	0.76	1.67	
B	DR450-T1800-T6-90	615 176 164 0	DR450-T1800-S6-90	615 176 169 0	1800	450	0.6	0.85	1.87	
B	DR450-T1400-T6-90	615 176 163 0	DR450-T1400-S6-90	615 176 168 0	1400	450	0.6	0.85	1.87	
360° - COLLET SPINDLE			360° - 1/4" x 28 SPINDLE		Max. capacity: 6.4mm (1/4")					
C	DR300-T5500-T6-360	615 176 110 0	DR300-T5500-S6-360	615 176 156 0	5500	300	0.4	0.82	1.81	
C	DR300-T4500-T6-360	615 176 109 0	DR300-T4500-S6-360	615 176 155 0	4500	300	0.4	0.82	1.81	
C	DR300-T3000-T6-360	615 176 107 0	DR300-T3000-S6-360	615 176 108 0	3000	300	0.4	0.82	1.81	
C	DR300-T3000-T6-360 - BRB*	615 176 125 0	DR300-T2000-S6-360	615 176 154 0	2000	300	0.4	0.82	1.81	
C	DR300-T2000-T6-360	615 176 106 0	DR300-T1000-S6-360	615 176 153 0	1000	300	0.4	0.91	2	
C	DR300-T1000-T6-360	615 176 105 0	DR300-T550-S6-360	615 176 152 0	550	300	0.4	0.91	2	
C	DR300-T550-T6-360	615 176 104 0			3000	300	0.4	0.72	1.59	

All models: Air flow: 9.5 l/s (20 cfm) - Air inlet 1/4" - Hose int. 6 mm (1/4")

Angle Drills

Heavy Duty 90° Angle Head



A

DR300-T...-THD-90 Series
300 W (0.4hp) / 900 & 2000 rpm



B

DR300-T...-SHD-90 Series
300 W (0.4hp) / 900 & 2000 rpm



C

DR450-T...-THD-90 Series
300 W (0.4hp) / 900 & 2000 rpm



D

DR450-T...-SHD-90 Series
300 W (0.4hp) / 900 & 2000 rpm

PIC REF	MODEL	PART NUMBER	FREE SPEED	MOTOR POWER		WEIGHT		LENGTH		AIR FLOW		AIR INLET
				rpm	W	hp	kg	lb	mm	in.	l/s	
90° - COLLET SPINDLE Max capacity: 8mm (5/16")												
A	DR300-T2000-THD-90	615 176 111 0	2000	300	0.4	0.73	1.61	189.5	7.46	9.5	20	1/4
A	DR300-T900-THD-90	615 176 112 0	900	300	0.4	0.83	1.83	206	8.11	9.5	20	1/4
A	DR300-T600-THD-90	615 176 116 0	600	300	0.4	0.83	1.83	206	8.11	9.5	20	1/4
C	DR450-T3000-THD-90	615 176 176 0	3000	450	0.6	0.8	1.76	191.5	7.54	14	30	1/4
C	DR450-T1800-THD-90	615 176 175 0	1800	450	0.6	0.8	1.76	191.5	7.54	14	30	1/4
C	DR450-T1000-THD-90	615 176 174 0	1000	450	0.6	0.89	1.96	205.5	8.09	14	30	1/4
C	DR450-T650-THD-90	615 176 173 0	650	450	0.6	0.89	1.96	205.5	8.09	14	30	1/4
90° - KEY CHUCK Max capacity: 8mm (5/16")												
B	DR300-T2000-SHD-90	615 176 113 0	2000	300	0.4	0.86	1.89	189.5	7.46	9.5	20	1/4
B	DR300-T900-SHD-90	615 176 114 0	900	300	0.4	0.96	2.11	206	8.11	9.5	20	1/4
B	DR300-T600-SHD-90	615 176 117 0	600	300	0.4	0.96	2.11	206	8.11	9.5	20	1/4
D	DR450-T3000-SHD-90	615 176 180 0	3000	450	0.6	0.92	2.03	191.5	7.54	14	30	1/4
D	DR450-T1800-SHD-90	615 176 179 0	1800	450	0.6	0.92	2.03	191.5	7.54	14	30	1/4
D	DR450-T1000-SHD-90	615 176 178 0	1000	450	0.6	1.02	2.25	205.5	8.09	14	30	1/4
D	DR450-T650-SHD-90	615 176 177 0	650	450	0.6	1.02	2.25	205.5	8.09	14	30	1/4

All models: Air flow: Hose int. 6 mm (1/4")



Accessories for Angle Drills

Collet for Compact Angle Drills DR300-T5.. - Maximum capacity: 5 mm (3/16")



COLLET CAPACITY	PART NO.	COLLET CAPACITY	PART NO.	COLLET CAPACITY	PART NO.	COLLET CAPACITY	PART NO.	COLLET CAPACITY	PART NO.
∅ 0.8mm	2152	∅ 1.8mm	2252	∅ 2.8mm	2352	∅ 3.8mm	2452	∅ 4.8mm	2552
∅ 0.9mm	2162	∅ 1.9mm	2262	∅ 2.9mm	2362	∅ 3.9mm	2462	∅ 4.9mm	2562
∅ 1.0mm	2172	∅ 2.0mm	2272	∅ 3.0mm	2372	∅ 4.0mm	2472	∅ 5.0mm	2572
∅ 1.1mm	2182	∅ 2.1mm	2282	∅ 3.1mm	2382	∅ 4.1mm	2482	∅ 1/16"	91442
∅ 1.2mm	2192	∅ 2.2mm	2292	∅ 3.2mm	2392	∅ 4.2mm	2492	∅ 3/32"	91452
∅ 1.3mm	2202	∅ 2.3mm	2302	∅ 3.3mm	2402	∅ 4.3mm	2502	∅ 1/8"	91462
∅ 1.4mm	2212	∅ 2.4mm	2312	∅ 3.4mm	2412	∅ 4.4mm	2512	∅ 5/32"	91472
∅ 1.5mm	2222	∅ 2.5mm	2322	∅ 3.5mm	2422	∅ 4.5mm	2522	∅ 11/64"	108172
∅ 1.6mm	2232	∅ 2.6mm	2332	∅ 3.6mm	2432	∅ 4.6mm	2532	∅ 3/16"	91482
∅ 1.7mm	2242	∅ 2.7mm	2342	∅ 3.7mm	2442	∅ 4.7mm	2542		

Collet for Standard Angle Drills DR300-T6.. - Maximum capacity: 6.4 mm (1/4")



COLLET CAPACITY	PART NO.	COLLET CAPACITY	PART NO.	COLLET CAPACITY	PART NO.	COLLET CAPACITY	PART NO.
∅ 1.6mm (1/16")	18922	∅ 3.0mm	18992	∅ 4.4mm (11/64")	19072	∅ 5.8mm	19152
∅ 1.8mm	18932	∅ 3.2mm (1/8")	19002	∅ 4.6mm	19082	∅ 6.0mm (15/64")	19162
∅ 2.0mm (5/64")	18942	∅ 3.4mm	19022	∅ 4.8mm (3/16")	19092	∅ 6.2mm	19172
∅ 2.2mm	18952	∅ 3.6mm (9/64")	19032	∅ 5.0mm	19102	∅ 6.4mm (1/4")	19182
∅ 2.4mm	18962	∅ 3.8mm	19042	∅ 5.2mm (13/64")	19122		
∅ 2.6mm	18972	∅ 4.0mm (5/32")	19052	∅ 5.4mm	19132		
∅ 2.8mm (7/64")	18982	∅ 4.2mm	19062	∅ 5.6mm (7/32")	19142		

Collet for Heavy Duty Angle Drills DR300-THD.. - Maximum capacity: 8 mm (5/16")



COLLET CAPACITY	PART NO.	COLLET CAPACITY	PART NO.	COLLET CAPACITY	PART NO.	COLLET CAPACITY	PART NO.
∅ 2.4mm (3/32")	2592	∅ 4.0mm (5/32")	2672	∅ 5.6mm	2752	∅ 7.2mm	2832
∅ 2.6mm	2602	∅ 4.2mm	2682	∅ 5.8mm	2762	∅ 7.4mm	2842
∅ 2.8mm (7/64")	2612	∅ 4.4mm	2692	∅ 6.0mm	2772	∅ 7.6mm	2852
∅ 3.0mm	2622	∅ 4.6mm	2702	∅ 6.2mm	2782	∅ 7.8mm	2862
∅ 3.2mm (1/8")	2632	∅ 4.8mm (3/16")	2712	∅ 6.4 (1/4")	2792	∅ 8.0mm (5/16")	2872
∅ 3.4mm	2642	∅ 5.0mm	2722	∅ 6.6mm	2802		
∅ 3.6mm (9/64")	2652	∅ 5.2mm	2732	∅ 6.8mm	2812		
∅ 3.8mm	2662	∅ 5.4mm	2742	∅ 7.0mm	2822		

ACCESSORIES INCLUDED

ITEM	COMPACT DR300-T5..		STANDARD DR300-T6..		COMPACT DR300-S5		STANDARD DR300-S6		HEAVY DUTY DR300-THD		DR300-SHD
	COLLET SPINDLE		COLLET SPINDLE		1/4" X 28 SPINDLE		COLLET		COLLET		CHUCK
1	∅ 4.8mm (3/16") capacity collet		2552								
2	∅ 6.4mm (1/4") capacity collet		19182								
3	∅ 8mm (5/16") capacity collet								2872		
4	Chuck threaded 3/8" UNF - cap 8mm (5/16") with key										205 053 013 3
.	Chuck key										410213
5	Safety lever		205 051 259 3	205 051 259 3	205 051 259 3	205 051 259 3	205 051 259 3	205 051 259 3	205 051 259 3	205 051 259 3	
	• Flat wrench 8-9.5mm		268263								
	• Flat wrenches 10mm		82623								

OTHER OPTIONAL ACCESSORIES

ITEM	DR300-T5.. DR300-S5..	DR300-T6.. DR300-S6..	DR300-THD..	DR300-SHD..
6	Inlet button with lever recess plugs		615 399 266 0	615 399 266 0
7	Short lever		205 050 299 3	205 050 299 3
8	Side handle			615 399 265 0
9	Kit silencer NPT		615 399 313 0	615 399 313 0
9	Kit silencer BSP		615 399 311 0	615 399 311 0
9	Kit Bumper		615 399 312 0	615 399 312 0





Pistol Grip Drills



■ Wide range of pistol drills with best in class power-to-weight ratio

■ How to make the right selection?

  <p>1 Material drilled</p>	 <p>2 Diameter</p>	 <p>3 Tool power & speed</p>	 <p>4 Accessory for each application</p>
---	--	---	--

■ Tool range

Our range covers a wide range of applications to answer all your requirements



Pistol Grip Drills



A
DR350 Series
350 W (0.5hp) / 550 to 20000 rpm



B
DR500 Series
500 W (0.68hp) / 400 to 18500 rpm



C
DR750 Series
750 W (1hp) / 400 to 20000 rpm



D

Color rings to identify your tools speed



Model	D		H	
	mm	in.	mm	in.
DR350-P..	35	1.38	135	5.3
DR500-P	36.5	1.44	135	5.3
DR750-P..	47	1.85	146	5.75

PIC REF	MODEL	PART NUMBER	MODEL	PART NUMBER	FREE SPEED	MOTOR POWER		STALL TORQUE		WEIGHT W/O CHUCK		LENGTH L	
						W	hp	Nm	in.lb	kg	lb	mm	in.
DR350 - KEY CHUCK					DR350 - WITHOUT CHUCK								
A	DR350-P20000-C8	205 147 252 4	DR350-P20000*	205 147 359 4	20000	350	0.5	0.6	5.3	0.49	1.1	120	4.72
A	DR350-P5500-C8	205 147 250 4	DR350-P5500*	205 147 358 4	5500	350	0.5	2.3	20.4	0.49	1.1	136	5.35
A	DR350-P4500-C8	205 147 382 4	DR350-P4500*	205 147 384 4	4500	350	0.5	2.7	23.9	0.49	1.1	136	5.35
A	DR350-P3000-C8	205 147 248 4	DR350-P3000*	205 147 357 4	3000	350	0.5	4.0	35.4	0.49	1.1	136	5.35
A	DR350-P2000-C8	205 147 246 4	DR350-P2000*	205 147 356 4	2000	350	0.5	5.4	47.8	0.49	1.1	136	5.35
A	DR350-P1000-C10	205 147 244 4	DR350-P1000*	205 147 355 4	1000	350	0.5	12.7	112.4	0.57	1.3	154	6.06
A	DR350-P550-C10	205 147 242 4	DR350-P550*	205 147 354 4	550	350	0.5	18.6	164.6	0.57	1.3	154	6.06

All models DR350: Air Flow: 9.5 l/s (20 cfm) - Air Inlet 1/4" - Hose int. 6 mm (1/4") / * Chuck spindle 3/8" x 24 UNF

PIC REF	MODEL	PART NUMBER	MODEL	PART NUMBER	FREE SPEED	MOTOR POWER		STALL TORQUE		WEIGHT W/O CHUCK		LENGTH L	
						W	hp	Nm	in.lb	kg	lb	mm	in.
DR500 - KEY CHUCK					DR500 - WITHOUT CHUCK								
B	DR500-P18500-C8	205 147 676 4	DR500-P18500*	205 147 678 4	18500	500	0.68	1.0	8.85	0.56	1.2	141	5.55
B	DR500-P5800-C8	205 147 673 4	DR500-P5800*	205 147 675 4	5800	500	0.68	3.1	27.4	0.56	1.2	141	5.55
B	DR500-P4300-C8	205 147 670 4	DR500-P4300*	205 147 672 4	4300	500	0.68	4.2	37.2	0.56	1.2	141	5.55
B	DR500-P2700-C8	205 147 667 4	DR500-P2700*	205 147 669 4	2700	500	0.68	6.9	61.1	0.56	1.2	141	5.55
B	DR500-P1800-C10	205 147 664 4	DR500-P1800*	205 147 666 4	1800	500	0.68	9.9	87.6	0.64	1.4	155	6.1
B	DR500-P1400-C10	205 147 661 4	DR500-P1400*	205 147 663 4	1400	500	0.68	13.4	118.6	0.64	1.4	155	6.1
B	DR500-P1000-C10	205 147 658 4	DR500-P1000*	205 147 660 4	1000	500	0.68	18.0	159	0.64	1.4	155	6.1
B	DR500-P600-C13	205 147 655 4	DR500-P600*	205 147 657 4	600	500	0.68	28.7	254	0.64	1.4	155	6.1
B	DR500-P400-C13	205 147 652 4	DR500-P400*	205 147 654 4	400	500	0.68	46.0	407	0.64	1.4	155	6.1

All models DR500: Air Flow: 14 l/s (30 cfm) - Air inlet: 1/4" - Hose int. 10 mm (3/8") / * Chuck spindle 3/8" x 24 UNF

PIC REF	MODEL	PART NUMBER	MODEL	PART NUMBER	FREE SPEED	MOTOR POWER		STALL TORQUE		WEIGHT W/O CHUCK		LENGTH L	
						W	hp	Nm	in.lb	kg	lb	mm	in.
DR750 - KEY CHUCK					DR750 - WITHOUT CHUCK								
C	DR750-P20000-C8	205 146 659 4	DR750-P20000*	205 147 458 4	20000	750	1	1.6	14.2	0.9	2.0	152	5.98
C	DR750-P6000-C8	1465124	DR750-P6000*	205 147 417 4	6000	750	1	5.3	46.9	0.9	2.0	152	5.98
C	DR750-P4100-C8	1465114	DR750-P4100*	205 147 456 4	4100	750	1	7.1	62.8	0.9	2.0	152	5.98
C	DR750-P3300-C10	1465104	DR750-P3300*	205 147 455 4	3300	750	1	9.6	85.0	0.9	2.0	152	5.98
C	DR750-P2700-C10	1465094	DR750-P2700*	205 147 416 4	2700	750	1	11.1	98.2	0.9	2.0	152	5.98
C	DR750-P1300-C10	1465084	DR750-P1300*	205 147 415 4	1300	750	1	23.9	211	1.15	2.5	184	7.24
C	DR750-P750-C13	1465074	DR750-P750**	205 147 452 4	750	750	1	41.0	363	1.15	2.5	184	7.24
C	DR750-P400-C13	205 146 658 4	DR750-P400**	205 147 451 4	400	750	1	55.0	487	1.15	2.5	184	7.24

DR750 - JACOBS TAPER 1 SPINDLE - WITHOUT CHUCK

D	DR750-P20000-JT1	205 146 667 4	20000	750	1	1.6	14.2	0.9	2.0	152	5.98
D	DR750-P6000-JT1	205 146 666 4	6000	750	1	5.3	46.9	0.9	2.0	152	5.98
D	DR750-P3300-JT1	205 146 664 4	3300	750	1	9.6	85.0	0.9	2.0	152	5.98
D	DR750-P2700-JT1	205 146 663 4	2700	750	1	11.1	98.2	0.9	2.0	152	5.98
D	DR750-P1300-JT1	205 146 662 4	1300	750	1	23.9	211	1.15	2.5	184	7.24
D	DR750-P750-JT1	205 146 661 4	750	750	1	41.0	363	1.15	2.5	184	7.24
D	DR750-P400-JT1	205 146 660 4	400	750	1	55.0	487	1.15	2.5	184	7.24

All models DR750: Air Flow: 14 l/s (30 cfm) - Air inlet: 1/4" - Hose int. 10 mm (3/8") / Chuck spindle: * 3/8" x 24 UNF / **1/2" x 20 UNF



Accessories

CHUCK SELECTION GUIDE FOR DR300-T... / DR350-P... / DR500-P... / DR750-P.

CHUCK PART NO.	CHUCK MOUNT	CHUCK CAPACITY		DIMENSIONS				WEIGHT		PART NO. KEY	DR3...P...C8	DR3...P...C10	DR500-P...C13	DR750-P..
		mm	in.	D1		L1		g	lb		DR500-P...C8	DR500-P...C10	DR750-P...C13	JT1
205 055 272 3	3/8"-24	0.5 - 6.5	1/4	29.3	1.15	42.5	1.67	121	0.27	29182	O	O	O	
205 053 013 3	3/8"-24	0.5 - 8	5/16	29.3	1.15	42.5	1.67	120	0.26	410213	L			
205 052 954 3	3/8"-24	1 - 10	3/8	37	1.46	49.5	1.95	204	0.45	29232		L		
473113	3/8"-24	1.5 - 13	1/2	42	1.67	59	2.32	371	0.82	895 101 145 3			L	
29142	1/2"-20	1.5 - 13	1/2	42	1.67	59	2.32	362	0.80	895 101 145 3			L	
29492	1JT	0.5 - 6.5	1/4	29.3	1.15	42.5	1.67	112	0.25	29182				O
29042	1JT	0.8 - 10	3/8	34.5	1.36	48	1.89	231	0.51	29232				O
34752	2JT	1 - 10	3/8	42	1.67	61.5	2.4	386	0.85	895 101 145 3				O*
34332	2JT	1 - 13	1/2	50	1.97	67.5	2.66	900	1.98					O*
473433	3/8"-24	0 - 8	5/16	32	1.26	61.5	2.4	285	0.63		O	O		
473423	3/8"-24	0.5 - 10	3/8	35.8	1.4	66	2.6	390	0.86			O		
205 047 819 3	3/8"-24	1 - 13	1/2	40	1.58	76.3	3	559	1.23				O	
205 056 060 3	1/2"-20	1 - 13	1/2	40	1.58	76.3	3	548	1.21				O	
524.09	1JT	0 - 6.5	1/4	32	1.26	59.5	2.34	284	0.62					O
524.15	1JT	0.5 - 10	3/8	35.8	1.4	66	2.6	390	0.86					O
524.10	2JT	0.5 - 10	3/8	40	1.58	87.5	3.4	636	1.4					O*
524.16	2JT	1 - 13	1/2	46	1.8	91	3.6	904	1.99					O*

* To use 2JT chuck on DR750, add adaptor P.N. 12243

- | INCLUDED WITH THE TOOL
- O OPTIONAL ACCESSORIES

ACCESSORIES INCLUDED		DR350-P...C8 DR500-P...C8 DR750-P...C8.	DR350-P...C10 DR500-P...C10 DR750-P...C10	DR500-P...C13 DR750-P...C13
1	Chuck guard for DR350-P...C	205 049 275 3		
1	Chuck guard for DR500-P...C	205 049 486 3		
1	Chuck guard for DR750-P...C8 & C10	473143	473143	
2	Side handle for DR350-P550 & P1000	205 049 446 3	205 049 446 3	
2	Side handle for DR500-P400 to P1800		205 053 102 3	205 053 102 3
2	Side handle for DR750-P	473173	473173	473173
3	Suspension bail for DR750-P	473153	473153	473153
With DR300/350/450/500				
4	Set of color plastic rings	615 399 250 0		

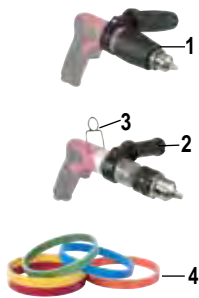

OTHER OPTIONAL ACCESSORIES

ITEM	DR350-P...	DR500-P...	DR750-P...	DR750-P...JT1 MOUNT
•	Chuck guard for DR750-P...JT1 with chuck key - cap 6.5mm (1/4")			473143
2	205 049 446 3	205 053 102 3		
•	Adaptor - JT1 female to JT2 male (for DR750-P...JT1)			12243
•	Flat wrench, 12.7mm (1/2")			15533



Straight Grip Drills



A

DR300 Series
300 W (0.4hp) / 550 to 20000 rpm

PIC REF	MODEL	PART NUMBER	MODEL	PART NUMBER	FREE SPEED		MOTOR POWER		STALL TORQUE		WEIGHT W/O CHUCK		LENGHT W/O CHUCK	
					rpm		W	hp	Nm	in.lb	kg	lb	mm	in.
DR300 - KEY CHUCK					DR300 - WITHOUT CHUCK									
A	DR300-T20000-C8	615 176 065 0	DR300-T20000	615 176 064 0	20000	300	0.4	0.6	5.3	0.44	0.97	138	7.28	
A	DR300-T5500-C8	615 176 063 0	DR300-T5500	615 176 062 0	5500	300	0.4	2.3	20.4	0.49	1.08	167	6.57	
A	DR300-T4500-C8	615 176 061 0	DR300-T4500	615 176 060 0	4500	300	0.4	2.7	23.9	0.49	1.08	167	6.57	
A	DR300-T3000-C8	615 176 059 0	DR300-T3000	615 176 058 0	3000	300	0.4	4.0	35.4	0.49	1.08	167	6.57	
A	DR300-T2000-C8	615 176 057 0	DR300-T2000	615 176 056 0	2000	300	0.4	5.4	47.8	0.49	1.08	167	6.57	
A	DR300-T1000-C10	615 176 055 0	DR300-T1000	615 176 054 0	1000	300	0.4	12.7	112.4	0.60	1.32	184	7.24	
A	DR300-T550-C10	615 176 053 0	DR300-T550	615 176 052 0	550	300	0.4	18.6	164.6	0.60	1.32	184	7.24	

All models DR300: Air Flow: 9.5 l/s (20 cfm) - Air Inlet 1/4" - Hose int. 6 mm (1/4") / Chuck spindle 3/8" x 24 UNF



ACCESSORIES INCLUDED

ITEM	DR300-P...C8	DR300-P...C10
1 Keyed chuck 3/8" UNF - cap 8mm (5/16") (with key)	205 053 013 3	-
1 Keyed chuck 3/8" UNF - cap 10mm (3/8") (with key)	-	205 052 954 3
• Chuck key	410213	29232
2 Chuck guard for DR300-P...C8	615 049 275 3	-
3 Side handle for DR300-T...C10	-	205 049 446 3
4 Safety lever for DR300-T...	205 050 288 3	205 050 288 3
• Exhaust hose for DR300-T...	205 051 259 3	205 051 259 3



DESCRIPTION	PART NO.
DR300 Set of color plastic rings	615 399 250 0

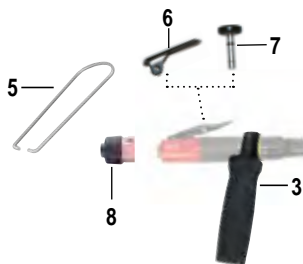

OPTIONAL ACCESSORIES

ITEM	DR300
3 Side handle for DR300	615 399 265 0
5 Suspension Bail	280893
6 Short lever	205 050 299 3
7 Kit inlet button	615 399 266 0
8 Kit silencer NPT	615 399 313 0
8 Kit silencer BSP	615 399 311 0
8 Kit Bumper	615 399 312 0

Controlled drilling



- Full range of solutions for composite drilling applications
- Avoid quality issues with thrust limitation device, which eliminates:
 - Composite delamination
 - Breakout burrs
 - Excessive wear on cutters
 - Operator dependence
- Easily adaptable to standard Desoutter pistol & straight drills
- Fully customizable (bushing, Vacuum...)
- Easy cutter change

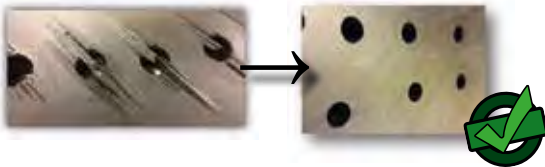

Adjustable thrust limitation force
Option: activation of thrust limitation only at exit point

Several stroke options, for different material stack thicknesses

Nylon Protective Tripod Feet
Protects drilling surface

Wide range of tools, shapes and speeds
Easy adaptation to Desoutter drill range

Rotating Tripod Foot
Ensures perpendicularity

Guided Drill Bushing
Ensures perfect Run-Out

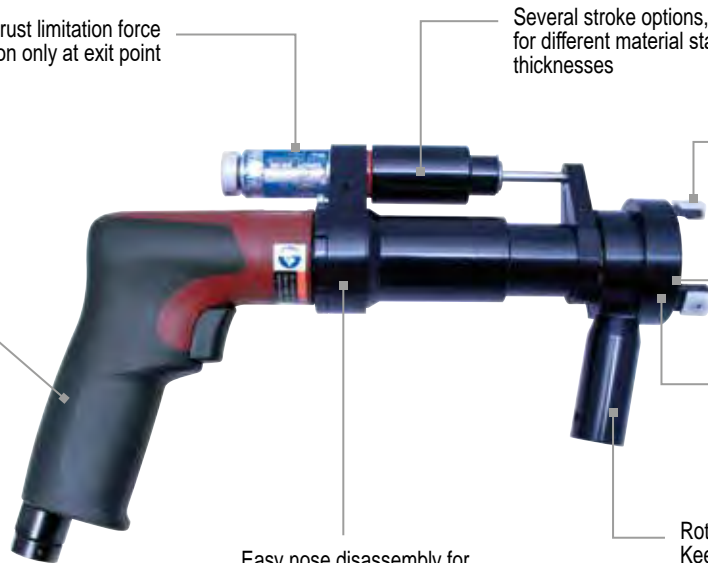

Easy nose disassembly for cutter replacement

Rotating Vacuum Shroud
Keeps working area clean and safe

How to order:

DR500-P18500 - STR25 – 4.5 NVT

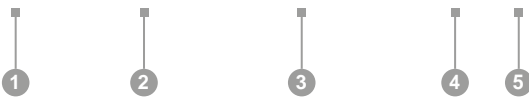

- 1 **Tool power & ergonomics**
Pistol tools: see page 206
DR350: 350W (0,5hp)
DR500: 500W (0,68hp)
Straight tools: see page 206
DR300: 300W (0,4hp)
DR450: 450W (0,6hp)

- 2 **Tool Speed**
- 3 **HCU Unit Stroke**
STR25: 25mm (1")
STR37 : 37mm (1.5")
* More strokes available on demand

- 4 **Cutter size**
Collets Series 200

DESCRIPTION	PART NO.
Collet Ø2.4 to 3.2mm	615 526 061 0
Collet Ø3.2 to 4mm	615 526 151 0
Collet Ø3.7 to 4.5mm	615 526 152 0
Collet Ø4.2 to 5mm	615 526 153 0
Collet Ø 5.2 to 6mm	615 526 062 0
Collet Ø7.2 to 8mm	615 526 064 0
Collet Ø 8.7 to 9.5mm	615 526 065 0
Collet Ø1/4" (Ø5.55 to 6.35mm)	615 526 063 0

- 5 **Nose type**
N: No tripod
V: Vacuum
T: Tripod

Tappers



A
T500 Series
 0.5kW (0.68hp) / 400 & 600 rpm



B
T450 Series
 0.5kW (0.68hp) / 400 & 600 rpm

PIC REF	MODEL	PART NUMBER	FREE SPEED	REVERSE SPEED	MOTOR POWER		MAX. TAPPING TORQUE		WEIGHT		LENGTH		AIR FLOW		AIR INLET
					rpm	rpm	kW	hp	STEEL	ALUMINIUM	kg	lb	mm	in.	l/s

TAPPERS

A	T500-P400	205 147 995 4	400	800	0.5	0.68	M10	M12	0.64	1.4	263	10.35	14	30	1/4
A	T500-P600	205 147 996 4	600	1200	0.5	0.86	M10	M12	0.64	1.4	263	10.35	14	30	1/4
B	T450-T400	615 176 181 0	400	800	0.5	0.68	M10	M12	0.64	1.4	263	10.35	14	30	1/4
B	T450-T600	615 176 182 0	600	1200	0.5	0.86	M10	M12	0.64	1.4	263	10.35	14	30	1/4

All models T500-P: Hose int. 10 mm (3/8")

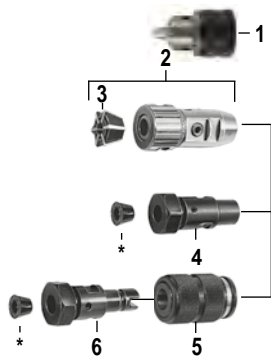

OPTIONAL ACCESSORIES

ITEM		PART NO.
1	Keyed chuck (1JT) - 0,8 to 10mm (3/8") (with key) T500-P400	29042
1	Keyed chuck (1JT) - 0,5 to 6,5mm (1/4") (with key) T500-P600	29492
	• Chuck key - T500-P400	29232
	• Chuck key - T500-P600	410213
2	Precision collet tap holder (including collet cap. M3 to M8)	29452
	• Collet capacity M3 to M7 (1/8" to 9/32")	29482
	• Collet capacity M4 to M8 (5/32" to 5/16")	29472
3	Collet capacity M6 to M12 (15/64" to 15/32")	97982
4	Tap Holder (1 JT)	69922
5	Quick Release Chuck (1 JT)	16852
6	Quick Release Tap Holder (1 JT)	69872

Collets for Tap Holders:

TAP SIZE		BA	SHANK DIA.	PART NO
mm	in.			
M2.2 & M2.5		6 & 8	2.8	2612
M3	1/8	5	3.2	2632
M3.5		4	3.6	2652
M4			4.0	2672
M4.5		3	4.5	2702
M5	3/16	2	5.0	2722
M5.5	7/32	1	5.6	2752
M6	1/4	0	6.3	2792
M7	9/32		7.1	2832
M8 & M11	5/1 & 7/16		8.0	2872
M9 & M12	1/2		9.0	69882
M10	3/8		10.0	69892
*Wrench for Tap Holder collet nut				29443
*2mm A/F hexagon key for Tap Holder grub screws				206773



A
2H16 Series
 Variable speed setting
 90 to 500 rpm - 47 to 240 Nm

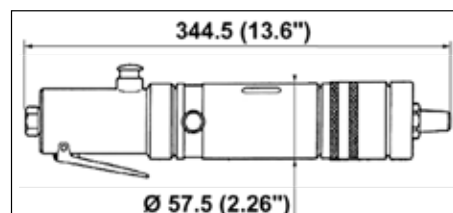

PIC REF	MODEL	PART NUMBER	LOW SPEED SETTING	HIGH SPEED SETTING	MAX. TAPPING TORQUE				WEIGHT		AIR FLOW		AIR INLET
					LOW SPEED	HIGH SPEED	Nm	ft.lb	Nm	ft.lb	kg	lb	l/s

TAPPERS

A	2H16-L-160/500-B18	1434264	160	500	140	103	47	34.7	3.1	6.8	15.6	33	3/8
A	2H16-L-90/250-B18	1434344	90	250	240	177	90	66.4	3.1	6.8	15.6	33	3/8

All models 2H16-L: Hose int. 10mm (3/8")

Deburring tools & Rivet Shaver



A

C27-LX-1450
1450 rpm
Collet size 6,4mm (1/4")



C

C27-LX300/400-T6-90 - BRB
300-400 rpm
Collet size 6,4mm (1/4")



E

RS450 Series
18500 rpm



B

C27-LX300-T6-45 - BRB
300 rpm
Collet size 6,4mm (1/4")



D

C27-LX300-QR - BRB
300 rpm
Collet size 6,4mm (1/4")



F

RS500 Series
18500 rpm



***BRB**
Button + Rear Bumper
available as well as accessory

PIC REF	MODEL	PART NUMBER	FREE SPEED rpm	COLLET SIZE mm	MAXIMUM CUTTER DIA.		WEIGHT		LENGTH		AIR FLOW		AIR INLET in.	HOSE INT. Ø	
					mm	in.	kg	lb	mm	in.	l/s	cfm		mm	in.
HOLE DEBURRING TOOLS															
A	C27-LX-1450	615 176 115 0	1450	6.4 (1/4")*	-	-	0.68	1.5	220.5	8.68	9.5	20	1/4	6	1/4
B	C27-LX300-T6-45 - BRB*	615 176 126 0	300	6.4 (1/4")*	-	-	0.82	1.81	291.5	11.48	8	17	1/4	6	1/4
C	C27-LX300-T6-90 - BRB*	615 176 128 0	300	6.4 (1/4")*	-	-	0.82	1.81	291.5	11.48	8	17	1/4	6	1/4
C	C27-LX400-T6-90 - BRB*	615 176 127 0	400	6.4 (1/4")*	-	-	0.82	1.81	291.5	11.48	8	17	1/4	6	1/4
D	C27-LX300-QR - BRB*	615 176 129 0	300	6.4 (1/4")*	-	-	0.58	1.27	187	7.36	8	17	1/4	6	1/4
RIVET SHAVER															
E	RS450-T-18500 (1/4"UNF)	615 176 184 0	18500	1/4"-28 UNF	14.3	9/16	1.2	2.64	216	8.5	14	30	1/4		
E	RS450-T-18500 (1/4"WHIT)	615 176 183 0	18500	1/4"-26 WHIT	14.3	9/16	1.2	2.64	216	8.5	14	30	1/4		
F	RS500-P18500 (1/4"UNF)	205 148 129 4	18500	1/4"-28 UNF	14.3	9/16	1.2	2.64	216	8.5	14	30	1/4	10	3/8
F	RS500-P18500 (1/4"WHIT)	205 148 130 4	18500	1/4"-26 WHIT	14.3	9/16	1.2	2.64	216	8.5	14	30	1/4	10	3/8

*: If speed adjustment is needed, you can do it with flow regulator PN LC121737

ACCESSORIES INCLUDED

ITEM	C27-LX	RS500
• ø 6.4mm (1/4") capacity collet	615 526 063 0	
1 Safety lever	205 050 288 3	
2 Cutter (90° point) – 10mm dia	91572	
3 Cutter – carbide tipped (11.1mm 7/16" dia)		70602
4 Cutter Guard		18822
• Wrench 19A/F	615 801 005 0	
• Collet Spindle Wrench	615 801 076 0	15533
• Cutter Guard Wrench		38873

OPTIONAL ACCESSORIES

ITEM	RS500
3 Cutter – carbide tipped ø6.4mm (ø1/4")	70572
3 Cutter – carbide tipped ø7.9mm (ø5/16")	70582
3 Cutter – carbide tipped ø9.5mm (ø3/8")	70592
3 Cutter – carbide tipped ø12.7mm (ø1/2")	70622
4 Cutter Guard ø6.4mm (ø1/4")	18782
4 Cutter Guard ø7.9mm (ø5/16")	18792
4 Cutter Guard ø9.5mm (ø3/8")	18802
4 Cutter Guard ø12.7mm (ø1/2")	18832
4 Cutter Guard ø14.3mm (ø9/16")	18842
5 Kit silencer NPT	615 399 313 0
5 Kit silencer BSP	615 399 311 0
5 Kit Bumper	615 399 312 0

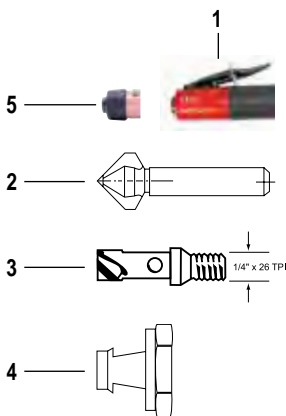

Rack Feed Drills

• The Rack Feed Drill is a semi-fixtured (nose mounted) portable drilling unit, utilising a manual feed through an integral "rack and pinion" mechanism to accommodate the approach drilling and retract cycles. This provides the user with complete control of the feed rate during drilling and allows the user to "feel" the feed rate required. Versatile and flexible, especially when drilling laminates and sandwich materials.

• RFD is suitable for drilling/reaming various materials used in the Aerospace industries e.g. Inconel, Titanium, Steel, Aluminium and Composites.



■ **RFD-100**
Speed range 60 to 2800 rpm
102mm (4") adjustable stroke
13mm (1/2") chuck capacity

■ **RFDT-125**
Speed range 60 to 800 rpm
127mm (5") adjustable stroke
No. 2 Morse taper spindle



For a Vacuum Kit option, please contact your local Desoutter representative

How to select your tool?

- 1** Select material
- 2** Select hole size
- 3** Select tool

RFD Selection

DRILL Ø	TOOL TYPE - RPM			
	Inconel	1 Titanium	Mild Steel	Aluminium
3mm - 1/8"	RFD(T)-330/500	RFD(T)-500	RFD-2800	RFD-2800
5mm - 3/16"	RFD(T)-140/330	RFD(T)-330/500	RFD-1850	RFD-2800
6mm - 1/4"	RFD(T)-140	RFD(T)-140/330	RFD(T)-800	RFD-1850
8mm - 5/16"	RFD(T)-140	RFD(T)-140/330	RFD(T)-800	RFD(T)-800
10mm - 3/8" 2	RFD(T)-85/140	RFD(T)-140 3	RFD(T)-800	RFD(T)-800
13mm - 1/2"	RFD(T)-60/85	RFD(T)-85/140	RFD(T)-500	RFD(T)-800
16mm - 5/8"		RFD(T)-85/140	RFD(T)-330	RFD(T)-800
19mm - 3/4"		RFD(T)-60/85	RFD(T)-85/140	RFD(T)-330/500
25mm - 1"			RFD(T)-60/85	RFD(T)-140/330

Use selection data as a guide only

MODEL	PART NUMBER	FREE SPEED	MAX STROKE		OUTPUT SPINDLE	CHUCK SPINDLE	LENGTH		WEIGHT		AIR FLOW		AIR INLET
			mm	in.			mm	in.	kg	lb	l/s	cfm	
RFD													
RFD-100-2800	681214	2800	102	4		1/2-20 UNF	652	25.67	3.9	8.6	11.8	25	1/4
RFD-100-1850	681394	1850	102	4		1/2-20 UNF	652	25.67	3.9	8.6	11.8	25	1/4
RFD-100-800	680084	800	102	4	Chuck	5/8-16 UNF	652	25.67	3.9	8.6	11.8	25	1/4
RFD-100-500	680164	500	102	4	13mm	5/8-16 UNF	652	25.67	3.9	8.6	11.8	25	1/4
RFD-100-330	680244	330	102	4	(1/2")	5/8-16 UNF	652	25.67	3.9	8.6	11.8	25	1/4
RFD-100-140	1457364	140	102	4	capacity	5/8-16 UNF	652	25.67	3.9	8.6	11.8	25	1/4
RFD-100-85	1457374	85	102	4		5/8-16 UNF	652	25.67	3.9	8.6	11.8	25	1/4
RFD-100-60	1457384	60	102	4		5/8-16 UNF	652	25.67	3.9	8.6	11.8	25	1/4
RFDT													
RFDT-125-800	1445654	800	127	5			764	30.08	5.5	12.1	11.8	25	1/4
RFDT-125-500	1445664	500	127	5	No. 2		764	30.08	5.5	12.1	11.8	25	1/4
RFDT-125-330	1445674	330	127	5	Morse		764	30.08	5.5	12.1	11.8	25	1/4
RFDT-125-140	1445504	140	127	5	Taper		764	30.08	5.5	12.1	11.8	25	1/4
RFDT-125-85	1445514	85	127	5			764	30.08	5.5	12.1	11.8	25	1/4
RFDT-125-60	1445524	60	127	5			764	30.08	5.5	12.1	11.8	25	1/4

All models: Hose int. 10 mm (3/8")

Accessories

ACCESSORIES INCLUDED

	PART NUMBER	
	RFD	RFDT
• Chuck with key capacity 13mm (5/8"x16)	29122	-
• Chuck with key capacity 13mm (1/2")	29142	-
• Extended Nose (1" x 14 LH nose thread)	251043	-
• Bayonet Plate – 45mm (1.77") centres	251063	-
• Bayonet Plate – 76mm (2.99") centres	-	35223

OPTIONAL ACCESSORIES

For more details on the following Part Numbers, please contact your local Desoutter representative

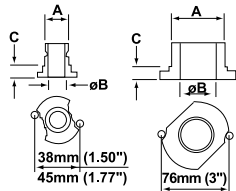

Bayonet Plates

	A	Ø B	C
Locating centres – 38mm (1.50")	3/4" x 16 (LH)	14.2mm (0.559")	9.5mm (3/8")
Locating centres – 45mm (1.77")	1" x 14 (LH)	19.05mm (3/4")	9.5mm (3/8")
Locating centres – 45mm (1.77")	11/8" x 20 (LH)	19.05mm (3/4")	9.5mm (3/8")
Locating centres – 76mm (2.99")	23/32" x 16 (LH)	38.1mm (1.150")	12.7mm (1/2")

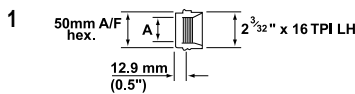

Nose Attachments

NOSE TYPE	TO SUIT BAYONET PLATE CENTRES	THREAD 'A'
1	38mm (1.50")	3/4" x 16 (LH)
2	38mm (1.50")	3/4" x 16 (LH)
2	45mm (1.77")	1" x 14 (LH)
3	-	1-1/4" x 12 (LH)
3	-	1-1/4" x 12 (LH)
3	-	2" x 16 (LH)

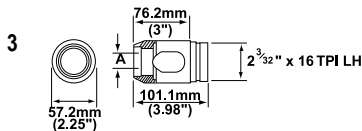
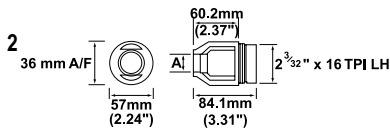

Extension Tubes

NOMINAL STROKE AVAILABLE TO DRILL	LENGTH 'A'
• 80mm (3.15")	170mm (6.69")

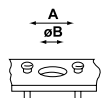
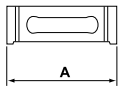

Jig Plates

CENTRE "A"
38mm (1.50")
45mm (1.77")

Drill bushes

ATTACHMENT	"Ø B"
ø 14.2mm	Ø 10 to 14mm
ø 19.05mm	Ø 10 to 18mm
ø 38.01mm	Ø 22 to 35mm

For dimension 'ØB' please ask for details of our range of drill bushes

Compression Tools



SQUEEZERS

- Wide range of Alligator Jaws & C-Yokes tools.
- Excellent power-to-weight ratio.
- Fast and slow approach.
- Robust and reliable design.

How to select the right tool?



1
Rivet

Material
Diameter



2
Application

Accessibility
Customer specification



3
Select tool

Power required (p.189)
C-Yoke or Alligator
Gap & Reach figures



4
Select Rivet set & shims

Rivet set shank
Rivet set type
Rivet set length

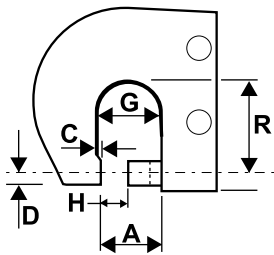

Jaw and Yoke Terminology:
(rivet sets are not in place in this illustration)

- A Throat gap
- C Anvil work clearance
- D Lower offset
- G Total yoke gap
- H Closed height
- R Reach

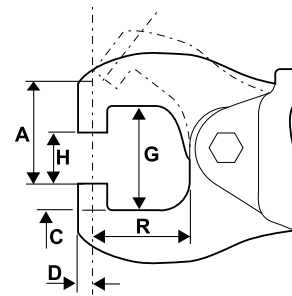

C YOKE MODEL	A		C		D		G		H		R		
	mm	in.	mm	in.	mm	in.	mm	in.	mm	in.	mm	in.	
CP0214CELEL	32	1-1/4	-	-	5	3/16	32	1-1/4	17.5	11/16	38	1-1/2	
CP0214FALEL	32	1-1/4	-	-	5	3/16	32	1-1/4	17.5	11/16	38	1-1/2	
CP0214SETEL	32	1-1/4	-	-	6.4	1/4	32	1-1/4	17.5	11/16	38	1-1/2	
CP0214KETEL	32	1-1/4	-	-	6.4	1/4	32	1-1/4	17.5	11/16	38	1-1/2	
CP0351CUDEL	39	1-17/32	-	-	5.5	7/32	29	1-5/32	20	25/32	54	2-1/8	
CP0351FUDEL	39	1-17/32	-	-	5.5	7/32	29	1-5/32	20	25/32	54	2-1/8	
CP0341CUDEL	57	2-1/4	3	1/8	9	11/32	70	2-3/4	25	1	54	2-1/8	
CP0214FAXEL	44	1-3/4	-	-	5	3/16	44	1-3/4	17.5	11/16	50.8	2.5	
CP0214FAREL-5	36	1,417	-	-	8	0,313	36	1,417	17/20	0,669	10,787	50	1,969
CP0214 CEREL-5	36	1,417	-	-	8	0,313	36	1,417	17/20	0,669	10,787	50	1,969

ALLIGATOR MODEL	A		D		G		H		R	
	mm	in.	mm	in.	mm	in.	mm	in.	mm	in.
CP0214ANGEL	54	2-1/8	5.5	7/32	54	2-1/8	22	7/8	76	3
CP0214ENGEL	54	2-1/8	5.5	7/32	54	2-1/8	22	7/8	76	3
CP0214ANFEL	48	1-7/8	5.5	7/32	54	2-1/8	22	7/8	57	2-1/4
CP0214ANFEL	48	1-7/8	5.5	7/32	54	2-1/8	22	7/8	57	2-1/4
CP0214ENCCEL-5	48	1-7/8	5.5	7/32	54	2-1/8	22	7/8	57	2-1/4
CP0214ANBEL	38	1-1/2	5.5	7/32	41	1-5/8	22	7/8	38	1-1/2
CP0214ENBEL	38	1-1/2	5.5	7/32	41	1-5/8	22	7/8	38	1-1/2
CP0351ANFEL	62	2-7/16	5.5	7/32	56	2-3/16	19	3/4	232	9-1/8
CP0351ESVEL	62	2-7/16	5.5	7/32	56	2-3/16	19	3/4	232	9-1/8
CP0351ESREL	81	3-3/16	5.5	7/32	51	2	38	1-1/2	178	7
CP0351ASKEL	57	2-1/4	5.5	7/32	41	1-5/8	22	7/8	127	5
CP0351ESKEL	57	2-1/4	5.5	7/32	41	1-5/8	22	7/8	127	5
CP0351ASGEL	38	1-1/2	5.5	7/32	41	1-5/8	22	7/8	73	2-7/8
CP0351ESGEL	38	1-1/2	5.5	7/32	41	1-5/8	22	7/8	73	2-7/8

Riveting Compression Tools

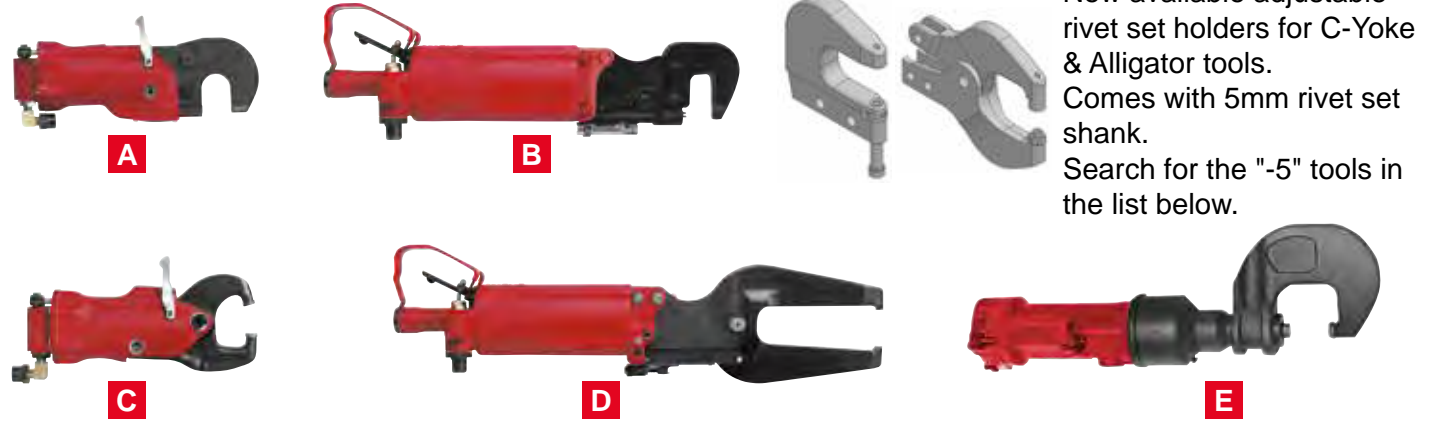

CP0214

CP0351

CP0341 - Pneumatic TM → Full power through the full stroke

PIC REF	MODEL	PART NUMBER	CAPACITY				MAX FORCE		MOVING PLUNGER				STANDARD YOKE DIMENSIONS				LENGTH		WEIGHT	
			LIGHT		HARD		(90 PSI/ 6.2 BAR)		MAX TRAVEL		FINAL PART OF STROKE AT MAX. FORCE		REACH R		CLOSED HEIGHT H		mm	in.	kg	lb
			mm	in.	mm	in.	kN	lb	mm	in.	mm	in.	mm	in.	mm	in.	mm	in.	kg	lb

C-YOKE (single cylinder)

A	CP0214CELEL*	T012344	3.2	1/8	2.4	3/32	13.35	3,000	14.3	9/16	1.3	0.050	38.1	1-1/2	17.5	11/16	262	10.3	2.0	4.41
A	CP0214CEREL-5	6151710160	3.2	1/8	2.4	3/32	13.35	3,000	14.3	9/16	1.3	0.050	50	1,969	17/20	0,669/0,787	262	10.3	2.0	4.41
	CP0214CENEL	T018677	Same power unit as above without yoke																	
B	CP0351CUDEL*	T008955	4.8	3/16	4.0	5/32	26.70	6,000	14.3	9/16	3.2	0.125	54	2-1/8	19.8	25/32	445	17.5	5.7	12.6
	CP0351CUNEL	T007772	Same power unit as above without yoke																	

C-YOKE (tandem cylinder)

A	CP0214FALEL*	T013152	4.8	3/16	4.0	5/32	26.70	6,000	14.3	9/16	1.6	0.063	38.1	1-1/2	17.5	11/16	356	14	2.5	5.5
A	CP0214FAREL-5	6151710150	4.8	3/16	4.0	5/32	26.70	6,000	14.3	9/16	1.6	0.063	50	1,969	17/20	0,669/0,787	356	14	2.5	5.5
A	CP0214FAXEL*	T022528	4.8	3/16	4.0	5/32	26.70	6,000	14.3	9/16	1.6	0.063	50.8	2.5	17.5	11/16	366	14.4	2.6	5.7
	CP0214FANEL	T018430	Same power unit as above without yoke																	
A	CP0214KETEL**	T023475	4.8	3/16	4.0	5/32	26.70	6,000	14.3	9/16	1.6	0.063	38.1	1-1/2	17.5	11/16	356	14	2.5	5.5
B	CP0351FUDEL*	T012608	6.4	1/4	5.6	7/32	53.40	12,000	14.3	9/16	3.2	0.125	54	2-1/8	19.8	25/32	552	21.7	6.9	15.2

ALLIGATOR (single cylinder)

C	CP0214ANBEL*	T012343	3.2	1/8	2.4	3/32	13.35	3,000	15.9	5/8	1.3	0.050	38.1	1-1/2	22.2	7/8	233	9.17	1.7	3.75
C	CP0214ANFEL*	T018671	2.4	3/32	2.4	3/32	9.79	2,200	22.2	7/8	2.4	0.094	57.1	2-1/4	22.2	7/8	254	10	1.9	4.18
C	CP0214ANGEL*	T018672	2.4	3/32	1.6	1/16	8.01	1,800	31.8	1-1/4	1.4	0.056	76.2	3	22.2	7/8	273	10.7	2.0	4.41
	CP0214ANPEL	T019138	Same power unit as above without yoke																	
D	CP0351ASGEL*	T007783	4.0	5/32	3.2	1/8	23.14	5,200	15.9	5/8	3.2	0.125	73	2-7/8	22.2	7/8	495	19.5	7.1	15.6
D	CP0351ASKEL*	T007773	3.2	1/8	2.4	3/32	15.13	3,400	34.0	1-3/8	4.8	0.188	127	5	22.2	7/8	549	21.6	9.0	19.8
D	CP0351ASVEL*	T009582	3.2	1/8	2.4	3/32	13.35	3,000	42.9	1-11/16	1.6	0.063	232	9-1/8	19.1	3/4	654	25.7	11.9	26.2

ALLIGATOR (tandem cylinder)

C	CP0214ENGEL*	T018164	3.2	1/8	2.4	3/32	15.13	3,400	31.8	1-1/4	2.6	0.104	76.2	3	22.2	7/8	343	13.5	2.5	5.51
C	CP0214ENFEL*	T018163	4.0	5/32	3.2	1/8	19.14	4,300	22.2	7/8	2.4	0.094	57.1	2-1/4	22.2	7/8	324	12.8	2.4	5.28
C	CP0214ENCCEL-5	6151710170	4.0	5/32	3.2	1/8	19.14	4,300	22.2	7/8	2.4	0.094	57.1	2-1/4	17.2/22.2	0.68/0.87	324	12.8	2.4	5.28
C	CP0214ENBEL*	T018678	4.8	3/16	4.0	5/32	26.70	6,000	15.9	5/8	1.6	0.063	38.1	1-1/2	22.2	7/8	303	11.9	2.2	4.85
D	CP0351ESKEL*	T012603	4.8	3/16	4.0	5/32	30.26	6,800	34.0	1-3/8	4.8	0.188	127	5	22.2	7/8	657	25.9	10.2	22.5
D	CP0351ESREL*	T012604	4.8	3/16	4.0	5/32	26.70	6,000	42.9	1-11/16	4.8	0.188	178	7	38.1	1-1/2	708	27.9	12.2	26.9
D	CP0351ESVEL*	T012605	4.8	3/16	4.0	5/32	26.70	6,000	42.9	1-11/16	1.6	0.063	232	9-1/8	19.1	3/4	762	30	13.2	29.1
D	CP0351ESGEL*	T012602	6.4	1/4	4.8	3/16	46.28	10,400	15.9	5/8	3.2	0.125	73	2-7/8	22.2	7/8	603	23.7	8.4	18.5

C-YOKE (pneumatic™)

E	CP0341CUDEL**	T022512	7.1	9/32	6.4	1/4	60.1	13,500	31.8	1-1/4	Full stroke								
	CP0341CUNEL	T022493	Same power unit as above without yoke																

* CR1 / ** CR2 // -5 = 5mm rivet set shank

Compression Tools - Riveting

Rivet set shank (CR1/CR2)

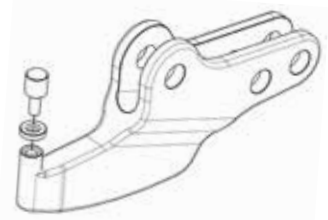

SHANK DIMENSIONS FOR RIVET SETS

For CP0214, CP0351 and CP0341 Compression Riveters

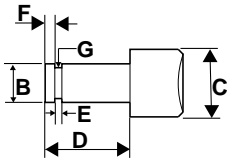

TYPE OF RIVET SET SHANK	B		C*		D		E		F		G	
	mm	in.	mm	in.	mm	in.	mm	in.	mm	in.	mm	in.
CR-1 (ø 4.8mm 3/16")	4.75-4.72	0.187-0.186	12.7	1/2	12.7	1/2	3.45-3.38	0.136-0.133	1.6	1/16	3.23-3.12	0.127-0.123
CR-2 (ø 6.4mm 1/4")	6.42-6.40	0.249-0.248	15.9	5/8	15.9	5/8	3.45-3.38	0.136-0.133	2.4	3/32	4.80-4.70	0.189-0.185

* 'C' dimension is for flush set only. 'C' varies on cupped sets according to rivet size and type of head.

Adjustable Rivet set shank 5mm

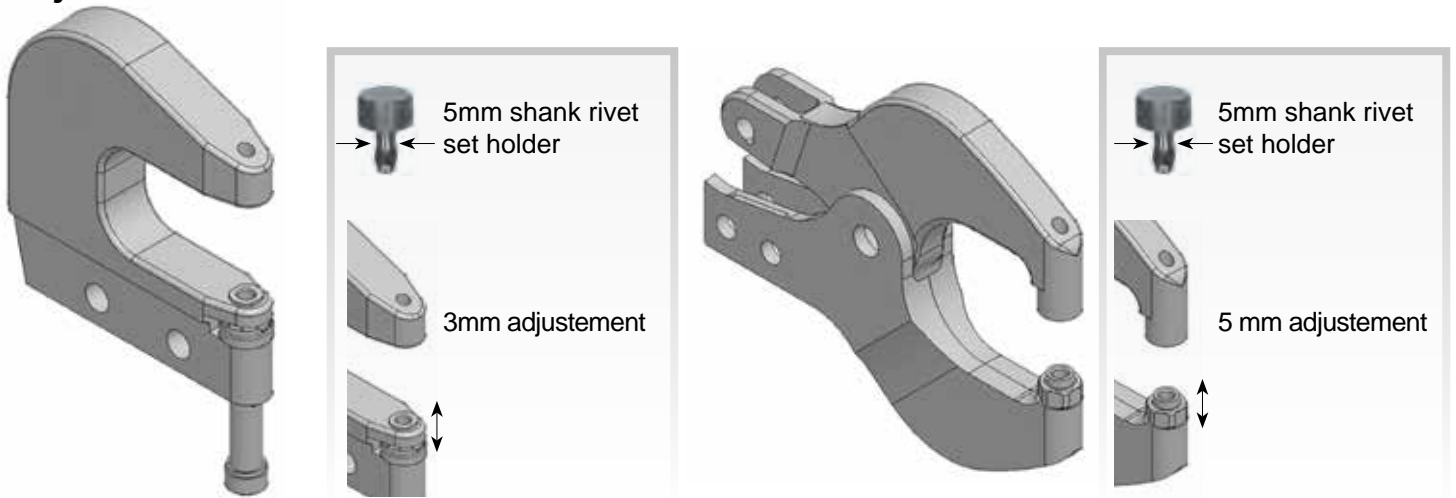

Rivet set length calculation

To develop maximum power, the riveter must drive (set) the rivet at the end of the riveter's stroke
For maximum power the combined length of the two rivet sets must be of the correct length

$$A1 + A2 = H - M - Z$$

A1: Rivet set thickness (mobile jaw)

A2: Rivet set thickness (fix jaw)

H= Opening at the end of the riveting

M= Total thickness of material to be assembled

Z= height of finished rivet head (flush)

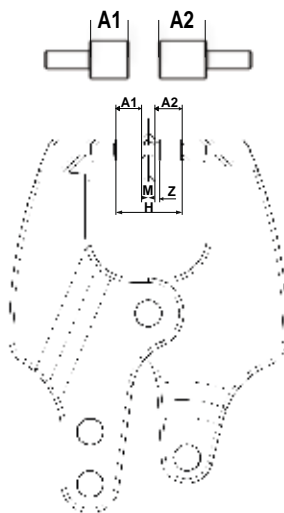

Two Flushed rivet sets

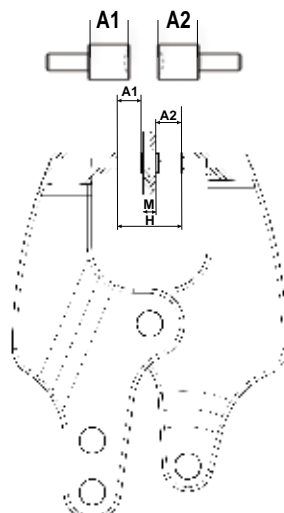

Two cupped rivet sets
Z = 0

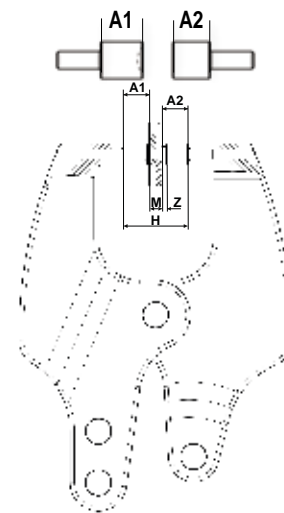

1 flushed rivet + cupped rivet set

Compression Tools - Rivet sets

Rivet set Selection

SET LENGTH SPACER SHIMS

TYPE OF RIVET SET SHANK	PART NUMBER OF HARDENED SHIMS	
CR-1	0.4mm (1/64") P083254	0.8mm (1/32") P083255

**RIVET SET
* SHIM**

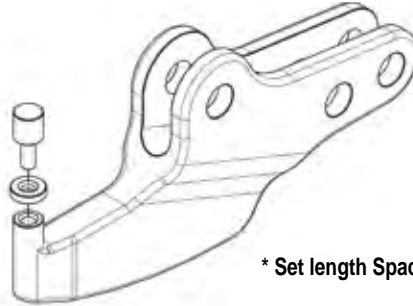

* Set length Spacer Shims



Riveting Hammers



- Wide range of hammers suitable for all applications.
- Recoilless series for better operator's comfort.
- Progressive trigger for better control.

How to select the right tool?

<p>1 Rivet Light/Hard Material Diameter</p>	<p>2 Application accessibility</p>	<p>3 Operation repetitiveness Low vibration level</p>	<p>4 Rivet set selection</p>

Tool range

Our range covers a wide range of applications to answer all your requirements



Riveting Hammers

Selection guide



A

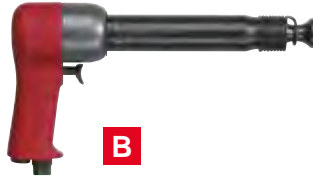

B



C



D



E

PIC REF	MODEL	PART NUMBER	AIR FRAME REF	BLOW PER MINUTE	BORE & STROKE		ENERGY PER BLOW		CHISEL SHANK		RIVET CAPACITY		WEIGHT		AIR INLET	HOSE INT. Ø	
					mm (in.)	J	ft.lb	mm	in.	mm (in.)	mm (in.)	kg	lb	in.	mm	in.	

Standard

A	CP4444-RURAB	T022961	2X	2580	12.7 x 50.8	4.0	2.9	10.2	0.401	3.2	2.4	1.0	2.2	1/4	10	3/8
			(200)		(1/2 x 2)					(1/8)	(3/32)					
A	CP4444-RUSAB	T022962	3X	2160	12.7 x 76.2	6.1	4.5	10.2	0.401	4.8	4.0	1.1	2.3	1/4	10	3/8
			(300)		(1/2 x 3)					(3/16)	(5/32)					
A	CP4444-RUTAB	T022963	4X	1740	12.7 x 101.6	8.1	6.0	10.2	0.401	6.4	4.8	1.3	2.7	1/4	10	3/8
			(240)		(1/2 x 4)					(1/4)	(3/16)					
B	CP4447-RUSAB	T022965	5XB	1560	19.1 x 68.3	12.3	9.1	12.7	0.498	6.4	4.8	2.2	4.7	1/4	10	3/8
			500		(3/4 x 2-11/18)					(1/4)	(3/16)					
B	CP4447-RUTAB	T022912	7XB	1140	19.1 x 98.4	17.8	13.1	12.7	0.498	7.9	6.4	2.3	5.1	1/4	10	3/8
			(700)		(3/4 x 3-7/8)					(5/16)	(1/4)					
B	CP4447-RUVAB	T022964	9XB	900	19.1 x 147.6	26.6	19.6	12.7	0.498	9.5	7.9	2.7	9.0	1/4	10	3/8
			(800)		(3/4 x 5-13/16)					(3/8)	(5/16)					

Vibration reduced

C	CP4450-2	T025189	2X	2580	12.7 x 50.8	4.0	2.9	10.2	0.401	3.2	2.4	1.2	2.7	1/4	10	3/8
			(200)		(1/2 x 2)					(1/8)	(3/32)					
C	CP4450-3	T025190	3X	2160	12.7 x 76.2	6.1	4.5	10.2	0.401	4.8	4.0	1.3	2.8	1/4	10	3/8
			(300)		(1/2 x 3)					(3/16)	(5/32)					
C	CP4450-4	T025191	4X	1740	12.7 x 101.6	8.1	6.0	10.2	0.401	6.4	4.8	1.5	3.2	1/4	10	3/8
			(400)		(1/2 x 4)					(1/4)	(3/16)					
D	CP4475-3	T025241	5XB	2000	19.1 x 76.2	13.7	10.1	12.7	0.498	6.4	4.8	1.8	3.9	1/4	10	3/8
			(500)		(3/4 x 3)					(1/4)	(3/16")					
D	CP4475-4	T025242	7XB	1700	19.1 x 101.6	18.3	13.5	12.7	0.498	7.9	6.4	2.4	5.3	1/4	10	3/8
			(700)		(3/4 x 4)					(5/16)	(1/4)					
D	CP4475-6	T025243	9XB	1250	19.1 x 152.4	27.5	20.3	12.7	0.498	9.5	7.9	2.8	6.2	1/4	10	3/8
			(800)		(3/4 x 6)					(3/8)	(5/16)					
E	CP4450-S-2	205 146 712 4	2X	2580	12.7 x 50.8	4.0	2.9	10.2	0.401	3.2	2.4	1.25	2.8	1/4	10	3/8
					(1/2 x 2)					(1/8)	(3/32)					
E	CP4450-S-3	205 146 713 4	3X	2160	12.7 x 76.2	6.1	4.5	10.2	0.401	4.8	4.0	1.35	3.0	1/4	10	3/8
					(1/2 x 3)					(3/16)	(5/32)					
E	CP4450-S-4	205 146 714 4	4X	1740	12.7 x 101.6	8.1	6.0	10.2	0.401	6.4	4.8	1.45	3.2	1/4	10	3/8
					(1/2 x 4)					(1/4)	(3/16)					

* LIGHT: Aluminium 2017 / 2117 (DCJ-DXJ / D-AD)

** HARD: Aluminium 7050 (DKJ / KE / E) (M) (T)

Dimensions

Model	A	
	mm	in.
CP4444-RURAB	170	6.7
CP4444-RUSAB	186	7.3
CP4444-RUTAB	211	8.3
CP4447-RUSAB	227	8.9
CP4447-RUTAB	252	9.9
CP4447-RUVAB	303	11.9

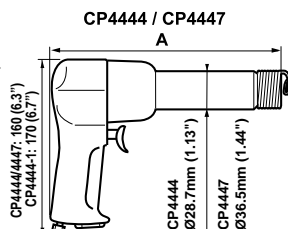

Model	A		B		C		D	
	mm	in.	mm	in.	mm	in.	mm	in.
CP4450-2	213	8.4	32	1.26	102	4.0	138	5.4
CP4450-3	226	8.9	32	1.26	102	4.0	138	5.4
CP4450-4	251	9.9	60	2.36	102	4.0	138	5.4
CP4475-3	275	10.8	54	2.13	180	7.1	140	5.5
CP4475-4	300	11.8	79	3.11	180	7.1	140	5.5
CP4475-6	351	13.8	130	5.12	180	7.1	140	5.5

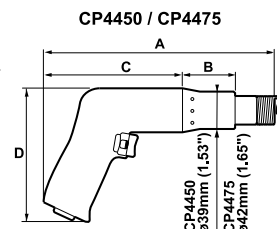

Accessories

CP4444 / CP4447 / CP4450 / CP4475

ACCESSORIES INCLUDED

	PART NUMBER		
	CP4444-1	CP4444 CP4450	CP4447 CP4475
• Light wire quick change retainer	205 053 564 3	A046095	-
• Wire quick change retainer	-	-	A047095

OPTIONAL ACCESSORIES

ITEM	CP4444	CP4447
	CP4450	CP4475
1 Zip-Quick retainer	A046094	-
2 Beehive retainer	A046096	A047096
3 Beehive retainer	-	A046096
4 Nail driving attachment for 20-60 penny nail size (for CP4447-RUSAB & CP4475)	-	P042448

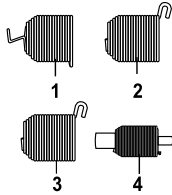

CP4444 / CP4450

TYPE I FLUSH RIVET SETS Ø 10.2MM (.401")

	ØA MM (IN.)	CP4444/4450 Ø10.2 (0.401") SHANK
•	25.4 (1)	A046090
•	44.5 (1-3/4)	A046091

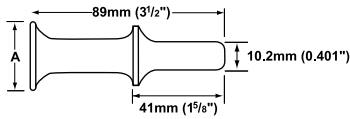

CP4447 / CP4475

TYPE I FLUSH RIVET SETS Ø 12.7MM (.498")

	ØA MM (IN.)	SHANK Ø12.7MM (0.498")
•	31.8 (1-1/4)	A047091

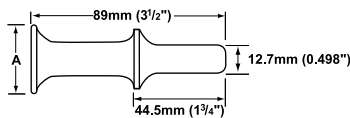



Removal Tools - Selection Guide

TOOL TYPE	ACCESSORIES	PAGE
<p>GRINDERS: for carbide burrs, mounted points & sanding discs</p> 		<p>250-257</p>
<p>ROUTERS</p> 		<p>258</p>
<p>COLLET GRINDER ACCESSORIES</p>		<p>259</p>
<p>GRINDERS: for cone wheels, type 1 wheels, depressed center wheels, cut-off wheels, diamond discs, flap wheels</p> 		<p>260-275</p>
<p>SANDERS: for expandable wheels, flap wheels, brushes, abrasive discs</p> 		<p>276-285</p>
<p>DUST EXTRACTION SYSTEMS: for straight and angle grinders for angle and vertical sanders</p> 		<p>286-293</p>
<p>RANDOM ORBITAL SANDERS AND POLISHERS: for abrasive discs and polishing accessories ORBITAL SANDERS: for abrasive sheets</p> 		<p>294-305</p>
<p>BELT SANDERS</p> 		<p>306-307</p>

Accessories

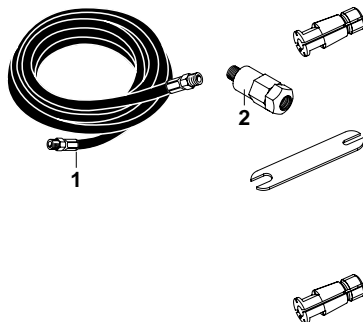
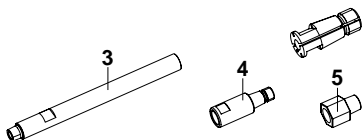
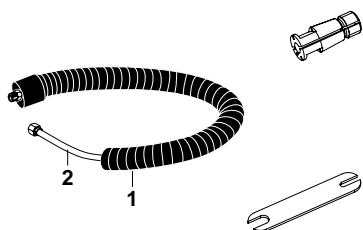
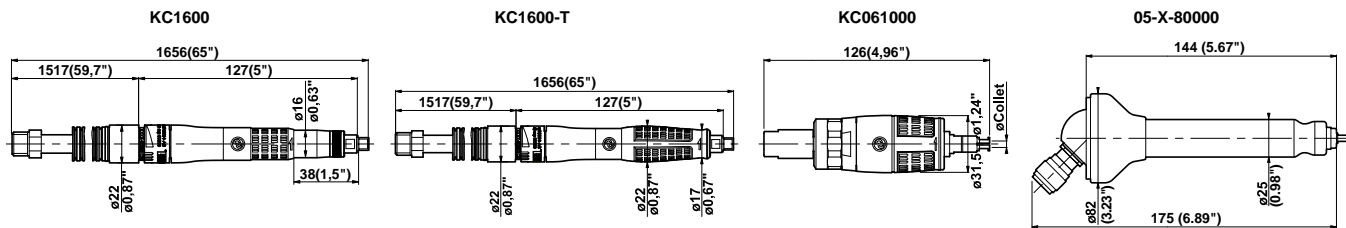

KC1600-T / KC1600

ACCESSORIES INCLUDED

ITEM	PART NO.
• Collet ø 3 mm	205 047 961 3
1 Exhaust kit - L = 1m (39.4")	615 396 405 0
2 Mounted inlet hose 1/4" BSP - ø 6mm (1/4") - L = 1.5m (59")	615 875 119 0
• Spanner (Qty 2)	205 047 965 3
• Carrying case (for T version only)	P137979

OPTIONAL ACCESSORIES

ITEM	PART NO.
• Collet ø 2.38 mm (3/32")	205 048 059 3
3 Machine extension - L = 150mm (5.9")	615 595 330 0
4 Collet extension - L = 20mm (0.79")	615 595 329 0
5 Adaptor 1/4" BSP - 1/4" NPT female	181523

KC061000 / 05-X-80000

ACCESSORIES INCLUDED

ITEM	KC061000	05-X-80000
• Collet ø 3 mm	205 047 961 3	9812
1 Complete inlet hose 1/8"M - 1/4"M, ø 5mm (3/16") L = 2.40m (94.5")	P043886	
2 Filter 1/4" F-1/4"M. NPT	P056381	
• Spanner (Qty 2)	205 047 965 3	

OPTIONAL ACCESSORIES

	KC061000	05-X-80000
• Collet ø 2.38mm (3/32")	205 048 059 3	9792
1 Complete inlet hose 1/4"M - 1/8"M-BSP, ø 5mm (3/16") L = 3m (118")		75922



Grinders for carbide burrs and mounted points

44 to 100 Watts (0.06 to 0.13 hp) - 60000 to 100000 rpm



A



B



C



D

Caution: comply with the speeds recommended by component and abrasive manufacturers.

PIC REF	MODEL	PART NUMBER	FREE SPEED	COLLET MAX CAPACITY		POWER		WEIGHT		AIR CONSUMPTION		AIR INLET. THREAD	HOSE INT. Ø		
				mm	in.	W	hp	kg	lb.	l/s	cfm	in.	mm	in.	
			rpm												
A	KC1600-T	615 170 313 0	60000	3.00		100	0.13	0.15	0.33	4.9	10.4	1/4 BSP	6	1/4	
B	KC1600	615 170 315 0	60000	3.00		100	0.13	0.15	0.33	4.9	10.4	1/4 BSP	6	1/4	
Turbine grinders															
C	KC061000	205 146 638 4	100000	3.00		44	0.06	0.24	0.53	8.5	18.0	1/4	5	3/16	
D	05-X-80000	258984	80000	3.17	1/8	75	0.1	0.30	0.66	2.8	5.9	1/8	5	3/16	

Accessories

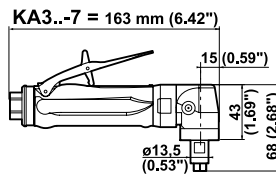
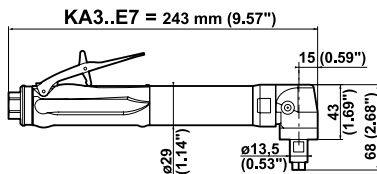
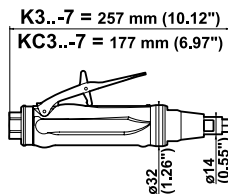

K3..-7 / KC3..-7 / KA3..E7 / KA3..-7 / KA3.135-7

ACCESSORIES INCLUDED

	K3.. / KC3.. / KA3..	KA3.135
• CNOMO collet \varnothing 6 mm	615 526 046 0	615 526 079 0
• Exhaust hose L = 0.8m (31")	615 875 106 0	
• 1/4" air hose nipple for 8mm (5/16") ID hose	615 704 019 0	
• 1/4" air hose nipple for 6mm (1/4") ID hose		615 705 009 0
• Flat wrench, 10mm (25/64")	615 801 002 0	615 801 002 0
• Flat wrench, 11mm (7/16")	615 801 003 0	
• Flat wrench, 14mm		615 801 005 0

OPTIONAL ACCESSORIES

ITEM	A		B	
	K3.. / KC3.. / KA3..		KA3.135	
• Collet \varnothing 2 mm			615 526 066 0	
• CNOMO collet \varnothing 2.5 mm	615 526 089 0		615 526 068 0	
• CNOMO collet \varnothing 3 mm	615 526 044 0		615 526 069 0	
• CNOMO collet \varnothing 3.2 mm (1/8")	615 526 045 0			
• Collet \varnothing 3.5mm			615 526 070 0	
• CNOMO collet \varnothing 4 mm (5/32")	615 526 090 0		615 526 071 0	
• CNOMO collet \varnothing 4.5 mm			615 526 073 0	
• CNOMO collet \varnothing 5 mm	615 526 092 0		615 526 075 0	
• Collet \varnothing 5.5mm			615 526 077 0	
• CNOMO collet \varnothing 6.4 mm (1/4")	615 526 047 0			
• Collet \varnothing 6.5mm			615 526 081 0	
• Collet \varnothing 7mm			615 526 083 0	
• Collet \varnothing 7.5mm			615 526 084 0	
• Collet \varnothing 8mm (5/16")			615 526 088 0	
1 Complete silencer kit	615 396 101 0		615 399 423 0	
2 Silencer	615 574 028 0			
3 Clippable silencer	615 396 124 0			
4 Exhaust hose L = 0.8m (31")			615 875 106 0	
5 Backing pad \varnothing 50mm			615 804 098 0	
6 Grease gun (capacity 24g - 0.8 oz.)	615 990 149 0			
• Grease for bevel gear (1kg - 2.2lb)	615 990 148 0			

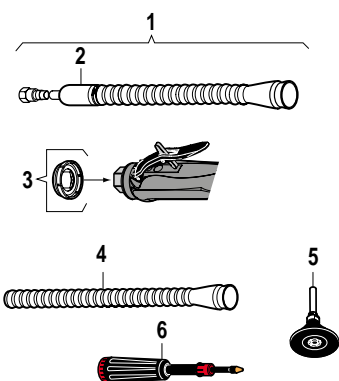
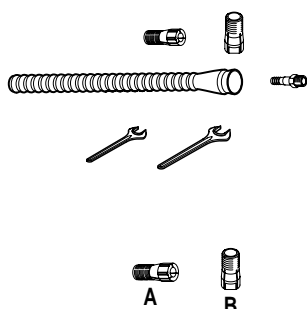

Grinders for carbide burrs, mounted points and sanding discs

300 and 375 Watts (0.4 and 0.5 hp) - 12000 to 40000 rpm

Supplied with CNOMO collet, ø 6mm



A



B



C



D



E

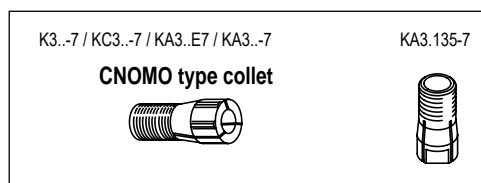

Caution: comply with the speeds recommended by component and abrasive manufacturers. PIC

PIC REF	MODEL	PART NUMBER	FREE SPEED rpm	COLLET MAX CAPACITY		POWER		WEIGHT		AIR CONSUMPTION				AIR INLET. THREAD		HOSE INT. Ø	
				mm	in.	W	hp	kg	lb.	AT FREE SPEED		AT MAX OUTPUT		in.	mm	in.	

STRAIGHT GRINDERS

A	K340-7	615 170 036 0	40000	6.4	1/4	375	0.5	0.58	1.28	7.5	16.0	10.0	21	1/4	8	5/16
A	K331-7	615 170 035 0	31000	6.4	1/4	375	0.5	0.58	1.28	4.5	9.5	9.5	20	1/4	8	5/16
A	K325-7	615 170 034 0	25000	6.4	1/4	375	0.5	0.58	1.28	3.5	7.5	9.5	20	1/4	8	5/16
A	K320-7	615 170 033 0	20000	6.4	1/4	375	0.5	0.58	1.28	2.5	5.0	8.0	17	1/4	8	5/16
B	KC340-7	615 170 032 0	40000	6.4	1/4	375	0.5	0.40	0.88	7.5	16.0	10.0	21	1/4	8	5/16
B	KC331-7	615 170 031 0	31000	6.4	1/4	375	0.5	0.40	0.88	4.5	9.5	9.5	20	1/4	8	5/16
B	KC325-7	615 170 030 0	25000	6.4	1/4	375	0.5	0.40	0.88	3.5	7.5	9.5	20	1/4	8	5/16
B	KC320-7	615 170 029 0	20000	6.4	1/4	375	0.5	0.40	0.88	2.5	5.0	8.0	17	1/4	8	5/16

ANGLE GRINDERS

C	KA320E7	615 170 047 0	20000	6.4	1/4	375	0.5	0.60	1.32	6.5	13.5	10.0	21	1/4	8	5/16
C	KA312E7	615 170 039 0	12000	6.4	1/4	375	0.5	0.60	1.32	3.0	6.5	9.0	19	1/4	8	5/16
D	KA320-7	615 170 043 0	20000	6.4	1/4	375	0.5	0.50	1.10	6.5	13.5	10.0	21	1/4	8	5/16
D	KA312-7	615 170 037 0	12000	6.4	1/4	375	0.5	0.50	1.10	3.0	6.5	9.0	19	1/4	8	5/16
E	KA3.135-7	615 170 522 0	13500	8.0	5/16	300	0.4	0.60	1.32	9.5	20.0	-	-	1/4	6	1/4

Accessories

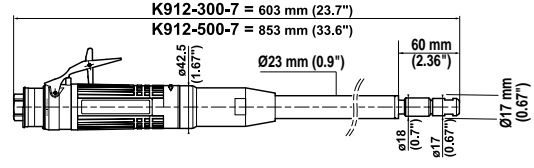
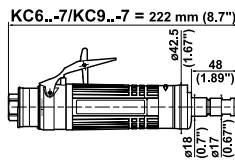
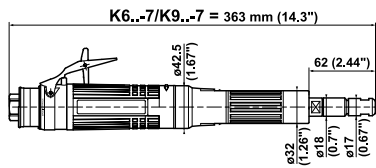

K6..-7 / K9..-7 / KC6..-7 / KC9..-7

ACCESSORIES INCLUDED

	PART NO.
• Collet-holder	615 523 018 0
• CNOMO collet \varnothing 6mm	615 526 049 0
• Exhaust hose L = 1.5m (60")	615 875 113 0
• Clamp	615 873 415 0
• 3/8" air hose nipple for 10mm (3/8") ID hose	615 704 017 0
• Flat wrench, 14mm (Qty 2)	615 801 005 0

OPTIONAL ACCESSORIES

ITEM	PART NO.
• Collet-holder extension L = 28mm (1.1")	615 523 019 0
• CNOMO collet \varnothing 3 mm	615 526 048 0
• CNOMO collet \varnothing 6.35 mm (1/4")	615 526 050 0
• CNOMO collet \varnothing 8 mm	615 526 051 0
1 Complete silencer kit	615 396 166 0
2 Clamp	615 873 115 0
3 Reinforced cloth-lined exhaust hose L = 0.75m (30")	615 875 116 0
4 Clippable silencer	615 396 655 0

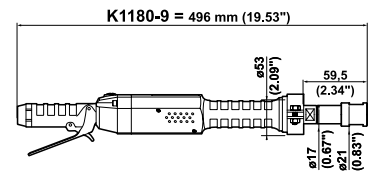
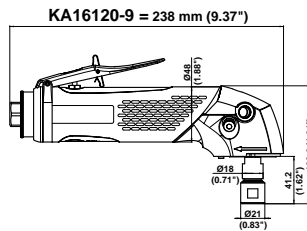
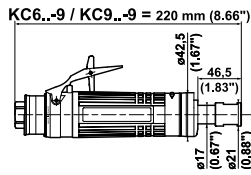
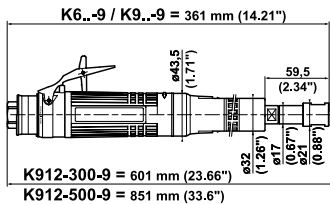
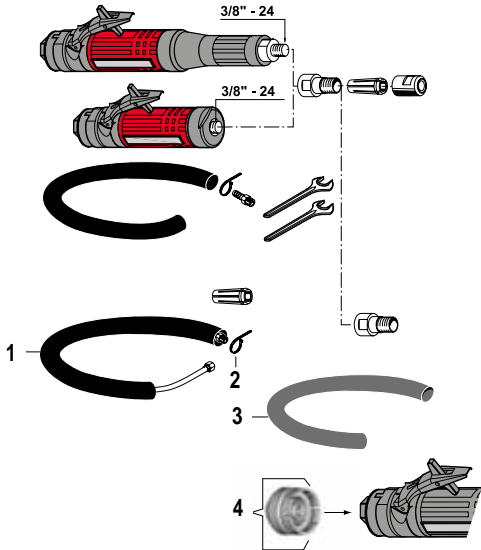

K6..-9 / K9..-9 / KC6..-9 / KC9..-9 / KA16120-9 / K1180-9

ACCESSORIES INCLUDED

	K/KC6 / K/KC9 KA16120-9	K1180-9
• Series 200 resilient collet, collet \varnothing 5.55 to 6.35mm (1/4")	615 526 063 0	615 526 063 0
• Series 200 resilient collet, collet \varnothing 8.7 to 9.5mm (3/8")		615 526 065 0
• Exhaust hose L = 1.5m (60")	615 875 113 0	
• Clamp	615 873 415 0	
• 3/8" air hose nipple for 10mm (3/8") ID hose	615 704 017 0	
• 3/8" air hose nipple for 13mm (1/2") ID hose for KA16120-9	615 704 027 0	
• 1/2" air hose nipple for 16mm (5/8") ID hose		615 704 014 0
• Flat wrench, 14mm	615 801 005 0	615 801 005 0
• Flat wrench, 19mm (3/4")	615 801 076 0	615 801 076 0
• Side handle for KA16120-9	615 576 038 0	

OPTIONAL ACCESSORIES

ITEM	K/KC6 / K/KC9 KA16120-9	K1180-9
• Series 200 resilient collet, collet \varnothing 2.4 to 3.2mm (1/8")	615 526 061 0	615 526 061 0
• Series 200 resilient collet, collet \varnothing 5.2 to 6mm	615 526 062 0	615 526 062 0
• Series 200 resilient collet, collet \varnothing 7.2 to 8mm	615 526 064 0	615 526 064 0
• Series 200 resilient collet, collet \varnothing 8.7 to 9.5mm (3/8")	615 526 065 0	
1 Vibration-damping handle for KA16120-9	615 576 066 0	
2 Complete silencer kit	615 396 166 0	
3 Clamp	615 873 115 0	
4 Reinforced cloth-lined exhaust hose L = 0.75m (30")	615 875 116 0	
5 Silencer kit		615 399 459 0
6 Clippable silencer	615 396 655 0	
6 Clippable silencer for KA16120-9	615 396 957 0	
7 Grease gun (capacity 24g - 0.8oz) for KA16120-9	615 990 149 0	
• Grease for bevel gear (1kg - 2.2lb) for KA16120-9	615 990 148 0	

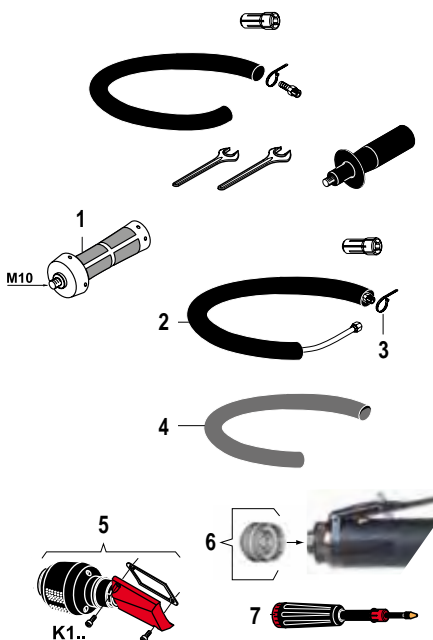

Grinders for carbide burrs and mounted points

600 to 1700 Watts (0.8 to 2.3 hp) - 12000 to 28000 rpm



Supplied with CNOMO collet, \varnothing 6mm

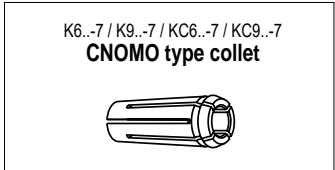

Supplied with series 200 resilient collet, \varnothing 5.55 to 6.35mm (1/4") & \varnothing 8.7 to 9.5mm (3/8")

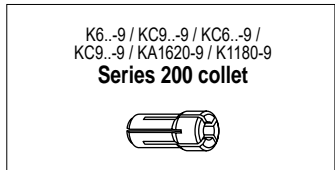

Caution: comply with the speeds recommended by component and abrasive manufacturers.

PIC REF	MODEL	PART NUMBER	FREE SPEED	COLLET MAX CAPACITY		POWER		WEIGHT		AIR CONSUMPTION				AIR INLET. THREAD		HOSE INT. \varnothing	
				rpm	mm	in.	W	hp	kg	lb.	l/s	cfm	l/s	cfm	in.	mm	in.

CNOMO collet

A	K628-7	615 170 107 0	28000	8	5/16	600	0.80	1.3	2.9	16	34	15	32	3/8	10	3/8
A	K624-7	615 170 106 0	24000	8	5/16	600	0.80	1.3	2.9	10	21	15	32	3/8	10	3/8
A	K922-7	615 170 119 0	22000	8	5/16	900	1.21	1.4	3.1	13	28	18	38	3/8	10	3/8
A	K619-7	615 170 105 0	19000	8	5/16	600	0.80	1.3	2.9	6	13	15	32	3/8	10	3/8
A	K918-7	615 170 117 0	18000	8	5/16	900	1.21	1.4	3.1	10	21	18	38	3/8	10	3/8
A	K615-7	615 170 104 0	15000	8	5/16	600	0.80	1.3	2.9	6	13	15	32	3/8	10	3/8
A	K915-7	615 170 114 0	15000	8	5/16	900	1.21	1.4	3.1	8	17	17	36	3/8	10	3/8
A	K912-7	615 170 110 0	12000	8	5/16	900	1.21	1.4	3.1	6	13	16	34	3/8	10	3/8
B	KC628-7	615 170 126 0	28000	8	5/16	600	0.80	0.9	2.0	16	34	15	32	3/8	10	3/8
B	KC624-7	615 170 125 0	24000	8	5/16	600	0.80	0.9	2.0	10	21	15	32	3/8	10	3/8
B	KC922-7	615 170 130 0	22000	8	5/16	900	1.21	1.0	2.2	13	28	18	38	3/8	10	3/8
B	KC619-7	615 170 124 0	19000	8	5/16	600	0.80	0.9	2.0	6	13	15	32	3/8	10	3/8
B	KC918-7	615 170 129 0	18000	8	5/16	900	1.21	1.0	2.2	10	21	18	38	3/8	10	3/8
B	KC615-7	615 170 123 0	15000	8	5/16	600	0.80	0.9	2.0	6	13	15	32	3/8	10	3/8
B	KC915-7	615 170 128 0	15000	8	5/16	900	1.21	1.0	2.2	8	17	17	36	3/8	10	3/8
B	KC912-7	615 170 127 0	12000	8	5/16	900	1.21	1.0	2.2	6	13	16	34	3/8	10	3/8
C	K912-300-7	615 170 108 0	12000	8	5/16	900	1.21	2.1	4.6	6	13	16	34	3/8	10	3/8
C	K912-500-7	615 170 109 0	12000	8	5/16	900	1.21	2.7	5.9	6	13	16	34	3/8	10	3/8

SERIES 200 collet

D	K628-9	615 170 150 0	28000	9.5	3/8	600	0.80	1.3	2.9	16	34	15	32	3/8	10	3/8
D	K624-9	615 170 151 0	24000	9.5	3/8	600	0.80	1.3	2.9	10	21	15	32	3/8	10	3/8
D	K922-9	615 170 152 0	22000	9.5	3/8	900	1.21	1.4	3.1	13	28	18	38	3/8	10	3/8
D	K619-9	615 170 153 0	19000	9.5	3/8	600	0.80	1.3	2.9	6	13	15	32	3/8	10	3/8
D	K918-9	615 170 154 0	18000	9.5	3/8	900	1.21	1.4	3.1	10	21	18	38	3/8	10	3/8
D	K615-9	615 170 155 0	15000	9.5	3/8	600	0.80	1.3	2.9	6	13	15	32	3/8	10	3/8
D	K915-9	615 170 156 0	15000	9.5	3/8	900	1.21	1.4	3.1	8	17	17	36	3/8	10	3/8
D	K912-9	615 170 157 0	12000	9.5	3/8	900	1.21	1.4	3.1	6	13	16	34	3/8	10	3/8
E	KC628-9	615 170 158 0	28000	9.5	3/8	600	0.80	0.9	2.0	16	34	15	32	3/8	10	3/8
E	KC624-9	615 170 159 0	24000	9.5	3/8	600	0.80	0.9	2.0	10	21	15	32	3/8	10	3/8
E	KC922-9	615 170 160 0	22000	9.5	3/8	900	1.21	1.0	2.2	13	28	18	38	3/8	10	3/8
E	KC619-9	615 170 161 0	19000	9.5	3/8	600	0.80	0.9	2.0	6	13	15	32	3/8	10	3/8
E	KC918-9	615 170 162 0	18000	9.5	3/8	900	1.21	1.0	2.2	10	21	18	38	3/8	10	3/8
E	KC615-9	615 170 163 0	15000	9.5	3/8	600	0.80	0.9	2.0	6	13	15	32	3/8	10	3/8
E	KC915-9	615 170 164 0	15000	9.5	3/8	900	1.21	1.0	2.2	8	17	17	36	3/8	10	3/8
E	KC912-9	615 170 165 0	12000	9.5	3/8	900	1.21	1.0	2.2	6	13	16	34	3/8	10	3/8
F	K912-300-9	615 170 169 0	12000	9.5	3/8	900	1.21	2.1	4.6	6	13	16	34	3/8	10	3/8
F	K912-500-9	615 170 170 0	12000	9.5	3/8	900	1.21	2.7	5.9	6	13	16	34	3/8	10	3/8
G	KA16120-9	615 170 443 0	12000	9.5	3/8	1700	2.30	1.4	3.2	20	42	32	68	3/8	13	1/2
H	K1180-9	615 170 246 0	18000	9.5	3/8	1200	1.61	2.5	5.9	12	25	35	74	1/2	15	5/8

Accessories

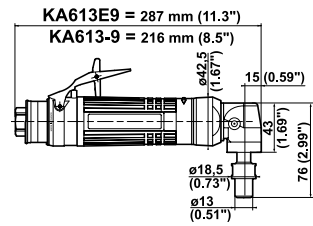
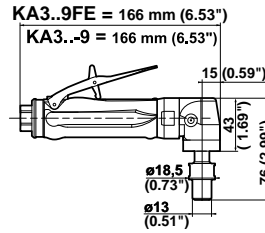
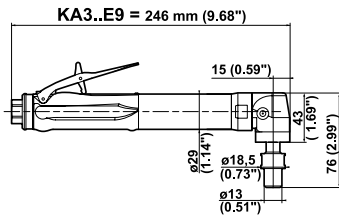
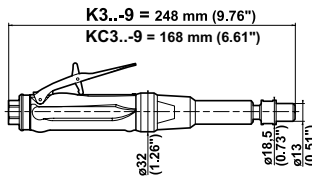

4734 / K3..-9 / KC3..-9 / KA3..E9 / KA3..-9 / KA3..-9FE

ACCESSORIES INCLUDED

ITEM	4734	K3../KC3..-9 KA3..E9/KA3..-9	KA3..-9FE
• Series 300 resilient collet, ϕ 2.4 to 3.2 mm	615 526 055 0	615 526 059 0	615 526 059 0
• Exhaust hose L = 0.8m (31")	222453	615 875 106 0	
• Clamp	235203		
• 1/4" air hose nipple for 8mm (5/16") ID hose		615 704 019 0	615 704 019 0
1 Clippable silencer			615 396 124 0
• Flat wrench, 11mm (7/16")	199003	615 801 003 0	615 801 003 0
• Flat wrench, 17mm (1-1/16")	615 801 032 0	615 801 032 0	615 801 032 0
• Flat wrench, 16mm (5/8" A/F)	18583		

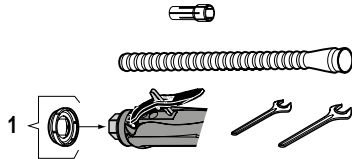

OPTIONAL ACCESSORIES

ITEM	4734	K3../KC3..-9 KA3..E9/KA3..-9	KA3..-9FE
• Series 300 resilient collet, ϕ 0.6 to 1.2mm	615 526 052 0	615 526 052 0	615 526 052 0
• Series 300 resilient collet, ϕ 1.2 to 2mm	615 526 053 0	615 526 053 0	615 526 053 0
• Series 300 resilient collet, ϕ 1.7 to 2.5mm	615 526 054 0	615 526 054 0	615 526 054 0
• Series 300 resilient collet, ϕ 2.4 to 3.2mm (1/8")	615 526 055 0	615 526 055 0	615 526 055 0
• Series 300 resilient collet, ϕ 3.16 to 3.96mm	615 526 056 0	615 526 056 0	615 526 056 0
• Series 300 resilient collet, ϕ 3.95 to 4.75mm	615 526 057 0	615 526 057 0	615 526 057 0
• Series 300 resilient collet, ϕ 4.75 to 5.55mm	615 526 058 0	615 526 058 0	615 526 058 0
2 Exhaust hose L = 0.8 m (31")			615 875 106 0
3 Complete silencer kit		615 396 101 0	615 396 101 0
4 Silencer		615 574 028 0	615 574 028 0
1 Clippable silencer		615 396 124 0	
5 Grease gun (capacity 24g - 0.8 oz.)		615 990 149 0	615 990 149 0
• Grease for bevel gear (1kg -2.2 lb.)		615 990 148 0	615 990 148 0

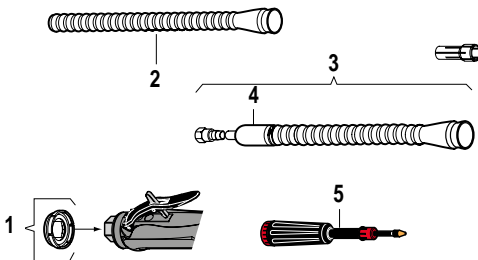

KA613E9 / KA613-9

ACCESSORIES INCLUDED

	PART NO.
• Series 300 resilient collet, ϕ 5.55 to 6.35mm (1/4")	615 526 059 0
• Exhaust hose L = 1.5m (60")	615 875 113 0
• Clamp	615 873 415 0
• 3/8" air hose nipple for 10mm (3/8") ID hose	615 704 017 0
• Flat wrench, 11mm (7/16")	615 801 003 0
• Flat wrench, 17mm (1-1/16")	615 801 032 0
• Grease gun (capacity 24g - 0.8 oz.)	615 990 149 0

OPTIONAL ACCESSORIES

ITEM	PART NO.
• Series 300 resilient collet, ϕ 0.4 to 1.2 mm (3/64")	615 526 052 0
• Series 300 resilient collet, ϕ 1.2 to 2 mm (5/64")	615 526 053 0
• Series 300 resilient collet, ϕ 1.7 to 2.5 mm (3/32")	615 526 054 0
• Series 300 resilient collet, ϕ 2.4 to 3.2 mm (1/8")	615 526 055 0
• Series 300 resilient collet, ϕ 3.16 to 3.96 mm (5/32")	615 526 056 0
• Series 300 resilient collet, ϕ 3.95 to 4.75 mm (3/16")	615 526 057 0
• Series 300 resilient collet, ϕ 4.75 to 5.55 mm (7/32")	615 526 058 0
1 Complete silencer kit	615 396 166 0
2 Clamp	615 873 115 0
3 Clippable silencer	615 396 655 0
4 Reinforced cloth-lined exhaust hose L = 0.75m (30")	615 875 116 0
• Grease for bevel gear (1 kg - 2.2 lb.)	615 990 148 0

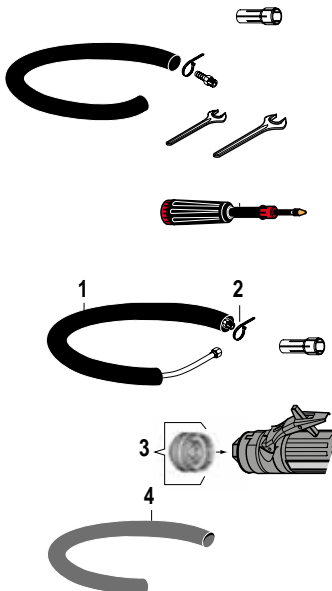

Grinders for carbide burrs, mounted points and sanding discs

300 to 600 Watts (0.4 to 0.8 hp) - 9000 to 40000 rpm

Supplied with series 300 resilient collet, \varnothing 5.55 to 6.35mm (1/4")

K3.-9 / KC3.-9 / KA3.(E)9 / KA3.-9FE / KA613(E)9
Series 300 collet



B



D



G



A

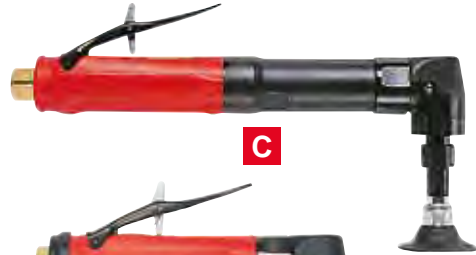

C



Front Exhaust **E**



F

Caution: comply with the speeds recommended by component and abrasive manufacturers.

PIC REF	MODEL	PART NUMBER	FREE SPEED	COLLET MAX CAPACITY		POWER		WEIGHT		AIR CONSUMPTION				AIR INLET THREAD		HOSE INT \varnothing	
				rpm	mm	in.	W	hp	kg	lb.	AT FREE SPEED	AT MAX OUTPUT	l/s	cfm	l/s	cfm	in.

STRAIGHT GRINDERS

A	K340-9	615 170 139 0	40000	6.35	1/4	375	0.5	0.57	1.26	7.5	16	10	21	1/4	8	5/16
A	K331-9	615 170 140 0	31000	6.35	1/4	375	0.5	0.57	1.26	4.5	9.5	9.5	20	1/4	8	5/16
A	K325-9	615 170 141 0	25000	6.35	1/4	375	0.5	0.57	1.26	3.5	7.5	9.5	20	1/4	8	5/16
A	K320-9	615 170 142 0	20000	6.35	1/4	375	0.5	0.57	1.26	2.5	5.0	8.0	17	1/4	8	5/16
B	KC340-9	615 170 143 0	40000	6.35	1/4	375	0.5	0.38	0.84	7.5	16	10	21	1/4	8	5/16
B	KC331-9	615 170 144 0	31000	6.35	1/4	375	0.5	0.38	0.84	4.5	9.5	9.5	20	1/4	8	5/16
B	KC325-9	615 170 145 0	25000	6.35	1/4	375	0.5	0.38	0.84	3.5	7.5	9.5	20	1/4	8	5/16
B	KC320-9	615 170 027 0	20000	6.35	1/4	375	0.5	0.38	0.84	2.5	5.0	8.0	17	1/4	8	5/16
B	KC318-9	615 170 196 0	18000	6.35	1/4	375	0.5	0.38	0.84	2.5	5.0	8.0	17	1/4	8	5/16

ANGLE GRINDERS

C	KA320E9	615 170 146 0	20000	6.35	1/4	375	0.5	0.61	1.35	6.5	13.5	10	21	1/4	8	5/16
C	KA312E9	615 170 147 0	12000	6.35	1/4	375	0.5	0.61	1.35	3.0	6.5	9.0	9	1/4	8	5/16
D	KA320-9	615 170 148 0	20000	6.35	1/4	375	0.5	0.51	1.13	6.5	13.5	10	21	1/4	8	5/16
D	KA318-9	615 170 461 0	18000	6.35	1/4	375	0.5	0.51	1.13	6.5	13.5	10	21	1/4	8	5/16
D	KA312-9	615 170 149 0	12000	6.35	1/4	375	0.5	0.51	1.13	3.0	6.5	9.0	19	1/4	8	5/16
D	KA309-9	615 170 266 0	9000	6.35	1/4	375	0.5	0.50	1.10	3.0	6.5	9.0	19	1/4	8	5/16
E	KA320-9FE*	615 170 206 0	20000	6.35	1/4	375	0.5	0.51	1.13	6.5	13.5	10	21	1/4	8	5/16
E	KA312-9FE*	615 170 205 0	12000	6.35	1/4	375	0.5	0.51	1.13	3.0	6.5	9.0	19	1/4	8	5/16
F	KA613E9	615 170 136 0	13000	6.35	1/4	600	0.8	1.40	3.10	10	21	15	32	3/8	10	3/8
G	KA613-9	615 170 135 0	13000	6.35	1/4	600	0.8	1.10	2.40	10	21	15	32	3/8	10	3/8

* Front Exhaust models

Routers

375 to 900 Watts (0.5 to 1.21 hp) - 12000 to 40000 rpm

375 W (0.5hp) - 20000 to 40000 rpm
CNOMO type collet



A

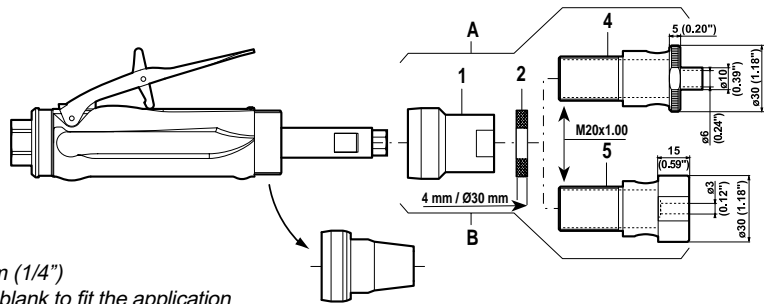

615 396 069 0: Machined routing kit for burr, max ø 6.4mm (1/4")
615 396 070 0: Blank routing kit allowing you to adapt the blank to fit the application

600 - 900 W (0.8 - 1.21hp) - 12000 to 28000 rpm
CNOMO type or Series 200 collet



B

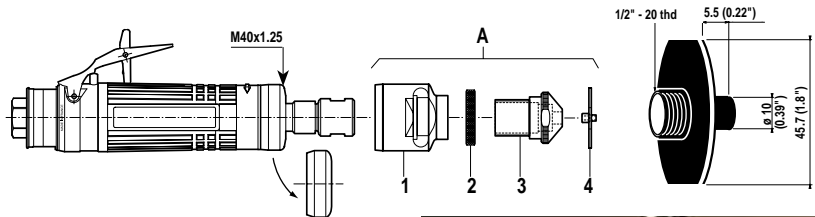

615 396 289 0: Machined routing kit for burr, max ø 6.4mm (1/4")



OPTIONAL ACCESSORIES

ITEM	KC3..	KC6.. / KC9..
A Machined routing kit	615 396 069 0	615 396 289 0
B Blank routing kit (item 1, 2, 5)	615 396 070 0	
1 Flange	615 595 231 0	615 595 245 0
2 Adjusting nut	615 607 140 0	615 607 145 0
• Circlip		615 687 056 0
• Bearing		615 758 127 0
3 Router nose		615 542 132 2
4 Machined routing guide	615 542 125 0	615 542 131 0
5 Blank routing guide	615 542 125 2	

If you need a complete tool use the KC624-9RT (24000 rpm) Part No. 615 170 290 0

If you need a specific speed or a higher power:

Select the motor, the speed of your choice below then add the routing kit.

For example: Tool with Series 200 collet - 900 W -22000 rpm (KC922-9) + routing kit Order 615 170 160 0 + 615 396 289 0

Caution: comply with the speeds recommended by component and abrasive manufacturers.

PIC REF	MODEL	FREE SPEED	POWER		PART NO.		ROUTING KIT	
			W	hp	CNOMO COLLET (-7)	SERIES 200 COLLET (-9)	MACHINED	BLANK

375 W (0.5 hp) - CNOMO type collet

A	KC340-7	40000	375	0.5	615 170 032 0	+		
A	KC331-7	31000	375	0.5	615 170 031 0	+		
A	KC325-7	25000	375	0.5	615 170 030 0	+		
A	KC320-7	20000	375	0.5	615 170 029 0	+		

615 396 069 0



615 396 070 0



600 - 900 W (0.8 - 1.21 hp) - CNOMO type or Series 200 collet

B	KC628-	28000	600	0.80	615 170 126 0	615 170 158 0	+	
B	KC624-	24000	600	0.80	615 170 125 0	615 170 159 0	+	
B	KC922-	22000	900	1.21	615 170 130 0	615 170 160 0	+	
B	KC619-	19000	600	0.80	615 170 124 0	615 170 161 0	+	
B	KC918-	18000	900	1.21	615 170 129 0	615 170 162 0	+	
B	KC615-	15000	600	0.80	615 170 123 0	615 170 163 0	+	
B	KC915-	15000	900	1.21	615 170 128 0	615 170 164 0	+	
B	KC912-	12000	900	1.21	615 170 127 0	615 170 165 0	+	

615 396 289 0



Collet Grinder Accessories



Aluminium Oxide Mounted Points are available in red grades. Red grades are suitable for grinding high tensile materials such as ordinary and alloy steels, high speed steel and annealed malleable iron.

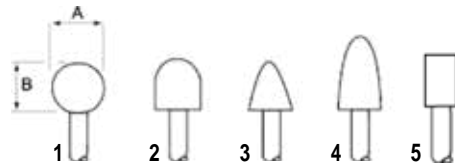
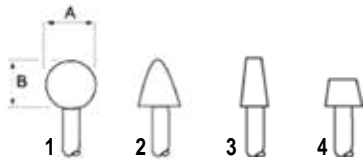

MOUNTED POINTS 3mm Ø SHANK - RED

Can also be used with collet type CNOMO or 200 & 300 Series (1/8")

PIC REF	MAX SPEED	A		B		PART NO.
		mm	in.	mm	in.	
1	104000	5	0.19	5	0.19	38582
2	104000	5	0.19	8	0.31	38522
3	105000	4	0.16	4	0.16	38562
4	81000	6	0.25	6	0.25	38542

MOUNTED POINTS 6mm Ø SHANK - RED

Can also be used with collet type CNOMO or 200 & 300 Series (1/4")

PIC REF	MAX SPEED	A		B		PART NO.
		mm	in.	mm	in.	
1	59000	16	0.62	16	0.62	435983
2	50000	20	0.79	16	0.62	435993
3	45000	20	0.79	28	1.10	436003
4	48000	20	0.79	32	1.26	436013
5	38000	25	1.00	3	0.11	

Recommended Speeds For Tungsten Carbide Burrs - rpm x 1000

MATERIAL	HEAD DIAMETER				
	3mm (1/8")	6mm (1/4")	10mm (3/8")	13mm (1/2")	16mm (5/8")
Alum, Zinc Base, Plastics	30-90	15-70	10-50	17-38	6-30
Cast Iron, Brass, Copper, Bronze	45-90	23-60	15-40	11-30	9-24
Mild Steel	60-90	45-60	30-40	22-30	18-24
Titanium, Stainless, Hardened Steels, Ceramics	60-90	30-45	19-30	15-22	12-18

Abrasive Discs Ø 50mm

SPEED	GRIT	PART NO.
rpm		
25000	P40	615 804 099 0
25000	P60	615 804 100 0
25000	P80	615 804 101 0
25000	P120	615 804 102 0



Accessories

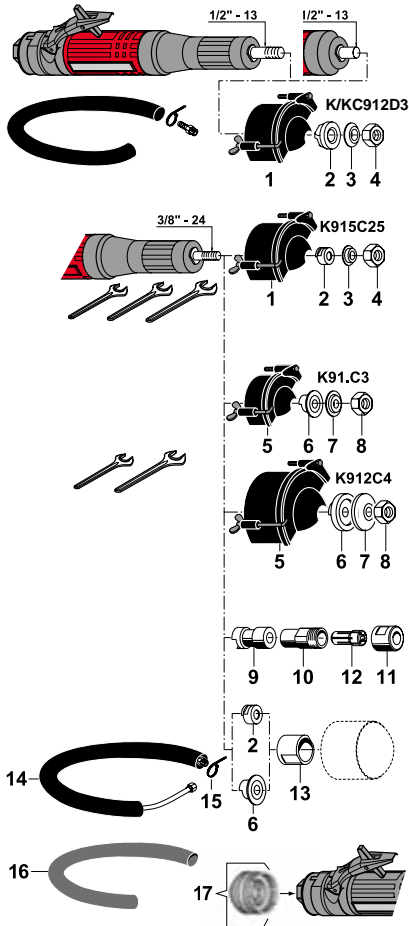
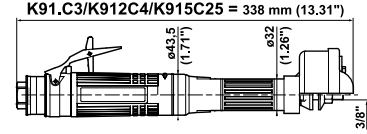
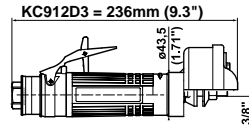
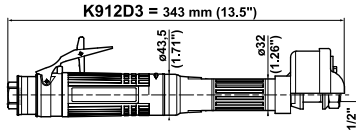

K9..

ACCESSORIES INCLUDED

ITEM	K/KC912D3 Ø 80mm (3")	K915C25 Ø 63mm (2 1/2")
• Exhaust hose L = 1.5m (60")	615 875 113 0	615 875 113 0
• Clamp	615 873 415 0	615 873 415 0
• 3/8" air hose nipple for 10mm ID hose	615 704 017 0	615 704 017 0
1 Wheel guard for K912D3	615 504 151 0	615 504 150 0
1 Wheel guard for KC912D3	615 504 214 0	
2 Rear flange	615 503 127 0	615 503 126 0
3 Front flange	615 502 044 0	615 502 043 0
4 Locknut	615 608 045 0	615 608 044 0
• Flat wrench 17mm (1-1/16")		615 801 032 0
• Flat wrench 14.3mm (9/16")		615 801 074 0
• Flat wrench 19mm (3/4")	615 801 076 0	

ITEM	K91.C3 Ø 80mm (3")	K912C4 Ø 100mm (4")
5 Wheel guard	615 504 151 0	615 504 152 0
6 Rear flange	615 503 125 0	615 503 131 0
7 Front flange	615 502 013 0	615 502 063 0
8 Locknut	615 608 044 0	615 608 044 0
• Flat wrench. 14.3mm (9/16")	615 801 074 0	615 801 074 0
• Flat wrench. 19mm (3/4")	615 801 076 0	615 801 076 0

OPTIONAL ACCESSORIES

ITEM		PART NO.
9	Spacer for collet-holder	615 666 149 0
10	Series 200 collet-holder	615 523 023 0
11	Series 200 collet nut	615 607 144 0
12	Series 200 Erickson collet	(see page 214)
13	Spacer for threaded cone wheel 3/8"	615 503 516 0
•	Rear flange supplied with tool 615 503 125 0 or 615 503 126 0	
14	Complete silencer kit	615 396 166 0
15	Clamp	615 873 115 0
16	Reinforced cloth-lined exhaust hose L = 0.75 m (30")	615 875 116 0
17	Clippable silencer	615 396 655 0



Grinders for cone wheels and type 1 wheels

Ø 63mm (2-1/2") - Ø 80mm (3") - Ø 100mm (4")

900 Watts (1.21 hp) - 12000 to 18000 rpm



A



B



C



D



E

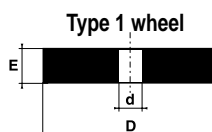

Wheel type 16 - 18 - 18R and 19

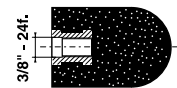

* Reinforced resinoid wheel

Caution: comply with the speeds recommended by component and abrasive manufacturers.

PIC REF	MODEL	PART NUMBER	FREE SPEED	WHEEL MAX CAPACITY		THREADED SPINDLE	POWER		WEIGHT		AIR CONSUMPTION				AIR INLET. THREAD	HOSE INT. Ø	
				D	xExd		W	hp	kg	lb.	AT FREE SPEED		AT MAX OUTPUT			in.	mm
			rpm	mm	in.	in.					l/s	cfm	l/s	cfm		mm	in.
A	K918C3	615 170 118 0	18000	*80x13x9.52	3x1/2x3/8	3/8-24	900	1.21	1.7	3.7	7	15	16	34	3/8	10	3/8
A	K915C3	615 170 116 0	15000	*80x13x9.52	3x1/2x3/8	3/8-24	900	1.21	1.7	3.7	7	15	16	34	3/8	10	3/8
A	K912C3	615 170 111 0	12000	*80x13x9.52	3x1/2x3/8	3/8-24	900	1.21	1.7	3.7	7	15	16	34	3/8	10	3/8
B	K915C25	615 170 115 0	15000	63x13x9.52	2-1/2x1/2x3/8	3/8-24	900	1.21	1.6	3.5	7	15	16	34	3/8	10	3/8
C	K912D3	615 170 113 0	12000	80x20x12.7	3x25/32x1/2	1/2-13	900	1.21	1.7	3.7	7	15	16	34	3/8	10	3/8
D	KC912D3	615 170 491 0	12000	80x20x12.7	3x25/32x1/2	1/2-13	900	1.21	1.3	2.9	7	15	16	34	3/8	10	3/8
E	K912C4	615 170 112 0	12000	100x13x9.52	4x1/2x3/8	3/8-24	900	1.21	1.8	4.0	7	15	16	34	3/8	10	3/8

3/8"-24 UNF - 1/2"-13 UNC

Accessories

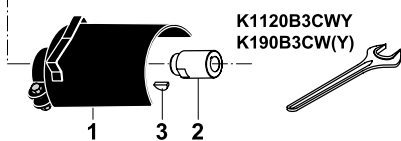
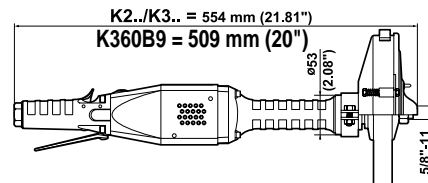
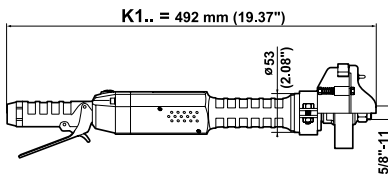
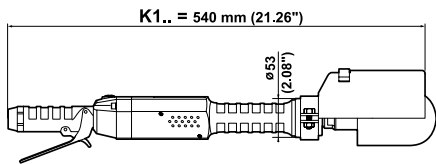

K1120B3CWY / K190B3CW(CWY) - \varnothing 80mm (3'')

ACCESSORIES INCLUDED

ITEM	PART NO.
• 1/2" air hose nipple for 16mm (5/8") ID hose	615 704 014 0
1 Wheel guard	615 504 080 0
2 Rear flange	615 503 095 0
3 Woodruff key	615 630 019 0
• Flat wrench, 27mm (1-1/16")	615 801 077 0

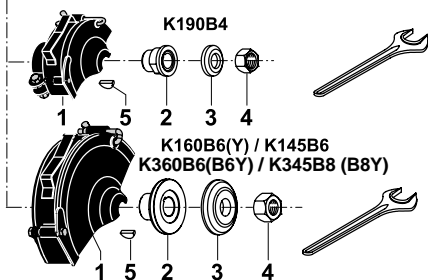

K190B4 / K.60B6(B6Y) / K145B6 / K345B8(B8Y)

ACCESSORIES INCLUDED

ITEM	K190B4 \varnothing 100 mm (4'')	K.60B6 (B6Y) K145B6 \varnothing 150 mm (6'')	K345B8 (B8Y) \varnothing 200 mm (8'')
• 1/2" air hose nipple for 16mm (5/8") ID hose	615 704 014 0	615 704 014 0	615 704 014 0
1 Wheel guard	615 504 154 0	615 504 079 0	615 504 078 0
2 Rear flange	615 503 094 0	615 503 028 0	615 503 004 0
3 Front flange	615 502 046 0	615 502 027 0	615 502 007 0
4 Nut	615 608 006 0	615 608 006 0	615 608 006 0
5 Woodruff key	615 630 019 0	615 630 019 0	615 630 019 0
• Flat wrench, 27mm (1-1/16")	615 801 077 0	615 801 077 0	615 801 077 0

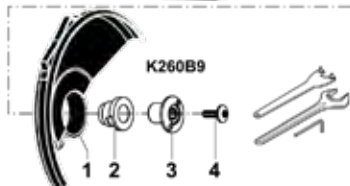

K360B9 - \varnothing 230 mm (9'')

ACCESSORIES INCLUDED

ITEM	PART NO.
• 1/2" air hose nipple for 16mm (5/8") ID hose	615 704 014 0
1 Wheel guard	615 504 161 0
2 Rear flange	615 503 103 0
3 Nut	615 542 104 0
4 Safety screw	615 614 034 0
• Pin wrench, 35mm (1-3/8")	615 802 010 0
• Flat wrench, 27mm (1-1/16")	615 801 077 0
• Hex. key 6 mm	615 802 056 0

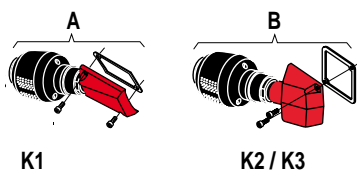

OPTIONAL ACCESSORIES

ITEM	K1..	K2.. / K3..
A Silencer kit	615 399 459 0	
B Silencer kit		615 399 460 0



Grinders for cone wheels and type 1 wheels ø 80mm (3") - ø 100mm (4") - ø 150mm (6") ø 200mm (8") - ø 230mm (9")

1000 to 2700 Watts (1.34 to 3.62 hp) - 4500 to 12000 rpm



A



B



C



D



E

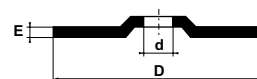

Type 27-42 wheel



F

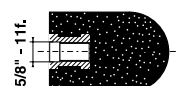

Wheel, type 16 - 18 - 18R and 19

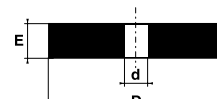

Type 1 wheel

Caution: comply with the speeds recommended by component and abrasive manufacturers.

PIC REF	MODEL	PART NUMBER	FREE SPEED	WHEEL MAX CAPACITY		THREADED SPINDLE	POWER		WEIGHT		AIR CONSUMPTION				AIR INLET THREAD		HOSE INT. Ø	
				rpm	mm		in.	in.	W	hp	kg	lb.	l/s	cfm	l/s	cfm	in.	mm
A	K190B3CW	615 170 005 0	9000	80	3	5/8-11	1200	1.61	3.5	7.7	9	19	27	57	1/2	15	5/8	
B	K190B4	615 170 004 0	9000	100x25x15.9	4x1x5/8	5/8-11	1200	1.61	3.2	7.0	9	19	27	57	1/2	15	5/8	
C	K160B6	615 170 003 0	6000	150x25x15.9	6x1x5/8	5/8-11	1200	1.61	3.5	7.7	6	12	23	48	1/2	15	5/8	
C	K145B6	615 170 002 0	4500	150x25x15.9	6x1x5/8	5/8-11	1000	1.34	3.5	7.7	5	10	20	42	1/2	15	5/8	
D	K360B6	615 170 010 0	6000	150x25x15.9	6x1x5/8	5/8-11	2700	3.62	5.6	12.3	13	27	41	86	1/2	15	5/8	
E	K345B8	615 170 009 0	4500	200x25x15.9	8x1x5/8	5/8-11	2400	3.22	6.3	13.9	8	17	33	70	1/2	15	5/8	
F	K360B9	615 170 521 0	6000	230x6.4x22.2	9x1/4x7/8	5/8-11	2700	3.62	5.6	12.3	13	27	41	86	1/2	15	5/8	
For USA Market only (to ANSI B186.1)																		
A	K1120B3CWY	615 170 171 0	12000	80	3	5/8-11	1300	1.74	3.0	6.6	16	34	30	64	1/2	15	5/8	
A	K190B3CWY	615 170 172 0	9000	80	3	5/8-11	1200	1.61	3.0	6.6	9	19	27	57	1/2	15	5/8	
C	K160B6Y	615 170 173 0	6000	150x25x15.9	6x1x5/8	5/8-11	1200	1.61	3.5	7.7	6	12	23	48	1/2	15	5/8	
D	K360B6Y	615 170 177 0	6000	150x25x15.9	6x1x5/8	5/8-11	2700	3.62	5.6	12.3	13	27	41	86	1/2	15	5/8	
E	K345B8Y	615 170 178 0	4500	200x25x15.9	8x1x5/8	5/8-11	2400	3.22	6.3	13.9	8	17	33	70	1/2	15	5/8	

5/8"-11 UNC

Accessories

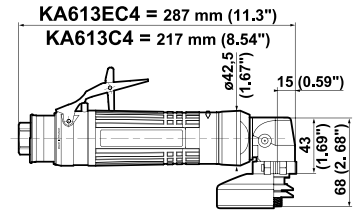
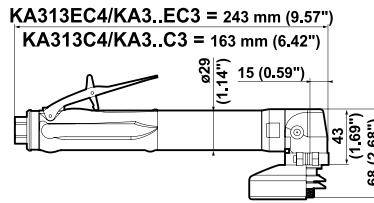
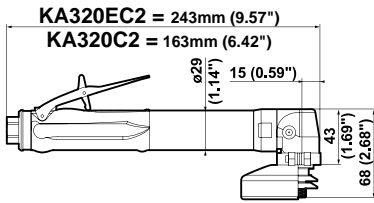

KA320EC2/C2 / KA3..EC3/C3 / KA313EC4/C4C

ACCESSORIES INCLUDED

ITEM	KA3..EC2 KA320C2 Ø 51mm (2")	KA3..EC3 KA3..C3 Ø 76mm (3")	KA313EC4 KA313C4 Ø 100mm (4")
• Exhaust hose L = 0.8m (31")	615 875 106 0	615 875 106 0	615 875 106 0
• 1/4" air hose nipple for 8mm ID hose	615 704 019 0	615 704 019 0	615 704 019 0
1 Wheel guard	615 504 207 0	615 504 155 0	615 504 160 0
2 Flange			615 606 515 0
3 Flange		615 502 064 0	615 502 064 0
4 Flange		615 503 144 0	615 503 144 0
5 Flange	615 502 082 0		
6 Nut	894 016 276 5		
• Pin wrench, 20-3mm		615 802 008 0	615 802 008 0
• Pin wrench	615 802 008 0		
• Flat wrench, 11mm (7/16")	615 801 003 0	615 801 003 0	615 801 003 0

OPTIONAL ACCESSORIES

ITEM	PART NO.
7 Complete silencer kit	615 396 101 0
8 Silencer	615 574 028 0
9 Clippable silencer	615 396 124 0
10 Grease gun includes (24g - 0.8oz)	615 990 149 0
• Grease for bevel gear (1kg - 2.2lb)	615 990 148 0

KA613EC4 / KA613C4 - Ø 100mm (4")

ACCESSORIES INCLUDED

ITEM	KA613EC4 KA613C4
• Exhaust hose L = 1.5m (60")	615 875 113 0
• Clamp	615 873 415 0
• 3/8" air hose nipple for 10mm ID hose	615 704 017 0
1 Wheel guard	615 504 160 0
2 Flange	615 606 515 0
3 Flange	615 502 064 0
4 Flange	615 503 144 0
5 Grease gun includes (24g - 0.8oz)	615 990 149 0
• Pin wrench, 20-3mm	615 802 008 0
• Flat wrench, 11mm (7/16")	615 801 003 0

OPTIONAL ACCESSORIES

ITEM	PART NO.
6 Complete silencer kit	615 396 166 0
7 Clamp	615 873 115 0
8 Reinforced cloth-lined exhaust hose L = 0.75m (30")	615 875 116 0
9 Clippable silencer	615 396 655 0
• Grease for bevel gear (1kg - 2.2lb)	615 990 148 0

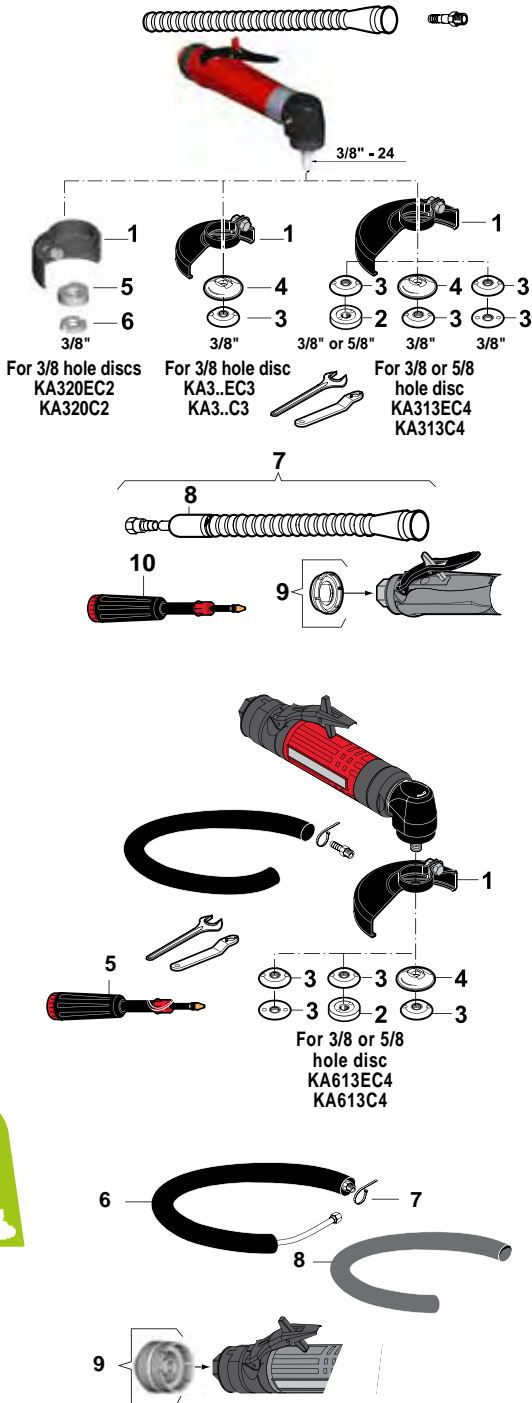

Grinders for depressed center wheels and cut-off wheels Ø 51mm (2") - Ø 76mm (3") - Ø 100mm (4")

375 and 600 Watts (0.5 and 0.8 hp) - 13000 to 20000 rpm

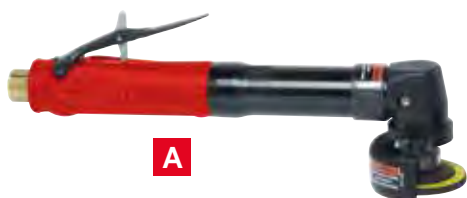

A



B



C



D



E



F



G



H

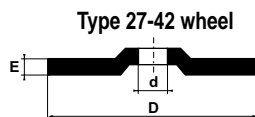

Type 27-42 wheel

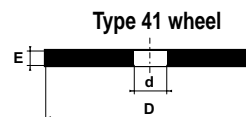

Type 41 wheel

Caution: comply with the speeds recommended by component and abrasive manufacturers

PIC REF	MODEL	PART NUMBER	FREE SPEED	WHEEL MAX CAPACITY DxE		THREADED SPINDLE	POWER		WEIGHT		AIR CONSUMPTION				AIR INLET THREAD		HOSE INT. Ø	
				mm	in.		W	hp	kg	lb.	AT FREE SPEED	AT MAX OUTPUT	in.	mm	in.			
A	KA320EC2	615 170 487 0	20000	51x7x9.52	2x1/4x3/8	3/8-24	375	0.5	0.81	1.78	6.5	13.5	10.0	21	1/4	8	5/16	
B	KA320EC3	615 170 046 0	20000	76x7x9.52	3x1/4x3/8	3/8-24	375	0.5	0.81	1.78	6.5	13.5	10.0	21	1/4	8	5/16	
B	KA318EC3	615 170 045 0	18000	76x7x9.52	3x1/4x3/8	3/8-24	375	0.5	0.81	1.78	4.5	9.5	9.5	20	1/4	8	5/16	
C	KA313EC4	615 170 050 0	13000	100x7x9.52 & 15.9	4x1/4x3/8&5/8	3/8-24	375	0.5	0.83	1.83	3.0	6.5	9.0	19	1/4	8	5/16	
D	KA320C2	615 170 488 0	20000	51x7x9.52	2x1/4x3/8	3/8-24	375	0.5	0.64	1.41	6.5	13.5	10.0	21	1/4	8	5/16	
E	KA320C3	615 170 042 0	20000	76x7x9.52	3x1/4x3/8	3/8-24	375	0.5	0.64	1.41	6.5	13.5	10.0	21	1/4	8	5/16	
E	KA318C3	615 170 041 0	18000	76x7x9.52	3x1/4x3/8	3/8-24	375	0.5	0.64	1.41	4.5	9.5	9.5	20	1/4	8	5/16	
F	KA313C4	615 170 049 0	13000	100x7x9.52 & 15.9	4x1/4x3/8&5/8	3/8-24	375	0.5	0.66	1.45	3.0	6.5	9.0	19	1/4	8	5/16	
G	KA613EC4	615 170 138 0	13000	100x7x9.52 & 15.9	4x1/4x3/8&5/8	3/8-24	600	0.8	1.50	3.30	10.0	21.0	15.0	32	3/8	10	3/8	
H	KA613C4	615 170 137 0	13000	100x7x9.52 & 15.9	4x1/4x3/8&5/8	3/8-24	600	0.8	1.20	2.60	10.0	21.0	15.0	32	3/8	10	3/8	

3/8"-24 UNF

Accessories

KA16135C4FK = 238mm (9.37")

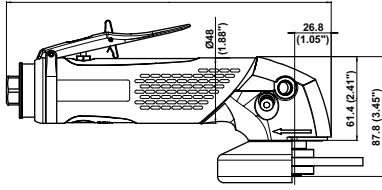

KA16120A45VK / B45VK = 238mm (9.37")

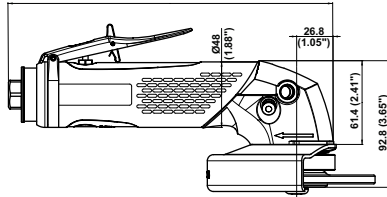

KA16120A45 / B45 = 238mm (9.37")

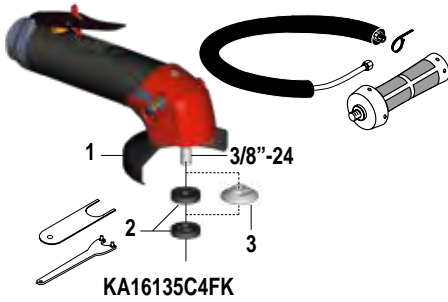
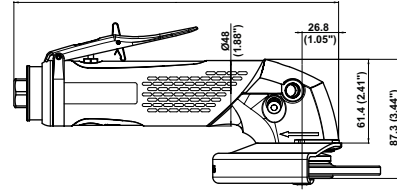

KA16135C4FK



KA16135C4FK - ø 100mm (4")

ACCESSORIES INCLUDED

ITEM	KA16135C4FK 3/8"-24
• Complete silencer kit	615 396 166 0
• Clamp	615 263 024 0
• Vibration-damping side handle	615 576 066 0
1 Wheel guard	615 504 196 0
2 Flange (Qty 2)	615 606 515 0
3 Rear flange	615 503 515 0
• Pin wrench 20-3mm	615 802 008 0
• Flat wrench, 16mm (5/8")	615 802 512 0

OPTIONAL ACCESSORIES

ITEM	PART NO.
4 Clippable silencer	615 396 957 0
5 Grease gun includes 24g (0.8oz)	615 990 149 0
• Grease for bevel gear (1 kg - 2.2 lb)	615 990 148 0

KA16120A45VK - KA16120B45VK - ø 115mm (4.5")

ACCESSORIES INCLUDED

ITEM	KA16120A45VK M14x2	KA16120B45VK 5/8" -11
• Complete silencer kit	615 396 166 0	615 396 166 0
• Clamp	615 263 024 0	615 263 024 0
• Vibration-damping side handle	615 576 066 0	615 576 066 0
1 Multi-position guard	615 504 195 0	615 504 195 0
2 Auto-balancer	615 990 181 0	615 990 181 0
3 Front flange	615 502 066 0	615 502 067 0
4 Safety screw	615 614 076 0	615 614 076 0
• Pin wrench, 35mm (1-3/8")	615 802 010 0	615 802 010 0
• Hex. key 6.35mm (1/4")	615 802 057 0	615 802 057 0

KA16120A45 - KA16120B45 - ø 115mm (4.5")

ACCESSORIES INCLUDED

ITEM	KA16120A45 M14x2	KA16120B45 5/8" -11
• Exhaust hose L = 1.5m (60")	615 875 113 0	615 875 113 0
• Clamp	615 263 024 0	615 263 024 0
• 3/8" air hose nipple for 13mm (1/2") ID hose	615 704 027 0	615 704 027 0
• Side handle	615 576 038 0	615 576 038 0
1 Multi-position guard	615 504 198 0	615 504 198 0
2 Rear flange	615 503 134 0	615 503 141 0
3 Front flange	615 502 066 0	615 502 067 0
4 Safety screw	615 614 076 0	615 614 076 0
• Pin wrench, 35mm (1-3/8")	615 802 010 0	615 802 010 0
• Hex. key 6.35mm (1/4")	615 802 057 0	615 802 057 0

OPTIONAL ACCESSORIES

ITEM	PART NO.
5 Complete silencer kit	615 396 166 0
6 Clamp	615 263 024 0
7 Reinforced cloth-lined exhaust hose L= 0.75m (30")	615 875 116 0
8 Vibration-damping side handle	615 576 066 0
9 Clippable silencer	615 396 957 0
10 Grease gun includes 24g (0.8oz)	615 990 149 0
• Grease for bevel gear (1 kg - 2.2lb)	615 990 148 0

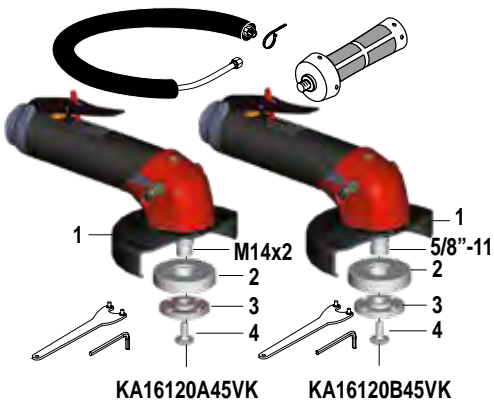

KA16120A45VK KA16120B45VK

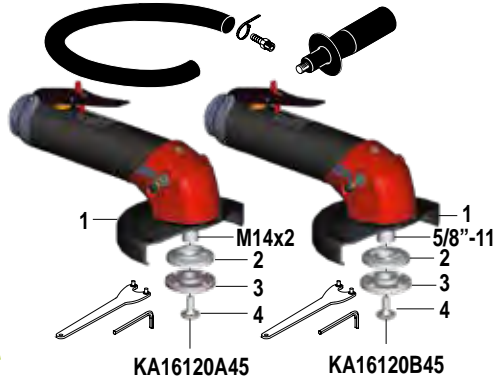

KA16120A45 KA16120B45

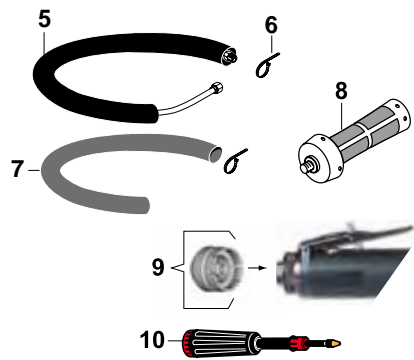

Grinders for depressed center wheels, cut-off wheels and flap wheel ø 100mm (4") - ø 115mm (4.5")

1700 Watts (2.3 hp) - 12000 and 13500 rpm



A



B

Fixed wheel guard

Multi-position guard



Type 27-42 wheel

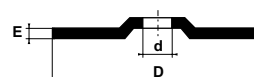

Type 41 wheel



Depressed centre flap wheels

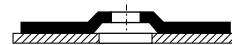

FLAT



CURVED

Caution: comply with the speeds recommended by component and abrasive manufacturers.

PIC REF	MODEL	PART NUMBER	FREE SPEED	WHEEL MAX CAPACITY DXEXD		THREADED SPINDLE	POWER		WEIGHT		AIR CONSUMPTION AT FREE SPEED		AIR CONSUMPTION AT MAX OUTPUT		AIR INLET THREAD	HOSE INT Ø		
				mm	in.		W	hp	kg	lb.	l/s	cfm	l/s	cfm		in.	mm	in
FIXED WHEEL GUARD																		
•	KA16135C4FK	615 170 441 0	13500	100x6.4x16	4x1/4x5/8	3/8-24	1700	2.3	1.53	3.4	25	53	35	74	3/8	13	1/2	
MULTI-POSITION GUARD																		
A	KA16120A45VK	615 170 456 0	12000	115x6.4x22.2	4.5x1/4x7/8	M14x2	1700	2.3	1.87	4.1	20	42	32	68	3/8	13	1/2	
A	KA16120B45VK	615 170 458 0	12000	115x6.4x22.2	4.5x1/4x7/8	5/8-11	1700	2.3	1.87	4.1	20	42	32	68	3/8	13	1/2	
B	KA16120A45	615 170 455 0	12000	115x6.4x22.2	4.5x1/4x7/8	M14x2	1700	2.3	1.75	3.9	20	42	32	68	3/8	13	1/2	
B	KA16120B45	615 170 457 0	12000	115x6.4x22.2	4.5x1/4x7/8	5/8-11	1700	2.3	1.75	3.9	20	42	32	68	3/8	13	1/2	

5/8"-11 UNC

Accessories

KA16120A5VK / B5VK = 238mm (9.37")

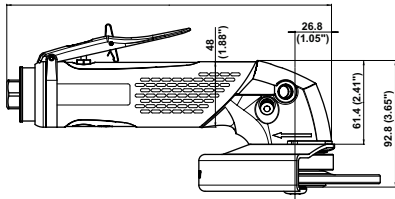

KA16120H5K / H5 = 238mm (9.37")

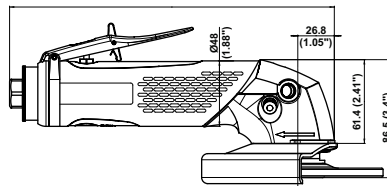

KA16120A5 / B5 = 238mm (9.37")

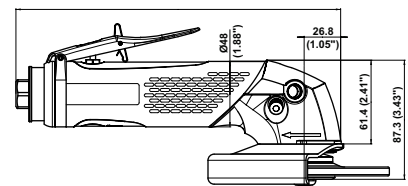

KA16120A5VK / B5VK / H5K - ø 127mm (5")

ACCESSORIES INCLUDED

ITEM	KA16120A5VK M14x2	KA16120B5VK 5/8-11	KA16120H5K Hex.
• Complete silencer kit	615 396 166 0	615 396 166 0	615 396 166 0
• Clamp	615 263 024 0	615 263 024 0	615 263 024 0
• Vibration-damping side handle	615 576 066 0	615 576 066 0	615 576 066 0
1 Multi-position guard	615 504 193 0	615 504 193 0	615 504 197 0
2 Auto-balancer	615 990 181 0	615 990 181 0	
3 Rear flange			615 503 124 0
4 Front flange	615 502 066 0	615 502 067 0	615 502 062 0
5 Safety screw	615 614 076 0	615 614 076 0	615 616 101 0
• Pin wrench, 35mm (1-3/8")	615 802 010 0	615 802 010 0	
• Hex. key 6mm			615 802 056 0
• Hex. key 6.35mm (1/4")	615 802 057 0	615 802 057 0	

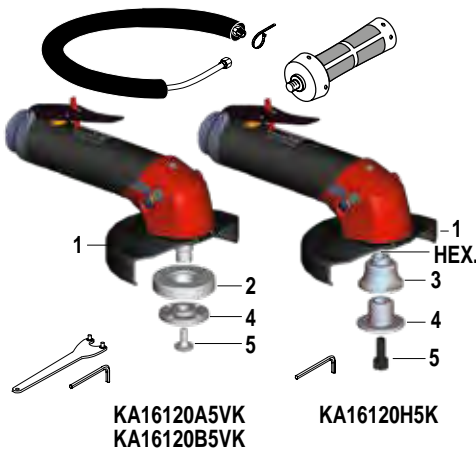

KA16120A5 / B5 / H5 - ø 127mm (5")

ACCESSORIES INCLUDED

ITEM	KA16120A5 M14x2	KA16120B5 5/8-11	KA16120H5 Hex.
• Exhaust hose L = 1.5m (60")	615 875 113 0	615 875 113 0	615 875 113 0
• Clamp	615 263 024 0	615 263 024 0	615 263 024 0
• 3/8" air hose nipple for 13mm (1/2") ID hose	615 704 027 0	615 704 027 0	615 704 027 0
• Side handle	615 576 038 0	615 576 038 0	615 576 038 0
1 Multi-position guard	615 504 197 0	615 504 197 0	615 504 197 0
2 Rear flange	615 503 134 0	615 503 141 0	615 503 124 0
3 Front flange	615 502 066 0	615 502 067 0	615 502 062 0
4 Safety screw	615 614 076 0	615 614 076 0	615 616 101 0
• Pin wrench, 35mm (1-3/8")	615 802 010 0	615 802 010 0	
• Hex. key 6mm			615 802 056 0
• Hex. key 6.35mm (1/4")	615 802 057 0	615 802 057 0	

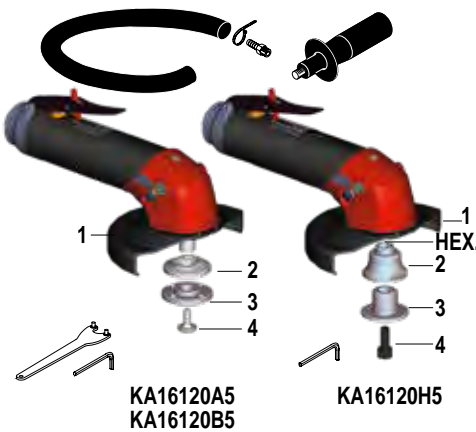

OPTIONAL ACCESSORIES

ITEM	PART NO.
5 Complete silencer kit	615 396 166 0
6 Clamp	615 263 024 0
7 Reinforced cloth-lined exhaust hose L = 0.75 m (30")	615 875 116 0
8 Vibration-damping side handle	615 576 066 0
9 Clippable silencer	615 396 957 0
10 Grease gun includes 24g (0.8oz)	615 990 149 0
• Grease for bevel gear (1kg - 2.2lb)	615 990 148 0

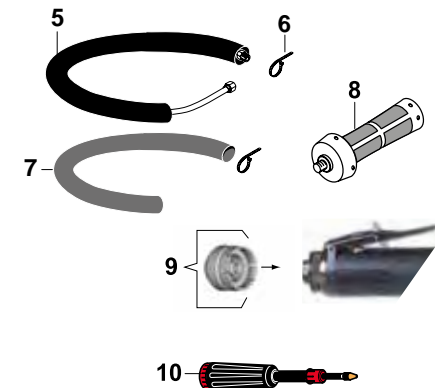

Grinders for depressed center wheels, cut-off wheels and flap wheels \varnothing 127mm (5")

1700 Watts (2.3 hp) - 12000 rpm

Quick wheel change

Multi-position guard



A



B



Type 27-42 wheel

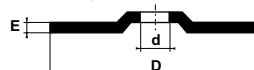

Type 41 wheel

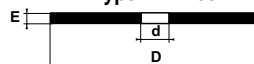

Depressed centre flap wheels

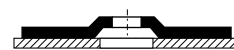

FLAT

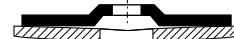

CURVED

Caution: comply with the speeds recommended by component and abrasive manufacturers.

PIC REF	MODEL	PART NUMBER	FREE SPEED	WHEEL MAX CAPACITY DXEXD		THREADED SPINDLE	POWER		WEIGHT		AIR CONSUMPTION AT FREE SPEED		AIR CONSUMPTION AT MAX OUTPUT		AIR INLET THREAD		HOSE INT \varnothing	
				mm	in.		W	hp	kg	lb.	l/s	cfm	l/s	cfm	in.	mm	in	
A	KA16120A5VK	615 170 438 0	12000	127x6.4x22.2	5x1/4x7/8	M14x2	1700	2.3	1.90	4.2	20	42	32	68	3/8	13	1/2	
A	KA16120B5VK	615 170 454 0	12000	127x6.4x22.2	5x1/4x7/8	5/8-11	1700	2.3	1.90	4.2	20	42	32	68	3/8	13	1/2	
A	KA16120H5K	615 170 434 0	12000	127x6.4x22.2	5x1/4x7/8	HEX	1700	2.3	1.77	3.9	20	42	32	68	3/8	13	1/2	
B	KA16120A5	615 170 437 0	12000	127x6.4x22.2	5x1/4x7/8	M14x2	1700	2.3	1.77	3.9	20	42	32	68	3/8	13	1/2	
B	KA16120B5	615 170 439 0	12000	127x6.4x22.2	5x1/4x7/8	5/8-11	1700	2.3	1.77	3.9	20	42	32	68	3/8	13	1/2	
B	KA16120H5	615 170 444 0	12000	127x6.4x22.2	5x1/4x7/8	HEX	1700	2.3	1.77	3.9	20	42	32	68	3/8	13	1/2	

5/8"-11 UNC

Accessories

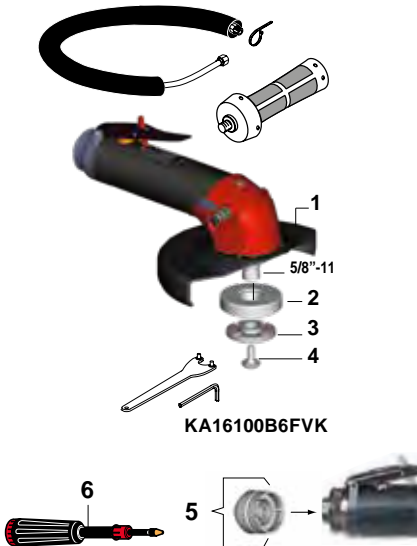
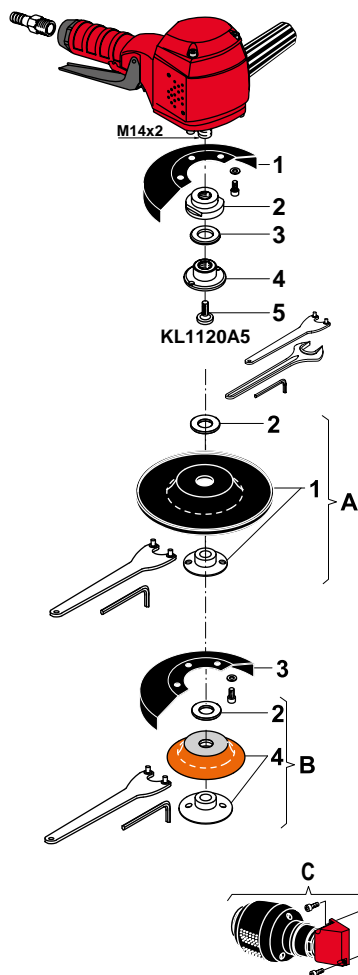
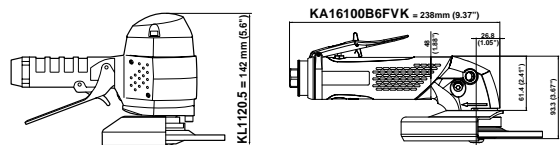

KL1120A5 - ø 127mm (5")

ACCESSORIES INCLUDED

ITEM		KL1120A5 M14x2 / 5/8"-11
	• 3/8" air hose nipple for 10mm (3/8") ID hose	615 704 017 0
1	Wheel guard	615 504 086 0
2	Rear flange	615 503 096 0
3	Washer for wheels thickness <2mm	615 642 052 0
4	Nut	615 606 032 0
5	Safety screw	615 614 033 0
	• Pin wrench, 35mm (1-3/8")	615 802 010 0
	• Flat wrench, 27mm (1-1/16")	615 801 077 0
	• Hex. key 6mm	615 802 056 0

OPTIONAL ACCESSORIES

SANDING WITH STANDARD ABRASIVE DISC ø 127MM (5")		KL1120A M14x2
A	Soft sanding kit for abrasive disc (including item 1-2)	615 399 251 0
1	Ventilated backing pad with nut M14 (max. 12000 rpm)	615 990 127 0
	• Pin wrench, 35mm (1-3/8")	615 802 010 0
	• Hex key 8mm (5/16")	615 802 061 0
2	M14 Spacer	615 641 027 0

SANDING WITH SEMIRIGID DISC ø 127MM (5")		KL1120A M14x2
3	Wheel guard	615 504 086 0
B	Sanding kit for semirigid disc (including item 4-2)	615 399 203 0
4	Backing pad with nut M14 (max. 12000 rpm)	615 990 129 0
2	M14 Spacer	615 641 027 0
	• Hex key 8mm (5/16")	615 802 061 0
	• Pin wrench, 35mm (1-3/8")	615 802 010 0

OTHER OPTIONAL ACCESSORIES

ITEM		PART NO.
C	Silencer kit	615 399 462 0

KA16100B6FVK - ø 150mm (6")

ACCESSORIES INCLUDED

ITEM		KA16100B6FVK 5/8"-11
	• Complete silencer kit	615 396 166 0
	• Vibration-damping side handle	615 576 066 0
	• Clamp	615 263 024 0
1	Wheel guard	615 504 202 0
2	Auto-balancer	615 990 181 0
3	Front flange	615 502 067 0
4	Safety screw	615 614 076 0
	• Pin wrench, 35mm (1-3/8")	615 802 010 0
	• Hex. key 6.35mm (1/4")	615 802 057 0

OPTIONAL ACCESSORIES

ITEM		KA16100B6FVK
5	Clippable silencer	615 396 957 0
6	Grease gun includes 24g (0.8oz)	615 990 149 0
	• Grease for bevel gear (1kg - 2.2lb)	615 990 148 0



Grinders for depressed center wheels, cut-off wheels and flap wheels \varnothing 127mm (5") - \varnothing 150mm (6")

750 and 1600 Watts (1 and 2.15 hp) - 10000 and 12000 rpm

Fixed wheel guard



A



B

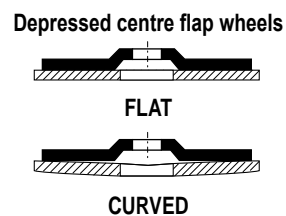
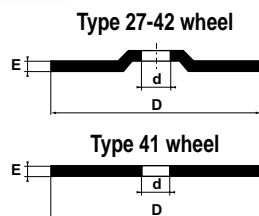

Caution: comply with the speeds recommended by component and abrasive manufacturers.

PIC REF	MODEL	PART NUMBER	FREE SPEED	WHEEL MAX CAPACITY DXEXD		THREADED SPINDLE	POWER		WEIGHT		AIR CONSUMPTION AT FREE SPEED		AIR CONSUMPTION AT MAX OUTPUT		AIR INLET THREAD		HOSE INT Ø	
				mm	in.		W	hp	kg	lb.	l/s	cfm	l/s	cfm	in.	mm	in	
A	KL1120A5	615 170 013 0	12000	127x6.4x22.2	5x1/4x7/8	M14x2	750	1.0	2.3	5.0	16	34	16	34	3/8	10	3/8	
B	KA16100B6FVK	615 170 470 0	10000	150x7.0x22.2	6x1/4x7/8	5/8-11	1600	2.15	1.9	4.2	20	42	32	68	3/8	13	1/2	

5/8"-11 UNC

Accessories

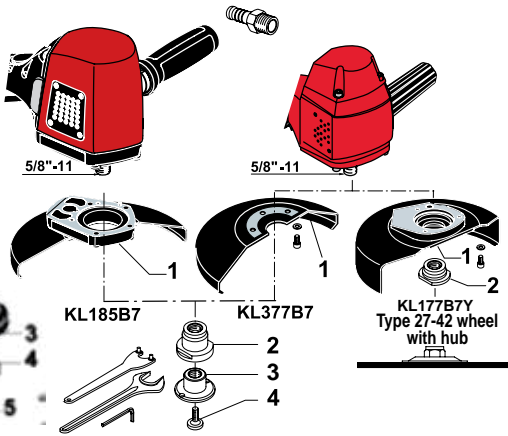
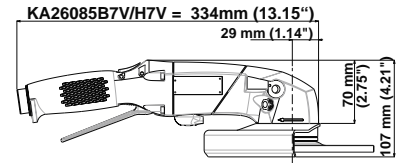
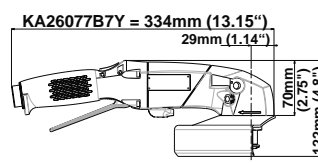
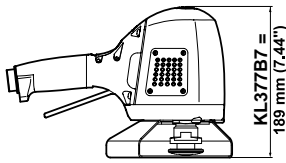
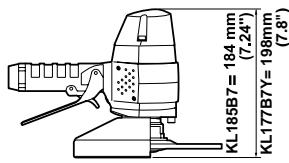

KL185B7 / KL377B7 / KL177B7Y - Ø 180mm (7")

ACCESSORIES INCLUDED

ITEM	KL185B7 Ø 180mm (7")	KL377B7 / V Ø 180mm (7")	KL177B7Y Ø 180mm (7")
• 1/2" air hose nipple for 16mm (5/8") ID hose	615 704 014 0		
• 1/2" air hose nipple for 13mm (1/2") ID hose	615 704 016 0		615 704 016 0
1 Wheel guard	615 504 095 0	615 504 182 0	615 504 169 0
2 Rear flange for model B7	615 503 103 0	615 503 103 0	615 503 150 0
3 Auto-balancer for model B7V		615 503 146 0	
4 Nut	615 542 104 0	615 542 104 0	615 608 049 0
5 Safety screw	615 614 034 0	615 614 034 0	615 614 034 0
• Pin wrench, 35mm (1-3/8")	615 802 010 0	615 802 010 0	
• Flat wrench, 27mm (1-1/16")	615 801 077 0	615 801 077 0	615 801 077 0
• Hex. key 6mm	615 802 056 0	615 802 056 0	615 802 056 0

KL360B6C / KL360B6CY - Ø 150mm (6")

ACCESSORIES INCLUDED

ITEM	KL360B6C	KL360B6CY
• 1/2" air hose nipple for 16mm (5/8") ID hose	615 704 014 0	615 704 014 0
1 Wheel guard	615 504 181 0	615 504 178 0
2 Rear flange	615 503 116 0	615 503 150 0
3 Safety screw	615 614 034 0	
4 Nut		615 608 049 0
• Lever		615 595 202 0
• Flat wrench. 27mm (11/16")	615 801 077 0	
• Hex. key	615 802 056 0	615 802 061 0

OTHER OPTIONAL ACCESSORIES

ITEM	KL185B7	KL377B7	KL177B7Y
A Silencer	615 399 462 0		615 399 462 0
B Silencer		615 399 463 0	
C Auto-Balancer	615 503 146 0		

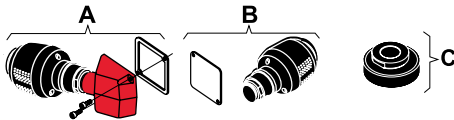

KA26085B7V / KA26085H7V / KA26077B7Y - Ø 180mm (7")

ACCESSORIES INCLUDED

ITEM	KA26085B7V	KA26085H7V	KA26077B7Y
• Vibration damping side handle	615 576 066 0	615 576 066 0	615 576 066 0
• 1/2" air hose nipple for 16mm (5/8") ID hose	615 704 014 0	615 704 014 0	615 704 014 0
• Rotating exhaust kit	615 397 743 5	615 397 743 5	615 397 743 5
• Rotating handle support kit	615 397 741 5	615 397 741 5	615 397 741 5
1 Wheel guard kit	615 504 211 5	615 504 211 5	615 504 213 5
2 Auto-balancer	615 990 181 0	615 990 194 0	
3 Rear flange		615 503 164 0	615 503 153 0
4 Front flange	615 502 067 0	615 502 085 0	
5 Nut 5/8"			615 608 049 0
6 Safety screw	615 614 076 0		615 614 034 0
• Pin wrench, 35mm (1-3/8")	615 802 010 0	615 802 010 0	
• Hex key	615 802 056 0	615 802 056 0	615 802 056 0

OPTIONAL ACCESSORIES

ITEM	KL177B7Y KA26077B7Y
7 Rear flange	615 503 103 0
8 Nut	615 542 104 0
9 Rear flange balancer	615 503 146 0
10 Safety screw	615 614 034 0
11 Wheel adaptor	C087920
• Pin wrench	615 802 010 0
• Flat wrench	615 801 077 0
• Hex key	615 802 056 0
12 Grease gun includes 24g (0.8oz)	615 990 149 0
• Grease for bevel gear (1kg - 2.2lb)	615 990 148 0

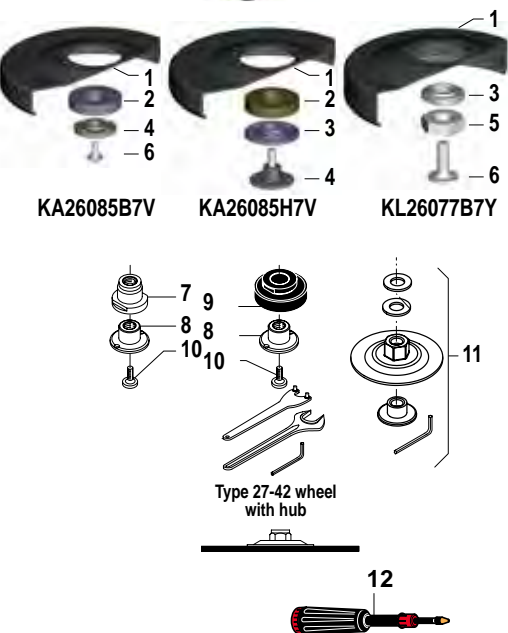

Grinders for depressed center wheels, cut-off wheels and flap wheels \varnothing 180mm (7")

1200 to 3000 Watts (1.61 to 4.02 hp) - 6000 to 8500 rpm



A



B



C



D



E



F

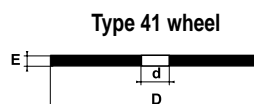
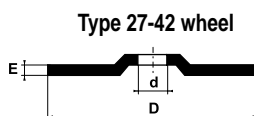

Depressed centre flap wheels

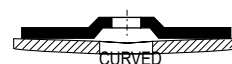

Caution: comply with the speeds recommended by component and abrasive manufacturers.

PIC REF	MODEL	PART NUMBER	FREE SPEED rpm	WHEEL MAX CAPACITY DxExd		THREADED SPINDLE in.	POWER		WEIGHT		AIR CONSUMPTION				AIR INLET THREAD		HOSE INT. Ø	
				mm	in.		W	hp	kg	lb.	AT FREE SPEED l/s cfm	AT MAX OUTPUT l/s cfm	in.	mm	in.			
VERTICAL GRINDERS																		
A	KL185B7	615 170 012 0	8500	180x9.5x22.2	7x3/8x7/8	5/8-11	1200	1.61	2.8	6.1	16	34	27	57	1/2	13	1/2	
B	KL377B7	615 170 341 0	7700	180x9.5x22.2	7x3/8x7/8	5/8-11	3000	4.02	4.2	9.2	19	40	46	97	1/2	15	5/8	
For USA Market only (to ANSI B186.1)																		
C	KL177B7Y	615 170 182 0	7700	180x9.5x22.2	7x3/8x7/8	5/8-11	1200	1.61	2.8	6.1	8	17	25	53	1/2	15	5/8	
LOW VIBRATION - VERTICAL GRINDERS																		
B	KL377B7V	615 170 472 0	7700	180x9.5x22.2	7x3/8x7/8	5/8-11	3000	4.02	4.3	9.4	19	40	46	97	1/2	15	5/8	
VERTICAL GRINDERS for cup wheels																		
D	KL360B6C	615 170 337 0	6000	150	6	5/8-11	2400	3.22	4.2	9.2	9	19	39	82	1/2	15	5/8	
For USA Market only (to ANSI B186.1)																		
D	KL360B6CY	615 170 351 0	6000	150	6	5/8-11	2900	3.89	4.4	9.7	12	25	43	91	1/2	15	5/8	
ANGLE GRINDERS																		
E	KA26085B7V	615 170 476 0	8500	180x9.5x22.2	7x3/8x7/8	5/8-11	2100	2.82	2.7	5.9	17	36	36	77	1/2	15	5/8	
E	KA26085H7V	615 170 489 0	8500	180x9.5x22.2	7x3/8x7/8	HEX.	2100	2.82	2.7	5.9	17	36	36	77	1/2	15	5/8	
For USA Market only (to ANSI B186.1)																		
F	KA26077B7Y	615 170 478 0	7700	180x9.5x22.2	7x3/8x7/8	5/8-11	2100	2.82	2.7	6.6	16	33	32	69	1/2	15	5/8	

5/8"-11 UNC

Accessories

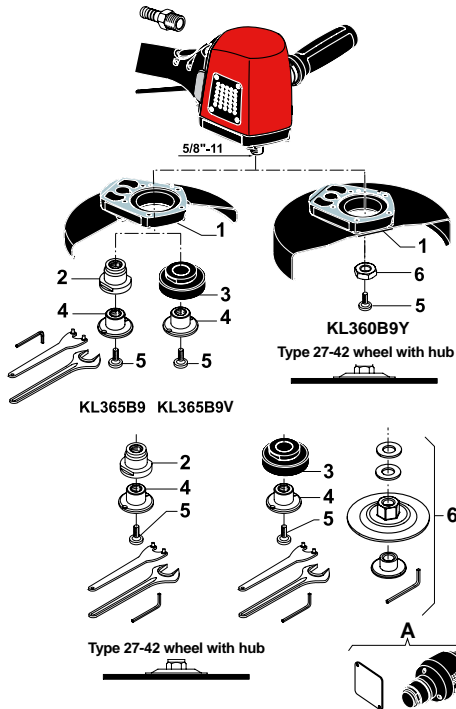
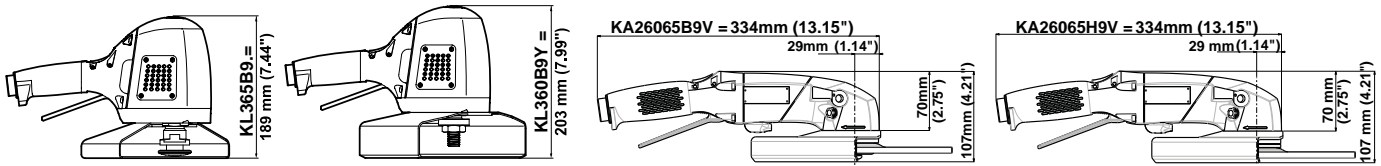

KL365B9 / KL365B9V / KL360B9Y - Ø 230mm (9")

ACCESSORIES INCLUDED

ITEM	KL365B9 KL365B9V	KL360B9Y
• 1/2" air hose nipple for 16 mm (5/8") ID hose	615 704 014 0	615 704 014 0
1 Wheel guard	615 504 183 0	615 504 180 0
2 Rear flange for model B9	615 503 103 0	
3 Auto-balancer for model B9V	615 503 146 0	
4 Nut	615 542 104 0	
5 Safety screw	615 614 034 0	615 614 034 0
6 Nut		615 608 049 0
• Flat wrench, 27mm (1-1/16")	615 801 077 0	615 801 077 0
• Pin wrench, 35mm (1-3/8")	615 802 010 0	
• Hex. Key 6mm	615 802 056 0	615 802 056 0

OPTIONAL ACCESSORIES

ITEM	KL365B9	KL360B9Y
2 Rear flange		615 503 103 0
3 Auto-balancer		615 503 146 0
4 Nut		615 542 104 0
5 Safety screw		615 614 034 0
6 Wheel adaptor		C087920
• Pin wrench, 35mm (1-3/8")		615 802 010 0
• Flat wrench, 27mm (1-1/16")		615 801 077 0
• Hex. Key 6mm		615 802 056 0
A Silencer kit	615 399 463 0	615 399 463 0



KA26065B9V / KA26065H9V - Ø 230mm (9")

ACCESSORIES INCLUDED

ITEM	KL365B9	KL360B9Y
• Vibration damping side handle	615 576 066 0	615 576 066 0
• 1/2" air hose nipple for 16mm (5/8") ID hose	615 704 014 0	615 704 014 0
• Rotating exhaust kit	615 397 743 5	615 397 743 5
• Rotating handle support kit	615 397 741 5	615 397 741 5
1 Wheel guard kit	615 504 212 5	615 504 212 5
2 Auto-balancer	615 990 181 0	615 990 194 0
3 Rear flange		615 503 164 0
4 Front flange	615 502 067 0	615 502 085 0
5 Safety screw	615 614 076 0	
• Pin wrench, 35mm (1-3/8")	615 802 010 0	615 802 010 0
• Hex key	615 802 056 0	615 802 056 0

OPTIONAL ACCESSORIES

ITEM	PART NO.
6 Grease gun includes 24g (0.8oz)	615 990 149 0
• Grease for bevel gear (1kg - 2.2lb)	615 990 148 0

Grinders for depressed center wheels

Ø 230mm (9")

2100 and 2900 Watts (2.82 and 3.89 hp) - 6000 and 6500 rpm



A



B



C

Type 27-42 wheel with hub

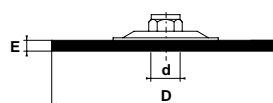

Type 27-42 wheel

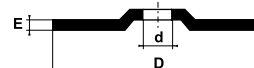

Type 41 wheel

Caution: comply with the speeds recommended by component and abrasive manufacturers.

PIC REF	MODEL	PART NUMBER	FREE SPEED	WHEEL MAX CAPACITY		THREADED SPINDLE	POWER		WEIGHT		AIR CONSUMPTION		AIR INLET THREAD		HOSE INT. Ø		
				D	x		Ex	W	hp	kg	lb.	l/s	cfm	l/s	cfm	in.	mm
VERTICAL GRINDERS																	
A	KL365B9	615 170 338 0	6500	230x6.4x22.2	9x1/4x7/8	5/8-11	2900	3.89	4.4	9.7	13	27	44	93	1/2	15	5/8
For USA Market only (to ANSI B186.1)																	
B	KL360B9Y	615 170 350 0	6000	230x6.4x22.2	9x1/4x7/8	5/8-11	2900	3.89	4.4	9.7	12	25	43	91	1/2	15	5/8
LOW VIBRATION - VERTICAL GRINDERS																	
A	KL365B9V	615 170 474 0	6500	230x6.4x22.2	9x1/4x7/8	5/8-11	2900	3.89	4.5	9.9	13	27	44	93	1/2	15	5/8
ANGLE GRINDERS																	
C	KA26065B9V	615 170 477 0	6500	230x6.4x22.2	9x1/4x7/8	5/8-11	2100	2.82	2.9	6.4	21	44	38	80	1/2	15	5/8
C	KA26065H9V	615 170 490 0	6500	230x6.4x22.2	9x1/4x7/8	HEX.	2100	2.82	2.9	6.4	21	44	38	80	1/2	15	5/8

5/8"-11 UNC



Accessories

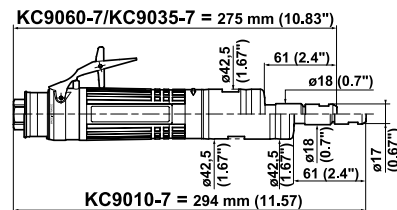
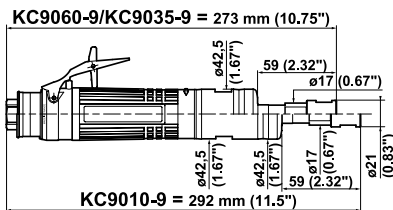

KC9060-9 / KC9035-9 / KC9010-9

ACCESSORIES INCLUDED

	PART NO.
• Series 200 resilient collet, ϕ 5.55 to 6.35mm (1/4")	615 526 063 0
• Exhaust hose L = 1.5m (60")	615 875 113 0
• Clamp	615 873 415 0
• 3/8" air hose nipple for 10mm (3/8") ID hose	615 704 017 0
• Flat wrench, 14mm	615 801 005 0
• Flat wrench, 19mm (3/4")	615 801 076 0
• Side handle	615 576 068 0

OPTIONAL ACCESSORIES

ITEM	PART NO.
• Series 200 resilient collet, ϕ 2.4 to 3.2mm (1/8")	615 526 061 0
• Series 200 resilient collet, ϕ 5.2 to 6mm	615 526 062 0
• Series 200 resilient collet, ϕ 7.2 to 8mm (5/16")	615 526 064 0
• Series 200 resilient collet, ϕ 8.7 to 9.5mm (3/8")	615 526 065 0
1 Nut 3/8" - 24	615 608 044 0
2 Complete silencer kit	615 396 166 0
3 Clamp	615 873 115 0
4 Reinforced cloth-lined exhaust hose L = 0.75m (30")	615 875 116 0
5 Clippable silencer	615 396 655 0

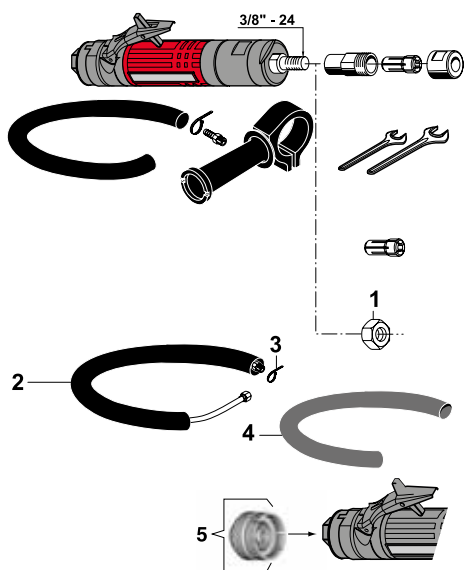

KC9060-7 / KC9035-7 / KC9010-7

ACCESSORIES INCLUDED

	PART NO.
• CNOMO collet ϕ 6mm	615 526 049 0
• Exhaust hose L = 1.5m (60")	615 875 113 0
• Clamp	615 873 415 0
• 3/8" air hose nipple for 10mm (3/8") ID hose	615 704 017 0
• Flat wrench, 14mm (Qty 2)	615 801 005 0
• Side handle	615 576 068 0

OPTIONAL ACCESSORIES

ITEM	PART NO.
• CNOMO collet ϕ 3mm	615 526 048 0
• CNOMO collet ϕ 6.35mm (1/4")	615 526 050 0
• CNOMO collet ϕ 8mm (5/16")	615 526 051 0
1 Nut 3/8" - 24	615 608 044 0
2 Complete silencer kit	615 396 166 0
3 Clamp	615 873 115 0
4 Reinforced cloth-lined exhaust hose L = 0.75m (30")	615 875 116 0
5 Clippable silencer	615 396 655 0

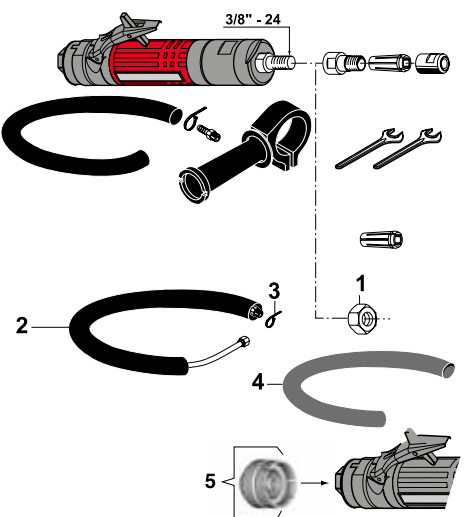

Sanders for expandable wheels, flap wheels, brushes

900 Watts (1.21 hp) - 1000 to 5500 rpm

Supplied with series 200 Erickson collet, Ø 5.55 to 6.35mm (1/4")



A



B

Series 200 Erickson collet



Caution: comply with the speeds recommended by component and abrasive manufacturers.

PIC REF	MODEL	PART NUMBER	FREE SPEED	COLLET MAX CAPACITY		POWER		WEIGHT		AIR CONSUMPTION				AIR INLET THREAD		HOSE INT. Ø	
				rpm	mm	in.	W	hp	kg	lb.	AT FREE SPEED		AT MAX. POWER		in.	mm	in.
A	KC9060-9	615 170 166 0	5500	9.5	3/8	900	1.21	1.38	3.0	10	21	16	34	3/8	10	3/8	
A	KC9035-9	615 170 167 0	3500	9.5	3/8	900	1.21	1.38	3.0	6	13	14	30	3/8	10	3/8	
B	KC9010-9	615 170 168 0	1000	9.5	3/8	900	1.21	1.45	3.2	10	21	16	34	3/8	10	3/8	

Sanders for expandable wheels, flap wheels, brushes...

900 Watts (1.21 hp) - 1000 to 5500 rpm

Supplied with CNOMO collet, Ø 6mm



A



B

CNOMO type collet



Caution: comply with the speeds recommended by component and abrasive manufacturers.

PIC REF	MODEL	PART NUMBER	FREE SPEED	COLLET MAX CAPACITY		POWER		WEIGHT		AIR CONSUMPTION				AIR INLET THREAD		HOSE INT. Ø	
				rpm	mm	in.	W	hp	kg	lb.	AT FREE SPEED		AT MAX. POWER		in.	mm	in.
A	KC9060-7	615 170 122 0	5500	8	5/16	900	1.21	1.38	3.0	10	21	16	34	3/8	10	3/8	
A	KC9035-7	615 170 121 0	3500	8	5/16	900	1.21	1.38	3.0	6	13	14	30	3/8	10	3/8	
B	KC9010-7	615 170 120 0	1000	8	5/16	900	1.21	1.45	3.2	10	21	16	34	3/8	10	3/8	

Accessories

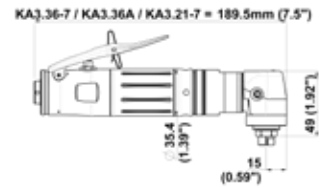
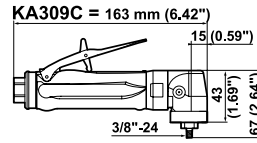
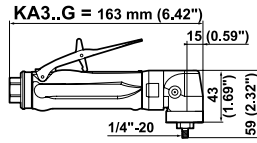
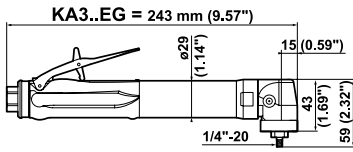

KA3..EG / KA3..G / KA309C

ACCESSORIES INCLUDED

	PART NO.
• Exhaust hose L = 0.8m (31")	615 875 106 0
• 1/4" air hose nipple for 8mm (5/16") ID hose	615 704 019 0
• Flat wrench, 11mm (7/16")	615 801 003 0

OPTIONAL ACCESSORIES

ITEM	KA309C 3/8"-24
1 Excentric sanding head for 1" pad	615 396 251 0

OTHER OPTIONAL ACCESSORIES

ITEM	PART NO.
2 Complete silencer kit	615 396 101 0
3 Silencer	615 574 028 0
4 Clippable silencer	615 396 124 0
5 Grease gun (capacity 24g - 0.8oz)	615 990 149 0
• Grease for bevel gear (1kg - 2.2lb)	615 990 148 0

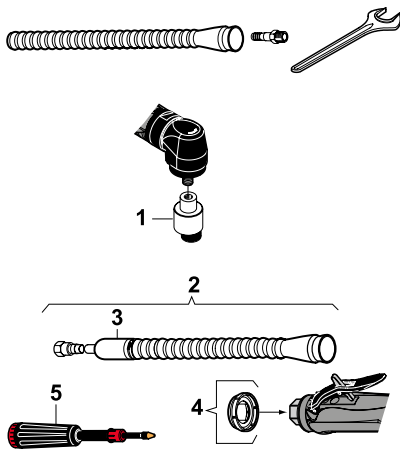

KA3.36A / KA3.36-7 / KA3.21-7

ACCESSORIES INCLUDED

	KA3.36A	KA3.36-7/KA3.21-7
• Collet \varnothing 6mm	-	615 526 079 0
• 1/4" air hose nipple for 6mm (1/4") ID hose	615 705 009 0	615 705 009 0
• Flat wrench, 10mm (3/8")	-	615 801 002 0
• Flat wrench, 14mm	-	615 801 005 0

OPTIONAL ACCESSORIES

ITEM	KA3.36A	KA3.36-7/KA3.21-7
1 Complete silencer kit	615 399 423 0	615 399 423 0
2 Exhaust hose L = 0.8m (31")	615 875 106 0	615 875 106 0
3 Backing pad \varnothing 50mm (31/32")		615 804 098 0
• Collet \varnothing 2mm		615 526 066 0
• Collet \varnothing 2.5mm		615 526 068 0
• Collet \varnothing 3mm		615 526 069 0
• Collet \varnothing 3.5mm		615 526 070 0
• Collet \varnothing 4mm (5/32")		615 526 071 0
• Collet \varnothing 4.5mm		615 526 073 0
• Collet \varnothing 5mm		615 526 075 0
• Collet \varnothing 5.5mm		615 526 077 0
• Collet \varnothing 6mm		615 526 079 0
• Collet \varnothing 6.5mm (1/4")		615 526 081 0
• Collet \varnothing 7mm		615 526 083 0
• Collet \varnothing 7.5mm		615 526 084 0
• Collet \varnothing 8mm (5/16")		615 526 088 0

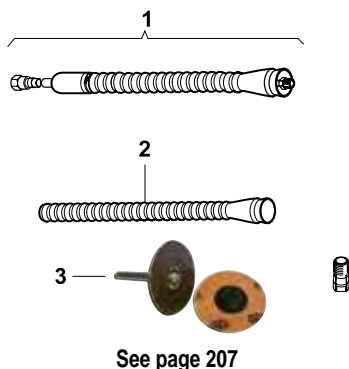

Sanders for abrasive discs

220 to 375 Watts (0.3 to 0.5 hp) - 2100 to 20000 rpm

Supplied with 1/4", 3/8" or M14 threaded spindle only



A



B



C

3/8"-24

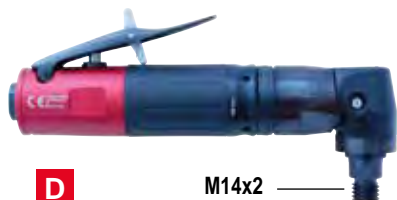
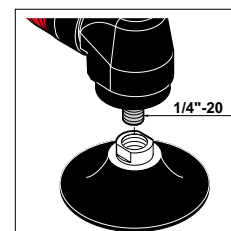

D

M14x2



E

CNOMO collet, Ø 6mm

Caution: comply with the speeds recommended by component and abrasive manufacturers.

PIC REF	MODEL	PART NUMBER	FREE SPEED rpm	ABRASIVE OR COLLET MAX CAPACITY		THREADED SPINDLE	POWER		WEIGHT		AIR CONSUMPTION				AIR INLET THREAD		HOSE INT. Ø	
				ø mm	ø in.		W	hp	kg	lb.	l/s	cfm	l/s	cfm	in.	mm	in.	
A	KA320EG	615 170 048 0	20000	76	3	1/4-20	375	0.5	0.67	1.47	6.5	13.5	10	21	1/4	8	5/16	
A	KA312EG	615 170 040 0	12000	76	3	1/4-20	375	0.5	0.67	1.47	3.0	6.5	9	19	1/4	8	5/16	
B	KA320G	615 170 044 0	20000	76	3	1/4-20	375	0.5	0.50	1.10	6.5	13.5	10	21	1/4	8	5/16	
B	KA318G	615 170 310 0	18000	76	3	1/4-20	375	0.5	0.50	1.10	3.0	6.5	9	19	1/4	8	5/16	
B	KA312G	615 170 038 0	12000	76	3	1/4-20	375	0.5	0.50	1.10	3.0	6.5	9	19	1/4	8	5/16	
B	KA309G	615 170 204 0	9000	76	3	1/4-20	220	0.3	0.50	1.10	2.2	4.7	8	17	1/4	8	5/16	
C	KA309C	615 170 203 0	9000	76	3	3/8-24	220	0.3	0.50	1.10	2.2	4.7	8	17	1/4	8	5/16	

LOW SPEED SANDERS

D	KA3.36A	615 170 525 0	3600	-	-	M14x2	300	0.4	0.70	1.54	9.5	20.0	-	-	1/4	6	1/4
E	KA3.36-7	615 170 523 0	3600	cap. 8mm (5/16")	-	-	300	0.4	0.70	1.54	9.5	20.0	-	-	1/4	6	1/4
E	KA3.21-7	615 170 524 0	2100	cap. 8mm (5/16")	-	-	300	0.4	0.70	1.54	9.5	20.0	-	-	1/4	6	1/4

1/4"-20 UNC - 3/8"-24 UNF

Accessories

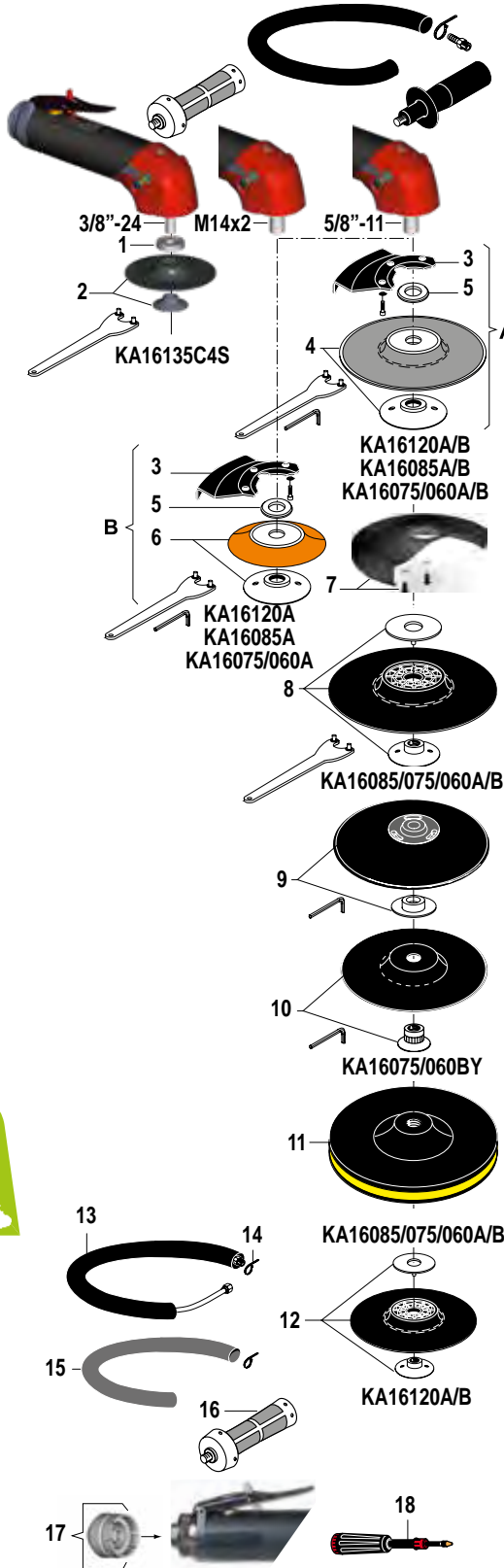
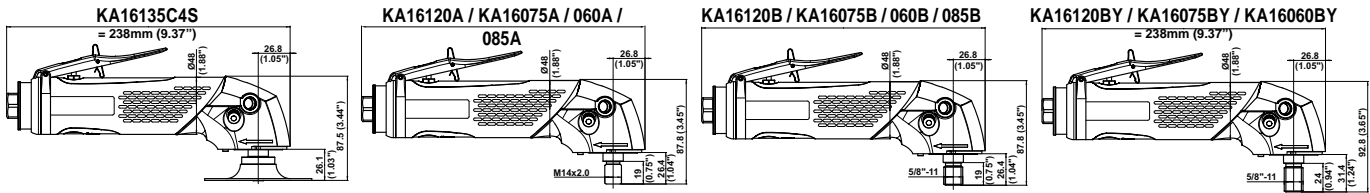

KA16135C4S / KA16120/075/060A-B-BY / KA16085A-B

ACCESSORIES INCLUDED

ITEM	KA16135C4S 3/8"-24	KA16120	KA16085 KA16075/060
• Exhaust hose L= 1.5m (60")	615 875 113 0	615 875 113 0	615 875 113 0
• Clamp	615 263 024 0	615 263 024 0	615 263 024 0
• 3/8" air hose nipple for 13mm ID hose	615 704 027 0	615 704 027 0	615 704 027 0
• Side handle			615 576 038 0
• Flat wrench, 17mm (1-1/16")	615 801 032 0	615 801 032 0	615 801 032 0
• Vibration-damping side handle	615 576 066 0	615 576 066 0	
1 Flange	615 606 515 0		
2 Backing with nut	615 990 167 0		
• Pin wrench, 20-3mm	615 802 008 0		

OPTIONAL ACCESSORIES

SANDING WITH STANDARD ABRASIVE DISC Ø 127MM (5")		KA16120A KA16085/075/060A M14x2	KA16120B KA16085/075/060B 5/8"-11
ITEM			
A Sanding kit for abrasive disc (including items 4-5)		615 396 072 0	615 396 072 0
3 Finger guard		615 504 145 0	615 504 145 0
4 Ventilated backing pad with nut M14 & 5/8" (max. 12.000 rpm)		615 990 127 0	615 990 127 0
• Pin wrench, 35mm (1-3/8")		615 802 010 0	615 802 010 0
• Hex key 8mm (5/16")		615 802 061 0	615 802 061 0
5 M14 Spacer		615 641 027 0	
5 5/8" Spacer			615 642 050 0

SANDING WITH SEMIRIGID DISC Ø 127MM (5")		KA16120A KA16085/075/060A M14X2
ITEM		
B Sanding kit for semirigid disc (including items 5-6)		615 396 075 0
3 Finger guard		615 504 145 0
6 Backing pad with nut M14 (max. 12.000 rpm)		615 990 129 0*
• Pin wrench, 35mm (1-3/8")		615 802 010 0
• Hex key 8mm (5/16")		615 802 061 0
5 M14 Spacer		615 641 027 0

SANDING	KA16085/075/060A M14x2	KA16085/075/060B 5/8"-11	KA16075/060BY 5/8"-11
ITEM			
7 Sanding guard ø 180mm (7")	615 504 205 0*	615 504 205 0*	615 504 205 0*
8 Soft backing pad with nut M14 & 5/8" ø 180mm (7") (max. 8500 rpm)	615 990 133 0*	615 990 133 0*	
8 Rigid backing pad with nut M14 & 5/8" ø 180mm (7") (max. 8.500 rpm)	615 990 134 0*	615 990 134 0*	
• Pin wrench 35mm (1-3/8")	615 802 010 0	615 802 010 0	
9 Spiracool pad whit nut ø 180mm (7") (max.8500 rpm)			S091836
10 Complete kit ø 180mm (7") (max.7000 rpm) for KA16060BY			K129587
• Hex key 8mm (5/16")			615 802 061 0
11 Rigid velcro-backed backing pad ø 180mm (7") (max.8700 rpm)		615 990 146 0	
11 Rigid velcro-backed backing pad ø 150mm (6") (max.10000 rpm)		615 990 138 0	

* Spare part: Nut 606.22 for M14 model and 608.29 for 5/8"-11

OTHER OPTIONAL ACCESSORIES

ITEM	PART NO.
12 Semi-hard backing pad with nut M14 & 5/8" - ø 127mm (5") (max. 12.000 rpm)	615 804 074 0
13 Complete silencer kit	615 396 166 0
14 Clamp	615 263 024 0
15 Reinforced cloth-lined exhaust hose L = 0.75m (30")	615 875 116 0
16 Vibration-damping side handle	615 576 066 0
17 Clippable silencer	615 396 957 0
18 Grease gun includes 24g (0.8 oz)	615 990 149 0
• Grease for bevel gear (1 kg -2.2 lb)	615 990 148 0

Sanders for abrasive discs

Ø 100mm (4") - Ø 127mm (5") - Ø 150mm (6")
Ø 180mm (7")

1350 to 1700 Watts (1.83 to 2.3 hp) - 6000 to 13500 rpm

Supplied with M14 or 5/8" threaded spindle only



A



B



C D



C D



Caution: comply with the speeds recommended by component and abrasive manufacturers.

PIC REF	MODEL	PART NUMBER	FREE SPEED	THREADED SPINDLE	POWER		WEIGHT		AIR CONSUMPTION				AIR INLET THREAD		HOSE INT. Ø	
					W	hp	kg	lb.	AT FREE SPEED		AT MAX. SPEED		in.	mm	in.	mm
			rpm	in.					l/s	cfm	l/s	cfm				
A	KA16135C4S	615 170 446 0	13500	3/8-24	1 700	2.28	1.48	3.3	25	53	35	74	3/8	13	1/2	
B	KA16120A	615 170 435 0	12000	M14x2	1 700	2.28	1.39	3.0	20	42	32	68	3/8	13	1/2	
B	KA16120B	615 170 445 0	12000	5/8-11	1 700	2.28	1.39	3.0	20	42	32	68	3/8	13	1/2	
C/D	KA16085A	615 170 468 0	8500	M14x2	1 700	2.28	1.39	3.0	20	42	32	68	3/8	13	1/2	
C/D	KA16085B	615 170 469 0	8500	5/8-11	1 700	2.28	1.39	3.0	20	42	32	68	3/8	13	1/2	
C/D	KA16075A	615 170 448 0	7500	M14x2	1 500	2.01	1.39	3.0	15	32	27	57	3/8	13	1/2	
C/D	KA16075B	615 170 452 0	7500	5/8-11	1 500	2.01	1.39	3.0	15	32	27	57	3/8	13	1/2	
C/D	KA16060A	615 170 449 0	6000	M14x2	1 350	1.81	1.41	3.1	11	23	23	49	3/8	13	1/2	
C/D	KA16060B	615 170 453 0	6000	5/8-11	1 350	1.81	1.41	3.1	11	23	23	49	3/8	13	1/2	
For USA Market only (to ANSI B186.1)																
B	KA16120BY	615 170 447 0	12000	5/8-11	1 700	2.28	1.41	3.1	20	42	32	68	3/8	13	1/2	
D	KA16075BY	615 170 450 0	7500	5/8-11	1 500	2.01	1.41	3.1	15	32	27	57	3/8	13	1/2	
D	KA16060BY	615 170 451 0	6000	5/8-11	1 350	1.81	1.41	3.1	11	23	23	49	3/8	13	1/2	

3/8"-24 UNF - 5/8"-11 UNC

Accessories

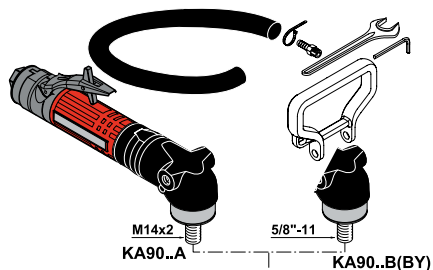
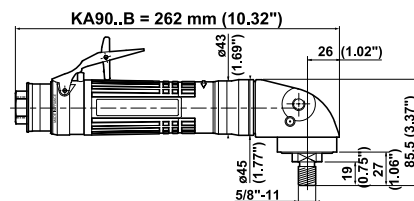
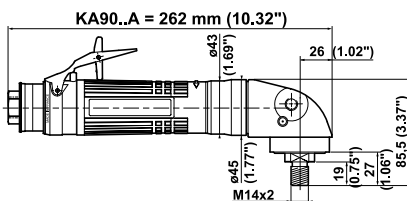
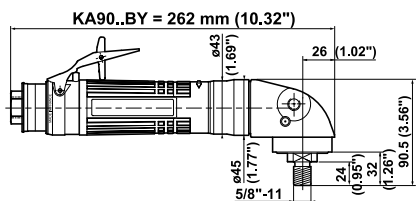

KA90..A / KA90..B / KA90..BY

ACCESSORIES INCLUDED

	PART NO.
• Exhaust hose L = 1.5m (60")	615 875 113 0
• Clamp	615 873 415 0
• 3/8" air hose nipple for 10mm (3/8") ID hose	615 704 017 0
• Support handle	615 576 069 0
• Flat wrench, 17mm (1-1/16")	615 801 032 0
• Hex key 8mm (5/16")	615 802 061 0

OPTIONAL ACCESSORIES

SANDING		KA90..A	KA90..B	KA9030/20BY
ITEM		M14x2	5/8"-11	5/8"-11
1	Soft backing pad with nut M14 & 5/8" ϕ 180mm (7") (max. 8500 rpm)	615 990 133 0	615 990 133 0	
1	Rigid backing pad with nut M14 & 5/8" ϕ 180mm (7") (max. 8500 rpm)	615 990 134 0	615 990 134 0	
	• Pin wrench, 35mm (1-3/8")	615 802 010 0	615 802 010 0	
2	Rigid velcro-backed backing pad ϕ 180mm (7") (max. 8700 rpm)		615 990 146 0	
2	Rigid velcro-backed backing pad ϕ 150mm (6") (max. 10000 rpm)		615 990 138 0	
3	Spiracool pad with nut ϕ 180mm (7") (max. 8500 rpm)			S091836
3	Spiracool pad with nut ϕ 230mm (9") (max. 6500 rpm)			S091839
4	Complete Kit ϕ 180mm (7") (max. 7000 rpm)			K129587
	• Hex. Key 8mm (5/16")			615 802 061 0
POLISHING				KA90..A
ITEM				KA90..B
5	Soft backing pad with nut M14 & 5/8" ϕ 180mm (7") (max. 8500 rpm)			615 990 133 0
	• Pin wrench 35mm (1-3/8")			615 802 010 0
6	Sheepskin ϕ 180mm (7") (max. 2100 rpm)			615 845 999 0

OTHER OPTIONAL ACCESSORIES

ITEM		PART NO.
7	Complete silencer kit	615 396 166 0
8	Clamp	615 873 115 0
9	Reinforced cloth-lined exhaust hose L = 0.75m (30")	615 875 116 0
10	Vibration-damping side handle	615 576 066 0
11	Side handle	615 576 038 0
12	Clippable silencer	615 396 655 0

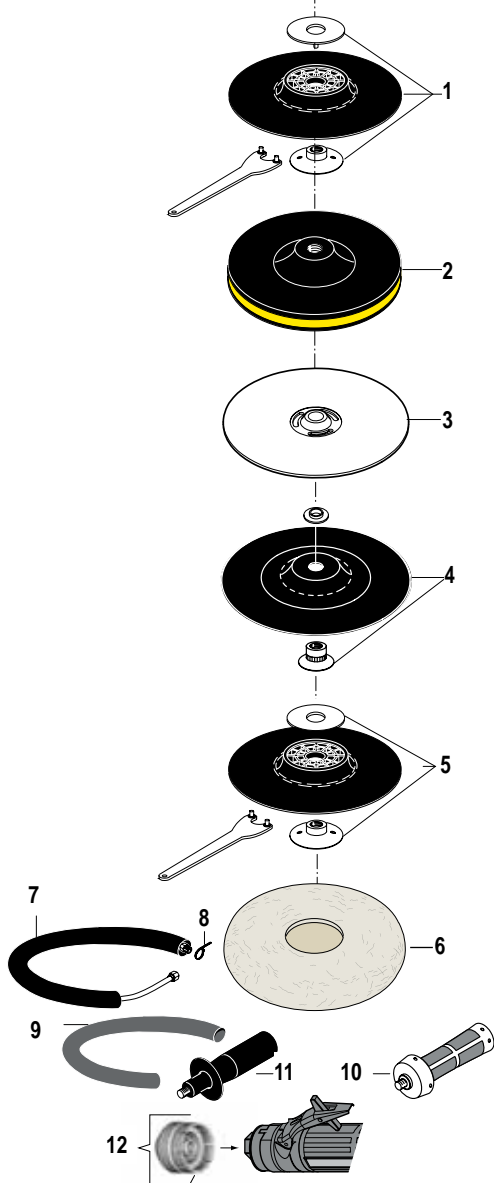

Sanders for abrasive discs polishing Ø 150mm (6") - Ø 180mm (7") - Ø 230mm (9")

900 Watts (1.21 hp) - 2000 and 3000 rpm

Supplied with M14 or 5/8" threaded spindle only



Caution: comply with the speeds recommended by component and abrasive manufacturers.

PIC REF	MODEL	PART NUMBER	FREE SPEED	THREADED SPINDLE	POWER		WEIGHT		AIR CONSUMPTION				AIR INLET THREAD	HOSE INT. Ø	
					rpm	in.	W	hp	kg	lb.	AT FREE SPEED	AT MAX OUTPUT		in.	mm
A	KA9030A	615 170 098 0	3000	M14x2	900	1.21	1.6	3.5	13	27	17	36	3/8	10	3/8
A	KA9030B	615 170 099 0	3000	5/8-11	900	1.21	1.6	3.5	13	27	17	36	3/8	10	3/8
A	KA9020A	615 170 096 0	2000	M14x2	900	1.21	1.6	3.5	7	15	17	36	3/8	10	3/8
A	KA9020B	615 170 097 0	2000	5/8-11	900	1.21	1.6	3.5	7	15	17	36	3/8	10	3/8

For USA Market only (to ANSI B186.1)

A	KA9030BY	615 170 309 0	3000	5/8-11	900	1.21	1.6	3.5	13	27	17	36	3/8	10	3/8
---	----------	---------------	------	--------	-----	------	-----	-----	----	----	----	----	-----	----	-----

5/8"-11 UNC

Accessories

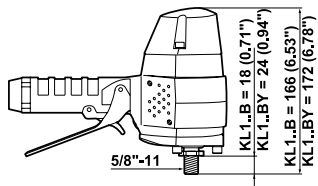

KA26065BV / 085BV = 334mm (13.15")

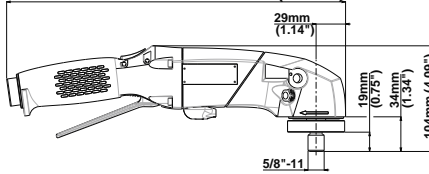

KA26060BY / 077BY = 334mm (13.15")

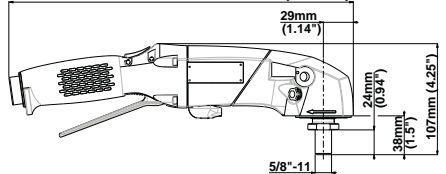

KL165B / KA26085BV / KA26065BV / KA26077BY / KA26060BY

ACCESSORIES INCLUDED

	KL165B	KA26085BV KA26065BV	KA26077BY KA26060BY
• Rear flange	615 503 107 0		615 503 107 0
• Auto-balancer		615 990 195 0	
• Rotating handle support kit		615 397 741 5	615 397 741 5
• Rotating exhaust kit		615 397 743 5	615 397 743 5
• 1/2" air hose nipple for 13mm (1/2") ID hose	615 704 016 0		
• 1/2" air hose nipple for 15mm (5/8") ID hose		615 704 014 0	615 704 014 0
• Vibration-damping side handle		615 576 066 0	615 576 066 0

OPTIONAL ACCESSORIES

SANDING WITH STANDARD ABRASIVE DISC Ø 180MM (7")		KL165B	KA26085BV KA26077BY
ITEM			
• Rear flange for KA26085BV			615 503 107 0
1 Soft Backing pad with nut 5/8", ø 180mm (7") - (max. 8500 rpm)		615 990 133 0*	615 990 133 0*
• Pin wrench, 35mm (1-3/8")		615 802 010 0	615 802 010 0
• Hex key 8mm (5/16")		615 802 061 0	

*Spare Part: Nut 615 608 047 0

SANDING WITH SPIRACOO PAD Ø 180MM (7")			KA26077BY
ITEM			
A Spiracool pad with nut 5/8", ø 180mm (7") - (Max. 8500 rpm)			S091836
• Pin wrench 35mm (1-3/8")			615 802 010 0

SANDING WITH STANDARD ABRASIVE DISC Ø 230MM (9")			KA26065BV KA26060BY
ITEM			
• Rear flange for KA26065BV			615 503 107 0
2 Soft Backing pad with nut 5/8", ø 230mm (9") - (max. 6500 rpm)			615 990 141 0
• Pin wrench, 35mm (1-3/8")			615 802 010 0
• Hex key 8mm (5/16")			615 802 061 0

* Spare Part: Nut 608.29

OTHER OPTIONAL ACCESSORIES

ITEM	KL165B	KA26..
3 Rigid backing pad with nut 5/8", ø 180mm (7") - (max. 8500 rpm)	615 990 134 0	
4 Silencer kit	615 399 462 0	
5 Grease gun includes 24g (0.8 oz)		615 990 149 0
• Grease for bevel gear (1kg - 2.2 lb)		615 990 148 0

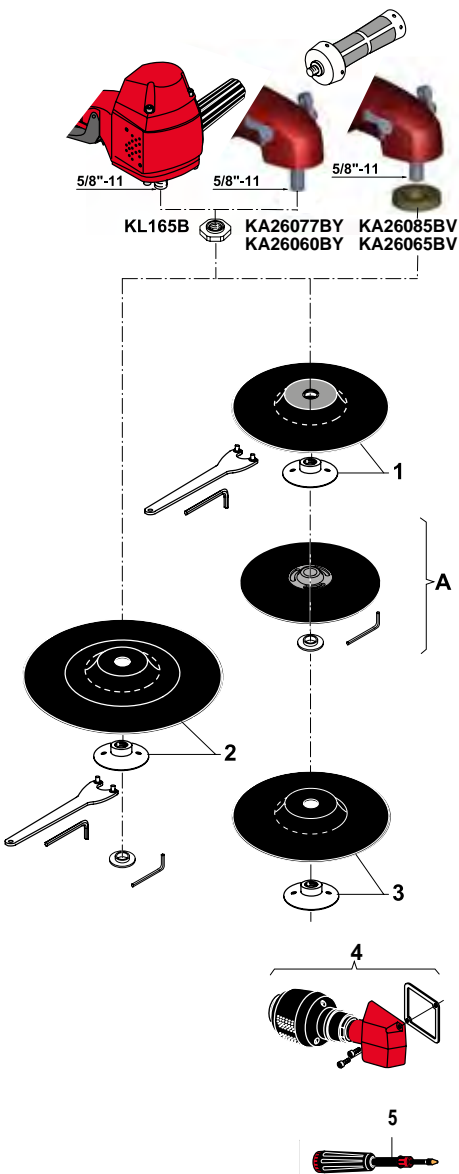

Sanders for abrasive discs Ø 180mm (7") - Ø 230mm (9")

1200 and 2100 Watts (1.61 and 2.82 hp) - 6000 to 8500 rpm

Supplied with 5/8" threaded spindle only



A



B



C

Caution: comply with the speeds recommended by component and abrasive manufacturers.

PIC REF	MODEL	PART NUMBER	FREE SPEED	ABRASIVE MAX CAPACITY		THREADED SPINDLE	POWER		WEIGHT		AIR CONSUMPTION				AIR INLET THREAD		HOSE INT. Ø	
				Ø mm	Ø in.		W	hp	kg	lb.	AT FREE SPEED	AT MAX SPEED	AT FREE SPEED	AT MAX SPEED	in.	mm	in.	

VERTICAL SANDER

A	KL165B	615 170 011 0	6500	180	7	5/8-11	1200	1.61	2.3	5.1	6	13	25	53	1/2	13	1/2
---	--------	---------------	------	-----	---	--------	------	------	-----	-----	---	----	----	----	-----	----	-----

ANGLE SANDERS

B	KA26085BV	615 170 479 0	8500	180	7	5/8-11	2100	2.82	2.3	5.1	17	36	36	77	1/2	15	5/8
B	KA26065BV	615 170 480 0	6500	180-230	7-9	5/8-11	2100	2.82	2.3	5.1	21	44	38	80	1/2	15	5/8

ANGLE SANDERS

For USA Market only (to ANSI B186.1)

C	KA26077BY	615 170 481 0	7700	180	7	5/8-11	2100	2.82	2.3	5.1	16	33	32	69	1/2	15	5/8
C	KA26060BY	615 170 482 0	6000	180-230	7-9	5/8-11	2100	2.82	2.3	5.1	18	38	37	77	1/2	15	5/8

5/8"-11 UNC

Accessories

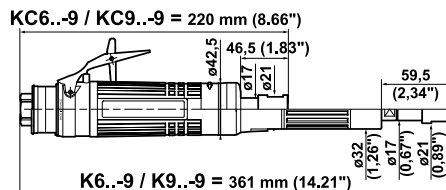
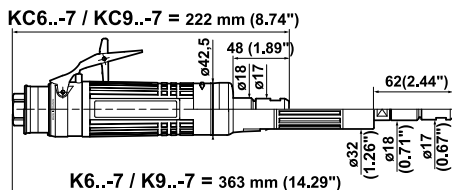

K6..- / K9..- / KC6..- / KC9..-

ACCESSORIES INCLUDED

ITEM		COLLET CNOMO	COLLET SERIES 200
1	CNOMO collet ø 6mm	615 526 049 0	
2	Series 200 resilient collet, ø 5.55 to 6.35mm (1/4")		615 526 063 0
	• Exhaust hose L = 1.5m (60")	615 875 113 0	615 875 113 0
	• Clamp	615 873 415 0	615 873 415 0
	• 3/8" air hose nipple for 10mm (3/8") ID hose	615 704 017 0	615 704 017 0
	• Flat wrench 14mm	615 801 005 0	615 801 005 0
	• Flat wrench 19mm (3/4")		615 801 076 0

OPTIONAL ACCESSORIES

ITEM		K6../K9..-	KC6../KC9..
3	Suction cap		615 396 013 0
4	Suction cap		615 396 023 0
5	Suction cap	615 396 014 0	

OTHER OPTIONAL ACCESSORIES

ITEM		PART NO.
6	Complete silencer kit	615 396 166 0
7	Clamp	615 873 115 0
8	Reinforced cloth-lined exhaust hose L = 0.75m (30")	615 875 116 0
9	Clippable silencer	615 396 655 0

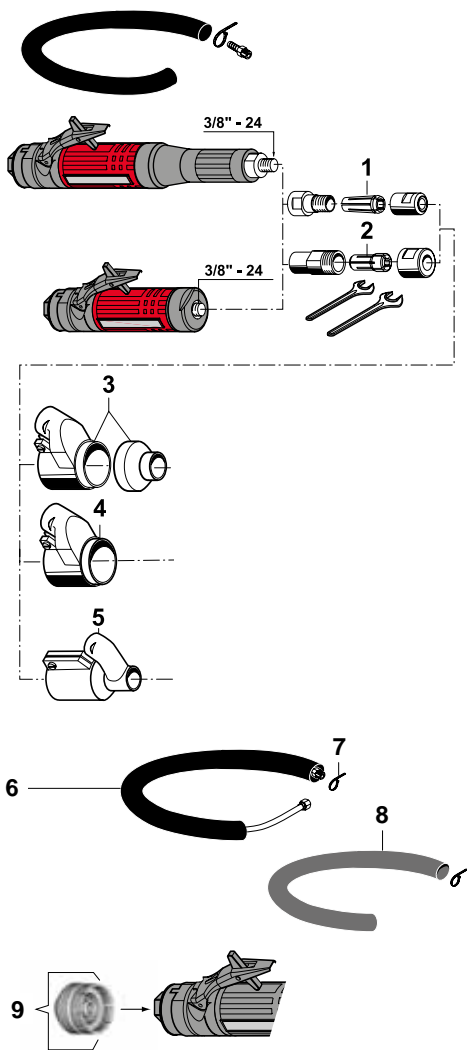

Dust extraction systems for straight grinders

600 and 900 Watts (0.8 and 1.21 hp) - 12000 to 28000 rpm



A



B



B



615 396 014 0
Vacuum hose,
ID 25mm
(1")



615 396 013 0
Vacuum hose,
ID 32mm
(1-1/4")



615 396 023 0
Vacuum hose,
ID 32mm
(1-1/4")

Caution: comply with the speeds recommended by component and abrasive manufacturers.

PIC REF	MODEL	PART NUMBER			SUCTION CAP ASSEMBLY	FREE SPEED	POWER		WEIGHT		AIR INLET THREAD
		CNOMO COLLET (-7)	SERIES 200 COLLET (-9)				W	hp	kg	lb.	
						rpm					in.
A	K628-	615 170 107 0	615 170 150 0	+	615 396 014 0	28000	600	0.80	1.3	2.9	3/8
A	K624-	615 170 106 0	615 170 151 0	+	615 396 014 0	24000	600	0.80	1.3	2.9	3/8
A	K922-	615 170 119 0	615 170 152 0	+	615 396 014 0	22000	900	1.21	1.4	3.1	3/8
A	K619-	615 170 105 0	615 170 153 0	+	615 396 014 0	19000	600	0.80	1.3	2.9	3/8
A	K918-	615 170 117 0	615 170 154 0	+	615 396 014 0	18000	900	1.21	1.4	3.1	3/8
A	K615-	615 170 104 0	615 170 155 0	+	615 396 014 0	15000	600	0.80	1.3	2.9	3/8
A	K915-	615 170 114 0	615 170 156 0	+	615 396 014 0	15000	900	1.21	1.4	3.1	3/8
A	K912-	615 170 110 0	615 170 157 0	+	615 396 014 0	12000	900	1.21	1.4	3.1	3/8
B	KC628-	615 170 126 0	615 170 158 0	+	615 396 013 0 or 615 396 023 0	28000	600	0.80	0.9	2.0	3/8
B	KC624-	615 170 125 0	615 170 159 0	+	615 396 013 0 or 615 396 023 0	24000	600	0.80	0.9	2.0	3/8
B	KC922-	615 170 130 0	615 170 160 0	+	615 396 013 0 or 615 396 023 0	22000	900	1.21	1.0	2.2	3/8
B	KC619-	615 170 124 0	615 170 161 0	+	615 396 013 0 or 615 396 023 0	19000	600	0.80	0.9	2.0	3/8
B	KC918-	615 170 129 0	615 170 162 0	+	615 396 013 0 or 615 396 023 0	18000	900	1.21	1.0	2.2	3/8
B	KC615-	615 170 123 0	615 170 163 0	+	615 396 013 0 or 615 396 023 0	15000	600	0.80	0.9	2.0	3/8
B	KC915-	615 170 128 0	615 170 164 0	+	615 396 013 0 or 615 396 023 0	15000	900	1.21	1.0	2.2	3/8
B	KC912-	615 170 127 0	615 170 165 0	+	615 396 013 0 or 615 396 023 0	12000	900	1.21	1.0	2.2	3/8

Accessories

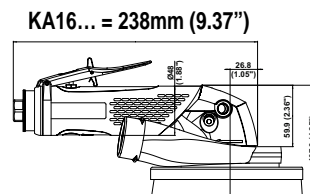
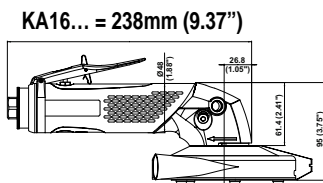

KA16120. / KA16085. / KA16075. / KA16060.

ACCESSORIES INCLUDED

	PART NO.
• Exhaust hose L = 1.5m (60")	615 875 113 0
• Clamp	615 263 024 0
• 3/8" air hose nipple for 13mm (1/2") ID hose	615 704 027 0
• Side handle	615 576 038 0
• Flat wrench, 17mm (1-1/16")	615 801 032 0

OPTIONAL ACCESSORIES

FOR COMPOSITE CUTTING		KA16120 / KA16085. KA16075. / KA16060
ITEM		Ø 127mm (5")
A	Dust extraction Kit for Diamond disc Ø 127mm (5")	615 397 830 0
1	Manifold cutting with screws	615 504 217 0
2	Goble cover plate complete	615 504 218 0
3	Flange nut M14	615 606 046 0
3	Flange nut 5/8"	615 606 045 0
	• Pin key	615 802 067 0

DUST EXTRACTION FOR COMPOSITE, NON METAL SANDING		KA16120 / KA16085. KA16075. / KA16060	KA16085. KA16075. / KA16060
ITEM		Ø 127mm (5")	Ø 180mm (7")
B	Dust extraction Kit for disc Ø 127mm (5")	615 397 828 0	
C	Dust extraction Kit for disc Ø 180mm (7")		615 397 829 0
4	Suction cap	615 504 194 0	615 504 194 0
5	Skirt with brush	615 570 234 0	615 570 231 0
6	Ventilated backing pad Ø127mm (5") with nut M14 & 5/8" (max. 12000 rpm)	615 990 199 0	
7	Rigid backing pad Ø180mm (7") with nut M14 & 5/8" (max. 8500 rpm)		615 990 198 0
	• Pin wrench, 35mm (1-3/8")	615 802 010 0	615 802 010 0

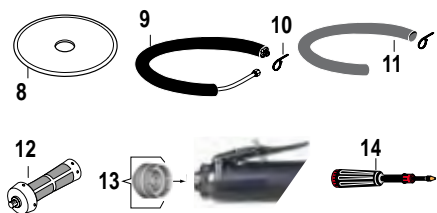
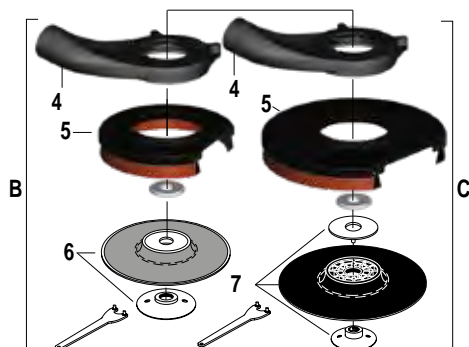
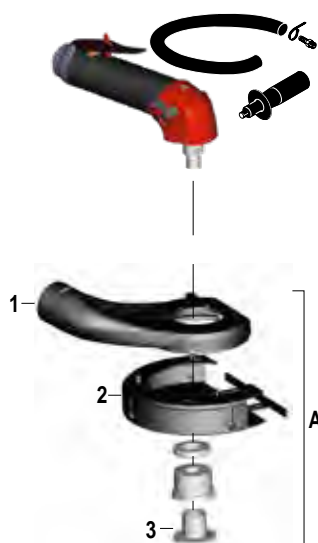

OTHER OPTIONAL ACCESSORIES

ITEM	PART NO.	
8	Diamond disc Ø 127mm (5")	615 804 915 0
9	Complete silencer kit	615 396 166 0
10	Clamp	615 263 024 0
11	Reinforced cloth-lined exhaust hose L = 0.75m (30")	615 875 116 0
12	Vibration-damping side handle	615 576 066 0
13	Clippable silencer	615 396 957 0
14	Grease gun includes 24g (0.8oz)	615 990 149 0
	• Grease for bevel gear (1 kg - 2.2 lb)	615 990 148 0

Dust extraction systems for angle models Ø 127mm (5") - Ø 180mm (7")

1350 to 1700 Watts (1.81 to 2.28 hp) - 6000 to 12000 rpm



A

Dust extraction casing for diamond disc Ø 127mm (5")
Vacuum hose ID 25mm (1")

B

Vacuum hose, ID 38mm (1-1/2")



B/C

Vacuum hose, ID 38mm (1-1/2")



Caution: comply with the speeds recommended by component and abrasive manufacturers.

PIC REF	MODEL	PART NUMBER	DUST EXTRACTION KIT		FREE SPEED rpm	THREADED SPINDLE	POWER		WEIGHT		AIR INLET THREAD
			Ø 127mm (5")	Ø 180mm (7")			W	hp	kg	lb.	

CUTTING Ø 127mm (5") - M14 Output

A	KA16120A	615 170 435 0	+	615 397 830 0	12000	M14x2	1700	2.28	1.39	3.0	3/8
A	KA16085A	615 170 468 0	+	615 397 830 0	8500	M14x2	1700	2.28	1.39	3.0	3/8
A	KA16075A	615 170 448 0	+	615 397 830 0	7500	M14x2	1500	2.01	1.39	3.0	3/8
A	KA16060A	615 170 449 0	+	615 397 830 0	6000	M14x2	1350	1.81	1.41	3.1	3/8

CUTTING Ø 127mm (5") - 5/8" Output

A	KA16120B	615 170 445 0	+	615 397 830 0	12000	5/8-11	1700	2.28	1.98	4.4	3/8
A	KA16085B	615 170 469 0	+	615 397 830 0	8500	5/8-11	1700	2.28	1.39	3.0	3/8
A	KA16075B	615 170 452 0	+	615 397 830 0	7500	5/8-11	1500	2.01	1.39	3.0	3/8
A	KA16060B	615 170 453 0	+	615 397 830 0	6000	5/8-11	1350	1.81	1.41	3.1	3/8

CUTTING Ø 127mm (5") - 5/8" Output for USA Market only (to ANSI B186.1)

A	KA16120BY	615 170 447 0	+	615 397 830 0	12000	5/8-11	1700	2.28	1.98	4.4	3/8
A	KA16075BY	615 170 450 0	+	615 397 830 0	7500	5/8-11	1500	2.01	1.39	3.0	3/8
A	KA16060BY	615 170 451 0	+	615 397 830 0	6000	5/8-11	1350	1.81	1.41	3.1	3/8

SANDING Ø 127 mm (5") & Ø 180 mm (7") - M14 & 5/8" Output

B	KA16120A	615 170 435 0	+	615 397 828 0	12000	M14x2	1700	2.28	1.39	3.0	3/8	
B	KA16120B	615 170 445 0	+	615 397 828 0	12000	5/8-11	1700	2.28	1.39	3.0	3/8	
B/C	KA16085A	615 170 468 0	+	615 397 828 0	615 397 829 0	8500	M14x2	1700	2.28	1.39	3.0	3/8
B/C	KA16085B	615 170 469 0	+	615 397 828 0	615 397 829 0	8500	5/8-11	1700	2.28	1.39	3.0	3/8
B/C	KA16075A	615 170 448 0	+	615 397 828 0	615 397 829 0	7500	M14x2	1500	2.01	1.39	3.0	3/8
B/C	KA16075B	615 170 452 0	+	615 397 828 0	615 397 829 0	7500	5/8-11	1500	2.01	1.39	3.0	3/8
B/C	KA16060A	615 170 449 0	+	615 397 828 0	615 397 829 0	6000	M14x2	1350	1.81	1.41	3.1	3/8
B/C	KA16060B	615 170 453 0	+	615 397 828 0	615 397 829 0	6000	5/8-11	1350	1.81	1.41	3.1	3/8

5/8"-11 UNC

Accessories

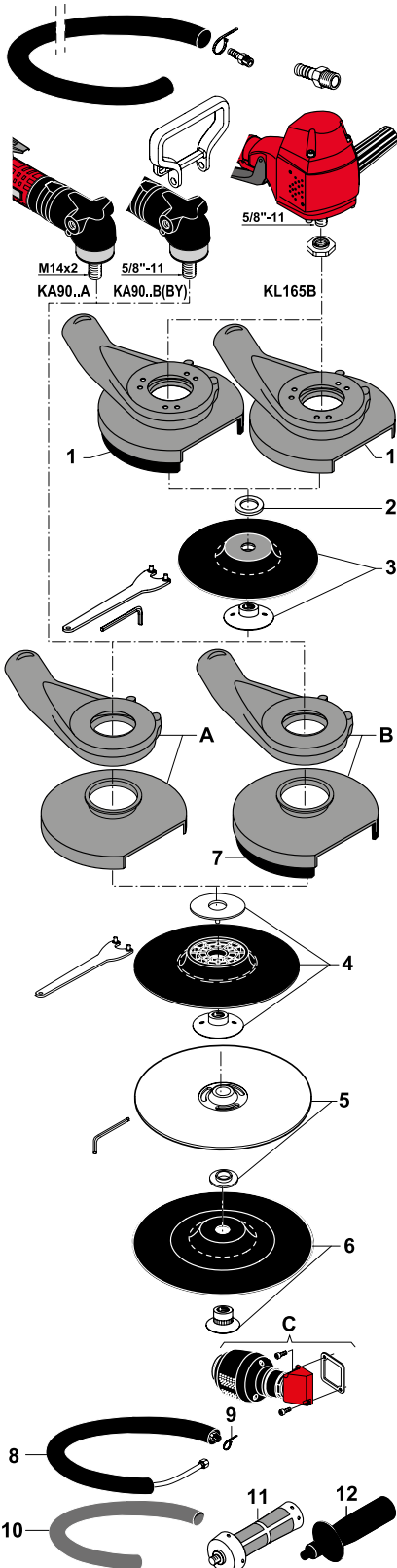
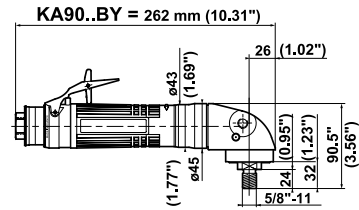
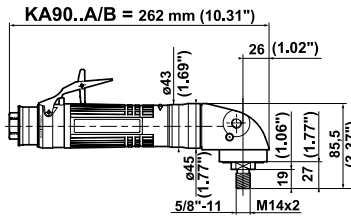
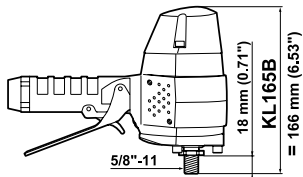

KL165B / KA90.. A / KA90..B / KA90..BY

ACCESSORIES INCLUDED

	KL165B	KA90..A KA90..B / BY
• Rear flange	615 503 107 0	
• 1/2" air hose nipple for 13mm (1/2") ID hose	615 704 016 0	
• Exhaust hose L= 1.5m (60")		615 875 113 0
• Clamp		615 873 415 0
• 3/8" air hose nipple for 10mm (3/8") ID hose		615 704 017 0
• Support handle		615 576 069 0

OPTIONAL ACCESSORIES

FOR SANDING MATERIALS ITEM	KL165B non metallic Fibre disc Ø 180mm (7")	KL165B metallic Fibre disc Ø 180mm (7")
• Complete kit (including item 1-2-3)	615 399 364 0	615 399 365 0
1 Suction cap	615 399 359 0	615 399 360 0
2 Washer Z16U	615 642 050 0	615 642 050 0
3 Rigid backing pad Ø 180mm (7") with nut 5/8" (Max. 8500 rpm)	615 990 134 0	615 990 134 0
• Pin wrench, 35mm (1-3/8")	615 802 010 0	615 802 010 0
• Hex key 8mm (5/16")	615 802 061 0	615 802 061 0

FOR SANDING METALLIC MATERIALS ITEM	KA90..A / B Ø 180mm (7")	KA90..BY Ø 180mm (7")
A Suction cap	615 396 125 0	615 396 125 0
4 Rigid backing pad Ø 180mm (7") with nut M14 & 5/8" (Max. 8500 rpm)	615 990 134 0	
• Pin wrench, 35mm (1-3/8")	615 802 010 0	
5 Spiracool pad (Max. 8500 rpm)		S091836
6 Complete kit (Max. 7000 rpm)		K129587
• Hex key 8mm (5/16")		615 802 061 0

FOR SANDING NON METALLIC MATERIALS ITEM	KA90..A / B Ø 180mm (7")	KA90..BY Ø 180mm (7")
B Suction cap (including item 6-7)	615 396 126 0	615 396 126 0
4 Rigid backing pad Ø 180mm (7") with nut M14 & 5/8" (Max. 8500 rpm)	615 990 134 0	
7 Spare brush	615 570 233 0	
• Pin wrench, 35mm (1-3/8")	615 802 010 0	
5 Spiracool pad (Max. 8500 rpm)		S091836
6 Complete kit (Max. 7000 rpm)		K129587
• Hex key 8mm (5/16")		615 802 061 0

OTHER OPTIONAL ACCESSORIES

ITEM	KL165B	KA90..A KA90..B / BY
C Silencer kit	615 399 462 0	
8 Complete silencer kit		615 396 166 0
9 Clamp		615 873 115 0
10 Reinforced cloth-lined exhaust hose L = 0.75m (30")		615 875 116 0
11 Vibration-damping side handle		615 576 066 0
12 Side handle		615 576 038 0
13 Clippable silencer		615 396 655 0



Dust extraction systems for vertical and angle sanders

Ø 180mm (7")

900 and 1200 Watts (1.21 and 1.61 hp) - 2000 to 6500 rpm

Supplied with M14 & 5/8" threaded spindle only



A



B

For standard abrasive disc for non metallic materials

KL165

KA90..

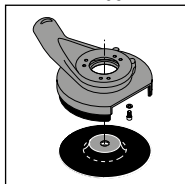

615 399 364 0

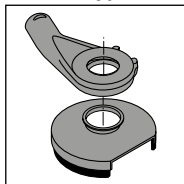

615 396 126 0

For standard abrasive disc for metallic materials

KL165

KA90..

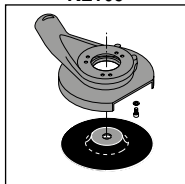

615 399 365 0

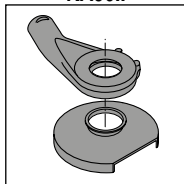

615 396 125 0

Vacuum hose, ID 38mm (1-1/2")



C

Caution: comply with the speeds recommended by component and abrasive manufacturers.

PIC REF	MODEL	PART NUMBER		DUST EXTRACTION KIT	FREE SPEED	THREADED SPINDLE	POWER		WEIGHT		AIR INLET THREAD
							W	hp	kg	lb.	
				Ø 180 mm (7")	rpm	in					in.

VERTICAL SANDER

A	KL165B	615 170 011 0	+	615 399 364 0 or 615 399 365 0	6500	5/8-11	1 200	1.61	2.3	5.1	1/2
---	--------	---------------	---	--------------------------------	------	--------	-------	------	-----	-----	-----

ANGLE SANDERS

B	KA9030A	615 170 098 0	+	615 396 126 0 or 615 396 125 0	3000	M14x2	900	1.21	1.6	3.5	3/8
B	KA9030B	615 170 099 0	+	615 396 126 0 or 615 396 125 0	3000	5/8-11	900	1.21	1.6	3.5	3/8
B	KA9020A	615 170 096 0	+	615 396 126 0 or 615 396 125 0	2000	M14x2	900	1.21	1.6	3.5	3/8
B	KA9020B	615 170 097 0	+	615 396 126 0 or 615 396 125 0	2000	5/8-11	900	1.21	1.6	3.5	3/8

ANGLE SANDER for USA Market Only (to Ansi B186.1)

C	KA9030BY	615 170 309 0	+	615 396 126 0 or 615 396 125 0	3000	5/8-11	900	1.21	1.6	3.5	3/8
---	----------	---------------	---	--------------------------------	------	--------	-----	------	-----	-----	-----

5/8"-11 UNC

Accessories

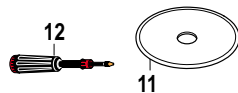
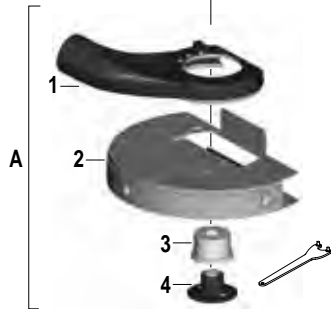
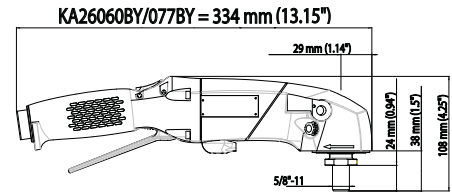
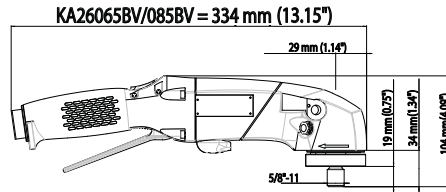

KA26085BV / KA26065BV / KA26077BY / KA26060BY

ACCESSORIES INCLUDED

	KA26085BV KA26065BV	KA26077BY KA26060BY
• Auto-balancer	615 990 195 0	
• Rear flange		615 503 107 0
• Rotating handle support kit	615 397 741 5	615 397 741 5
• Rotating exhaust kit	615 397 743 5	615 397 743 5
• Vibration-damping side handle	615 576 066 0	615 576 066 0

OPTIONAL ACCESSORIES

FOR COMPOSITE CUTTING	KA26085BV/065BV KA26077BY/060BY Ø 180mm (7")
A Dust extraction Kit for Diamond disc Ø 180mm (7")	615 397 844 0
1 Manifold cutting with screws	615 504 220 0
2 Goble cover plate complete	615 504 221 0
3 Spacer - hole 5/8"	615 643 090 0
4 Flange nut 5/8"	615 606 048 0
• Pin wrench, 35mm (1-3/8")	615 802 010 0
DUST EXTRACTION FOR COMPOSITE, NON METAL SANDING	KA26085BV/065BV KA26077BY/060BY Ø 180mm (7")
B Dust extraction Kit for disc Ø 180mm (7")	615 397 843 0
5 Manifold with screws	615 504 219 0
6 Skirt with brush	615 570 231 0
7 Spacer 9mm	615 643 093 0
8 Spacer 6mm - Hole 16mm (5/8")	615 643 091 0
9 Rigid backing pad Ø180mm (7") (max. 8500rpm)	615 990 200 0
10 Flange nut 5/8"	615 606 047 0
• Pin wrench, 35mm (1-3/8")	615 802 067 0

OTHER OPTIONAL ACCESSORIES

ITEM	PART NO.
11 Diamond disc Ø 180mm (7")	615 811 145 0
12 Grease gun includes 24g (0.8oz)	615 990 149 0
• Grease for bevel gear (1 kg - 2.2 lb)	615 990 148 0



Dust extraction systems for angle models

Ø 180mm (7")

2100 Watts (2.82 hp) - 6000 to 8500 rpm



A

Dust extraction casing for diamond disk Ø 180mm (7")
Vacuum hose, ID 38mm (1-1/2")



B

Vacuum hose, ID 38mm (1-1/2")

Caution: comply with the speeds recommended by component and abrasive manufacturers.

PIC REF	MODEL	PART NUMBER		DUST EXTRACTION KIT	FREE SPEED	THREADED SPINDLE	POWER		WEIGHT		AIR INLET THREAD
							W	hp	kg	lb	
CUTTING Ø 180mm (7")											
A	KA26085BV	615 170 479 0	+	615 397 844 0	8500	5/8-11	2100	2.82	2.3	5.1	1/2
A	KA26065BV	615 170 480 0	+	615 397 844 0	6500	5/8-11	2100	2.82	2.3	5.1	1/2
CUTTING Ø 180mm (7") for USA Market only (to ANSI B186.1)											
A	KA26077BY	615 170 482 0	+	615 397 844 0	7700	5/8-11	2100	2.82	2.3	5.1	1/2
A	KA26060BY	615 170 481 0	+	615 397 844 0	6000	5/8-11	2100	2.82	2.3	5.1	1/2
SANDING Ø 180mm (7")											
B	KA26085BV	615 170 479 0	+	615 397 843 0	8500	5/8-11	2100	2.82	2.3	5.1	1/2
B	KA26065BV	615 170 480 0	+	615 397 843 0	6500	5/8-11	2100	2.82	2.3	5.1	1/2
SANDING Ø 180mm (7") for USA Market only (to ANSI B186.1)											
B	KA26077BY	615 170 482 0	+	615 397 843 0	7700	5/8-11	2100	2.82	2.3	5.1	1/2
B	KA26060BY	615 170 481 0	+	615 397 843 0	6000	5/8-11	2100	2.82	2.3	5.1	1/2

5/8"-11 UNC

Accessories

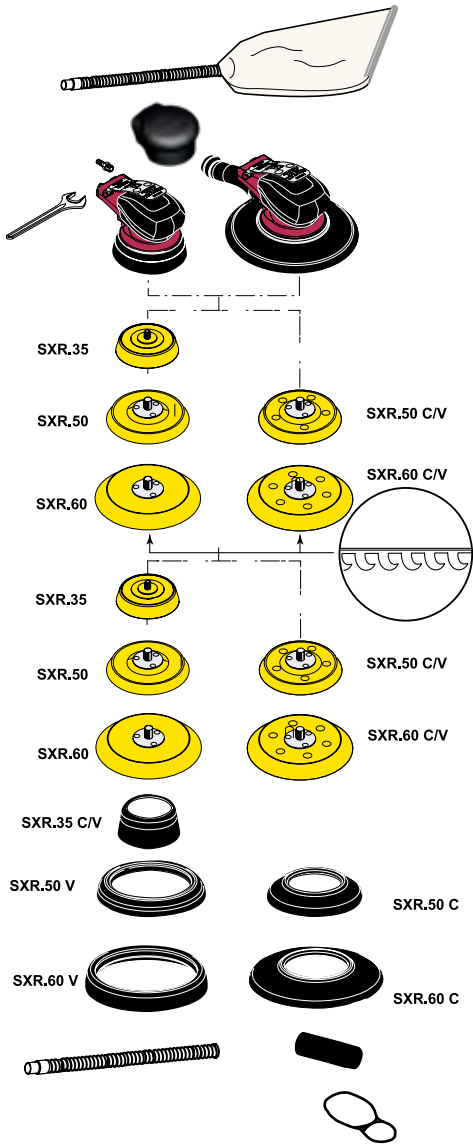

SXR. = 127 mm (5")

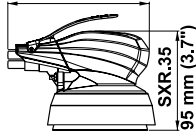

SXR.V/C = 186 mm (7.32")

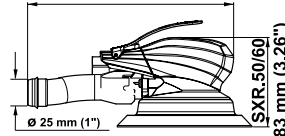

SXR.C = 133 mm (5.24")

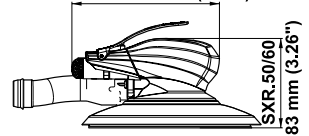

SXR.35. / SXR.50. / SXR.60.

ACCESSORIES INCLUDED

	PART NO.
• 1/4" air hose nipple for 6mm (1/4") ID hose	615 705 009 0
• Small grip (medium-size grip fitted on sander)	615 303 108 0
• Flat wrench 26mm across flats	615 801 078 0
• Complete dust extraction kit for SXRA..V and SXR.B..V version	615 396 264 0

PADS: Thread 5/16"-24	FOR HOOK & LOOP ABRASIVE	FOR HOOK & LOOP ABRASIVE (V) OR (C) WITH HOLES
• Pad ø 89mm (3.5") - 80gr - SXR(.)35(.)	615 990 158 0	-
• Pad ø 127mm (5") - 100gr - SXR(.)50	615 990 156 0	615 990 157 0
• Pad ø 150mm (6") - 130gr - SXR(.)60	615 990 154 0	615 990 155 0

OPTIONAL ACCESSORIES

PADS: Thread 5/16"-24	FOR SELF- ADHESIVE ABRASIVE	FOR SELF- ADHESIVE ABRASIVE (V) OR (C) WITH HOLES
• Pad ø 89mm (3.5") - 80gr - SXR(.)35(.)	615 990 163 0	-
• Pad ø 127mm (5") - 100gr - SXR(.)50	615 990 161 0	615 990 162 0
• Pad ø 150mm (6") - 130gr - SXR(.)60	615 990 159 0	615 990 160 0

VACUUM SKIRTS

• Vacuum skirt for SXR(.)35(.)	615 350 110 0
• Vacuum skirt for SXR(.)50C	615 350 107 0
• Vacuum skirt for SXR(.)60C	615 350 106 0
• Vacuum skirt for SXR(.)50V	615 350 103 0
• Vacuum skirt for SXR(.)60V	615 350 102 0

ADAPTOR

• Vacuum hose adaptor ø 25mm (1") / ø 32mm (1-1/4")	615 350 117 0
• Vacuum hose adaptor ø 25mm (1") / ø 28mm (1-1/8")	615 804 448 0

HOSE

• Dust extraction hose ø 25mm (1") L = 1.5m (60")	615 396 263 0
---	---------------

BAIL HOOK

• Bail hook	615 571 060 0
-------------	---------------

PADDIMENSIONS

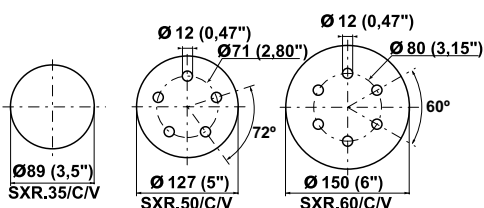

Random orbital sanders for abrasive discs Ø 89mm (3.5") - Ø 127mm (5") - Ø 150mm (6")

210 Watts (0.3 hp) - 12000 rpm

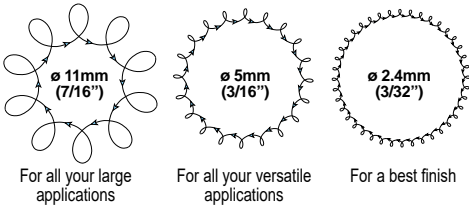

SXR(.)35



SXR(.)35C



SXR(.)35V



SXR(.)50



SXR(.)50C



SXR(.)50V



SXR(.)60



SXR(.)60C



SXR(.)60V

HOW TO SELECT YOUR SX SANDER — Eg: SXRA35C - SXR model / orbit Ø 2.4mm (3/32") / pad Ø 89mm (3.5") / with dust extraction

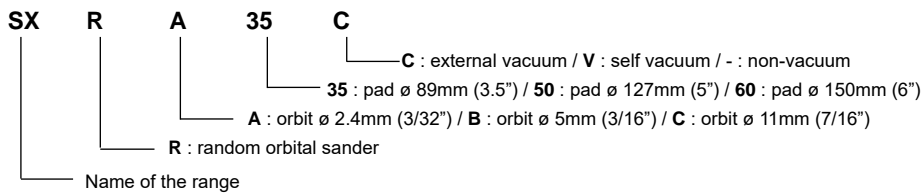

Supplied kit



*Sanders equipped with PSA pad

Caution: comply with the speeds recommended by component and abrasive manufacturers.

PAD SIZE		MODEL	PART NUMBER	MODEL	PART NUMBER	MODEL	PART NUMBER	WEIGHT		AIR CONSUMPTION AT MAX. OUTPUT		AIR INLET THREAD		HOSE INT Ø	
mm	in.							kg	lb	l/s	cfm	in.	mm	in.	
RANDOM ORBITAL SANDERS, ORBIT Ø 11mm (7/16")															
		NON-VACUUM		EXTERNAL VACUUM		SELF VACUUM									
Ø 150	6	SXRC60	615 170 462 0	SXRC60C	615 170 463 0	SXRC60V	615 170 464 0	0.88	1.94	8.0	16.6	1/4	6	1/4	
RANDOM ORBITAL SANDERS, ORBIT Ø 5mm (3/16")															
		NON-VACUUM		EXTERNAL VACUUM		SELF VACUUM									
Ø 89	3.5	SXRB35	615 170 209 0	SXRB35C	615 170 215 0	SXRB35V	615 170 212 0	0.8	1.7	8.0	16.6	1/4	6	1/4	
Ø 127	5	SXRB50	615 170 210 0	SXRB50C	615 170 216 0	SXRB50V	615 170 213 0	0.8	1.7	8.0	16.6	1/4	6	1/4	
Ø 127	5	SXRB50*	615 170 300 0					0.8	1.7	8.0	16.6	1/4	6	1/4	
Ø 150	6	SXRB60	615 170 211 0	SXRB60C	615 170 217 0	SXRB60V	615 170 214 0	0.8	1.7	8.0	16.6	1/4	6	1/4	
Ø 150	6	SXRB60*	615 170 317 0					0.8	1.7	8.0	16.6	1/4	6	1/4	
RANDOM ORBITAL SANDERS, ORBIT Ø 2.4mm (3/32")															
		NON-VACUUM		EXTERNAL VACUUM		SELF VACUUM									
Ø 89	3.5	SXRA35	615 170 218 0	SXRA35C	615 170 224 0	SXRA35V	615 170 221 0	0.8	1.7	8.0	16.6	1/4	6	1/4	
Ø 127	5	SXRA50	615 170 219 0	SXRA50C	615 170 225 0	SXRA50V	615 170 222 0	0.8	1.7	8.0	16.6	1/4	6	1/4	
Ø 150	6	SXRA60	615 170 220 0	SXRA60C	615 170 226 0	SXRA60V	615 170 223 0	0.8	1.7	8.0	16.6	1/4	6	1/4	

Accessories

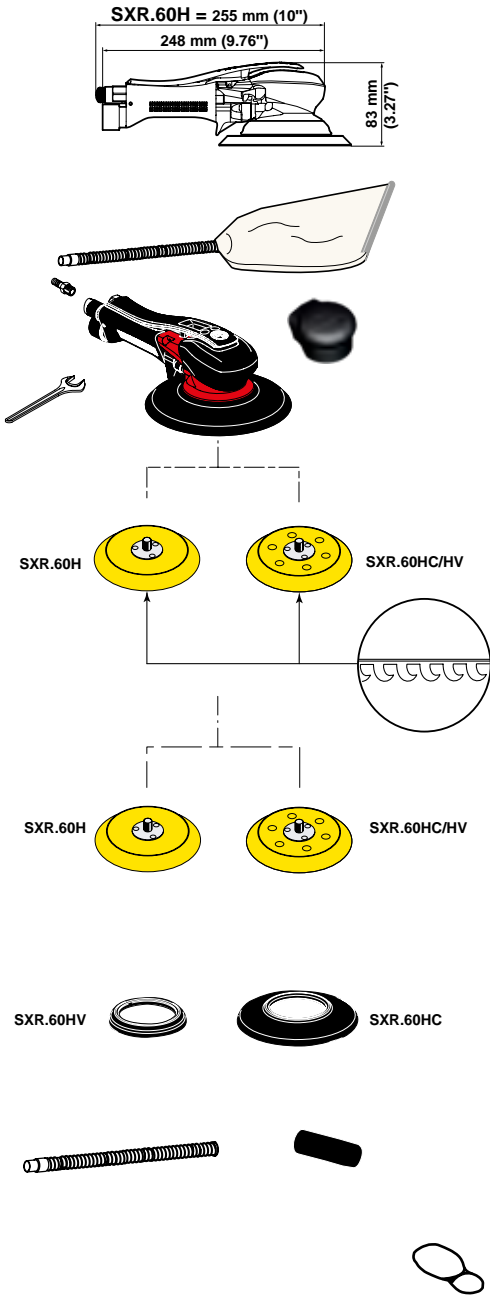

SXR.60H.

ACCESSORIES INCLUDED

	PART NO.
• 1/4" air hose nipple for 6mm (1/4") ID hose	615 705 009 0
• Small grip (medium-size grip fitted on sander)	615 303 108 0
• Flat wrench 26mm across flats	615 801 078 0
• Complete dust extraction kit for SXR.60HV version	615 396 264 0

PADS: Thread 5/16"-24	FOR HOOK & LOOP ABRASIVE	FOR HOOK & LOOP ABRASIVE (V) OR (C) WITH HOLES
• Pad ø 150mm (6") - 130gr - SXR(.)60	615 990 154 0	615 990 155 0

OPTIONAL ACCESSORIES

PADS: Thread 5/16"-24	FOR SELF-ADHESIVE ABRASIVE	FOR SELF-ADHESIVE ABRASIVE (V) OR (C) WITH HOLES
• Pad ø 150mm (6") - 130gr - SXR(.)60	615 990 159 0	615 990 160 0

VACUUM SKIRTS	
• Vacuum skirt for SXR(.)60HC	615 350 106 0
• Vacuum skirt for SXR(.)60HV	615 350 102 0

ADAPTOR	
• Vacuum hose adaptor ø 25mm (1") / ø 32mm (1-1/4")	615 350 117 0
• Vacuum hose adaptor ø 25mm (1") / ø 28mm (1-1/8")	615 804 448 0

HOSE	
• Dust extraction hose ø 25mm (1") L = 1.5m (60")	615 396 263 0

BAIL HOOK	
• Bail hook	615 571 060 0

PADDIMENSIONS

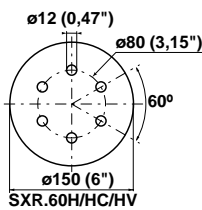

Random orbital sanders for abrasive discs Ø 150mm (6")

210 Watts (0.3 hp) - 12000 rpm

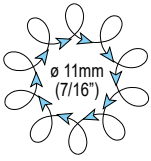

For all your large applications

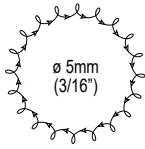

For all your versatile applications



SXR.60H



SXR.60HC



SXR.60HV

HOW TO SELECT YOUR SX SANDER — SXR60H - SXR model / orbit 5mm (3/16") / pad Ø 150mm (6") / Two handed / non vacuum

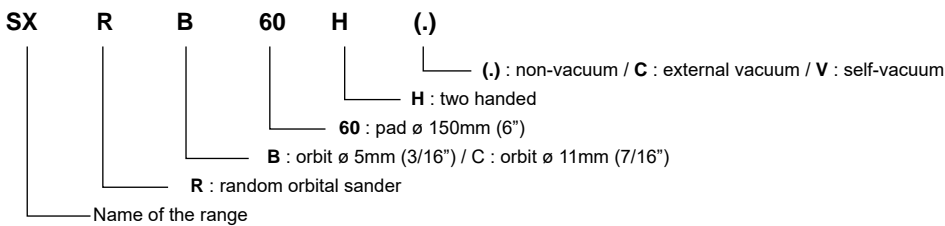

*Sanders equipped with PSA pad

Caution: comply with the speeds recommended by component and abrasive manufacturers.

PAD SIZE		MODEL	PART NUMBER	MODEL	PART NUMBER	MODEL	PART NUMBER	WEIGHT		AIR CONSUMPTION AT MAX. OUTPUT		AIR INLET THREAD	HOSE INT Ø		
mm	in.							kg	lb	l/s	cfm	in.	mm	in.	
RANDOM ORBITAL SANDERS, ORBIT Ø 11mm (7/16")															
		NON-VACUUM			EXTERNAL VACUUM			SELF VACUUM							
Ø 150	6	SXRC60H	615 170 465 0	SXRC60HC	615 170 466 0	SXRC60HV	615 170 467 0	0.88	1.94	8.0	16.6	1/4	6	1/4	
RANDOM ORBITAL SANDERS, ORBIT Ø 5mm (3/16")															
		NON-VACUUM			EXTERNAL VACUUM			SELF VACUUM							
Ø 150	6	SXRB60H	615 170 355 0	SXRB60HC	615 170 362 0	SXRB60HV	615 170 359 0	0.9	2.0	8.0	16.6	1/4	6	1/4	
Ø 150	6	SXRB60H*	615 170 356 0												

Accessories

SXO.. = 127 mm (5")

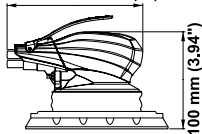

SXO..V = 186 mm (7.32")

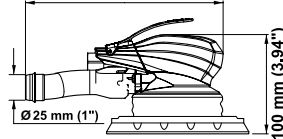

SXO..C = 133 mm (5.24")

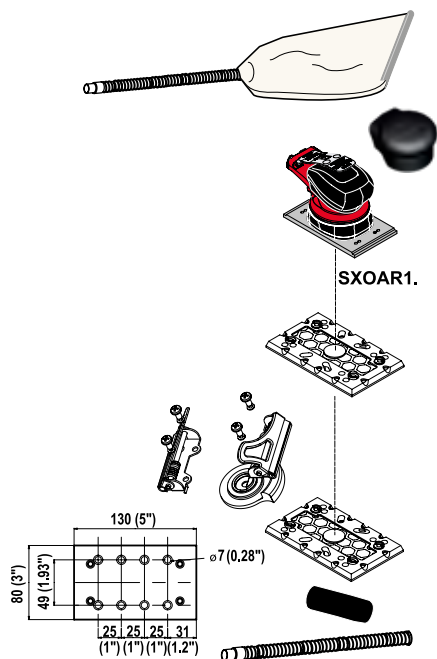
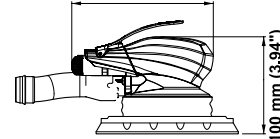

SXOAR1.

ACCESSORIES INCLUDED

	PART NO.
• 1/4" air hose nipple for 6mm (1/4") ID hose	615 705 009 0
• Small grip (medium-size grip fitted on sander)	615 303 108 0
• Flat wrench 26mm across flats	615 801 078 0
• Complete dust extraction kit for SXOA..V version	615 396 264 0

PAD FOR HOOK & LOOP ABRASIVE

	PART NO.
• Pad 80x130mm (3x5") for SXOAR..	615 350 121 0

OPTIONAL ACCESSORIES

	PART NO.
• Paper holder kit	615 396 413 0
• Pad 80x130mm (3x5") for SXOAR..	615 350 123 0

ADAPTOR

• Vacuum hose adaptor \varnothing 25mm (1") / \varnothing 32mm (1-1/4")	615 350 117 0
• Vacuum hose adaptor \varnothing 25mm (1") / \varnothing 28mm (1-1/8")	615 804 448 0

HOSE

• Dust extraction hose \varnothing 25mm (1") L = 1.5m (60")	615 396 263 0
---	---------------

PADDIMENSIONS

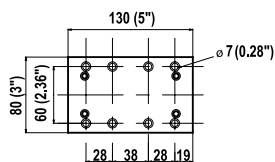

Orbital sanders for abrasive sheets 80 x 130mm (3" x 5") - 147 x 100mm (6" x 4")

210 Watts (0.3 hp) - 10000 rpm



SXOAR1



SXOAR1C



SXOAR1V



SXOAT1



SXOAR1 equipped with paper holder kit P.N 615 396 413 0

HOW TO SELECT YOUR SXO SANDER — Eg: SXOAT1C - SXO model / orbit ø 2.4mm (3/32") iron pad / with dust suction

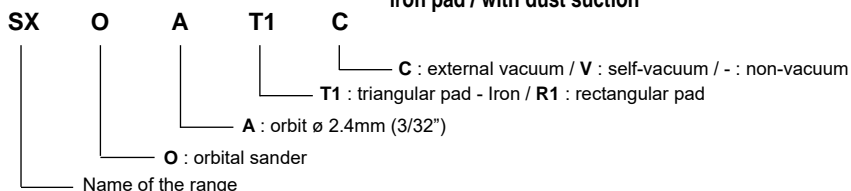

Supplied kit



Caution: comply with the speeds recommended by component and abrasive manufacturers.

PAD SIZE		MODEL	PART NUMBER	MODEL	PART NUMBER	MODEL	PART NUMBER	WEIGHT		AIR CONSUMPTION AT MAX. OUTPUT		AIR INLET THREAD	HOSE INT Ø	
mm	in.							kg	lb	l/s	cfm	in.	mm	in.
ORBITAL SANDERS, ORBIT ø 2.4mm (3/32")														
		NON-VACUUM		EXTERNAL VACUUM		SELF VACUUM								
80x130	3x5	SXOAR1	615 170 233 0	SXOAR1C	615 170 237 0	SXOAR1V	615 170 235 0	1.0	2.2	8.0	16.6	1/4	6	1/4
147x100	6x4	SXOAT1	615 170 234 0					1.0	2.2	8.0	16.6	1/4	6	1/4

Accessories

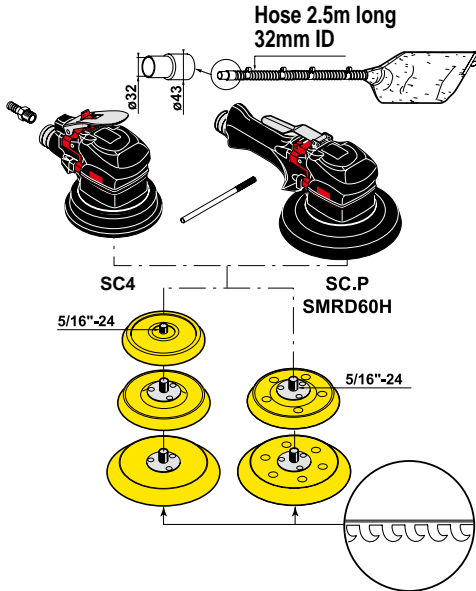
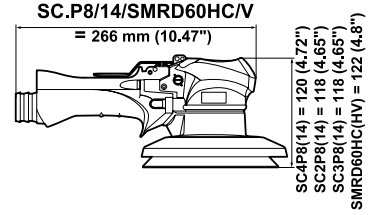
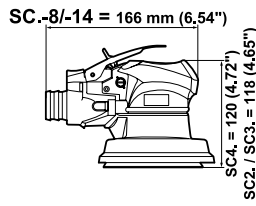
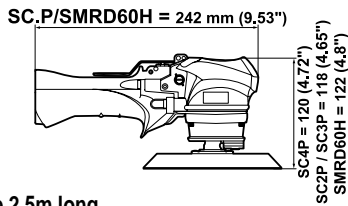
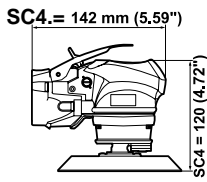

SC4.. / SC..P / SMRD60..

ACCESSORIES INCLUDED

	PART NO.
• 1/4" air hose nipple for 8mm (5/32") ID hose	615 704 019 0
• Clamping lever	615 595 202 0
• Complete dust extraction kit for version (SC.-14/SMRD60HV)	615 399 471 0

PADS: Thread 5/16" - 24	FOR HOOK & LOOP ABRASIVE	FOR HOOK & LOOP ABRASIVE (-8) OR (-14) (C) OR (V) WITH HOLES
• Pad ø 110mm (4-3/8") - SC2P/8/14	615 990 102 0	-
• Pad ø 127mm (5") - SC3P	615 990 156 0	615 990 157 0
• Pad ø 150mm (6") - SC4(P) - SRMD60H.	615 990 154 0	615 990 155 0

OPTIONAL ACCESSORIES

PADS: Thread 5/16" - 24	FOR SELF-ADHESIVE ABRASIVE	FOR SELF-ADHESIVE WITH HOLES (-8) OR (-14) (C) OR (V)
• Pad ø 110mm (4-3/8") - SC2P/8/14	615 990 101 0	-
• Pad ø 127mm (5") - SC3P	615 990 111 0	615 990 110 0
• Pad ø 150mm (6") - SC4(P) - SRMD60H.	615 990 119 0	615 990 118 0

PAD DIMENSIONS

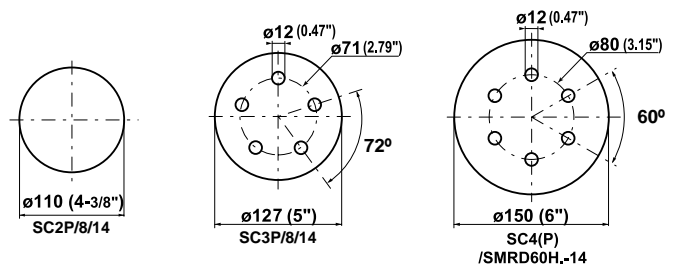

Random orbital sanders for abrasive discs Ø 110mm (4-3/8") - Ø 127mm (5") Ø 150mm (6")

375 Watts (0.5 hp) - 10000 rpm

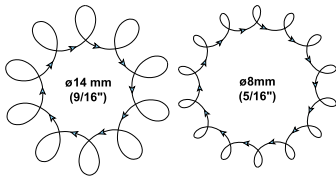

SC4



SC4P



SC4-8



SC4P8 - SMRD60HC



SMRD60H



SC4P14 - SMRD60HV

Caution: comply with the speeds recommended by component and abrasive manufacturers.

PAD SIZE		MODEL	PART NUMBER	MODEL	PART NUMBER	MODEL	PART NUMBER	WEIGHT		AIR CONSUMPTION AT MAX. OUTPUT		AIR INLET THREAD		HOSE INT. Ø	
mm	in.							kg	lb	l/s	cfm	in.	mm	in.	
SANDERS WITH PALM GRIP, ORBIT Ø 8mm (5/16")															
		NON-VACUUM		EXTERNAL VACUUM		SELF VACUUM									
ø 150	6	SC4	615 170 081 0	SC4-8	615 170 093 0	SC4-14	615 170 087 0	1.3	2.86	11	23	1/4	8	5/16	
SANDERS WITH HANDLE GRIP, ORBIT Ø 8mm (5/16")															
		NON-VACUUM		EXTERNAL VACUUM		SELF VACUUM									
ø 110	4-3/8	SC2P	615 170 077 0	SC2P8	615 170 089 0	SC2P14	615 170 083 0	1.2	2.64	11	23	1/4	8	5/16	
ø 127	5	SC3P	615 170 079 0	SC3P8	615 170 091 0	SC3P14	615 170 085 0	1.3	2.86	11	23	1/4	8	5/16	
ø 150	6	SC4P	615 170 078 0	SC4P8	615 170 090 0	SC4P14	615 170 084 0	1.4	3.08	11	23	1/4	8	5/16	
LARGE ORBIT SANDERS WITH HANDLE GRIP, ORBIT Ø 14mm (9/16")															
		NON-VACUUM		EXTERNAL VACUUM		SELF VACUUM									
ø 150	6	SMRD60H	615 170 280 0	SMRD60HC	615 170 281 0	SMRD60HV	615 170 282 0	1.3	2.86	11	23	1/4	8	5/16	

Accessories

SV3 = 142mm (5.59")

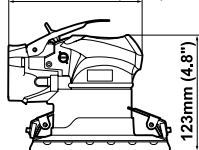

SV.P = 242 mm (9.53")

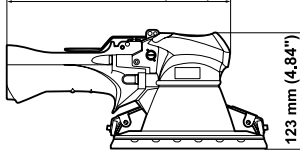

SV.-8/-14 = 166 mm (6.54")

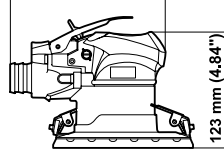

SV.P8/14 = 266 mm (10.47")

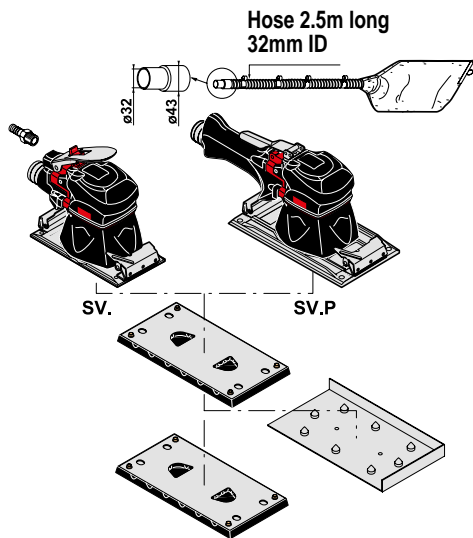
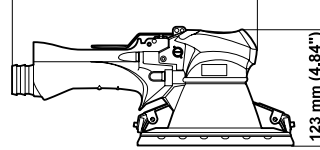

Hose 2.5m long
32mm ID

SV.

SV.P

8 side holes

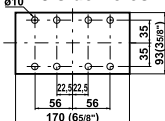

SV.. / SV..P

ACCESSORIES INCLUDED

	PART NO.
• 1/4" air hose nipple for 8mm (5/16") ID hose	615 704 019 0
• Complete dust extraction kit for version (-14)	615 399 471 0

PADS AND DRILLING PLATE	PAD	DRILLING PLATE FOR RELEASE (-8) OR (-14)
• Pad 170x93mm (6-5/8" x 3-5/8") - SV3(P)	615 350 018 0	615 990 094 0
• Pad 215x113mm (8-1/2" x 4-1/2") - SV4P	615 350 019 0	615 990 095 0

OPTIONAL ACCESSORIES

	PART NO.
• Pad 170x93mm (6-5/8" x 3-5/8") - 8 side holes SV3(P)	615 350 057 0

PADDIMENSIONS

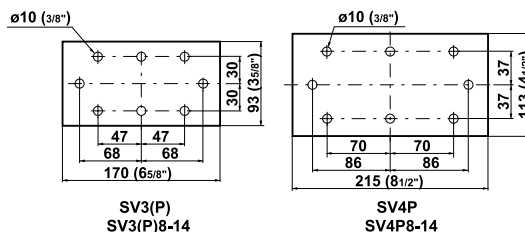

Orbital sanders for abrasive sheets 170 x 93mm (6-5/8" x 3-5/8") - 215 x 113mm (8-1/2" x 4-1/2")

375 Watts (0.5 hp) - 8000 rpm



SV3



SV3P



SV3-8



SV3P8



SV3P14

Caution: comply with the speeds recommended by component and abrasive manufacturers.

PAD SIZE		MODEL	PART NUMBER	MODEL	PAR NUMBER	MODEL	PART NUMBER	WEIGHT		AIR CONSUMPTION AT MAX. OUTPUT		AIR INLET THREAD	HOSE INT Ø		
mm	in.							kg	lb	l/s	cfm	in.	mm	in.	
SANDERS WITH PALM GRIP, ORBIT Ø 5mm (3/16")															
		NON-VACUUM		EXTERNAL VACUUM		SELF VACUUM									
170x93	65/8 x 35/8	SV3	615 170 066 0	SV3-8	615 170 074 0	SV3-14	615 170 070 0	1.7	3.74	11	23	1/4	8	5/16	
SANDERS WITH HANDLE GRIP, ORBIT Ø 5mm (3/16")															
		NON-VACUUM		EXTERNAL VACUUM		SELF VACUUM									
170x93	65/8 x 35/8	SV3P	615 170 067 0	SV3P8	615 170 075 0	SV3P14	615 170 071 0	1.8	3.96	11	23	1/4	8	5/16	
215x113	8 1/2 x 4 1/2	SV4P	615 170 068 0	SV4P8	615 170 076 0	SV4P14	615 170 072 0	1.9	4.19	11	23	1/4	8	5/16	

Accessories

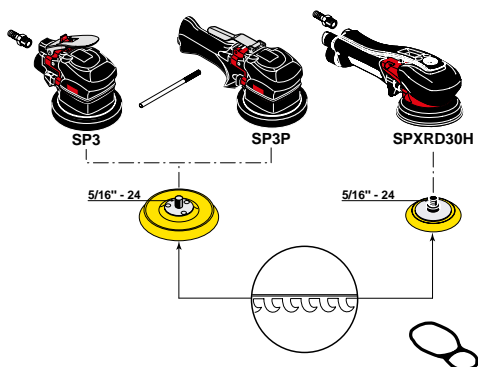
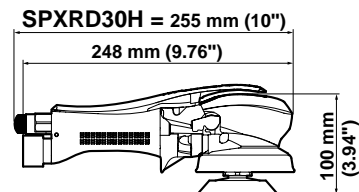
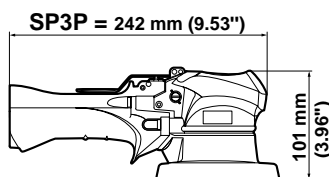
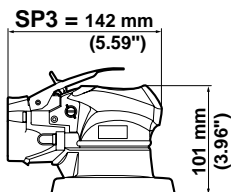

SP3 / SP3P / SPXRD30H

ACCESSORIES INCLUDED

	SP3/SP3P	SPXRD30H
• 1/4" air hose nipple for 8mm (5/16") ID hose	615 704 019 0	
• 1/4" air hose nipple for 6mm (1/4") ID hose		615 705 009 0
• Clamping lever	615 595 202 0	
• Small grip (medium-size grip fitted on sander)		615 303 109 0
• Bail hook		615 571 060 0

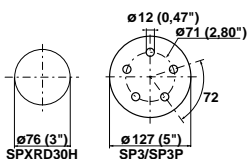

PADS: Thread 5/16"-24	FOR HOOK & LOOP ABRASIVE
• Pad $\varnothing 127$ mm (5") for SP3 / SP3P	615 990 123 0
• Pad $\varnothing 76$ mm (3") for SPXRD30H	615 990 178 0



Random orbital polishers Ø 76mm (3") - Ø 127mm (5")

210 and 375 Watts (0.3 and 0.5 hp) - 10000 and 12000 rpm

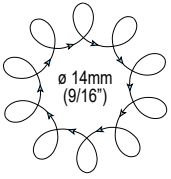

SP3



SP3P



SPXRD30H

Caution: comply with the speeds recommended by component and abrasive manufacturers.

PAD SIZE		MODEL	PART NUMBER	WEIGHT		AIR CONSUMPTION AT MAX. OUTPUT		AIR INLET THREAD	HOSE INT Ø		
mm	in.			kg	lb	l/s	cfm	in.	mm	in.	
POLISHER WITH PALM GRIP, ORBIT Ø 14mm (9/16")											
NON-VACUUM											
Ø 127	5	SP3	615 170 198 0	1.2	2.64	11	23	1/4	8	5/16	
POLISHER WITH HANDLE GRIP, ORBIT Ø 14mm (9/16")											
NON-VACUUM											
Ø 76	3	SPXRD30H	615 170 332 0	0.9	1.98	11	23	1/4	8	5/16	
Ø 127	5	SP3P	615 170 197 0	1.3	2.86	11	23	1/4	8	5/16	

Belt sanders

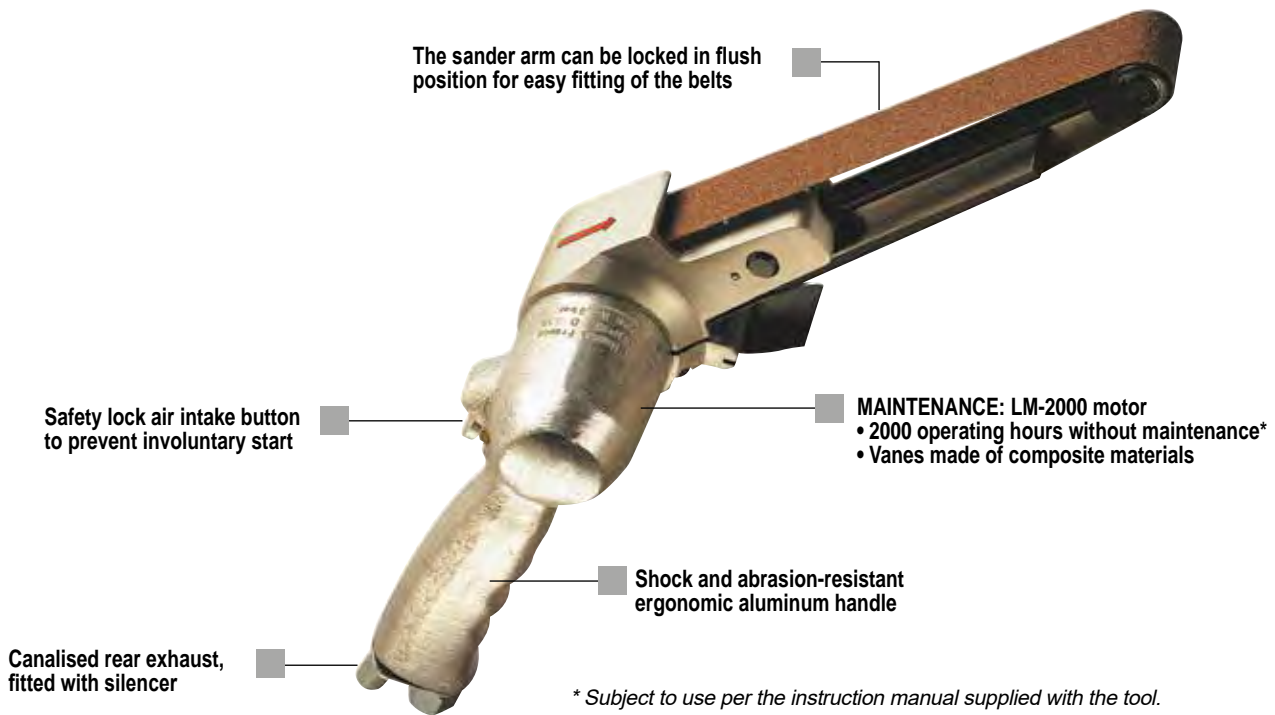

* Subject to use per the instruction manual supplied with the tool.

Accessories

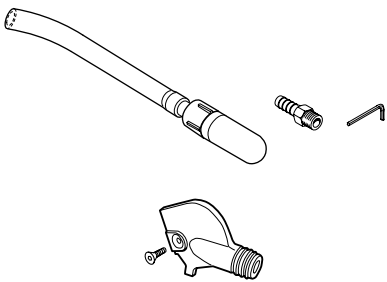
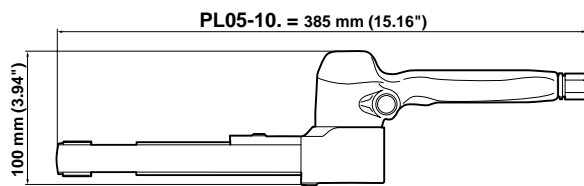

PL05-10D / PL05-10E / PL05-10F

ACCESSORIES INCLUDED

	PART NO.
• Exhaust hose	615 396 022 0
• 1/4" air hose nipple for 6mm (1/4") ID hose	615 705 009 0
• Hex. key 4 mm	615 802 054 0

OPTIONAL ACCESSORIES

	PART NO.
• Suction cap for 32mm (1-1/4") ID vacuum hose	321003
• Screw FHc M4x10	615 616 118 0

OPTIONAL ACCESSORIES

COATED ABRASIVE BELTS

L x l		GRIT NUMBER			
mm	in.	P40	P60	P80	P100
480 x 16	18-7/8" x 5/8		615 811 218 0	615 811 219 0	615 811 220 0
480 x 20	18-7/8" x 25/32	615 811 223 0	615 811 224 0	615 811 225 0	615 811 226 0
480 x 25	18-7/8" x 63/64	615 811 230 0			

L x l		GRIT NUMBER			
mm	in.	P120	P150	P180	P240
480 x 16	18-7/8" x 5/8	615 811 221 0	615 811 222 0		
480 x 20	18-7/8" x 25/32	615 811 227 0	615 811 228 0	615 811 229 0	
480 x 25	18-7/8" x 63/64		615 811 235 0	615 811 236 0	

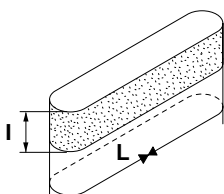

Belt sanders

300 Watts (0.4 hp) - 16000 rpm



A



B



C



Caution: comply with the speeds recommended by component and abrasive manufacturers.

PIC REF	MODEL	PART NUMBER	FREE SPEED	BELT SIZE		POWER		WEIGHT		AIR CONSUMPTION AT FREE SPEED		AIR INLET THREAD		HOSE INT. Ø	
				rpm	mm	in.	W	hp	kg	lb.	l/s	cfm	in.	mm	in.
A	PL05-10D	615 170 131 0	16000	480 x 16	18-7/8 x 5/8	300	0.4	1.2	2.6	12	25.4	1/4	6	1/4	
B	PL05-10E	615 170 132 0	16000	480 x 20	18-7/8 x 25/32	300	0.4	1.2	2.6	12	25.4	1/4	6	1/4	
C	PL05-10F	615 170 133 0	16000	480 x 25	18-7/8 x 63/64	300	0.4	1.2	2.6	12	25.4	1/4	6	1/4	

Accessories

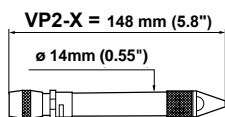

VP2-X

ACCESSORIES INCLUDED

	PART NO.
• Air Hose - 3.2mm bore - Length 2m (78.7") - 1/8" - 1/4" BSP	75902
• Tungsten carbide tipped needle	63213
• Key	63533

D144-T-.. / D172-L / AV101

ACCESSORIES INCLUDED

ITEM	APPLICATION	PART NO.		
		D144-T	D172-L	AV101
• Spindle Wrench		164433	15533	
• Clamp Nut Wrench		29443		
• Hex. Key - 4mm (5/32") A/F		204903	204903	
1 Saw Blade - diamond coated 64mm (2.5") dia.	Fibreglass	32732		
1 Saw Blade - 80 teeth 45mm (1.77") dia.	Soft Steel <1.2mm (3/64")			
1 Saw Blade 64mm (2.5") dia.	Plastics		90762	
1 Saw Blade - teflon coated 80mm (3.15") dia.	Plastics		90772	
2 Saw Blade 50.8mm (2") radius x 50mm (1.97") wide	Soft Wood		90832	
3 Depth Gauge			27262	
4 Upholstery Nozzle				106443
5 Crevice Nozzle				106533

OPTIONAL ACCESSORIES

ITEM	APPLICATION	PART NO.	
		D144-T	D172-L
1 Saw Blade - 80 teeth 45mm (1.77") dia	Soft Steel <1.2mm (3/64")		76362
6 Saw Blade 64mm (2.5") dia.	Wood	34252	
6 Saw Blade 50mm (1.97") dia.	Soft Steel >1.2mm (3/64") max depth 7mm		
6 Saw Blade 50mm (1.97") dia.	Hard Steel <1.2mm (3/64") max depth 10mm (3/8")		
6 Saw Blade 50mm (1.97") dia.	Aluminium max depth 10mm (3/8")		
7 Dust Extraction Hood includes 2m hose - 32mm (1.26") ID			78472
6 Saw Blade - diamond tipped 64mm (2.5") dia.	Fibreglass		16962
6 Saw Blade - diamond tipped 1.2mm (3/64") tooth pitch - 64mm (2.5") dia.	Fibreglass		90722
6 Saw Blade - diamond tipped 1.2mm (3/64") tooth pitch - 80mm (3.15") dia.	Fibreglass		90732
6 Saw Blade - 1.5mm (0.06") tooth pitch 51mm (2") dia.	Soft Wood		90782
6 Saw Blade - 1.8mm (0.07") tooth pitch 64mm (2.5") dia.	Soft Wood		90792
6 Saw Blade - 1.5mm (0.06") tooth pitch 76mm (3") dia.	Soft Wood		90802
8 Saw Blade 22mm (0.87") radius x 15mm (19/32") wide	Soft Wood		90822
9 Saw Blade 63.5mm (2.5") dia. 60mm (2.36") + 16mm (5/8") segments	Soft Wood		90842

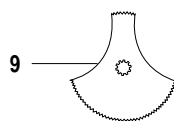
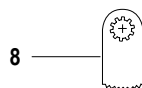
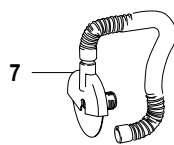
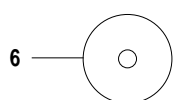
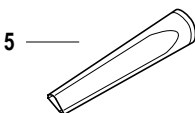
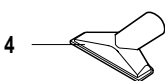
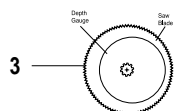
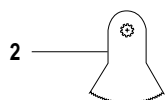
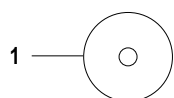

Miscellaneous



A



B



C



D

PIC REF	MODEL	PART NUMBER	BLOWS PER MINUTE	WEIGHT		AIR CONSUMPTION AT FREE SPEED		AIR INLET THREAD	HOSE INT. Ø	
			Blows/min	kg	lb.	l/s	cfm	in.	mm	in.
A	VP2-X	671094	11400	0.1	0.2	0.9	1.9	1/8	3.2	1/8

AIR SCRIBE

PIC REF	MODEL	PART NUMBER	FREE SPEED	OSCILLATING FREQUENCY	BLADE Ø		WEIGHT		LENGTH		AIR CONSUMPTION		AIR INLET THREAD	HOSE INT. Ø	
			rpm	c/min	mm	in.	kg	lb.	mm	in.	l/s	cfm	in.	mm	in.
B	D144	615 170 526 0	3100	-	64	2.5	0.83	1.83	214	8.43	9.4	19.9	1/4 BSP	10	3/8

FIBREGLASS SAW - capacity 13mm (1/2") depth

OSCILLATING SAW															
D	D172	615 170 527 0	-	20000	80	3.2	0.76	1.67	265.2	10.44	9.5	20	1/4 BSP	10	3/8

VACUUM CLEANER

C	AV101	128534	-	-	-	-	0.7	1.54	202	7.95	5.9	12.5	1/4 BSP	6	1/4
----------	--------------	---------------	---	---	---	---	-----	------	-----	------	-----	------	---------	---	-----



Air Line Accessories

Desoutter Air Line Accessories are specially developed to be used with Desoutter Tools & Equipments.

Desoutter Air Line Accessories can also be used with other pneumatic products.

All accessories can be used for other applications with any pneumatic equipments.

Desoutter Air Preparation Units are designed to help you get maximum performance from your tools.

They ensure minimal pressure drop and thus minimum energy losses in the air distribution system, benefiting the environment and cutting your operating costs.

The lifetimes of your tools will be extended by using air preparation units and with that comes lower repair costs and less downtime. A correct air installation guarantees productivity and good total economy.

Air dryers and filters can cause a 0.2 - 0.3 bar (3-4 psi) pressure drop. However, for many applications these may be essential.

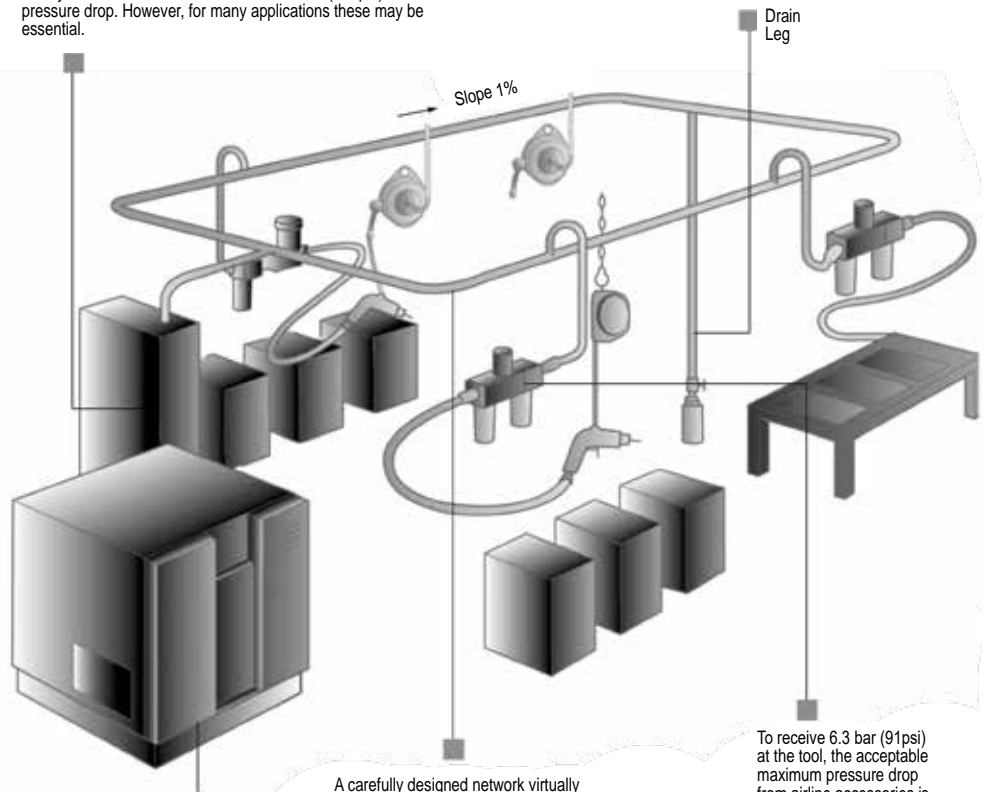

A normal compressor can deliver up to 7.5 bar (109 psi) air line pressure, depending on start and stop settings.

A carefully designed network virtually eliminates pressure drop. We recommend a Ring Main layout which has a slope away from the input of 1%.

To receive 6.3 bar (91psi) at the tool, the acceptable maximum pressure drop from airline accessories is 0.6 bar (9 psi). A combination of high performance components and careful engineering will achieve this.

When developing the Desoutter Air Line Accessories range, we have focused on Performance, Quality, Ergonomics and Safety. Based on this, we now offer a wide range of accessories for optimal air line installation.

Our accessories enable to reach higher productivity with lower energy consumption, a sustainable reduction of energy costs and an extended lifetime of your tools.

Performance

In order to get the best performance out of your air line installation it is key to supply air at a constant pressure (6.3 bar) This, together with minimizing the pressure drop, is the primary focus when designing the Desoutter couplings, hoses and FRLs.

The result is not only a better performance in terms of a reduction of energy costs but also in a better lifetime of the tools.

Ergonomics and Safety

To further improve the comfort of use for our customers we now offer hoses in our EFFI line with lower weight and more flexible. In combination with Easy Flow, Safety couplings, Airflex and high quality balancers you can build up a workplace where the operators' safety and ergonomics are in focus.

Quality

All our products are developed to perform in industrial applications. Desoutter Accessories are made with the highest quality materials to ensure the best possible performance and lifetime of the tools.

Hoses

Desoutter offers the highest quality of PVC, Rubber and Polyurethane hoses in the Industrial Line to cover the different needs of applications with Power Tools.

In addition to this, the EFFI series is designed with special features such as low weight and flexibility, to meet the highest ergonomic demands, as well as antistatic for applications with ESD demands.

HOSES

HOSERECOMMENDATIONS

DESCRIPTION	EFFI MAX	POLYURETHAN	RUBBER
Flexibility	++	++	+
Lightweigh	++	++	+
Outdoor	+++	+	+++
Spark resistant	+++	-	+++
Rough environment	+++	++	+++
Antistatic	+++	-	+++
Temperature range	-40 to +194F° -40 to +90°C	-22 to +176F° -30 to +80°C	-40 to +194F° -40 to +90°C



At recommended air flow the pressure drop is 0.2 bar (2.9 PSI) with a hose length of 5m (16ft). Recommendation is to upgrade one size in diameter for every 10m (32.8ft) of hose length

EFFI Series

EFFI is a unique premium line of hoses designed with special features such as antistatic, extreme low weight, resistance and durability that will help the operator to maximize the tool productivity.

EFFIMAXHOSES

Aimed to generic grinding applications

- Exeme low weight
- Antistatic
- Rubber hose
- Soft and flexible
- Welding spatter resistant



DIMENSIONS (IDxOD)		LENGTH		MAX WORKING PRESSURE*	AIR FLOW		WEIGHT PER 20M / 65.6FT		PART NUMBER
in. ID	mm	ft	m	PSI (bar)	cfm	l/s	lb	kg	
3/8	9.5x12.5	65.6	20		27.6	13	6.4	2.9	894 016 992 1
1/2	13x18.6	65.6	20	232 (16)	44.5	21	8.6	3.9	615 810 900 0
5/8	16x22.5	65.6	20	232 (16)	91.1	43	10.6	4.8	615 810 901 0
3/4	20x26.1	65.6	20	232 (16)	159	75	11.9	5.4	615 810 902 0

RUBBERHOSES

Aimed to the most demanding tasks in construction, mining, shipyards, foundries etc.

- Durable
- Antistatic
- Grinding and welding spatter resistant



DIMENSIONS (IDxOD)		LENGTH		MAX WORKING PRESSURE*	AIR FLOW		WEIGHT PER 20M / 65.6FT		PART NUMBER
in. ID	mm	ft	m	PSI (bar)	cfm	l/s	lb	kg	
3/8	10x16	65.6	20	232 (16)	27.5	13	7.9	3.6	615 810 864 0
1/2	12.5x19.1	65.6	20	232 (16)	44.5	21	10.4	4.7	615 810 865 0
5/8	16x23	65.6	20	232 (16)	91.1	43	13.4	6.1	615 810 866 0
3/4	20x26.6	65.6	20	232 (16)	159	75	17.2	7.8	615 810 868 0
1	25x34	65.6	20	232 (16)	265	125	26.0	11.8	615 810 870 0

POLYURETHANEHOSES

Aimed to heavy duty applications for indoor and use

- Oil resistant
- Flexible
- Long service life
- PVC free: Environment friendly



DIMENSIONS (IDxOD)		LENGTH		MAX WORKING PRESSURE*	AIR FLOW		WEIGHT PER 25M / 82FT		PART NUMBER
in. ID	mm	ft	m	PSI (bar)	cfm	l/s	lb	kg	
1/4	6.5x10	82	25	290 (20)	8.5	4.0	2.9	1.3	615 804 623 0
5/16	8x12	82	25	290 (20)	15.9	7.5	4.8	2.2	615 804 624 0
3/8	9.5x13	82	25	232 (16)	27.5	13.0	5.5	2.5	615 804 625 0
1/2	13x18	82	25	188 (13)	44.5	21.0	8.8	4.0	615 804 626 0

* With a safety factor of 37.4 psi at 68F° (3 bar at 20°C)
(at the max temp of +140F° (+60°C) the working pressure should be reduced by 50%)

Hoses

HOSE KITS

Hose kits are equipped with end thread fittings and available in short length, ready to connect and ready to use.



DIMENSIONS (IDxOD)		MALE		LENGHT		PART NUMBER		HOSE MATERIAL
in. ID	mm	in.	ft	m	NPT	BSP		
1/4	6.5x10	1/4	26.2	8	615 811 213 0	615 804 627 0	PU	
5/16	8x12	1/4	26.2	8	615 811 214 0	615 804 628 0	PU	
3/8	10x13	1/4	26.2	8		615 804 629 0	PU	
3/8	10x13	3/8	26.2	8	615 811 240 0	615 811 238 0	PU	
1/2	13x18	1/2	26.2	8	615 811 216 0	615 804 630 0	PU	
1/2	13x18	3/8	26.2	8	615 811 241 0	615 811 239 0	PU	
5/8	16x23	1/2	26.2	8	615 811 268 0	615 811 267 0	Rubber	

EFFI MAX WHIPS

Always use a hose whip between the tool and the air supply hose. It provides safety and longer tool air inlet life.



HOSE DIAM.		THREAD SIZE		HOSE LENGHT		PART NUMBER	
in.	mm	in.	ft	m	NPT	BSP	
1/4	6.5	1/4	2.0	0.6			
3/8	10	1/4	2.0	0.6	CA047270	615 811 192 0	
1/2	13	3/8	2.0	0.6	CA049271	615 811 264 0	
1/2	13	1/2	2.0	0.6	CA049270	615 811 193 0	
5/8	16	1/2	2.0	0.6	615 811 266 0	615 811 265 0	

POLYURETHANE SPIRAL HOSE

Spiral hose are especially adapted for tools used at varying distances. Vertically or horizontally, together with a balancer spiral hose, it is a step forward in ergonomics. Equipped with ball bearing at one end (except the 11x16), they can be directly connected at the tool outlet, avoiding the hose to twist

- Self retractable
- Light and flexible
- Strong and durable

DIMENSIONS (IDxOD)		MALE THREADS		WORKING LENGTH		LENGHT			PARTNUMBER	
in. ID	mm	in.	ft	m	A in. (mm)	B in. (mm)	C in. (mm)	NPT	BSP	
1/4	6.5x10	1/4	6.6	2	19.7 (500)	5.5 (140)	5.9 (150)	615 810 967 0	615 804 635 0	
1/4	6.5x10	1/4	13.1	4	19.7 (500)	13 (330)	5.9 (150)	615 810 968 0	615 804 636 0	
1/4	6.5x10	1/4	19.7	6	19.7 (500)	20.1 (510)	5.9 (150)	615 810 969 0	615 804 637 0	
1/4	6.5x10	1/4	26.2	8	19.7 (500)	27.6 (700)	5.9 (150)	615 810 970 0	615 804 638 0	
5/16	8x12	3/8	6.6	2	19.7 (500)	5.1 (130)	5.9 (150)	615 810 971 0	615 804 639 0	
5/16	8x12	3/8	13.1	4	19.7 (500)	11.8 (300)	5.9 (150)	615 810 972 0	615 804 640 0	
5/16	8x12	3/8	19.7	6	19.7 (500)	18.1 (460)	5.9 (150)	615 810 973 0	615 804 641 0	
5/16	8x12	3/8	26.2	8	19.7 (500)	24.8 (630)	5.9 (150)	615 810 974 0	615 804 642 0	
7/16	11x16	3/8	6.6	2	19.7 (500)	4.7 (120)	5.9 (150)	615 810 975 0	615 804 643 0	
7/16	11x16	3/8	13.1	4	19.7 (500)	10.6 (270)	5.9 (150)	615 810 976 0	615 804 644 0	
7/16	11x16	3/8	19.7	6	19.7 (500)	16.5 (420)	5.9 (150)	615 810 977 0	615 804 645 0	
7/16	11x16	3/8	26.2	8	19.7 (500)	22.4 (570)	5.9 (150)	615 810 978 0	615 804 646 0	

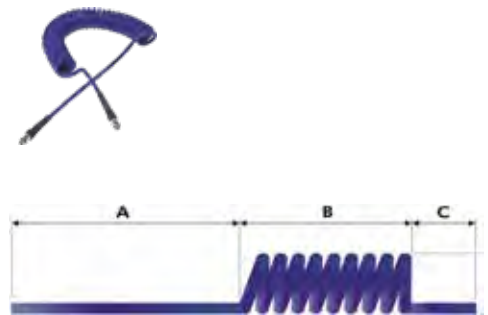

AIR FLEX RANGE



THE NEW AIR FLEX MAKES ALL RIGID HOSES FLEXIBLE AND MULTI-DIRECTIONAL.

Easy: less effort due to hose rigidity, makes work easier in hard to reach areas. Less wear: no more premature hose wear. Comfort and safety: no twisting, the hose remains in the ideal working position and lower the risk of tendinitis.

AIR FLEX

Aimed to improve the working ergonomy, Air flex connectors can rotate 360° eliminating efforts when working in cramped spaces

MULTI DIRECTION SWIVEL CONNECTOR	MAX RECOMMENDED FLOW		LENGTH		PART NUMBER		
	cfm	l/s	mm	in.	BSP	NPT	R
Air Flex 1/4"	25	12	67	2.63	615 804 746 0	615 804 747 0	615 995 559 0
Air Flex 3/8"	74	35	82	3.23	615 804 748 0	615 804 749 0	615 995 557 0
Air Flex 1/2"	74	35	82	3.23	615 804 750 0	615 804 751 0	615 995 558 0

AIR FLEX



Fastening accessories

Fastener Head Type	Drivers	Output
POZIDRIV/SUPADRIV	4mm Wing Shank	Exx TORX SOCKET SIZE XX
PHILLIPS	5mm Wing Shank	SWxx SOCKET SIZE XX
TORX	4mm Halfmoon	T TORX SIZE XX
TORXTAMPERPROOF	1/4" Hex** Insert (C6.3) (ISO1173/ DIN3126)	INxx HEX BIT SIZE XX
TORXPLUS	1/4" Hex Power Drive (E6.3) (ISO1173/ DIN3126)	XZNxx TORX 12 BIT SIZE XX
INTERNALHEX	5/16" Hex Power Drive	
EXTERNALHEX	3mm Hex Power Drive (A3) (ISO1173)	
SLOT	Thread Drive	
TRI-WING	Square Drive	

** Note: to be used with a bit holder

Torx®, Torx Plus® are registered trademarks of Camcar Div., Textron Inc.
 ACR®, Pozidriv®, Torq-Set®, Tri-Wing® are registered trademarks of Phillips Screw Co.

We can propose today a high quality range of bits and sockets with the latest Technology Support and Quality controls.



Bits for precision screw

Drive: \varnothing 3mm Hex drive

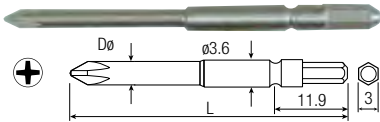

PH	D \varnothing		LENGTH L		PART NO
	mm	in	mm	in	
0	2.5	0.10	50	1.97	615 820 227 0
1	4.0	0.16	50	1.97	615 820 228 0

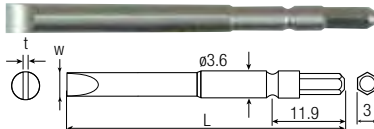

W	t		LENGTH L		PART NO
	mm	in	mm	in	
3	0.5	0.02	50	1.97	615 820 232 0*
4	0.8	0.03	50	1.97	615 820 236 0

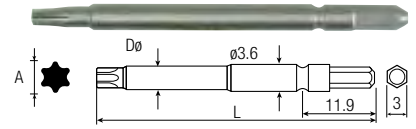

T	A		D \varnothing		LENGTH L		PART NO
	mm	in	mm	in	mm	in	
T6	1.7	0.06	2.2	0.09	50	1.97	615 820 240 0
T10	2.7	0.11	3.0	0.12	50	1.97	615 820 243 0

* Production upon your order.

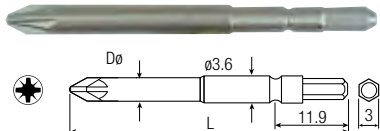

PZ	D \varnothing		LENGTH L		PART NO
	mm	in	mm	in	
0	3	0.12	50	1.97	615 820 238 0
1	4	0.16	50	1.97	615 820 239 0

Drive: 5/16" = 8mm Hex drive

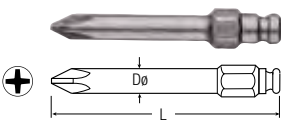

PH	D \varnothing		LENGTH L		PART NO
	mm	in	mm	in	
1	4.5	0.18	50	1.97	615 820 645 0
2	6.0	0.24	50	1.97	615 820 646 0
2	-	-	93	3.66	615 820 721 0
3	-	-	93	3.66	615 820 722 0

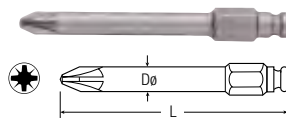

PZ	D \varnothing		LENGTH L		PART NO
	mm	in	mm	in	
1	-	-	92	3.62	615 820 724 0
2	6.0	0.24	50	1.97	615 820 647 0
2	6.0	0.24	92	3.62	615 820 355 0

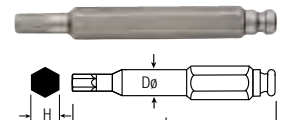

H	D \varnothing		LENGTH L		PART NO
	mm	in	mm	in	
H4	6.0	0.24	50	1.97	615 820 328 0*
H5	8.0	0.31	50	1.97	615 820 329 0
H6	8.0	0.31	50	1.97	615 820 330 0
H8	8.0	0.31	50	1.97	615 820 331 0*

* Production upon your order.

Drive: 11mm Hex drive

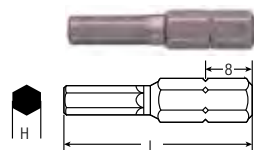

H	LENGTH L		PART NO
	mm	in	
H6	70	2.76	615 820 650 0

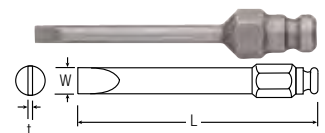

W	t		LENGTH L		PART NO
	mm	in	mm	in	
3	0.5	0.02	76	2.99	615 820 209 0
8.8	1.3	0.05	52	2.05	615 820 728 0

Bits for precision screw

Drive: \varnothing 4mm shank drive - Wing shank

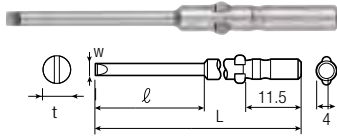

W	t	l	LENGTH	L	TOOLS	PART NO
mm	in	mm	in	mm	in	10 pcs
2	0.3	0.01	20	0.79	40	1.57 SLB001 615 820 423 0
2.5	0.3	0.01	20	0.79	40	1.57 SLB001 615 820 424 0
3	0.4	0.02	20	0.79	40	1.57 SLB001 615 820 048 0
4	0.5	0.02	-	-	40	1.57 SLB001 615 820 425 0

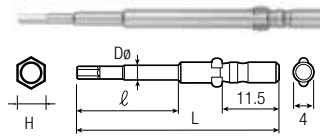

H	Dø	l	LENGTH	L	TOOLS	PART NO
mm	in	mm	in	mm	in	10 pcs
H1.5	2	0.08	20	0.79	60	2.36 SLB001 615 820 426 0
H2	3	0.12	20	0.79	60	2.36 SLB001 615 820 427 0
H2.5	3	0.12	20	0.79	60	2.36 SLB001 615 820 428 0
H3	4	0.16	-	-	60	2.36 SLB001 615 820 429 0

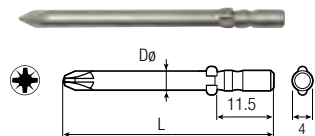

PZ	Dø	LENGTH	L	TOOLS	PART NO
mm	in	mm	in		10 pcs
0	4	0.16	60	2.36	SLB001 615 820 369 0
1	4	0.16	60	2.36	SLB001 615 820 370 0
2	4	0.16	60	2.36	SLB001 615 820 383 0

Drive: \varnothing 4mm shank drive - Wing shank

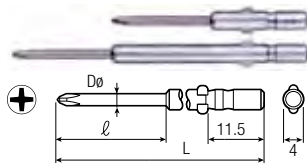

PH	Dø	l	LENGTH	L	TOOLS	PART NO
mm	in	mm	in	mm	in	10 pcs
00	1.2	0.05	20	0.79	40	1.57 ERXS / SLB001 615 820 027 0
00	1.5	0.06	20	0.79	40	1.57 ERXS / SLB001 615 820 412 0
00	1.5	0.06	20	0.79	60	2.36 SLB001 615 820 413 0
00	2.0	0.08	20	0.79	40	1.57 ERXS / SLB001 615 820 414 0
00	2.0	0.08	20	0.79	60	2.36 SLB001 615 820 415 0
0	1.4	0.06	20	0.79	40	1.57 ERXS / SLB001 615 820 028 0
0	1.4	0.06	20	0.79	60	2.36 SLB001 615 820 029 0
0	1.7	0.07	20	0.79	40	1.57 ERXS / SLB001 615 820 416 0
0	1.7	0.07	20	0.79	60	2.36 ERXS / SLB001 615 820 417 0
0	2.0	0.08	20	0.79	40	1.57 ERXS / SLB001 615 820 030 0
0	2.0	0.08	20	0.79	60	2.36 ERXS / SLB001 615 820 031 0
0	2.0	0.08	20	0.79	80	3.15 ERXS / SLB001 615 820 032 0
0	2.0	0.08	20	0.79	100	3.94 SLB001 615 820 033 0
0	2.5	0.10	20	0.79	40	1.57 ERXS / SLB001 615 820 418 0
0	2.5	0.10	20	0.79	60	2.36 ERXS / SLB001 615 820 419 0
0	2.5	0.10	20	0.79	80	3.15 SLB001 615 820 034 0
0	2.5	0.10	20	0.79	100	3.94 SLB001 615 820 035 0
1	3.0	0.12	20	0.79	40	1.57 SLB001 615 820 420 0
1	3.0	0.12	20	0.79	60	2.36 ERXS / SLB001 615 820 036 0
1	3.0	0.12	20	0.79	80	3.15 SLB001 615 820 037 0
1	3.0	0.12	20	0.79	100	3.94 SLB001 615 820 038 0
1	3.0	0.12	20	0.79	120	4.72 SLB001 615 820 442 0
1	4.0	0.16	-	-	40	1.57 SLB001 615 820 421 0
1	4.0	0.16	-	-	60	2.36 SLB001 615 820 039 0
2	4.0	0.16	-	-	40	1.57 SLB001 615 820 422 0
2	4.0	0.16	-	-	60	2.36 ERXS / SLB001 615 820 040 0
2	4.0	0.16	-	-	80	3.15 SLB001 615 820 041 0
2	4.0	0.16	-	-	100	3.94 SLB001 615 820 042 0
2	4.0	0.16	-	-	120	4.72 SLB001 615 820 043 0

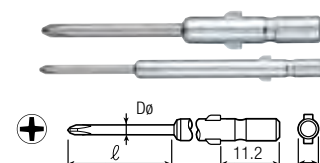

Shockless Bit

PH	Dø	l	LENGTH	L	TOOLS	PART NO
mm	in	mm	in	mm	in	10 pcs
00	1.5	0.06	20	0.79	40	1.57 ERXS / SLB001 615 820 390 0
00	1.5	0.06	20	0.79	60	2.36 ERXS / SLB001 615 820 391 0
0	1.5	0.06	20	0.79	40	1.57 ERXS / SLB001 615 820 392 0
0	1.5	0.06	20	0.79	60	2.36 ERXS / SLB001 615 820 393 0
0	1.7	0.07	20	0.79	40	1.57 ERXS / SLB001 615 820 394 0
0	1.7	0.07	20	0.79	60	2.36 ERXS / SLB001 615 820 395 0
0	2	0.08	20	0.79	40	1.57 ERXS / SLB001 615 820 396 0
0	2	0.08	20	0.79	60	2.36 ERXS / SLB001 615 820 397 0

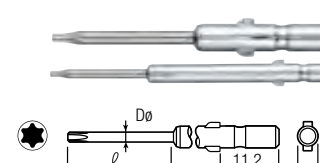

Shockless Bit

T	Dø	l	LENGTH	L	TOOLS	PART NO
mm	in	mm	in	mm	in	10 pcs
T5	2	0.08	20	0.79	40	1.57 ERXS / SLB001 615 820 398 0
T5	2	0.08	20	0.79	60	2.36 ERXS / SLB001 615 820 399 0
T6	2	0.08	20	0.79	40	1.57 ERXS / SLB001 615 820 400 0
T6	2	0.08	20	0.79	60	2.36 ERXS / SLB001 615 820 401 0

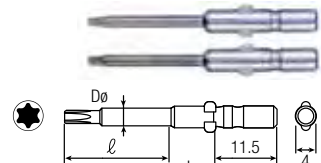

T	Dø	l	LENGTH	L	TOOLS	PART NO
mm	in	mm	in	mm	in	10 pcs
T1	1.5	0.06	20	0.79	40	1.57 SLB001 615 820 670 0
T2	1.5	0.06	20	0.79	40	1.57 SLB001 615 820 671 0
T3	1.7	0.07	20	0.79	40	1.57 SLB001 615 820 672 0
T4	1.8	0.07	20	0.79	40	1.57 ERXS / SLB001 615 820 673 0
T5	2.0	0.08	20	0.79	40	1.57 SLB001 615 820 049 0
T5	2.0	0.08	20	0.79	60	2.36 SLB001 615 820 050 0
T6	2.0	0.08	20	0.79	40	1.57 ERXS / SLB001 615 820 051 0
T6	2.0	0.08	20	0.79	60	2.36 ERXS / SLB001 615 820 052 0
T7	2.0	0.08	20	0.79	60	2.36 SLB001 615 820 053 0
T8	3.0	0.12	20	0.79	40	1.57 SLB001 615 820 674 0
T8H	4.0	0.16	-	-	60	2.36 SLB001 615 820 054 0
T9	3.0	0.12	20	0.79	40	1.57 ERXS / SLB001 615 820 675 0
T10	3.0	0.12	20	0.79	40	1.57 ERXS / SLB001 615 820 676 0
T10H	4.0	0.16	-	-	60	2.36 ERXS / SLB001 615 820 055 0

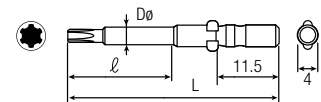

Torx Plus

IP	Dø	l	LENGTH	L	TOOLS	PART NO
mm	in	mm	in	mm	in	10 pcs
4IP	1.8	0.07	20	0.79	60	2.36 ERXS / SLB001 615 820 371 0
5IP	2.0	0.08	20	0.79	60	2.36 ERXS / SLB001 615 820 372 0
6IP	2.5	0.10	20	0.79	60	2.36 ERXS / SLB001 615 820 373 0
8IP	3.0	0.12	20	0.79	60	2.36 ERXS / SLB001 615 820 374 0
10IP	3.0	0.12	20	0.79	60	2.36 ERXS / SLB001 615 820 375 0

Bits for precision screw

Drive: \varnothing 4mm - Halfmoon

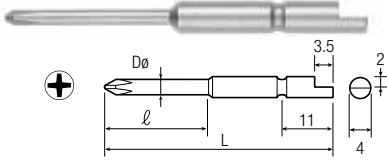

PH	Dø		l		LENGTH L		PART NO
	mm	in	mm	in	mm	in	
00	1.5	0.06	20	0.79	44	1.73	615 820 406 0
00	1.5	0.06	20	0.79	64	2.52	615 820 407 0
00	2.0	0.08	20	0.79	64	2.52	615 820 078 0
0	1.8	0.07	20	0.79	44	1.73	615 820 076 0
0	1.8	0.07	20	0.79	64	2.52	615 820 077 0
0	2.0	0.08	20	0.79	44	1.73	615 820 408 0
0	2.0	0.08	20	0.79	64	2.52	615 820 409 0
0	2.5	0.10	20	0.79	44	1.73	615 820 079 0
0	2.5	0.10	20	0.79	64	2.52	615 820 080 0
1	3.0	0.12	20	0.79	44	1.73	615 820 410 0
1	3.0	0.12	20	0.79	64	2.52	615 820 411 0
1	4.0	0.16	20	0.79	44	1.73	615 820 081 0
1	4.0	0.16	20	0.79	64	2.52	615 820 082 0
2	4.0	0.16	20	0.79	44	1.73	615 820 083 0
2	4.0	0.16	20	0.79	64	2.52	615 820 084 0

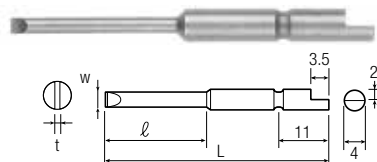

w	t	l		LENGTH L		PART NO	
		mm	in	mm	in		10 pcs
2	0.3	0.01	20	0.79	44	1.73	615 820 086 0
2.5	0.3	0.01	20	0.79	44	1.73	615 820 087 0
3	0.4	0.02	20	0.79	44	1.73	615 820 088 0
4	0.5	0.02	-	-	44	1.73	615 820 089 0

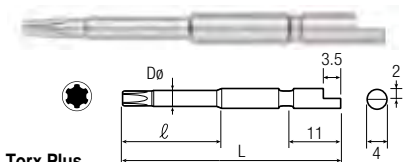

Torx Plus

IP	Dø		l		LENGTH L		PART NO
	mm	in	mm	in	mm	in	
2IP	1.5	0.06	20	0.79	44	1.73	615 820 381 0
2IP	1.5	0.06	20	0.79	64	2.52	615 820 367 0
3IP	1.7	0.07	20	0.79	44	1.73	615 820 382 0
3IP	1.7	0.07	20	0.79	64	2.52	615 820 368 0
4IP	1.8	0.07	20	0.79	44	1.73	615 820 357 0
4IP	1.8	0.07	20	0.79	64	2.52	615 820 358 0
5IP	2.0	0.08	20	0.79	44	1.73	615 820 359 0
5IP	2.0	0.08	20	0.79	64	2.52	615 820 360 0
6IP	2.5	0.10	20	0.79	44	1.73	615 820 361 0
6IP	2.5	0.10	20	0.79	64	2.52	615 820 362 0
8IP	3.0	0.12	20	0.79	44	1.73	615 820 363 0
8IP	3.0	0.12	20	0.79	64	2.52	615 820 364 0
10IP	3.0	0.12	20	0.79	44	1.73	615 820 365 0
10IP	3.0	0.12	20	0.79	64	2.52	615 820 366 0

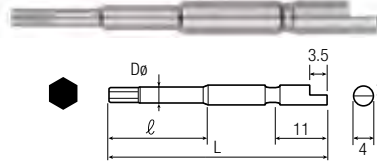

H	Dø		l		LENGTH L		PART NO
	mm	in	mm	in	mm	in	
H1.5	2.0	0.08	20	0.79	44	1.73	615 820 091 0
H2	3.0	0.12	20	0.79	44	1.73	615 820 092 0
H2.5	3.0	0.12	20	0.79	44	1.73	615 820 093 0
H3	4.0	0.16	-	-	44	1.73	615 820 094 0

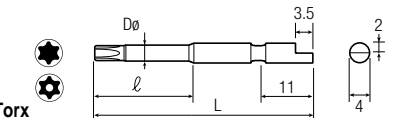

Torx Torx Taper Proof

T	Dø		l		LENGTH L		PART NO
	mm	in	mm	in	mm	in	
T1	1.5	0.06	20	0.79	44	1.73	615 820 663 0
T2	1.5	0.06	20	0.79	44	1.73	615 820 664 0
T3	1.7	0.07	20	0.79	44	1.73	615 820 665 0
T4	1.8	0.07	20	0.79	44	1.73	615 820 666 0
T5	2.0	0.08	20	0.79	44	1.73	615 820 102 0
T5	2.0	0.08	20	0.79	64	2.52	615 820 103 0
T6	2.0	0.08	20	0.79	44	1.73	615 820 104 0
T6	2.0	0.08	20	0.79	64	2.52	615 820 105 0
T8	3.0	0.12	20	0.79	44	1.73	615 820 668 0
T8H	3.0	0.12	20	0.79	44	1.73	615 820 106 0
T8H	3.0	0.12	20	0.79	64	2.52	615 820 107 0
T9	3.0	0.12	20	0.79	44	1.73	615 820 669 0
T10H	3.0	0.12	20	0.79	44	1.73	615 820 108 0
T10H	3.0	0.12	20	0.79	64	2.52	615 820 109 0
T15H	4.0	0.16	20	0.79	64	2.52	615 820 110 0

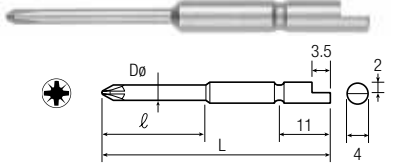

PZ	Dø		l		LENGTH L		PART NO
	mm	in	mm	in	mm	in	
0	2.5	0.10	20	0.79	44	1.73	615 820 377 0
0	2.5	0.10	20	0.79	64	2.52	615 820 378 0
1	4.0	0.16	-	-	44	1.73	615 820 379 0
1	4.0	0.16	-	-	64	2.52	615 820 380 0

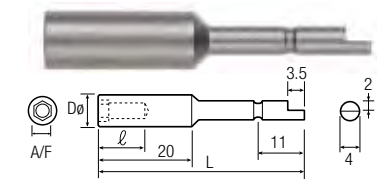

AF	Dø		l		LENGTH L		PART NO
	mm	in	mm	in	mm	in	
AF2.3	4.0	0.16	5	0.20	44	1.73	615 820 095 0
AF2.5	4.0	0.16	5	0.20	44	1.73	615 820 096 0
AF3	5.0	0.20	8	0.31	44	1.73	615 820 097 0
AF4	7.0	0.28	10	0.39	44	1.73	615 820 098 0
AF4.5	7.0	0.28	10	0.39	44	1.73	615 820 099 0
AF5	8.0	0.31	15	0.59	44	1.73	615 820 100 0
AF5.5	8.0	0.31	15	0.59	44	1.73	615 820 101 0

Insert bits

Drive: 1/4" = 6.35mm
Hex shank DIN3126-C6.3

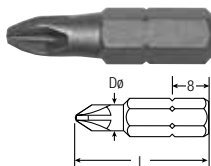

PH	Dø		LENGTH L		PART NO
	mm	in	mm	in	
2	6.0	0.24	25.4	1.00	615 820 518 0

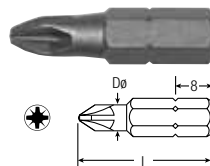

PZ	Dø		LENGTH L		PART NO
	mm	in	mm	in	
1	4.5	0.18	25.0	0.98	615 820 690 0
2	6.0	0.24	25.0	0.98	615 820 450 0
2	6.0	0.24	50.0	1.97	615 820 694 0
3	6.0	0.24	25.0	0.98	615 820 693 0

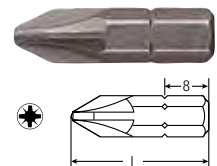

PZ	LENGTH L		PART NO
	mm	in	
1	25.4	1.00	615 820 449 0
2	25.4	1.00	615 820 450 0
3	50.0	1.97	615 820 522 0

Insert bits

Drive: 1/4" = 6.35mm
Hex shank DIN3126-C6.3

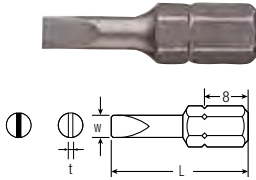

w	t	LENGTH L		PART NO
mm	in	mm	in	10 pcs
4	0.6	0.02	25.0 0.98	615 820 531 0
5	0.8	0.03	25.0 0.98	615 820 532 0

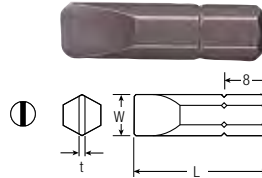

w	t	LENGTH L		PART NO
mm	in	mm	in	10 pcs
4.76	0.9	0.03	25.4 1.00	615 820 452 0
5.55	1.0	0.04	25.4 1.00	615 820 453 0
6.35	1.1	0.04	25.4 1.00	615 820 454 0
7.14	1.2	0.05	25.4 1.00	615 820 455 0
7.93	1.3	0.05	25.4 1.00	615 820 456 0

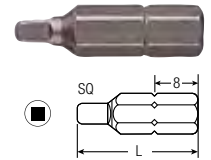

SQ	LENGTH L		PART NO
	mm	in	10 pcs
1 (3/32")	25.4	1.00	615 820 461 0*
2 (1/8")	25.4	1.00	615 820 462 0
3 (9/64")	25.4	1.00	615 820 463 0

* Production upon your order.

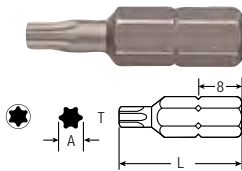

T	A	LENGTH L		PART NO
mm	in	mm	in	10 pcs
T3	1.1	0.04	25.0 0.98	615 820 686 0
T5	1.4	0.05	25.0 0.98	615 820 537 0
T6	1.7	0.06	25.0 0.98	615 820 538 0
T7	2.0	0.08	25.0 0.98	615 820 539 0
T8	2.3	0.09	25.0 0.98	615 820 540 0
T9	2.5	0.10	25.0 0.98	615 820 541 0
T10	2.7	0.11	25.0 0.98	615 820 542 0
T15	3.3	0.13	25.0 0.98	615 820 543 0
T20	3.8	0.15	25.0 0.98	615 820 544 0
T25	4.4	0.17	25.0 0.98	615 820 545 0
T27	5.0	0.20	25.0 0.98	615 820 546 0
T30	5.5	0.22	25.0 0.98	615 820 547 0
T40	6.6	0.26	25.0 0.98	615 820 548 0

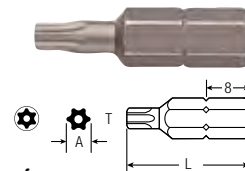

Torx Tamper Proof

T	A	LENGTH L		PART NO
mm	in	mm	in	10 pcs
T10H	2.7	0.11	25.0 0.98	615 820 549 0
T20H	3.8	0.15	25.0 0.98	615 820 551 0
T25H	4.4	0.17	25.0 0.98	615 820 552 0
T27H	5.0	0.20	25.0 0.98	615 820 553 0*

* Production upon your order.

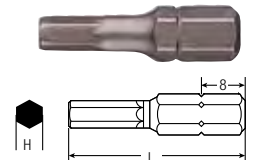

H	LENGTH L		PART NO
mm	in	10 pcs	
H1.5	25.0	0.98	615 820 523 0
H2	25.0	0.98	615 820 524 0
H2.5	25.0	0.98	615 820 525 0
H3	25.0	0.98	615 820 526 0
H4	25.0	0.98	615 820 527 0
H5	25.0	0.98	615 820 528 0
H6	25.0	0.98	615 820 529 0
H8	25.0	0.98	615 820 530 0

Drive: 5/16" = 8mm Hex.
DIN3126-C8

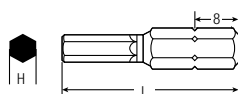

H	LENGTH L		PART NO
mm	in	10 pcs	
H5	34.0	1.34	615 820 533 0
H6	34.0	1.34	615 820 534 0



Torx Plus

IP	A	LENGTH L		PART NO
mm	in	mm	in	10 pcs
6IP	1.7	0.06	25.0 0.98	615 820 257 0
8IP	2.3	0.09	25.0 0.98	615 820 258 0
10IP	2.7	0.11	25.0 0.98	615 820 259 0
15IP	3.3	0.13	25.0 0.98	615 820 260 0
20IP	3.8	0.15	25.0 0.98	615 820 261 0
25IP	4.4	0.17	25.0 0.98	615 820 262 0
30IP	5.5	0.22	25.0 0.98	615 820 263 0
40IP	6.6	0.26	25.4 1.00	615 820 264 0

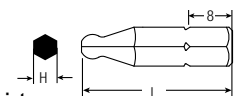

Ball Point

H	LENGTH L		PART NO
mm	in	10 pcs	
H2	25.0	0.98	615 820 114 0
H2.5	25.0	0.98	615 820 115 0
H3	25.0	0.98	615 820 116 0
H4	25.0	0.98	615 820 117 0
H5	25.0	0.98	615 820 118 0
H6	25.0	0.98	615 820 119 0
H8	25.0	0.98	615 820 120 0



Power bits

Drive: 1/4" = 6.35mm
Hex drive - DIN3126-E6.3

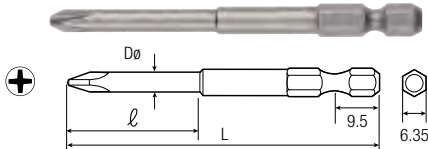
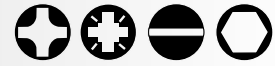

PH	Dø		l		LENGTH L		PART NO
	mm	in	mm	in	mm	in	
00	1.2	0.05	20	0.8	60	2.4	615 820 056 0
00	1.6	0.06	-	-	49	1.9	615 820 125 0
00	1.6	0.06	-	-	70	2.8	615 820 348 0
00	1.5	0.06	20	0.8	60	2.4	615 820 057 0
00	1.7	0.07	20	0.8	60	2.4	615 820 058 0
00	2	0.08	40	1.57	60	2.36	615 820 059 0
0	1.4	0.06	30	1.2	60	2.4	615 820 061 0
0	1.7	0.07	40	1.6	80	3.1	615 820 064 0
0	2.5	0.10	20	0.8	60	2.4	615 820 067 0
0	2.5	0.10	30	1.2	100	3.9	615 820 068 0
0	3.0	0.12	20	0.8	60	2.4	615 820 069 0
0	3.0	0.12	30	1.2	100	3.9	615 820 070 0
0	3.2	0.12	-	-	49	1.9	615 820 464 0

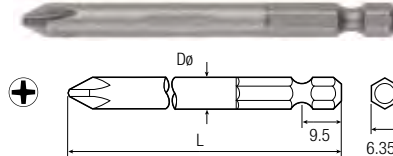

PH	Dø		LENGTH L		PART NO
	mm	in	mm	in	
1	4.8	0.19	49	1.93	615 820 465 0
1	4.76	0.19	70	2.76	615 820 466 0
1	4.76	0.19	89	3.50	615 820 467 0
1	4.5	0.18	150	5.91	615 820 659 0
1	4.76	0.19	152	5.98	615 820 468 0
2	4.76	0.19	49	1.93	615 820 126 0
2	6.35	0.25	49	1.93	615 820 469 0
2	6.35	0.25	70	2.76	615 820 470 0
2	6.35	0.25	89	3.50	615 820 471 0
2	6.0	0.24	100	3.94	615 820 561 0
2	6.0	0.24	127	5.00	615 820 127 0
2	6.0	0.24	150	5.91	615 820 660 0
2	6.35	0.25	152	5.98	615 820 472 0
2	6.0	0.24	200	7.87	615 820 129 0
3	7.9	0.31	70	2.76	615 820 474 0
3	7.9	0.31	89	3.50	615 820 475 0
3	8.0	0.31	150	5.91	615 820 128 0

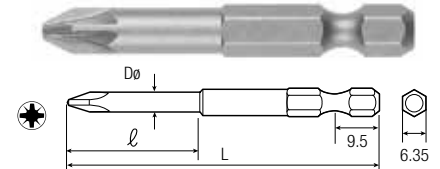

PZ	Dø		l		LENGTH L		PART NO
	mm	in	mm	in	mm	in	
0	3.17	0.12	-	-	70	2.76	615 820 314 0
0	2.00	0.08	20	0.79	60	2.36	615 820 715 0
0	3.00	0.12	20	0.79	60	2.36	615 820 716 0
0	2.0	0.08	30	1.18	100	3.94	615 820 322 0
1	4.76	0.19	-	-	49	1.93	615 820 131 0
1	4.76	0.19	-	-	70	2.76	615 820 352 0
1	4.76	0.19	-	-	89	3.50	615 820 478 0
1	4.50	0.18	-	-	100	3.94	615 820 483 0
1	4.76	0.19	50	1.97	152	5.98	615 820 481 0
2	6.35	0.25	-	-	49	1.93	615 820 311 0
2	6.0	0.24	22	0.87	50	1.97	615 820 712 0
2	6.35	0.25	-	-	70	2.76	615 820 476 0
2	6.35	0.25	-	-	89	3.50	615 820 479 0
2	6.0	0.24	-	-	100	3.94	615 820 558 0
2	6.0	0.24	-	-	150	5.91	615 820 661 0
2	6.35	0.25	50	1.97	152	5.98	615 820 482 0
2	6.0	0.24	-	-	200	7.87	615 820 711 0
4	8.0	0.31	-	-	51	2.01	615 820 714 0

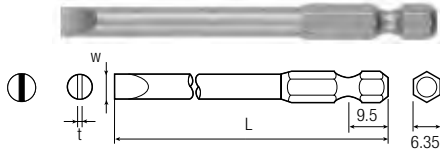

W	t		LENGTH L		PART NO
	mm	in	mm	in	
3.0	0.50	0.02	51	2.01	615 820 566 0
3.4	0.66	0.03	70	2.76	615 820 135 0
3.8	0.76	0.03	76	2.99	615 820 137 0
4.0	0.60	0.02	51	2.01	615 820 567 0
4.75	0.86	0.03	76	2.99	615 820 138 0
5.5	0.80	0.03	51	2.01	615 820 568 0
6.35	0.91	0.04	49	1.93	615 820 489 0
3.1	0.56	0.02	102	4.02	615 820 144 0
3.1	0.56	0.02	76	2.99	615 820 136 0
3.1	0.56	0.02	49	1.93	615 820 132 0
9.1	1.27	0.05	102	4.02	615 820 152 0
4.75	0.86	0.03	102	4.02	615 820 147 0
3.8	0.55	0.02	102	4.02	615 820 146 0
3.4	1.27	0.05	102	4.02	615 820 145 0
9.1	1.17	0.05	76	2.99	615 820 143 0
7.9	1.067	0.04	76	2.99	615 820 142 0
6.98	0.96	0.04	76	2.99	615 820 141 0
5.46	1.27	0.05	76	2.99	615 820 139 0
9.1	1.17	0.05	49	1.93	615 820 493 0
7.9	1.067	0.04	49	1.93	615 820 492 0
6.98	0.96	0.04	49	1.93	615 820 491 0
6.35	0.91	0.04	49	1.93	615 820 490 0
5.46	0.86	0.03	49	1.93	615 820 488 0
3.8	0.55	0.02	49	1.93	615 820 134 0
3.4	0.66	0.03	49	1.93	615 820 133 0

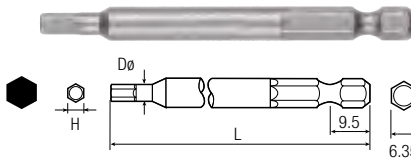

H	Dø		LENGTH L		PART NO
	mm	in	mm	in	
H2	7.0	0.28	75	2.95	615 820 001 0
H2	7.0	0.28	100	3.94	615 820 002 0
H2	3.5	0.14	49	1.93	615 820 353 0
H2.5	7.0	0.28	75	2.95	615 820 003 0
H2.5	7.0	0.28	100	3.94	615 820 004 0
H2.5	7.0	0.28	150	5.91	615 820 014 0
H2.5	3.5	0.14	49	1.93	615 820 495 0
H3	3.5	0.14	49	1.93	615 820 496 0
H3	7.0	0.28	75	2.95	615 820 005 0
H3	7.0	0.28	100	3.94	615 820 006 0
H3	7.0	0.28	150	5.91	615 820 015 0
H4	4.6	0.18	49	1.93	615 820 497 0
H4	7.0	0.28	75	2.95	615 820 007 0
H4	7.0	0.28	100	3.94	615 820 008 0
H4	7.0	0.28	150	5.91	615 820 016 0
H5	5.8	0.23	49	1.93	615 820 498 0
H5	7.0	0.28	75	2.95	615 820 009 0
H5	7.0	0.28	100	3.94	615 820 010 0
H5	7.0	0.28	150	5.91	615 820 017 0

H	Dø		LENGTH L		PART NO
	mm	in	mm	in	
H6	-	-	49	1.93	615 820 499 0
H6	7.0	0.28	75	2.95	615 820 011 0
H6	7.0	0.28	100	3.94	615 820 012 0
H6	7.0	0.28	150	5.91	615 820 018 0
H7	10	0.39	70	2.76	615 820 569 0
H8	-	-	49	1.93	615 820 315 0
H8	10	0.39	70	2.76	615 820 570 0
H8	10	0.39	150	5.91	615 820 019 0
H9	11	0.43	70	2.76	615 820 571 0
H10	-	-	49	1.93	615 820 354 0
H10	12	0.47	70	2.76	615 820 572 0
H1/4"	-	-	49	1.93	615 820 494 0

Power bits

Drive: 1/4" = 6.35mm
Hex drive - DIN3126-E6.3

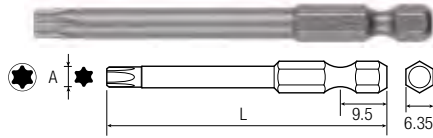

T	A		LENGTH L		PART NO
	mm	in	mm	in	
T5	1.37	0.05	49	1.93	615 820 153 0
T5	1.37	0.05	70	2.76	615 820 154 0
T6	1.65	0.06	49	1.93	615 820 156 0
T6	1.65	0.06	70	2.76	615 820 157 0
T7	1.97	0.08	70	2.76	615 820 161 0
T7	1.97	0.08	89	3.50	615 820 162 0
T8	2.30	0.09	49	1.93	615 820 166 0
T8	2.30	0.09	70	2.76	615 820 167 0
T8	2.30	0.09	90	3.54	615 820 168 0
T8	2.30	0.09	152	5.98	615 820 169 0
T9	2.48	0.10	70	2.76	615 820 171 0
T9	2.48	0.10	90	3.54	615 820 172 0
T9	2.48	0.10	152	5.98	615 820 176 0
T10	2.72	0.11	49	1.93	615 820 177 0
T10	2.72	0.11	70	2.76	615 820 178 0
T10	2.72	0.11	90	3.54	615 820 179 0
T10	2.72	0.11	152	5.98	615 820 180 0
T15	3.26	0.13	49	1.93	615 820 181 0
T15	3.26	0.13	70	2.76	615 820 183 0
T15	3.26	0.13	90	3.54	615 820 186 0
T15	3.26	0.13	152	5.98	615 820 187 0*
T20	3.84	0.15	49	1.93	615 820 188 0
T20	3.84	0.15	70	2.76	615 820 189 0
T20	3.84	0.15	90	3.54	615 820 190 0
T20	3.84	0.15	152	5.98	615 820 191 0
T25	4.40	0.17	49	1.93	615 820 192 0
T25	4.40	0.17	70	2.76	615 820 193 0
T25	4.40	0.17	152	5.98	615 820 316 0*
T27	4.96	0.20	90	3.54	615 820 356 0
T27	4.96	0.20	152	5.98	615 820 695 0
T30	5.49	0.22	49	1.93	615 820 163 0
T30	5.49	0.22	70	2.76	615 820 174 0
T30	5.49	0.22	90	3.54	615 820 184 0
T30	5.49	0.22	152	5.98	615 820 194 0
T40	6.60	0.26	49	1.93	615 820 164 0
T40	6.60	0.26	70	2.76	615 820 175 0
T40	6.60	0.26	90	3.54	615 820 185 0
T40	6.60	0.26	152	5.98	615 820 195 0

* Production upon your order.

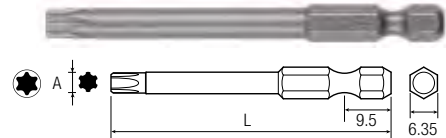

Torx Plus

IP	A		LENGTH L		PART NO
	mm	in	mm	in	
5IP	1.37	0.05	49	1.93	615 820 265 0
5IP	1.37	0.05	70	2.76	615 820 266 0
6IP	1.65	0.06	152	5.98	615 820 270 0
7IP	1.97	0.08	49	1.93	615 820 271 0
7IP	1.97	0.08	70	2.76	615 820 272 0
7IP	1.97	0.08	90	3.54	615 820 273 0
7IP	1.97	0.08	152	5.98	615 820 274 0
8IP	2.30	0.09	49	1.93	615 820 275 0
8IP	2.30	0.09	90	3.54	615 820 277 0
8IP	2.30	0.09	152	5.98	615 820 278 0
9IP	2.48	0.10	49	1.93	615 820 280 0
9IP	2.48	0.10	70	2.76	615 820 281 0*
9IP	2.48	0.10	90	3.54	615 820 286 0*
9IP	2.48	0.10	152	5.98	615 820 279 0*
10IP	2.72	0.11	49	1.93	615 820 287 0
10IP	2.72	0.11	152	5.98	615 820 294 0
15IP	3.26	0.13	49	1.93	615 820 295 0
15IP	3.26	0.13	90	3.54	615 820 301 0*
15IP	3.26	0.13	152	5.98	615 820 302 0
20IP	3.84	0.15	49	1.93	615 820 303 0
20IP	3.84	0.15	70	2.76	615 820 304 0
20IP	3.84	0.15	90	3.54	615 820 305 0*
20IP	3.84	0.15	152	5.98	615 820 306 0
25IP	4.40	0.17	49	1.93	615 820 282 0*
25IP	4.40	0.17	70	2.76	615 820 283 0*
25IP	4.40	0.17	90	3.54	615 820 284 0*
25IP	4.40	0.17	152	5.98	615 820 285 0*
27IP	4.96	0.20	49	1.93	615 820 289 0
27IP	4.96	0.20	90	3.54	615 820 291 0*
30IP	5.49	0.22	49	1.93	615 820 297 0*
30IP	5.49	0.22	70	2.76	615 820 298 0*
30IP	5.49	0.22	90	3.54	615 820 299 0*
30IP	5.49	0.22	152	5.98	615 820 300 0
40IP	6.60	0.26	49	1.93	615 820 307 0*
40IP	6.60	0.26	70	2.76	615 820 308 0*
40IP	6.60	0.26	90	3.54	615 820 309 0*
40IP	6.60	0.26	152	5.98	615 820 310 0

* Production upon your order.

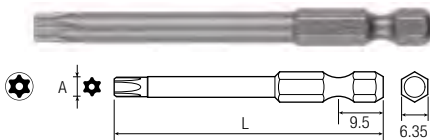

Torx Tamper Proof

T	A		LENGTH L		PART NO
	mm	in	mm	in	
T10H	2.72	0.11	49	1.93	615 820 196 0
T10H	2.72	0.11	70	2.76	615 820 198 0
T20H	3.84	0.15	49	1.93	615 820 197 0
T20H	3.84	0.15	70	2.76	615 820 199 0

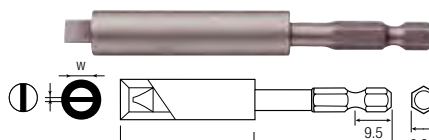

Finder Sleeve Combined

W	t		screw head	LENGTH L		PART NO
	mm	in		mm	in	
4.90	0.91	0.04	4-5	95	3.74	111062
0.91	0.91	0.04	5-6	95	3.74	615 820 503 0
6.12	0.97	0.04	6-8	95	3.74	111072
7.37	1.07	0.04	8-10	95	3.74	615 804 741 0
8.89	1.17	0.05	10-12	95	3.74	615 804 742 0
10.03	1.27	0.05	12-14	98	3.86	615 804 743 0

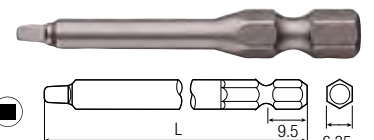

SQ	LENGTH L		PART NO
	mm	in	
1 (3/32")	70	2.76	615 820 500 0
3 (9/64")	70	2.76	615 820 502 0



Nut setters

Drive: 1/4" = 6.35mm
Hex drive - DIN3126-E6.3



Non magnetic nut setters

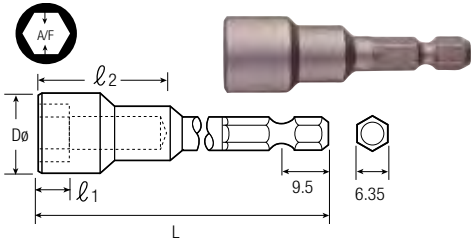

A/F		Dø		I1		I2		LENGTH L		PART NO
mm	in	mm	in	mm	in	mm	in	mm	in	10 pcs
4.0	0.2	8.0	0.3	3.0	0.1	15.0	0.6	50	2.0	615 820 573 0
4.0	0.2	8.0	0.3	3.0	0.1	25.0	1.0	100	3.9	615 820 599 0
4.5	0.2	8.0	0.3	3.0	0.1	15.0	0.6	50	2.0	615 820 574 0*
4.5	0.2	8.0	0.3	3.0	0.1	25.0	1.0	100	3.9	615 820 600 0
5.0	0.2	8.5	0.3	3.5	0.1	15.0	0.6	50	2.0	615 820 575 0*
5.0	0.2	8.5	0.3	3.5	0.1	25.0	1.0	75	3.0	615 820 588 0
5.0	0.2	8.5	0.3	3.5	0.1	25.0	1.0	100	3.9	615 820 601 0
5.0	0.2	8.5	0.3	3.5	0.1	25.0	1.0	150	5.9	615 820 210 0
5.5	0.2	9.0	0.4	3.5	0.1	15.0	0.6	50	2.0	615 820 576 0
5.5	0.2	9.0	0.4	3.5	0.1	25.0	1.0	75	3.0	615 820 589 0
5.5	0.2	9.0	0.4	3.5	0.1	25.0	1.0	100	3.9	615 820 602 0
5.5	0.2	9.0	0.4	3.5	0.1	25.0	1.0	150	5.9	615 820 211 0
6.0	0.2	10.0	0.4	4.0	0.2	15.0	0.6	50	2.0	615 820 577 0
6.0	0.2	10.0	0.4	4.0	0.2	25.0	1.0	75	3.0	615 820 590 0
6.0	0.2	10.0	0.4	4.0	0.2	25.0	1.0	100	3.9	615 820 603 0
6.0	0.2	10.0	0.4	4.0	0.2	25.0	1.0	150	5.9	615 820 212 0
7.0	0.3	13.0	0.5	5.0	0.2	15.0	0.6	50	2.0	615 820 578 0
7.0	0.3	13.0	0.5	5.0	0.2	25.0	1.0	75	3.0	615 820 591 0
7.0	0.3	13.0	0.5	5.0	0.2	25.0	1.0	100	3.9	615 820 604 0
7.0	0.3	13.0	0.5	5.0	0.2	25.0	1.0	150	5.9	615 820 213 0
8.0	0.3	13.0	0.5	5.0	0.2	15.0	0.6	50	2.0	615 820 579 0
8.0	0.3	13.0	0.5	5.0	0.2	30.0	1.2	75	3.0	615 820 592 0
8.0	0.3	13.0	0.5	5.0	0.2	30.0	1.2	100	3.9	615 820 605 0
8.0	0.3	13.0	0.5	5.0	0.2	30.0	1.2	150	5.9	615 820 214 0
9.0	0.4	14.0	0.6	5.5	0.2	15.0	0.6	50	2.0	615 820 580 0
9.0	0.4	14.0	0.6	5.5	0.2	30.0	1.2	75	3.0	615 820 593 0
9.0	0.4	14.0	0.6	5.5	0.2	30.0	1.2	100	3.9	615 820 606 0
10.0	0.4	16.0	0.6	6.5	0.3	15.0	0.6	50	2.0	615 820 581 0
10.0	0.4	16.0	0.6	6.5	0.3	30.0	1.2	75	3.0	615 820 594 0
10.0	0.4	16.0	0.6	6.5	0.3	30.0	1.2	100	3.9	615 820 607 0
10.0	0.4	16.0	0.6	6.5	0.3	30.0	1.2	150	5.9	615 820 215 0
11.0	0.4	17.0	0.7	7.0	0.3	15.0	0.6	50	2.0	615 820 582 0
11.0	0.4	17.0	0.7	7.0	0.3	30.0	1.2	75	3.0	615 820 595 0
11.0	0.4	17.0	0.7	7.0	0.3	30.0	1.2	100	3.9	615 820 608 0
12.0	0.5	18.0	0.7	7.5	0.3	30.0	1.2	75	3.0	615 820 596 0
12.0	0.5	18.0	0.7	7.5	0.3	30.0	1.2	100	3.9	615 820 609 0
12.0	0.5	18.0	0.7	7.5	0.3	30.0	1.2	150	5.9	615 820 216 0
13.0	0.5	19.0	0.7	8.0	0.3	15.0	0.6	50	2.0	615 820 584 0
13.0	0.5	19.0	0.7	8.0	0.3	30.0	1.2	100	3.9	615 820 610 0
13.0	0.5	19.0	0.7	8.0	0.3	30.0	1.2	150	5.9	615 820 217 0
14.0	0.6	20.0	0.8	8.0	0.3	15.0	0.6	50	2.0	615 820 585 0
14.0	0.6	20.0	0.8	8.0	0.3	30.0	1.2	75	3.0	615 820 598 0
14.0	0.6	20.0	0.8	8.0	0.3	30.0	1.2	100	3.9	615 820 611 0

Magnetic nut setters

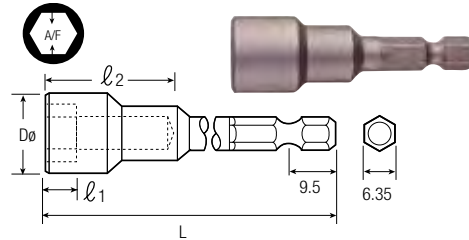

A/F		Dø		I1		LENGTH L		PART NO
mm	in	mm	in	mm	in	mm	in	10 pcs
5.0	0.2	8.5	0.3	3.5	0.1	50	2.0	615 820 612 0
5.0	0.2	8.5	0.3	3.5	0.1	75	3.0	615 820 623 0
5.0	0.2	8.5	0.3	3.5	0.1	100	3.9	615 820 634 0
5.0	0.2	8.5	0.3	3.5	0.1	150	5.9	615 820 218 0
5.5	0.2	9.0	0.4	3.5	0.1	50	2.0	615 820 613 0
5.5	0.2	9.0	0.4	3.5	0.1	75	3.0	615 820 624 0*
6.0	0.2	10.0	0.4	4.0	0.2	50	2.0	615 820 614 0
6.0	0.2	10.0	0.4	4.0	0.2	75	3.0	615 820 625 0
6.0	0.2	10.0	0.4	4.0	0.2	100	3.9	615 820 636 0
6.0	0.2	10.0	0.4	4.0	0.2	150	5.9	615 820 220 0
7.0	0.3	13.0	0.5	4.5	0.2	50	2.0	615 820 615 0
7.0	0.3	13.0	0.5	4.5	0.2	75	3.0	615 820 626 0
7.0	0.3	13.0	0.5	4.5	0.2	100	3.9	615 820 637 0
7.0	0.3	13.0	0.5	5.0	0.2	150	5.9	615 820 221 0
8.0	0.3	13.0	0.5	5.0	0.2	50	2.0	615 820 616 0
8.0	0.3	13.0	0.5	5.0	0.2	75	3.0	615 820 627 0
8.0	0.3	13.0	0.5	5.0	0.2	100	3.9	615 820 638 0
8.0	0.3	13.0	0.5	5.0	0.2	150	5.9	615 820 222 0
9.0	0.4	14.0	0.6	5.5	0.2	50	2.0	615 820 617 0
9.0	0.4	14.0	0.6	5.5	0.2	75	3.0	615 820 628 0
9.0	0.4	14.0	0.6	5.5	0.2	100	3.9	615 820 639 0
10.0	0.4	16.0	0.6	6.5	0.3	50	2.0	615 820 618 0
10.0	0.4	16.0	0.6	6.5	0.3	75	3.0	615 820 629 0
10.0	0.4	16.0	0.6	6.5	0.3	100	3.9	615 820 640 0
10.0	0.4	16.0	0.6	6.5	0.3	150	5.9	615 820 223 0
11.0	0.4	17.0	0.7	7.0	0.3	50	2.0	615 820 619 0
11.0	0.4	17.0	0.7	7.0	0.3	75	3.0	615 820 630 0
11.0	0.4	17.0	0.7	7.0	0.3	100	3.9	615 820 641 0
12.0	0.5	18.0	0.7	7.5	0.3	50	2.0	615 820 620 0
12.0	0.5	18.0	0.7	7.5	0.3	75	3.0	615 820 631 0
12.0	0.5	18.0	0.7	7.5	0.3	100	3.9	615 820 642 0
12.0	0.5	18.0	0.7	7.5	0.3	150	5.9	615 820 224 0
13.0	0.5	19.0	0.7	8.0	0.3	50	2.0	615 820 621 0
13.0	0.5	19.0	0.7	8.0	0.3	75	3.0	615 820 632 0
13.0	0.5	19.0	0.7	8.0	0.3	100	3.9	615 820 643 0
13.0	0.5	19.0	0.7	8.0	0.3	150	5.9	615 820 225 0
14.0	0.6	20.0	0.8	8.0	0.3	50	2.0	615 820 622 0
14.0	0.6	20.0	0.8	8.0	0.3	75	3.0	615 820 633 0
14.0	0.6	20.0	0.8	8.0	0.3	100	3.9	615 820 644 0

* Production upon your order.

Screw shanks

Screw shank driver bit

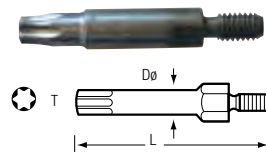

PH	M	LENGTH L	PART NO
		mm in	10 pcs
2	M4	34 1.34	615 820 654 0
2	M5	34 1.34	615 820 657 0

PZ	M	LENGTH L	PART NO
		mm in	10 pcs
2	M5	34 1.34	615 820 658 0

T	M	Dø		LENGTH L		PART NO
		mm	in	mm	in	10 pcs
T10	M4	6	0.24	33	1.3	105782
T20	M4	6	0.24	33	1.3	105802
T15	M5	7	0.28	33	1.3	105842
T20	M5	7	0.28	33	1.3	105852
T25	M5	7	0.28	33	1.3	105862
T30	M5	7	0.28	33	1.3	105882

* Production upon your order.

Adapters

Drive: 1/4" = 6.35mm Hex drive - DIN3126-E6.3

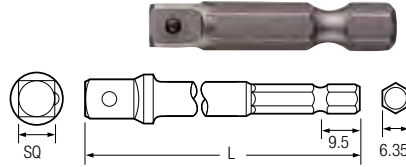

SQ	LENGTH L		PART NO
	mm	in	
1/4"	35	1.38	95352
1/4"	51	2.01	615 820 508 0
1/4"	76	2.99	615 820 509 0
1/4"	102	4.02	615 820 510 0
1/4"	152	5.98	615 820 511 0
3/8"	43	1.69	95362
3/8"	51	2.01	615 820 512 0
3/8"	76	2.99	615 820 513 0
3/8"	102	4.02	615 820 514 0
3/8"	152	5.98	615 820 515 0

Bits holders

Drive: 1/4" = 6.35mm Hex drive - DIN3126-C6.3



	TIP SIZE	LENGTH L		MAGNETIC	PART NO
		mm	in		
⊗	T10	33	1.30	yes	615 820 247 0
⊗	T15	33	1.30	yes	615 820 245 0
⊗	T20	33	1.30	yes	615 820 246 0
⊗	T25	33	1.30	yes	615 820 253 0
⊗	PH1	33	1.30	yes	615 820 248 0
⊗	PH2	33	1.30	yes	615 820 249 0
⊗	PZ1	33	1.30	yes	615 820 250 0
⊗	PZ2	33	1.30	yes	615 820 251 0



TIP SIZE	LENGTH L		PART NO
	mm	in	
T10	49	1.93	615 820 340 0
T10	70	2.76	615 820 341 0
T15	49	1.93	615 820 702 0
T20	49	1.93	615 820 342 0
T20	75	2.95	615 820 343 0
T20	150	5.91	615 820 344 0
T25	49	1.93	615 820 704 0
T25	70	2.76	615 820 705 0

PART NO	TIP SIZE	DRIVE	LENGTH L		DIAMETER Ø		MAGNETIC	DIN 3126-C6.3	DIN 3126-E6.3	DOUBLE ENDED BITS DIN 3126-E6.3	DOUBLE ENDED BITS DIN 3126-C6.3	SPECIFIC BIT
			mm	in	mm	in						
615 820 557 0		5/16"	70	2.8	12.7	0.51	Yes	X				
11502		5/16"	54	2.2	11.1	0.44	Yes	X				
615 820 556 0		5/16"	50	2.0	11.1	0.44	No	X				
615 820 443 0		1/4"	71	2.8	17	0.68	Yes	X				
615 820 404 0		1/4"	60	2.4	11.1	0.44	Yes	X				
615 820 555 0		1/4"	75	3.0	9.1	0.36	Yes			X		
110102		1/4"	150	6.0	11.1	0.44	Yes	X				
615 820 506 0		1/4"	100	4.0	11.1	0.44	Yes	X				
615 820 402 0		1/4"	60	2.4	11.1	0.44	No			X		
615 820 504 0		1/4"	100	4.0	11.1	0.44	No	X				
615 820 505 0		1/4"	150	6.0	11.1	0.44	No	X				
615 820 405 0		1/4"	62	2.5	14.4	0.58	Yes				X	
615 820 403 0		1/4"	62	2.5	14.4	0.58	No				X	
615 820 254 0	T10	1/4"	49	2.0	-	-	Yes					X
615 820 255 0	T10	1/4"	70	2.8	-	-	Yes					X
615 820 698 0	T15	1/4"	49	2.0	-	-	Yes					X
615 820 256 0	T20	1/4"	49	2.0	-	-	Yes					X
615 820 244 0	T20	1/4"	75	3.0	-	-	Yes					X
615 820 252 0	T20	1/4"	150	6.0	-	-	Yes					X
615 820 700 0	T25	1/4"	49	2.0	-	-	Yes					X
615 820 701 0	T25	1/4"	70	2.8	-	-	Yes					X

Sockets and adaptors range

Ring magnet sleeves

PICTURE	d Max		D		L		PART NO
	mm	in	mm	in	mm	in	
A	3.1	0.12	9	0.35	16	0.63	615 811 423 0
	3.8	0.15	9	0.35	16	0.63	615 811 424 0
	4.5	0.18	9	0.35	16	0.63	615 811 425 0
	5	0.2	9	0.35	16	0.63	615 811 426 0
	6.1	0.26	11	0.43	16	0.63	615 811 427 0
	7.1	0.28	14	0.55	16	0.63	615 811 428 0
	8.2	0.32	14	0.55	16	0.63	615 811 429 0
	14	0.55	23.5	0.93	18	0.71	615 811 432 0
B	7	0.27	14	0.54	13	0.51	615 804 978 0

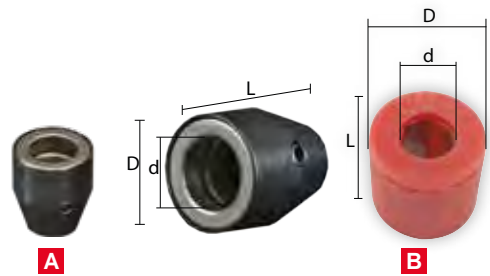

3/8" Hexagonal drives

A	B		L		L1		ØD		PART NO.
	mm	in	mm	in	mm	in	mm	in	
3/8"	4	0.16	60	1.97	16	0.63	19	0.75	909 201 378 1
3/8"	5	0.2	60	1.97	16	0.63	19	0.75	909 201 381 1
3/8"	8	0.31	60	1.97	16	0.63	19	0.75	909 201 387 1
3/8"	10	0.39	60	1.97	16	0.63	19	0.75	909 201 390 1

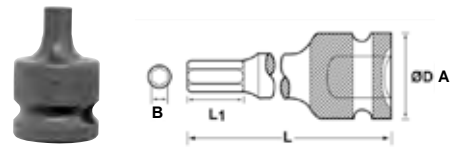

1/2" Hexagonal drives

A	B		L		L1		ØD		PART NO
	mm	in	mm	in	mm	in	mm	in	
1/2"	6	0.24	78	3.1	9	0.4	25	0.98	615 811 763 0
1/2"	8	0.31	78	3.1	16	0.6	25	0.98	909 201 396 1
1/2"	10	0.39	78	3.1	16	0.6	25	0.98	909 201 399 1
1/2"	14	0.55	78	3.1	20	0.8	25	0.98	909 201 405 1

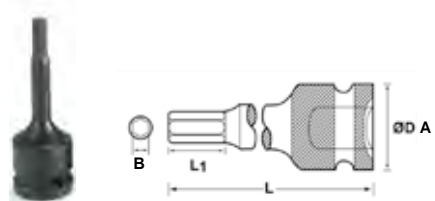

Internal Torx drives

A	B	L		L1		ØD		PART NO.
		mm	in	mm	in	mm	in	
3/8"	T25	40	2.95	3	0.12	22	0.87	615 811 434 0
3/8"	T30	40	2.95	3.8	0.15	22	0.87	615 811 435 0
3/8"	T40	40	2.95	3.8	0.15	22	0.87	615 811 436 0
1/2"	T40	55	2.95	3.8	0.15	25	0.98	615 811 437 0

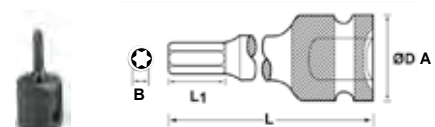

Sockets and adaptors range

1/4" = 6.35mm Square drive sockets

1/4" Standard

MODEL	OUTPUT SIZE		SHAPE	DIMENSIONS						PART NO.
	mm	in		D		D1		L		
				mm	in	mm	in	mm	in	
S2055M	5.5	0.22	A	13	0.51	9.4	0.37	23.1	0.91	894 016 367 5
S208M	8	0.31	A	13	0.51	12.2	0.48	23.1	0.91	894 016 367 8
S210M	10	0.39	B	13	0.51	14.7	0.58	23.1	0.91	894 016 368 0
S213M	13	0.51	B	13	0.51	18.8	0.74	23.1	0.91	894 016 368 3

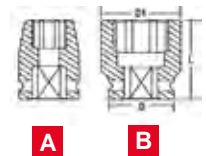

1/4" Deep

MODEL	OUTPUT SIZE		SHAPE	DIMENSIONS						PART NO.
	mm	in		D		D1		L		
				mm	in	mm	in	mm	in	
S210MD	10	2.5	B	13	0.51	14.7	0.58	50.0	1.97	894 016 370 4

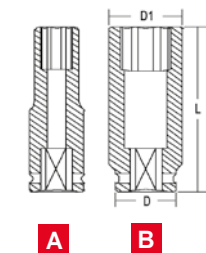

1/4" Magnetic

MODEL	OUTPUT SIZE		SHAPE	DIMENSIONS						PART NO.
	mm	in		D		D1		L		
				mm	in	mm	in	mm	in	
S208MG	8	2	A	13	0.51	12.2	0.48	23.1	0.91	894 016 374 3

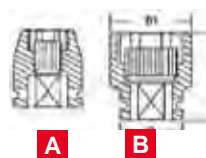

1/4" Deep Magnetic

MODEL	OUTPUT SIZE		SHAPE	DIMENSIONS						PART NO.
	mm	in		D		D1		L		
				mm	in	mm	in	mm	in	
S208MDG	8	0.31	A	13	0.51	12.2	0.48	50.0	1.97	894 016 376 5
S210MDG	10	0.39	B	13	0.51	14.5	0.57	50.0	1.97	894 016 376 7

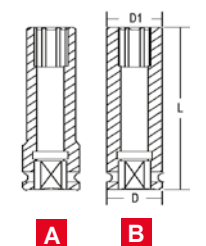

Sockets and adaptors range

3/8" = 9.52mm Square drive sockets

3/8" Standard

MODEL	OUTPUT SIZE		DESSIN	DIMENSIONS						PART NO.
	mm	in		D		D1		L		
S310M	10	0.39	A	19.0	0.75	15.2	0.6	29.5	1.16	894 016 378 8
S311M	11	0.43	A	19.0	0.75	17.0	0.67	29.5	1.16	894 016 378 9
S312M	12	0.47	B	19.0	0.75	19.0	0.75	29.5	1.16	894 016 379 0
S313M	13	0.51	B	19.0	0.75	19.0	0.75	29.5	1.16	894 016 379 1
S314M	14	0.55	B	20.0	0.79	20.0	0.79	29.5	1.16	894 016 379 2
S315M	15	0.59	B	22.1	0.87	22.1	0.87	29.5	1.16	894 016 379 3
S316M	16	0.63	B	23.6	0.93	23.6	0.93	30.0	1.18	894 016 379 4
S317M	17	0.67	B	23.9	0.94	23.9	0.94	30.0	1.18	894 016 379 5
S318M	18	0.71	B	24.9	0.98	24.9	0.98	30.0	1.18	894 016 379 6
S319M	19	0.75	B	25.9	1.02	25.9	1.02	30.0	1.18	894 016 379 7
S322M	22	0.87	B	30.0	1.18	30.0	1.18	30.0	1.18	894 016 380 0

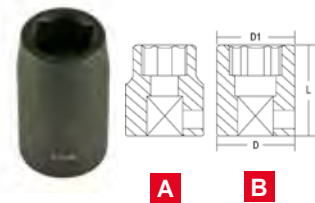

3/8" Deep

MODEL	OUTPUT SIZE		SHAPE	DIMENSIONS						PART NO.
	mm	in		D		D1		L		
S308MD	8	0.31	A	19.0	0.75	12.7	0.50	65.0	2.56	894 016 381 4
S310MD	10	0.39	A	19.0	0.75	15.2	0.60	65.0	2.56	894 016 381 6
S311MD	11	0.43	A	19.0	0.75	17.0	0.67	65.0	2.56	894 016 381 7
S313MD	13	0.51	B	19.0	0.75	19.0	0.75	65.0	2.56	894 016 381 9
S317MD	17	0.67	B	23.9	0.94	23.9	0.94	65.0	2.56	894 016 382 3

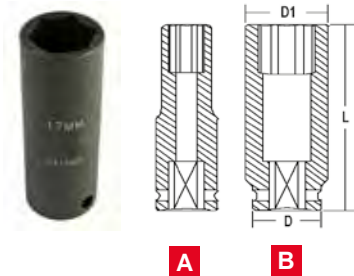

Sockets and adaptors range

3/8" Magnetic

MODEL	OUTPUT SIZE		SHAPE	DIMENSIONS						PART NO.
	mm	in		D		D1		L		
S310MG	10	0.39	A	19.0	0.75	15.2	0.6	29.5	1.16	894 016 389 5
S313MG	13	0.51	A	22.1	0.87	19.3	0.8	29.5	1.16	894 016 389 8
S314MG	14	0.55	A	22.1	0.87	20.3	0.8	29.5	1.16	894 016 389 9

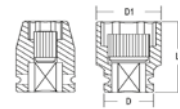

A B

3/8" Deep magnetic

MODEL	OUTPUT SIZE		SHAPE	DIMENSIONS						PART NO.
	mm	in		D		D1		L		
S313MDG	13	0.51	B	19.0	0.75	18.8	0.74	63	2.5	894 016 392 0

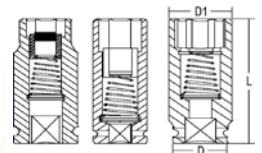

A B C

1/2" = 12.7mm Square drive sockets

1/2" Standard

MODEL	OUTPUT SIZE		SHAPE	DIMENSIONS						PART NO.
	mm	in		D		D1		L		
S408M	8	0.31	A	22.1	0.87	14.5	0.57	38.1	1.5	894 016 395 0
S409M	9	0.35	A	22.1	0.87	15.5	0.61	38.1	1.5	894 016 395 1
S410M	10	0.39	A	22.1	0.87	16.8	0.66	38.1	1.5	894 016 395 2
S412M	12	0.47	A	22.1	0.87	19.0	0.75	38.1	1.5	894 016 395 4
S413M	13	0.51	A	23.8	0.94	20.3	0.8	38.1	1.5	894 016 395 5
S415M	15	0.59	A	24.9	0.98	23.1	0.91	38.1	1.5	894 016 395 7
S417M	17	0.67	B	25.9	1.02	25.9	1.02	38.1	1.5	894 016 395 9
S418M	18	0.71	B	26.4	1.04	26.4	1.04	38.1	1.5	894 016 396 0
S419M	19	0.75	B	27.9	1.1	27.9	1.1	38.1	1.5	894 016 396 1
S420M	20	0.79	B	30.0	1.18	30.0	1.18	38.1	1.5	894 016 396 2
S421M	21	0.83	B	30.0	1.18	30.0	1.18	38.1	1.5	894 016 396 3
S422M	22	0.87	B	32.0	1.26	32.0	1.26	38.1	1.5	894 016 396 4
S424M	24	0.94	B	34.0	1.34	34.0	1.34	38.1	1.5	894 016 396 6
S426M	26	1.02	B	36.0	1.42	36.0	1.42	38.1	1.5	894 016 396 8
S427M	27	1.06	B	38.1	1.5	38.1	1.50	39.9	1.57	894 016 396 9
S428M	28	1.10	B	39.8	1.57	39.9	1.57	39.9	1.57	894 016 397 0
S429M	29	1.14	B	39.8	1.57	39.9	1.57	39.9	1.57	894 016 397 1
S430M	30	1.18	C	38.1	1.5	41.9	1.65	39.9	1.57	894 016 397 2
S431M	31	1.22	C	38.1	1.5	43.9	1.73	39.9	1.57	894 016 397 3
S432M	32	1.26	C	38.1	1.5	43.9	1.73	39.9	1.57	894 016 397 4



A B C

Sockets and adaptors range

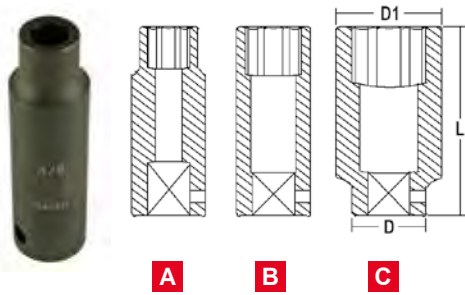

1/2" Deep

MODEL	OUTPUT SIZE		SHAPE	DIMENSIONS						PART NO.
	mm	in		D		D1		L		
S409MD	9	0.35	A	22.1	0.87	15.5	0.61	78.0	3.07	894 016 399 9
S411MD	11	0.43	A	22.1	0.87	18.0	0.71	78.0	3.07	894 016 400 1
S412MD	12	0.47	A	22.1	0.87	19.0	0.75	78.0	3.07	894 016 400 2
S413MD	13	0.51	A	23.9	0.94	20.3	0.8	78.0	3.07	894 016 400 3
S414MD	14	0.55	A	23.9	0.94	21.6	0.85	78.0	3.07	894 016 400 4
S415MD	15	0.59	B	23.9	0.94	23.9	0.94	78.0	3.07	894 016 400 5
S416MD	16	0.63	B	24.9	0.98	24.9	0.98	78.0	3.07	894 016 400 6
S417MD	17	0.67	B	25.9	1.02	25.9	1.02	78.0	3.07	894 016 400 7
S418MD	18	0.71	B	25.9	1.02	25.9	1.02	78.0	3.07	894 016 400 8
S419MD	19	0.75	B	27.9	1.1	27.9	1.1	78.0	3.07	894 016 400 9
S420MD	20	0.79	B	30.0	1.18	30.0	1.18	78.0	3.07	894 016 772 2
S421MD	21	0.83	B	30.0	1.18	30.0	1.18	78.0	3.07	894 016 401 0
S422MD	22	0.87	B	32.0	1.26	32.0	1.26	78.0	3.07	894 016 772 3
S423MD	23	0.91	B	32.0	1.26	32.0	1.26	78.0	3.07	894 016 772 4
S424MD	24	0.94	B	34.0	1.34	34.0	1.34	78.0	3.07	894 016 772 5
S425MD	25	0.98	B	36.1	1.42	36.1	1.42	78.0	3.07	894 016 772 6
S427MD	27	1.06	B	38.1	1.5	38.1	1.5	78.0	3.07	894 016 401 2
S430MD	30	1.18	C	38.1	1.5	41.9	1.65	78.0	3.07	894 016 401 5
S431MD	31	1.22	C	38.1	1.5	43.9	1.73	78.0	3.07	894 016 401 6
S432MD	32	1.26	C	38.1	1.5	43.9	1.73	78.0	3.07	894 016 401 7
S433MD	33	1.3	C	38.1	1.5	45.0	1.77	78.0	3.07	894 016 401 8
S434MD	34	1.34	C	38.1	1.5	46.0	1.81	78.0	3.07	894 016 401 9
S435MD	35	1.38	C	38.1	1.5	50.0	1.97	78.0	3.07	894 016 402 0
S436MD	36	1.42	C	38.1	1.5	50.0	1.97	78.0	3.07	894 016 402 1

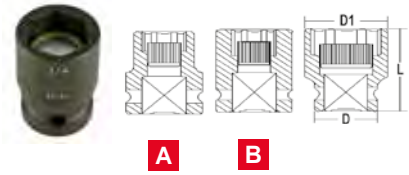

1/2" Magnetic

MODEL	OUTPUT SIZE		SHAPE	DIMENSIONS						PART NO.
	mm	in		D		D1		L		
S419MG	19	0.75	A	29.9	1.18	27.9	1.1	38.1	1.5	894 016 410 2
S421MG	21	0.83	B	29.9	1.18	29.9	1.18	38.1	1.5	894 016 410 4

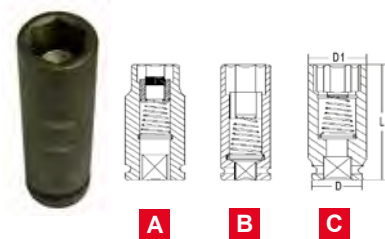

1/2" Deep Magnetic

MODEL	OUTPUT SIZE		SHAPE	DIMENSIONS						PART NO.
	mm	in		D		D1		L		
S414MDG	14	0.55	A	24.9	0.98	21.6	0.85	78	3.07	894 016 412 0

3/4" = 19mm Square Drive Sockets

3/4" Standard

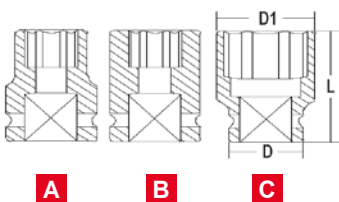

MODEL	OUTPUT SIZE		SHAPE	DIMENSIONS						PART NO.
	mm	in		D		D1		L		
S620M	20	0.79	A	38.1	1.5	31.0	1.22	52.1	2.05	894 016 418 1
S622M	22	0.87	A	38.1	1.5	34.0	1.34	52.1	2.05	894 016 418 3
S623M	23	0.91	A	38.1	1.5	35.0	1.38	52.1	2.05	894 016 418 4
S624M	24	0.94	A	38.1	1.5	36.0	1.42	52.1	2.05	894 016 418 5
S625M	25	0.98	B	38.1	1.5	38.1	1.5	52.1	2.05	894 016 418 6
S626M	26	1.02	B	39.8	1.57	39.9	1.57	52.1	2.05	894 016 418 7
S627M	27	1.06	B	39.8	1.57	39.9	1.57	52.1	2.05	894 016 418 8
S628M	28	1.1	B	41.9	1.65	41.9	1.65	52.1	2.05	894 016 418 9
S629M	29	1.14	B	41.9	1.65	41.9	1.65	52.1	2.05	894 016 419 0
S630M	30	1.18	B	43.9	1.73	43.9	1.73	52.1	2.05	894 016 419 1
S631M	31	1.22	B	43.9	1.73	43.9	1.73	55.9	2.2	894 016 419 2
S632M	32	1.26	B	43.9	1.73	43.9	1.73	55.9	2.2	894 016 419 3
S633M	33	1.3	C	43.9	1.73	47.0	1.85	55.9	2.2	894 016 419 4
S634M	34	1.34	C	43.9	1.73	48	1.89	55.9	2.2	894 016 419 5
S635M	35	1.38	C	43.9	1.73	50.0	1.97	55.9	2.2	894 016 419 6
S636M	36	1.42	C	43.9	1.73	51.0	2.01	55.9	2.2	894 016 419 7
S637M	37	1.46	C	43.9	1.73	52.1	2.05	55.9	2.2	894 016 419 8
S638M	38	1.5	C	43.9	1.73	53.1	2.09	55.9	2.2	894 016 419 9
S640M	40	1.57	C	43.9	1.73	55.9	2.2	62.0	2.44	894 016 420 0
S641M	41	1.61	C	43.9	1.73	57.9	2.28	62.0	2.44	894 016 420 1
S642M	42	1.65	C	43.9	1.73	61.0	2.4	62.0	2.44	894 016 420 2
S643M	43	1.69	C	43.9	1.73	63.0	2.48	63.0	2.48	894 016 420 3
S644M	44	1.73	C	43.9	1.73	65.0	2.56	63.0	2.48	894 016 420 4
S646M	46	1.81	C	43.9	1.73	67.0	2.64	63.0	2.48	894 016 420 5

Sockets and adaptors range

3/4" Deep

MODEL	OUTPUT SIZE		SHAPE	DIMENSIONS						PART NO.
	mm	in		D		D1		L		
	mm	in		mm	in	mm	in	mm	in	
S619MD	19	0.75	A	38.1	1.5	30.0	1.18	85.1	3.35	894 016 424 8
S621MD	21	0.83	A	38.1	1.5	32.0	1.26	85.1	3.35	894 016 425 0
S622MD	22	0.87	A	38.1	1.5	34.0	1.34	85.1	3.35	894 016 425 1
S623MD	23	0.91	A	38.1	1.5	35.0	1.38	85.1	3.35	894 016 425 2
S624MD	24	0.94	A	38.1	1.5	36.0	1.42	85.1	3.35	894 016 425 3
S625MD	25	0.98	B	38.1	1.5	38.1	1.5	85.1	3.35	894 016 425 4
S627MD	27	1.06	B	39.9	1.57	39.9	1.57	85.1	3.35	894 016 425 6
S630MD	30	1.18	B	43.9	1.73	43.9	1.73	85.1	3.35	894 016 425 9
S631MD	31	1.22	B	43.9	1.73	43.9	1.73	85.1	3.35	894 016 426 0
S632MD	32	1.26	B	43.9	1.73	43.9	1.73	85.1	3.35	894 016 426 1
S633MD	33	1.3	C	43.9	1.73	47.0	1.85	85.1	3.35	894 016 426 2
S634MD	34	1.34	C	43.9	1.73	48.0	1.89	85.1	3.35	894 016 426 3
S635MD	35	1.38	C	43.9	1.73	50.0	1.97	85.1	3.35	894 016 426 4
S636MD	36	1.42	C	43.9	1.73	51.0	2.01	85.1	3.35	894 016 426 5
S638MD	38	1.5	C	43.9	1.73	53.1	2.09	85.1	3.35	894 016 426 7
S640MD	40	1.57	C	43.9	1.73	55.9	2.2	85.1	3.35	894 016 426 8
S641MD	41	1.61	C	43.9	1.73	57.9	2.28	85.1	3.35	894 016 426 9
S642MD	42	1.65	C	43.9	1.73	60.1	2.4	85.1	3.35	894 016 427 0
S643MD	43	1.69	C	43.9	1.73	63.0	2.48	95.0	3.74	894 016 427 1
S644MD	44	1.73	C	43.9	1.73	65.0	2.56	95.0	3.74	894 016 427 2
S646MD	46	1.81	C	43.9	1.73	67.1	2.64	95.0	3.74	894 016 427 3

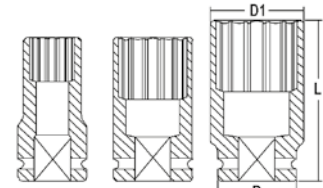

A

B

C

1" = 25.4mm Square Drive Sockets

1" Standard

MODEL	OUTPUT SIZE		SHAPE	DIMENSIONS						PART NO.
	mm	in		D		D1		L		
	mm	in		mm	in	mm	in	mm	in	
S819M	19	0.75	A	51.0	2.01	36.1	1.42	57.9	2.28	894 016 432 3
S821M	21	0.83	A	51.0	2.01	38.1	1.5	57.9	2.28	894 016 432 4
S822M	22	0.87	A	51.0	2.01	39.1	1.54	57.9	2.28	894 016 432 5
S823M	23	0.91	A	51.0	2.01	39.9	1.57	57.9	2.28	894 016 432 6
S824M	24	0.94	A	51.0	2.01	39.9	1.57	57.9	2.28	894 016 432 7
S825M	25	0.98	A	51.0	2.01	40.9	1.61	57.9	2.28	894 016 432 8
S827M	27	1.06	A	51.0	2.01	43.9	1.73	57.9	2.28	894 016 433 0
S828M	28	1.1	A	51.0	2.01	45.0	1.77	57.9	2.28	894 016 433 1
S829M	29	1.14	A	51.0	2.01	46.0	1.81	59.9	2.36	894 016 433 2
S830M	30	1.18	A	51.0	2.01	48.0	1.89	59.9	2.36	894 016 433 3
S832M	32	1.26	B	51.0	2.01	51.0	2.01	59.9	2.36	894 016 433 4
S833M	33	1.3	C	52.1	2.05	53.1	2.09	62.0	2.44	894 016 433 5
S835M	35	1.38	C	52.1	2.05	54.1	2.13	62.0	2.44	894 016 433 6
S836M	36	1.42	C	52.1	2.05	55.9	2.2	62.0	2.44	894 016 433 7
S838M	38	1.5	C	52.1	2.05	57.9	2.28	62.0	2.44	894 016 433 8
S840M	40	1.57	C	52.1	2.05	59.9	2.36	62.0	2.44	894 016 433 9
S841M	41	1.61	C	52.1	2.05	61.5	2.42	62.0	2.44	894 016 434 0
S843M	43	1.69	C	52.0	2.05	64.8	2.55	64.0	2.52	894 016 434 2
S844M	44	1.73	C	57.9	2.28	65.8	2.59	64.0	2.52	894 016 434 3
S846M	46	1.81	C	57.9	2.28	68.1	2.68	64.0	2.52	894 016 434 5

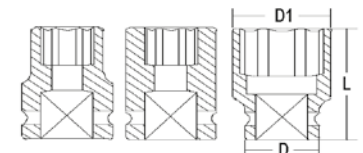

A

B

C

Sockets and adaptors range

1" Standard

MODEL	OUTPUT SIZE		SHAPE	DIMENSIONS						PART NO.
	mm	in		D		D1		L		
S852M	52	2.05	C	57.9	2.28	74.9	2.95	70.1	2.76	894 016 434 7
S854M	54	2.13	C	57.9	2.28	78.0	3.07	70.1	2.76	894 016 434 8
S855M	55	2.17	C	62.0	2.44	79.0	3.11	71.9	2.83	894 016 434 9
S856M	56	2.2	C	61.2	2.44	80.0	3.15	73.9	2.91	894 016 435 0
S858M	58	2.28	C	61.0	2.44	85.1	3.35	74.9	2.95	894 016 435 1
S860M	60	2.36	C	61.0	2.44	87.1	3.43	78.0	3.07	894 016 435 2
S865M	65	2.56	C	61.0	2.44	93.0	3.66	80.0	3.15	894 016 435 3
S870M	70	2.76	C	62.0	2.44	98.0	3.86	85.1	3.35	894 016 435 4

1" Deep

MODEL	OUTPUT SIZE		SHAPE	DIMENSIONS						PART NO.
	mm	in		D		D1		L		
S821MD	21	0.83	A	51.0	2.01	38.1	1.5	89.9	3.54	894 016 440 4
S824MD	24	0.94	A	51.0	2.01	39.9	1.57	89.9	3.54	894 016 440 7
S827MD	27	1.06	A	51.0	2.01	43.9	1.73	89.9	3.54	894 016 441 0
S829MD	29	1.14	A	51.0	2.01	46.0	1.81	89.9	3.54	894 016 441 2
S830MD	30	1.18	A	51.0	2.01	48.0	1.89	89.9	3.54	894 016 441 3
S832MD	32	1.26	B	51.0	2.01	51.0	2.01	89.9	3.54	894 016 441 4
S833MD	33	1.3	C	52.1	2.05	53.1	2.09	89.9	3.54	894 016 441 5
S834MD	34	1.34	C	52.1	2.05	54.1	2.13	89.9	3.54	894 016 441 6
S835MD	35	1.38	C	52.1	2.05	54.1	2.13	89.9	3.54	894 016 441 7
S836MD	36	1.42	C	52.1	2.05	55.9	2.2	89.9	3.54	894 016 441 8
S838MD	38	1.5	C	52.1	2.05	57.9	2.28	91.9	3.62	894 016 441 9
S841MD	41	1.61	C	52.1	2.05	61.5	2.42	91.9	3.62	894 016 442 1
S842MD	42	1.65	C	52.1	2.05	63.0	2.48	91.9	3.62	894 016 442 2
S843MD	43	1.69	C	52.1	2.05	65.0	2.56	91.9	3.62	894 016 442 3
S844MD	44	1.73	C	57.9	2.28	66.0	2.6	91.9	3.62	894 016 442 4
S845MD	45	1.77	C	57.9	2.28	67.0	2.64	91.9	3.62	894 016 442 5
S846MD	46	1.81	C	57.9	2.28	68.0	2.68	91.9	3.62	894 016 442 6
S850MD	50	1.97	C	57.9	2.28	72.9	2.87	95.0	3.74	894 016 442 7
S852MD	52	2.05	C	57.9	2.28	74.9	2.95	95.0	3.74	894 016 442 8
S854MD	54	2.13	C	57.9	2.28	78.0	3.07	95.0	3.74	894 016 442 9
S855MD	55	2.17	C	62.0	2.44	79.0	3.11	100.1	3.94	894 016 443 0
S856MD	56	2.2	C	62.0	2.44	80.0	3.15	100.1	3.94	894 016 443 1
S858MD	58	2.28	C	62.0	2.44	85.1	3.35	104.9	4.13	894 016 443 2
S860MD	60	2.36	C	62.0	2.44	87.1	3.43	104.9	4.13	894 016 443 3
S865MD	65	2.56	C	62.0	2.44	93.0	3.66	119.9	4.72	894 016 443 4
S831D*	1-15/16"		C	57.9	2.28	71.9	2.83	91.9	3.62	894 016 437 4
S832D*	2"		C	57.9	2.28	73.9	2.91	95.0	3.74	894 016 437 5
S833D*	2-1/16"		C	57.9	2.28	74.9	2.95	95.0	3.74	894 016 437 6
S835D*	2-3/16"		C	62.0	2.44	80.0	3.15	100.1	3.94	894 016 437 8
S836D*	2-1/4"		C	62.0	2.44	84.1	3.31	100.1	3.94	894 016 437 9
S837D*	2-5/16"		C	62.0	2.44	86.1	3.39	104.9	4.13	894 016 438 0
S839D*	2-7/16"		C	62.0	2.44	88.9	3.5	110.0	4.33	894 016 438 2
S840D*	2-1/2"		C	62.0	2.44	90.9	3.58	110.0	4.33	894 016 438 3
S841D*	2-9/16"		C	62.0	2.44	93.0	3.66	119.9	4.72	894 016 438 4
S843D*	2-11/16"		C	62.0	2.44	97.0	3.82	123.9	4.88	894 016 438 6

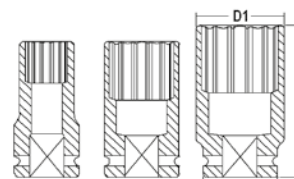

A

B

C



Sockets and adaptors range

O-Ring & Retaining Pins

A		ØB		PART NO.
mm	in	mm	in	O-Ring
19.05	3/4	31.7	1 1/4	C-155467
19.05	3/4	36.5	1 4/9	C-155468
19.05	3/4	41.3	1 5/8	C-134690
19.05	3/4	44.4	1 3/4	C-134691
25.4	1	44.4	1 3/4	C-155470
25.4	1	50.8	2	C-155471
25.4	1	54.0	2 1/8	C-155472
25.4	1	57.1	2 1/4	C-134692
38.1	1 1/2	73.0	2 7/8	C-134693
38.1	1 1/2	85.7	3 3/8	C-134694
38.1	1 1/2	98.4	3 7/8	C-134695
38.1	1 1/2	111.1	4 3/8	C-134696



Bit Adaptors

A	B	L		Ø MAX		RETENTION	PART NO.
		mm	in	mm	in		
3/8"	Hex 1/4" (D6.3)*	32	1.26	16	0.63	Ball retention	21792
3/8"	Hex 1/4" (F6.3)**	46	1.81	22	0.87	Q/R	108052
1/2"	Hex 1/4" (D6.3)*	45	1.77	22	0.87	Q/R	615 812 306 0

*Insert **Direct

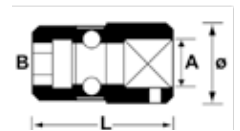

Stud Runners

A	B	L		Ø		D		PART NO.
		mm	in	mm	in	mm	in	
3/8"	M5 x 80	50	2	15	0.59	19	0.75	615 811 727 0
3/8"	M6 x 100	50	2	15	0.59	19	0.75	615 811 728 0
3/8"	M8 x 125	50	2	17	0.67	19	0.75	615 811 729 0
3/8"	M10 x 150	50	2	19	0.75	24	0.94	615 811 730 0
1/2"	M6 x 100	55	2.2	22	0.87	24	0.94	615 811 731 0
1/2"	M8 x 125	55	2.2	24	0.94	24	0.94	615 811 732 0
1/2"	M10 x 125	55	2.2	24	0.94	24	0.94	615 811 733 0
1/2"	M10 x 150	55	2.2	24	0.94	24	0.94	615 811 734 0
1/2"	M12 x 175	55	2.2	24	0.94	24	0.94	615 811 735 0
1/2"	M14 x 150	55	2.2	24	0.94	24	0.94	615 811 736 0
1/2"	M14 x 200	55	2.2	24	0.94	24	0.94	615 811 737 0
1/2"	M16 x 200	55	2.2	24	0.94	24	0.94	615 811 738 0

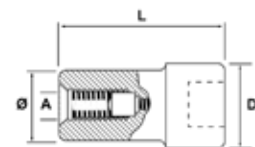

Sockets and adaptors range

Bit Adaptors - Positive Retention

A	B	L		Ø MAX		L1		PART NO.
		mm	in	mm	in	mm	in	
3/8"	Hex 1/4"	14	0.55	14	0.55	38	1.5	615 812 206 0

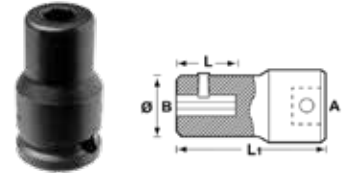

Extension Bars

A	B	L		ØD		PART NO.
		mm	in	mm	in	
3/8"	3/8"	45	1.77	19	0.75	894 016 598 5
3/8"	3/8"	75	2.95	19	0.75	894 016 598 6
3/8"	3/8"	150	5.91	19	0.75	894 016 598 7
1/2"	1/2"	75	2.95	30	1.18	894 016 599 4
1/2"	1/2"	127	5	30	1.18	894 016 599 5
1/2"	1/2"	178	7.01	30	1.18	894 016 599 6
1/2"	1/2"	254	10	30	1.18	894 016 599 7
3/4"	3/4"	75	2.95	44	1.73	894 016 600 4
3/4"	3/4"	175	6.89	44	1.73	894 016 600 5
3/4"	3/4"	254	10	44	1.73	894 016 600 6
3/4"	3/4"	330	12.99	44	1.73	894 016 600 7
1"	1"	178	7.01	54	2.13	894 016 601 2
1"	1"	254	10	54	2.13	894 016 601 3
1"	1"	330	12.99	54	2.13	894 016 601 4

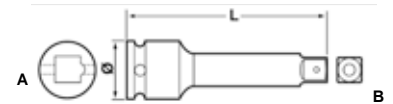

Adaptors

A	B	L		Ø		PART NO.
		mm	in	mm	in	
1/4"	3/8"	13	0.51	26	1.02	894 016 597 8
3/8"	1/4"	22	0.87	32	1.26	894 016 598 3
3/8"	1/2"	22	0.87	32	1.26	894 016 598 4
1/2"	3/8"	25	0.98	38	1.5	894 016 599 2
1/2"	3/4"	30	1.18	48	1.89	894 016 599 3
3/4"	1/2"	44	1.73	56	2.2	894 016 600 1
3/4"	1"	44	1.73	63	2.48	894 016 600 2
1"	3/4"	54	2.13	75	2.95	894 016 600 9



Universal Joints

A	B	L		Ø		PART NO.
		mm	in	mm	in	
1/4"	1/4"	44	1.73	20	0.79	894 016 598 2
1/2"	1/2"	63	2.48	34	1.34	894 016 599 8
3/4"	3/4"	90	3.54	49.2	1.94	894 016 600 8
1"	1"	114	4.49	59.2	2.33	894 016 601 5



Quick Change Adapters

A	B	L		ØD		PART NO.
		mm	in	mm	in	
3/8"	3/8"	46	1.81	19	0.75	615 811 589 0
1/2"	1/2"	60	2.36	25	0.98	615 811 590 0
3/4"	3/4"	78	3.07	44	1.73	615 811 591 0
3/8"	1/2"	60	2.36	20	0.79	615 811 592 0
1/2"	3/8"	54	2.13	25	0.98	615 811 593 0
3/4"	1/2"	70	2.76	44	1.73	615 811 595 0



Sleeve drive socket - Pulse tools*

For Desoutter PTF models and all Japanese pulse tools

Drive 3/8"

OUTPUT SIZE		DIMENSIONS								PART NO.
mm	in	D2		D1		L2		L		
mm	in	mm	in	mm	in	mm	in	mm	in	
8	0.31	19	0.75	13	0.51	7	0.28	43	1.69	615 811 777 0
10	0.39	19	0.75	16	0.63	7	0.28	43	1.69	615 811 778 0
11	0.43	19	0.75	17.5	0.69	8	0.31	43	1.69	615 811 779 0
12	0.47	19	0.75	18.5	0.73	9	0.35	43	1.69	615 811 780 0
13	0.51	22	0.87	20	0.79	9	0.35	43	1.69	615 811 781 0
14	0.55	22	0.87	21	0.83	9	0.35	43	1.69	615 811 782 0
17	0.67	22	0.87	25	0.98	12	0.47	43	1.69	615 811 783 0
18	0.71	22	0.87	26	1.02	12	0.47	43	1.69	615 811 784 0
19	0.75	22	0.87	27	1.06	12	0.47	43	1.69	615 811 785 0

*Not suitable for Desoutter PT models

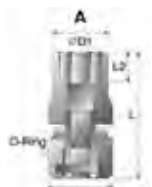

Drive 1/2"

OUTPUT SIZE		DIMENSIONS								PART NO.
A		D2		D1		L2		L		
mm	in	mm	in	mm	in	mm	in	mm	in	
12	0.47	25	0.98	20	0.79	12	0.47	52	2.05	615 811 788 0
13	0.51	25	0.98	21	0.83	12	0.47	52	2.05	615 811 789 0
14	0.55	25	0.98	22.5	0.89	12	0.47	52	2.05	615 811 790 0
15	0.59	30	1.18	23.5	0.93	12	0.47	52	2.05	615 811 791 0
16	0.63	30	1.18	25	0.98	12	0.47	52	2.05	615 811 792 0
17	0.67	30	1.18	26	1.02	13	0.51	52	2.05	615 811 793 0
18	0.71	30	1.18	27.5	1.08	13	0.51	52	2.05	615 811 794 0
19	0.75	30	1.18	28.5	1.12	13	0.51	52	2.05	615 811 795 0
21	0.83	30	1.18	31	1.22	14	0.55	52	2.05	615 811 797 0
22	0.87	30	1.18	32	1.26	14	0.55	52	2.05	615 811 798 0
23	0.91	30	1.18	34	1.34	14	0.55	52	2.05	615 811 799 0
24	0.94	30	1.18	35	1.38	15	0.59	52	2.05	615 811 800 0
25	0.98	30	1.18	36	1.42	15	0.59	57	2.24	615 811 801 0
27	1.06	30	1.18	38.5	1.52	17	0.67	57	2.24	615 811 803 0
30	1.18	30	1.18	42	1.65	18	0.71	57	2.24	615 811 806 0
32	1.26	30	1.18	44	1.73	20	0.79	62	2.44	615 811 807 0

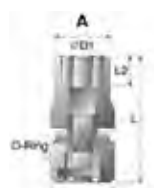

3/8" Hexagonal Drives

OUTPUT SIZE		DIMENSIONS						PART NO.
A		D2		L1		L		
mm	in	mm	in	mm	in	mm	in	
4	0.16	22	0.87	11	0.43	75	2.95	615 811 824 0
5	0.20	22	0.87	11	0.43	75	2.95	615 811 825 0
6	0.24	22	0.87	11	0.43	75	2.95	615 811 826 0
8	0.31	22	0.87	16	0.63	75	2.95	615 811 827 0
10	0.39	22	0.87	16	0.63	75	2.95	615 811 828 0



1/2" Hexagonal Drives

OUTPUT SIZE		DIMENSIONS						PART NO.
A		D2		L1		L		
mm	in	mm	in	mm	in	mm	in	
6	0.24	25	0.98	15	0.59	75	2.95	615 811 829 0
8	0.31	25	0.98	25	0.98	75	2.95	615 811 830 0
10	0.39	25	0.98	25	0.98	75	2.95	615 811 831 0
17	0.67	25	0.98	25	0.98	75	2.95	615 811 833 0
19	0.75	25	0.98	25	0.98	75	2.95	615 811 834 0



Sleeve drive socket - Pulse tools*

For Desoutter PTF models and all Japanese pulse tools

Internal Torx

DRIVE A	OUTPUT SIZE TORX B	DIMENSIONS						PART NO.
		D2		L1		L		
		mm	in	mm	in	mm	in	
3/8"	T20	22	0.87	2.8	0.11	75	2.95	615 811 841 0
3/8"	T25	22	0.87	3	0.12	75	2.95	615 811 842 0
3/8"	T30	22	0.87	3.8	0.15	75	2.95	615 811 843 0
3/8"	T40	22	0.87	3.8	0.15	75	2.95	615 811 844 0
1/2"	T40	25	0.98	3.8	0.15	75	2.95	615 811 845 0



External Torx

DRIVE A	OUTPUT B	DIMENSIONS								PART NO.
		D2		D1		L2		L		
		mm	in	mm	in	mm	in	mm	in	
3/8"	E8	19	0.75	11	0.43	6.5	0.26	43	1.69	615 811 846 0
3/8"	E10	19	0.75	13	0.51	7.5	0.30	43	1.69	615 811 847 0
3/8"	E12	19	0.75	15.5	0.61	8.5	0.33	43	1.69	615 811 848 0
3/8"	E14	22	0.87	17.5	0.69	10	0.39	43	1.69	615 811 849 0
1/2"	E10	25	0.98	14	0.55	7.5	0.30	52	2.05	615 811 850 0
1/2"	E12	25	0.98	16	0.63	8.5	0.33	52	2.05	615 811 851 0
1/2"	E14	25	0.98	18	0.71	10	0.39	52	2.05	615 811 852 0
1/2"	E16	25	0.98	20	0.79	11	0.43	52	2.05	615 811 853 0
1/2"	E18	25	0.98	22	0.87	12.5	0.49	52	2.05	615 811 854 0



Extension Bars

DRIVE A	OUTPUT B	DIMENSIONS				PART NO.
		D2		L		
		mm	in	mm	in	
3/8"	3/8	22	0.87	75	2.95	615 811 859 0
3/8"	3/8	22	0.87	125	4.92	615 811 861 0
3/8"	3/8	22	0.87	250	9.84	615 811 864 0
1/2"	1/2	-	-	75	2.95	615 811 865 0
1/2"	1/2	-	-	125	4.92	615 811 867 0
1/2"	1/2	-	-	175	6.89	615 811 869 0
1/2"	1/2	25	0.98	250	9.84	615 811 871 0

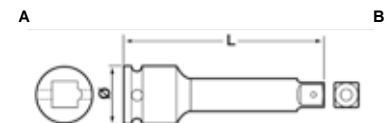

Sleeve drive socket - Pulse tools*

For Desoutter PTF models and all Japanese pulse tools

Stud setter sockets

DRIVE A	OUTPUT B	D2		D1		L		PART NO.
		mm	in	mm	in	mm	in	
3/8"	M6 x P1	22	0.87	12.5	0.49	50	1.97	615 811 876 0
3/8"	M8 x P1.25	22	0.87	14.5	0.57	50	1.97	615 811 877 0
3/8"	M10 x P1.5	22	0.87	17	0.67	50	1.97	615 811 878 0
1/2"	M6 x P1	25	0.98	13	0.51	75	2.95	615 811 879 0
1/2"	M8 x P1.25	25	0.98	15	0.59	75	2.95	615 811 880 0
1/2"	M10 x P1.5	25	0.98	17	0.67	75	2.95	615 811 881 0
1/2"	M12 x P1.75	25	0.98	19	0.75	75	2.95	615 811 882 0
1/2"	M14 X P2	25	0.98	22	0.87	75	2.95	615 811 883 0
1/2"	M16 x P2	30	1.18	27	1.06	75	2.95	615 811 884 0



Bit adaptors

DRIVE A	OUTPUT B	D2		L		PART NO.
		mm	in	mm	in	
3/8"	1/4	22	0.87	52	2.05	615 811 885 0
1/2"	1/4	25	0.98	60	2.36	615 811 887 0



*Not suitable for Desoutter PT models

Safety Instructions

General Safety Instructions for the Operation of Power Tools

The goal of Desoutter is to produce tools that help the operator work safely and efficiently.

The most important safety device for this or any other tool is the operator. Care and good judgement are the best protection against injury.

All possible hazards cannot be covered here, but we have tried to highlight some of the important ones.

Individuals should look for and obey Caution, Warning and Danger signs placed on tools and displayed in the workplace. Operators should read and follow safety instructions packed with each tool. For a copy of these instructions, contact your local Desoutter representative.

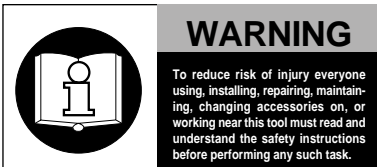

Learn how each tool works. Even if you have previously used similar tools, carefully check out each tool before you use it. Get the 'feel' of it and know its capabilities, limitations, potential hazards, how it operates and how it stops.

All tools are designed to operate at a line pressure of 6.3 bar +/- 0.15bar in accordance with ISO2787, 8NTC1.2.

Sound levels +/- 3dB(A)* are measured in accordance with EN ISO15744. Vibration values* are measured in accordance with ISO8662 & ISO28927.

*These declared values were obtained by laboratory type testing in accordance with the stated standards and are suitable for comparison with the declared values of other tools tested in accordance with the same standards. These declared values are not adequate for use in risk assessments and values measured in individual work places may be higher. The actual exposure values and risk of harm experienced by an individual user are unique and depend upon the way the user works, the workpiece and the workstation design, as well upon the exposure time and the physical condition of the user.

We, Desoutter, cannot be held liable for the consequences of using the declared values, instead of values reflecting the actual exposure, in an individual risk assessment in a work place situation over which we have no control.

Tools are CE marked to comply with European Machinery Directive.

Specifications subject to change without prior notice.

Further occupational health and safety information can be obtained from the following web sites:

<http://www.osha.gov> (USA) <http://europe.osha.eu.int> (Europe).



COMPRESSED AIR HAZARDS

- Air under pressure can cause injury. Never point an air hose at yourself or anyone else. Never blow your clothes free of dust with compressed air. Always direct exhaust air away from yourself and others in the work area.
- Always check for damaged or loose hoses and fittings before using an air tool, and replace if necessary. Whipping hoses can cause serious injury.
- Disconnect the tool from the air supply when not in use, before changing accessories, setting the torque, or when making repairs.
- Do not exceed rated air pressure to increase the output of the tool. This could cause injury and shorten tool life.
- Do not assemble quick coupler on the tool. Vibration can cause breakage resulting in a whipping air hose. Instead, use quick couplers on the end of a short leader hose.
- When universal twist couplings are used, lock pins must be installed to prevent accidental hose disconnection.
- Air tools are not intended for use in explosive atmospheres and are not insulated for contact with electric power sources.



ELECTRICAL HAZARDS

- Power tool plugs must match the outlet. Never modify the plug in any way. Do not use any adaptor plugs with earthed (grounded) power tools and equipment. Unmodified plugs and matching outlets will reduce risk of electric shock.
- Avoid body contact with earthed or grounded metal surfaces. There is an increased risk of electric shock if your body is earthed or grounded.
- Do not abuse the cord. Never use the cord for carrying, pulling or unplugging the power tool. Keep cord away from heat, oil, sharp edges or moving parts. Damaged or entangled cords increase the risk of electric shock.
- Do not expose electric power tools and equipment to wet conditions.
- Do not operate power tools in explosive atmospheres. Power tools create sparks which may ignite dust, fumes or flammable liquids.
- Have electric power tools and equipment serviced by a qualified repair person using only identical replacement parts.



PROJECTILE HAZARDS

- Always wear impact resistant eye and face protection when involved with or near the operation or repair of tools.



BREATHING HAZARDS

- Proper breathing protection must be worn when working with materials, which produce airborne particles.



NOISE HAZARDS

- Hearing loss can result from prolonged exposure to excessive sound levels.
- Use hearing protection as recommended by your employer or Occupational Health and Safety Regulations.



VIBRATION HAZARDS

- Repetitive work motions, awkward positions, and exposure to vibration may be harmful to your hands and arms.
- If numbness, tingling, pain or whitening of the skin occurs, stop using tool and consult a physician.



ENTANGLEMENT HAZARDS

- To reduce the risk of injury from entanglement, do not wear loose clothing when using rotating accessories.



ADDITIONAL HAZARDS

- Slip/Trip/Fall is a major cause of serious injury or death. Beware of excessive hose/cord left on the walking or work surface.
- Operators and maintenance personnel must be physically fit to perform job tasks, and handle the bulk, weight and power of the tool.
- Deburring tools should be used to reduce the risk of cuts and abrasions due to burrs.
- Wear gloves to protect hands from sharp edges.

Safety Instructions

Specific Safety Instructions for Power Tool Groups

In addition to the General Safety Instructions, the following are safety instructions and warnings that apply to the safe operation of specific power tool groups.



COMPRESSION TOOLS

- To reduce the risk of injury always keep hands and fingers away from yoke and moving jaws, sets or dies. If possible, hold the tool body with both hands.
- Inspect the yoke daily for cracks. Injury may result if a cracked yoke fails during use.
- All yokes have a life limitation based on cycles and riveting force. This tool and its accessories must not be modified.



DRILLS & TAPPERS

- Keep away from rotating bit and chuck. You can become cut or burned if you come into contact with the drill bit or tap, chips/swarf, or work surface.
- Use intermittent drill feed pressure to avoid long shaved chips/swarf.
- The drill bit or tap can suddenly bind and cause the workpiece or tool to rotate, causing arm and shoulder injuries.
- It is recommended that side handles are used for operator comfort and safety on high torque drilling applications above 4Nm (3 lbft) on straight case tools and 10Nm (7.4 lbft) on pistol grip drills. Drills with a chuck capacity larger than 10mm (3/8») should always be used with a side handle.



PERCUSSIVE TOOLS

(Riveting Hammers, Air Scribe)

- All chisels, rivet sets and other associated accessories should be checked for cracks, excessive wear, or other physical damage before each use. Accessories that show signs of damage should be replaced immediately.
- Never use a tool without the proper accessory retainer.



PULSE TOOLS

- Never use hand sockets or accessories. Use only impact sockets and accessories in good condition. Sockets in poor condition reduce impact power and could also shatter, resulting in personal injury.
- When using a universal joint, never operate the tool off the work. It may run too fast and cause the joint to be thrown from the tool.
- Always use the simplest hook up possible. Long springy extension bars and adaptors absorb impact power and could break loose resulting in personal injury. Instead, use deep sockets wherever possible.
- For tools using the pin and o-ring socket retainer, use the o-ring to securely retain the socket pin or use a one-piece retainer ring to retain the socket.
- Serious injury can result from overtorqued or under-torqued fasteners, which can break, or loosen and separate. Released assemblies can become projectiles. Assemblies requiring a specific torque must be checked using a torque meter.

NOTE: So-called 'click' torque wrenches do not check for potentially dangerous over-torqued conditions.



ANGLE WRENCHES

- Never use hand sockets or accessories. Use only power drive sockets and accessories.
- To reduce the risk of injury, always support the handle securely in the direction opposite of the spindle rotation to minimize torque reaction.



ACCESSORIES

- Always use accessories of correct size and design for the tool. Tool and accessories must not be modified in any way.
- Never use a tool without the proper accessory retainer.
- Do not use a tool or attachment for a purpose not intended by the manufacturer.



OTHER TOOLS

(e.g. Screwdrivers, Shears, Saws, etc.)

- Specific instructions/warnings affecting this group of tools are contained in product-specific documents accompanying each product.



ABRASIVE TOOLS

- Before grinding, test grinding wheel by briefly running tool at full throttle. Be sure to use a barrier (such as under a heavy work table) to protect yourself from possible broken wheel parts.
- Never mount a grinding wheel on a sander.
- Never use a grinding wheel rated at a speed lower than the air grinder speed.
- All grinding wheels and polishing/sanding accessories should be checked for cracks or other damage before mounting and use.
- Always use the recommended wheel guard to prevent injury when performing grinding operations. If a guard has withstood wheel or disk breakage, it must be replaced.
- Position a guard between the grinding wheel or disc and the operator.
- Use barriers to protect others from fragments and grinding sparks.
- Make sure grinding wheels are mounted according to manufacturer's specifications: always use correct mounting flanges.
- Never tamper with or remove a speed governor from a tool to make it run faster. Periodically check tool speed with a tachometer.

For complete safety instructions, please see the documentation provided with each tool.

All products in this catalog are subject to Californian Proposition 65.



Warning

Cancer and reproductive harm - <http://www.P65warnings.ca.gov>.

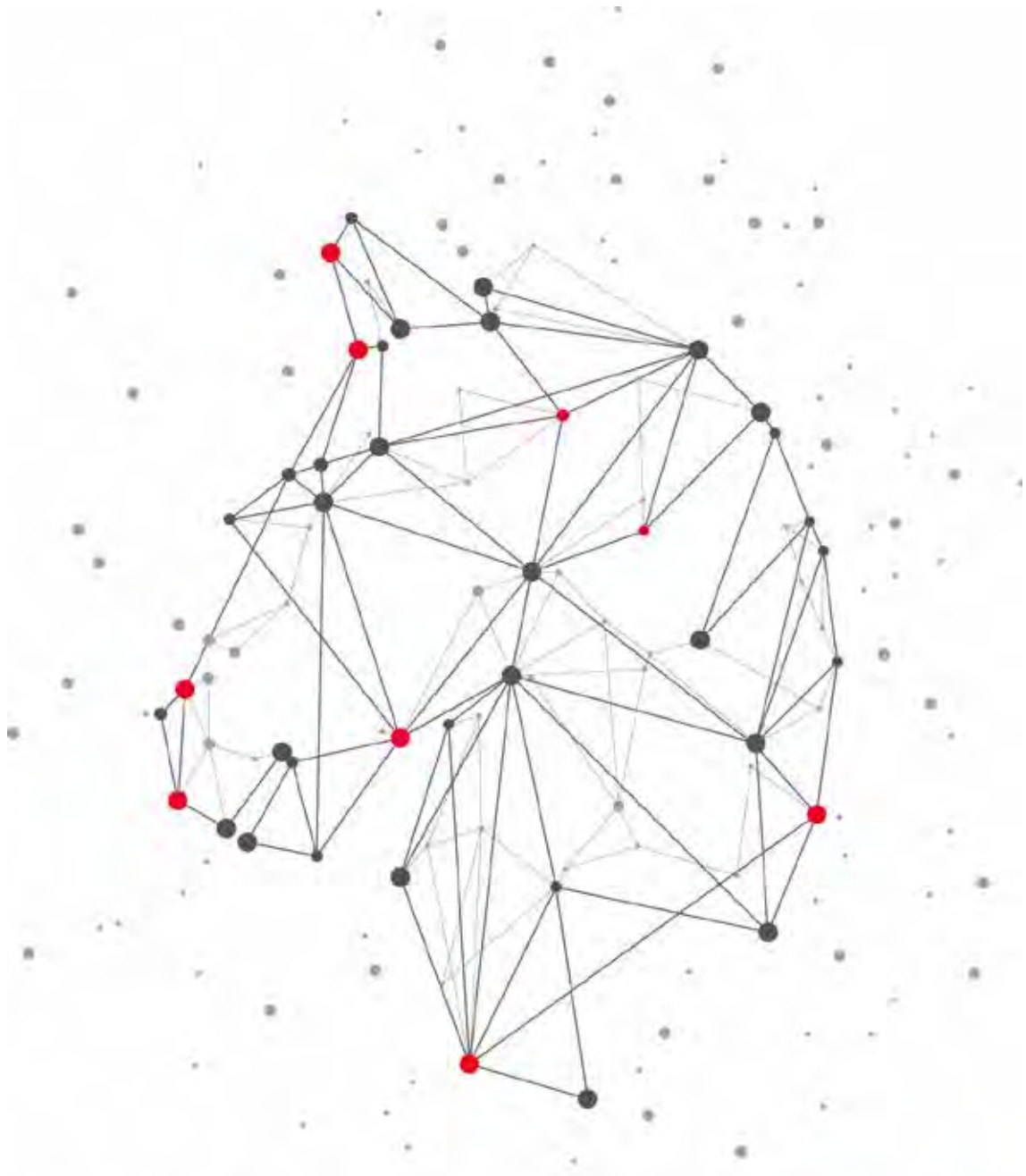

DESOUTTER 4.0

More Than Productivity

Applifast.



251 Cree Crescent, Winnipeg, MB Canada R3J 3X4
Tel: 204 837 8361 • 1 800 563 1293
info@applifast.com



applifast.com