



Compact Catalogue



CONTENT

Screwdrivers



Kraftform Stainless Steel	6
Kraftform Plus - Series 900	8
Kraftform Plus - Series 300	12
Flagdriver Series	30
Screwdriving Accessories	31
Kraftform Micro	34
400 T-Handle Series	41
ESD Tools	49

Tools for Electricians



Kraftform Stainless VDE	59
Kraftform 100 VDE	60
Kraftform Kompakt VDE Stainless	70
Kraftform Kompakt VDE	74
Kraftform Kompakt Turbo i	79
Kraftform 1000 VDE	85
Series T-handle Screwdrivers	86
The Zyklop Ratchet VDE and Accessories	86
Joker VDE Self-setting, Adjustable Spanner	90
Torque-indicators for Electricians	91

Ratchets & Accessories



1/4" Zyklop Speed	94
1/4" Zyklop Metal Push	99
1/4" Zyklop Metal Switch	100
1/4" Zyklop Accessories	102
3/8" Zyklop Speed	112
3/8" Zyklop Metal Push	116
3/8" Zyklop Metal Switch	118
3/8" Zyklop Accessories	120
1/2" Zyklop Speed	132
1/2" Zyklop Hybrid	135
1/2" Zyklop Metal Push	136
1/2" Zyklop Metal Switch	137
1/2" Zyklop Accessories	138
Zyklop Pocket	152
1/2" Koloss	154
Zyklop Mini	157
Tool-Check	159

Joker Wrenches & Spanners



6000 Joker Ratcheting Combination Wrenches	168
6001 Joker Switch Ratcheting Combination Wrenches, with Switch Lever	170
6002 Joker Double Open-Ended Wrenches	171
6003 Joker Ring Spanner	173
6004 Joker Self-setting, Adjustable Spanner	178
6005 Joker Double Open-Ended Wrenches	179

L-Keys



L-Keys for Hexagon Socket Screws	182
L-Keys for TORX® Screws	195

Kraftform Kompakt



Kraftform Kompakt Turbo	202
Kraftform Kompakt 10, 12	203
Kraftform Kompakt 20, 22, 25, 26, 27, 28	204
Kraftform Kompakt 40, 41	208
Kraftform Kompakt 60, 62	209
Kraftform Kompakt 70, 71	213
Kraftform Kompakt 100	214
Kraftform Kompakt 400	215
Kraftform Kompakt 400 RA	215
Kraftform Kompakt 900	217
Kraftform Kompakt Stubby	220
Kraftform Kompakt User-Specific Sets	224
Bitholding Screwdrivers and Adaptors	230
Kraftform Kompakt with Ratchet Function	233
Kraftform Kompakt Vario without Ratchet Function	235

Roller cabinet and foam inserts



Roller cabinet	240
Foam inserts for roller cabinet	241

Wera 2go



Wera 2go 1 Tool Carrier	252
Wera 2go 2 Tool Container	252
Wera 2go 3 Tool Box	253
Wera 2go 4 Tool Quiver	254
Wera 2go 5 Tool Carrier	254
Wera 2go 6 Shoulder Strap	254
Wera 2go 7 High Tool Box	254
Wera 2go H 1 Tool Set for Wood Applications	255
Wera 2go E 1 Tool set for electricians	256
Hook and Loop Fastener Strips	257

Bits



	Bits for Phillips Screws	260
	Bits for Pozidriv Screws	271
	Bits for Plusminus Screws – Slotted/Phillips	279
	Bits for Plusminus Screws – Slotted/Pozidriv	279
	Bits for TORX® Screws	279
	Bits for TORX® B0 Screws	287
	Bits for TORX PLUS® Screws	289
	Bits for TORX PLUS® IPR Screw	290
	Bits for Slotted Screws	290
	Bits for Hexagon Socket Screws	293
	Bits for Hexagon Socket B0 Screws	298
	Bits for Square Socket Screws	300
	Bits for TORQ-SET® Screws	303
	Bits for TRI-WING® Screws	304
	Bits for Multi-Point Screws	304
	Bits for Microstix® Screws	304
	Bits for Spanner Screws	305
	Nutsetters	305
	Internal Thread Insertion Tool	307

Holders and Adaptors



Impaktor Bit Holders	310
Rapidaptor Bit Holders	311
Universal Bit Holders With Quick-Release Chuck	313
Universal Bit Holders With Retaining Ring	314
Universal Bit Holders With Stainless Steel Sleeve	314
Bit Holders With Adjustable Depth-Control Stop	316
Adaptors	316

Bit Sets



Bit-Checks Impaktor	322
Bit-Checks Stainless	325
Bit-Checks / Bit-Safes BiTorsion	326
Bit-Checks Diamond	329
Bit-Checks / Bit-Safes Universal	331
Bit-Checks Wood	338
Bit-Checks Metal	341
Bit Sets for Special Applications	342

Torque Tools



Series 7400 Kraftform Torque Screwdrivers with variable torque value adjustment	350
with a factory pre-set measurement value	354
adjustable to customer requirements within the specified measurement range	358
Series Torque-indicators	363
Series Click-Torque Adjustable Torque Wrenches with Reversible Ratchet	367
Adjustable Torque Wrenches for Right-Hand and Left-Hand Tightening	369
Adjustable Torque Wrenches for Insert Tools	370
Pre-set, Adjustable Torque Wrenches for Insert Tools	372
Insert Tools Series	373
Accessories	380
Safe-Torque torque wrenches and accessories	381

Impact Driver and Soft-faced Hammers



Impact Driver 90 Nm	383
Soft Faced Hammers	383

Index

Techlex	385
Code No. Index	389
Article No. Index	403





Screwdrivers

Kraftform Stainless - stainless steel to prevent rust

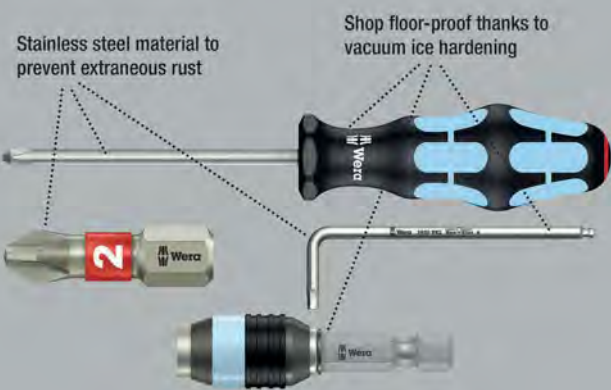

High quality Kraftform Plus screwdriver out of stainless steel. The stainless tools from Wera are vacuum ice-hardened and have the hardness and strength needed for screw connections. They can be used for industrial application without hesitation. The Lasertip tip literally bites into the head of the screw and thereby prevents any slipping out of the screw head. Multi-component Kraftform handle for fast and low-fatigue working.

Take it easy Tool Finder: colour coding according to profile and size. The hexagonal anti-roll feature prevents any bothersome rolling away at the workplace.

- Multi-component Kraftform handle for fast and ergonomic screwdriving
- Take it easy tool finder: colour coding according to profile and size
- Hexagonal anti-roll feature against rolling away
- Lasertip tips for more secure fit in the screw head

Lasertip - laser engineered blade



3335 Screwdriver for slotted screws, stainless

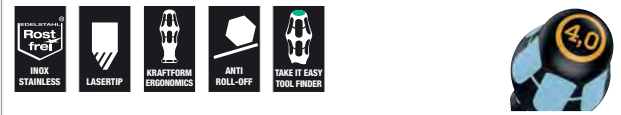

	EAN							
Code	4013288	mm	mm	mm	mm	mm	mm	
05032001001 ¹⁾	107329	0,5	3,0	3,0	80	81	1/8"	10
05032002001 ¹⁾	107336	0,6	3,5	3,5	100	81	9/64"	10
05032003001	107343	0,8	4,0	4,0	100	98	5/32"	10
05032004001	107350	1,0	5,5	5,5	125	98	7/32"	10

¹⁾ without Lasertip

3334 Screwdriver for slotted screws, stainless

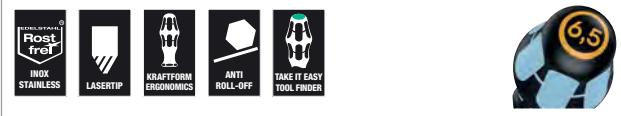

	EAN							
Code	4013288	mm	mm	mm	mm	mm	mm	
05032005001	107367	1,2	6,5	6,0	150	105	1/4"	10
05032006001	107374	1,2	8,0	7,0	175	112	5/16"	10
05032007001	107381	1,6	10,0	9,0	200	112	3/8"	5

3350 PH Screwdriver for Phillips screws, stainless

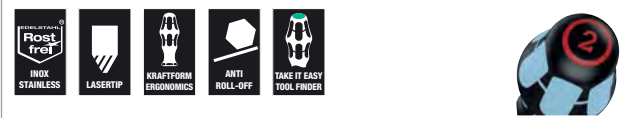

	EAN							
Code	4013288		mm	mm	mm	mm	mm	
05032020001 ¹⁾	107398	PH 0	60	81	3,0	2 3/8"		5
05032021001	107404	PH 1	80	98	4,5	3 1/8"		10
05032022001	107411	PH 2	100	105	6,0	4"		10
05032023001	107428	PH 3	150	112	8,0	6"		5

¹⁾ without Lasertip

3355 PZ Screwdriver for Pozidriv screws, stainless



	EAN						
Code	4013288		mm	mm	mm	"	
05032030001 ¹⁾	107435	PZ 0	60	81	3,0	2 3/8"	5
05032031001	107442	PZ 1	80	98	4,5	3 1/8"	10
05032032001	107459	PZ 2	100	105	6,0	4"	10
05032033001	107466	PZ 3	150	112	8,0	6"	5

¹⁾without Lasertip

3367 Screwdriver for TORX® screws, stainless



	EAN						
Code	4013288		mm	mm	mm	"	
05032050001	107473	TX 8	60	81	3,5	2 3/8"	10
05032051001	107480	TX 9	60	81	4,0	2 3/8"	10
05032052001	107497	TX 10	80	81	4,0	3 1/8"	10
05032053001	107503	TX 15	80	98	4,0	3 1/8"	10
05032054001	107510	TX 20	100	98	4,5	4"	10
05032055001	107527	TX 25	100	105	5,0	4"	10
05032056001	107534	TX 27	115	105	5,5	4 9/16"	10
05032057001	107541	TX 30	115	105	6,0	4 9/16"	10
05032058001	107558	TX 40	130	112	7,0	5 3/16"	10

3368 Screwdriver for square socket screws, stainless

- Stainless screwdriver for square socket screws
- Multi-component Kraftform handle for fast and ergonomic screwdriving
- Handle markings simplify finding and sorting of tools
- Hexagonal anti-roll feature against rolling away
- Stainless against extraneous rust

3368 Screwdriver for square socket screws, stainless



	EAN						
Code	4013288		mm	mm	mm	"	
05032070002	114150	# 1	80	98	4,5	3 1/8"	10
05032071002	114167	# 2	100	105	6,0	4"	10

3334/6 Screwdriver set, stainless and rack

- Storage rack for wall-mounting

3334/6 Screwdriver set, stainless and rack



	Code	EAN	
		4013288	
	05032060001	111388	1
		3350 PH 1x PH 1x80; 1x PH 2x100	
		3335 1x 0,5x3,0x80 ¹⁾ ; 1x 0,8x4,0x100; 1x 1,0x5,5x125	
		3334 1x 1,2x6,5x150	

¹⁾without Lasertip

3334/3355/6 Screwdriver set, stainless and rack

- Storage rack for wall-mounting

3334/3355/6 Screwdriver set, stainless and rack



	Code	EAN	
		4013288	
	05032061001	111395	1
		3355 PZ 1x PZ 1x80; 1x PZ 2x100	
		3335 1x 0,5x3,0x80 ¹⁾ ; 1x 0,8x4,0x100; 1x 1,0x5,5x125	
		3334 1x 1,2x6,5x150	

¹⁾without Lasertip

3334/3350/3355/6 Screwdriver set, stainless and rack

- Storage rack for wall-mounting

3334/3350/3355/6 Screwdriver set, stainless and rack



Code	EAN		
05032063001	111739		1
		+	3350 PH 1x PH 1x80; 1x PH 2x100
		+	3355 PZ 1x PZ 1x80; 1x PZ 2x100
		⊖	3335 1x 0,5x3,0x80 ¹⁾
		⊖	3334 1x 1,2x6,5x150

¹⁾without Lasertip

Wera Chiseldriver

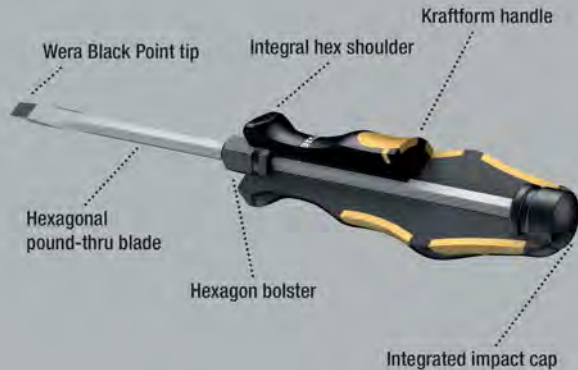

Wera Chiseldriver for fastening, chiselling and loosening seized screws. Multi-component Kraftform handle for fast and low-fatigue working. Kraftform Plus: hard gripping zones for high working speeds whereas soft zones ensure high torque transfer. A hexagon blade out of high quality bit material that extends right through the blade ensures full transfer of force, even when struck with a hammer.

The ductile tempered material prevents the blade from splintering or breaking. Comes with an impact cap for durability and reduced risk of splintering. More torque can be transferred with the help of an open-end or ring spanner applied to the integrated hexagonal bolster.

The Wera Black Point tip and a complex hardening process ensure a long service life of the tip, enhanced corrosion protection and an exact fit. The hexagonal anti-roll feature prevents any bothersome rolling away at the workplace.

932 A Screwdriver for slotted screws



	EAN	⊖	+	⬡	⊖	+	⊖	+
Code	4013288	mm	mm	mm	mm	mm	mm	mm
05018260001 ¹⁾	018007	0,6	3,5	4		80	81	10
05018262001	018014	0,8	4,5	5	8	90	98	10
05018264001	018021	1,0	5,5	6	10	100	105	10
05018266001	018038	1,2	7,0	6	10	125	105	10
05018268001	018045	1,6	9,0	8	13	150	112	10
05018270001	018052	1,6	10,0	8	13	175	112	5
05018272001 ²⁾	018069	2,0	12,0	10	16	200	117	2
05018274001 ²⁾	018076	2,5	14,0	10	16	250	117	2

¹⁾ No throughout blade, no impact cap and no hexagon bolster

²⁾ Kraftform with non-roll feature, single-component

932 A SB Screwdriver for slotted screws



Code	EAN		
05100085001	181596	⊖	932 A 1x 1.0x5.5x100
05100086001	181602	⊖	932 A 1x 1.2x7.0x125
05100087001	181619	⊖	932 A 1x 1.6x9.0x150

932 AS Screwdriver for slotted screws

- Hexagonal blade extending through the handle, impact cap with integrated square and bolster

932 AS Screwdriver for slotted screws



Code	EAN	⊖	+	⬡	⊖	+	⊖	+
05018300001	134486	0,8	4,5	5	8	100	98	10
05018301001	134462	1,0	5,5	6	10	113	105	10
05018302001	134455	1,2	7,0	6	10	138	105	10

917 SPH Screwdriver for Phillips screws



	EAN	+	Hexagon	Bolster	Blade	Blade	Blade	Blade	Blade
Code	4013288	+	mm	mm	mm	mm	mm	mm	mm
05017005001	017734	PH 1	5	8	80	98	3 1/8"	10	
05017010001	017741	PH 2	6	10	100	105	4"	10	
05017015001	017758	PH 3	8	13	150	112	6"	5	
05017020001	017765	PH 4	10	16	200	117	8"	2	

917 SPH SB Screwdriver for Phillips screws



Code	EAN	+	Blade	Blade	Blade	Blade	Blade	Blade
	4013288							
05100075001	181565	+	917 SPH	1x PH 1x80				10
05100076001	181572	+	917 SPH	1x PH 2x100				10
05100077001	181589	+	917 SPH	1x PH 3x150				5

917 SPHS Screwdriver for Phillips screws

- Hexagonal blade extending through the handle, impact cap with integrated square and bolster

917 SPHS Screwdriver for Phillips screws



	EAN	+	Hexagon	Bolster	Blade	Blade	Blade	Blade	Blade
Code	4013288	+	mm	mm	mm	mm	mm	mm	mm
05017040001	134493	PH 1	5	8	90	98	3 35/64"	10	
05017041001	134448	PH 2	6	10	113	105	4 29/64"	10	

918 SPZ Screwdriver for Pozidriv screws



	EAN	+	Hexagon	Bolster	Blade	Blade	Blade	Blade	Blade
Code	4013288	+	mm	mm	mm	mm	mm	mm	mm
05017050001	017772	PZ 1	5	8	80	98	3 1/8"	10	
05017052001	017789	PZ 2	6	10	100	105	4"	10	
05017054001	017796	PZ 3	8	13	150	112	6"	5	
05017056001	017802	PZ 4	10	16	200	117	8"	2	

918 SPZ SB Screwdriver for Pozidriv screws



Code	EAN	+	Blade	Blade	Blade	Blade	Blade	Blade
	4013288							
05100080001	181633	+	918 SPZ	1x PZ 1x80				10
05100081001	181640	+	918 SPZ	1x PZ 2x100				10
05100082001	181657	+	918 SPZ	1x PZ 3x150				5

977 Screwdriver for TORX® screws



	EAN	+	Hexagon	Bolster	Blade	Blade	Blade	Blade	Blade
Code	4013288	+	mm	mm	mm	mm	mm	mm	mm
05024400001	094742	TX 15	5	8	80	98	3 1/8"	10	
05024401001	094759	TX 20	5	8	90	98	3 1/2"	10	
05024402001	094766	TX 25	6	10	100	105	4"	10	
05024403001	094773	TX 27	6	10	125	105	5"	10	
05024404001	094780	TX 30	8	13	150	112	6"	10	
05024405001	094797	TX 40	8	13	150	112	6"	10	

Big Pack 900 Screwdriver set Kraftform Wera: Chiseldriver and rack

- Storage rack for wall-mounting

Big Pack 900 Screwdriver set Kraftform Wera: Chiseldriver and rack



Code	EAN		
05133285001	4013288 176349		1
		+	917 SPH 1x PH 1x80; 1x PH 2x100; 1x PH 3x150
		+	918 SPZ 1x PZ 1x80; 1x PZ 2x100; 1x PZ 3x150
		-	932 A 1x 0,6x3,5x80 ¹⁾ ; 1x 0,8x4,5x90; 1x 1,0x5,5x100; 1x 1,2x7,0x125; 1x 1,6x9,0x150
		*	977 TORX® 1x TX 20x90; 1x TX 25x100
			Rack 2x 190,0x50,0

¹⁾No throughout blade, no impact cap and no hexagon bolster

Kraftform 900/7 set 1 screwdriver set Kraftform Wera: The chiseldriver

- 7-piece set in compact, textile box with Wera 2go compatibility

Kraftform 900/7 set 1 screwdriver set Kraftform Wera: The chiseldriver



Code	EAN		
05137811001	4013288 217622		1
		+	917 SPH 1x PH 1x80; 1x PH 2x100
		*	977 TORX® 1x TX 20x90; 1x TX 25x100
		-	932 A 1x 0,8x4,5x90; 1x 1,0x5,5x100; 1x 1,2x7,0x125
			K240 1x 50,0x240,0

Kraftform 900/7 set 2 screwdriver set Kraftform Wera: The chiseldriver

- 7-piece set in compact, textile box with Wera 2go compatibility
- With Wera bottle opener

Kraftform 900/7 set 2 screwdriver set Kraftform Wera: The chiseldriver



Code	EAN		
05137812001	4013288 218162		1
		+	917 SPH 1x PH 1x80; 1x PH 2x100
		-	932 A 1x 0,6x3,5x80 ¹⁾ ; 1x 0,8x4,5x90; 1x 1,0x5,5x100; 1x 1,2x7,0x125
			Bottle opener 1x 145
			K240 1x 50,0x240,0

¹⁾No throughout blade, no impact cap and no hexagon bolster

Kraftform 900/7 set 3 screwdriver set Kraftform Wera: The chiseldriver

- 7-piece set in compact, textile box with Wera 2go compatibility
- With Wera bottle opener

Kraftform 900/7 set 3 screwdriver set Kraftform Wera: The chiseldriver



Code	EAN		
05137813001	4013288 218179		1
		+	918 SPZ 1x PZ 1x80; 1x PZ 2x100
		-	932 A 1x 0,6x3,5x80 ¹⁾ ; 1x 0,8x4,5x90; 1x 1,0x5,5x100; 1x 1,2x7,0x125
			Bottle opener 1x 145
			K240 1x 50,0x240,0

¹⁾No throughout blade, no impact cap and no hexagon bolster

932/6 Screwdriver set Krafftform Wera: Chiseldriver and rack

- Storage rack for wall-mounting

932/6 Screwdriver set Krafftform Wera: Chiseldriver and rack



Code		EAN		
		4013288		
05018282001	018090			1
		+	917 SPH 1x PH 1x80; 1x PH 2x100	
		-	932 A 1x 0,6x3,5x80 ¹⁾ ; 1x 0,8x4,5x90; 1x 1,0x5,5x100; 1x 1,2x7,0x125	

¹⁾No throughout blade, no impact cap and no hexagon bolster

932 S/6 Screwdriver set Krafftform Wera: Chiseldriver and rack

- Impact cap with integrated square and bolster for the transfer of higher torque
- Storage rack for wall-mounting

932 S/6 Screwdriver set Krafftform Wera: Chiseldriver and rack



Code		EAN		
		4013288		
05018283001	134479			1
		+	917 SPHS 1x PH 1x90; 1x PH 2x113	
		-	932 A 1x 0,6x3,5x80 ¹⁾	
		-	932 AS 1x 0,8x4,5x100; 1x 1,0x5,5x113; 1x 1,2x7,0x138	

¹⁾No throughout blade, no impact cap and no hexagon bolster

932/918/6 Screwdriver set Krafftform Wera: Chiseldriver and rack

- Storage rack for wall-mounting

932/918/6 Screwdriver set Krafftform Wera: Chiseldriver and rack



Code		EAN		
		4013288		
05018287001	018137			1
		+	918 SPZ 1x PZ 1x80; 1x PZ 2x100	
		-	932 A 1x 0,6x3,5x80 ¹⁾ ; 1x 0,8x4,5x90; 1x 1,0x5,5x100; 1x 1,2x7,0x125	

¹⁾No throughout blade, no impact cap and no hexagon bolster

977/6 TORX® Screwdriver set Krafftform Wera: Chiseldriver and rack

- Storage rack for wall-mounting

977/6 TORX® Screwdriver set Krafftform Wera: Chiseldriver and rack



Code		EAN		
		4013288		
05024410001	094803			1
		+	977 TORX® 1x TX 15x80; 1x TX 20x90; 1x TX 25x100; 1x TX 27x125; 1x TX 30x150; 1x TX 40x150	

Kraftform - the shape that adapts to the hand

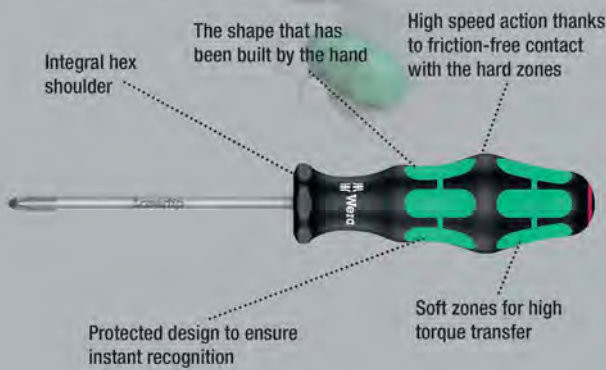

High quality Kraftform Plus screwdriver with electrician's blade. Multi-component Kraftform Plus handle for pleasant, ergonomic working that makes blisters and calluses a thing of the past. Hard gripping zones for high working speeds whereas soft zones ensure high torque transfer.

The tips of Wera Lasertip screwdrivers are microscopically roughened by means of laser beams. This rough surface literally bites into the head of the screw. Any unintentional slipping out is therefore prevented.

Take it easy tool finder with colour coding according to profiles and size stamp – for simple and rapid accessing of the required tool. The hexagonal anti-roll feature prevents any bothersome rolling away at the workplace and handle markings make for simplified finding and sorting of the tool.

- Smooth hard zones for high speed turning, soft grip zones for high torque transfer
- Take it easy tool finder: colour coding according to profile and size
- Hexagonal anti-roll feature against rolling away
- Lasertip tips for more secure fit in the screw head

Lasertip - laser engineered blade



335 Screwdriver for slotted screws



	EAN	┌	└	┆	┆	∅	└	┌
Code	4013288	mm	mm	mm	mm	mm	mm	
05008006001 ¹⁾	039996	0,4	2,0	60	70	2,5	5/64"	10
05110000001 ¹⁾	003232	0,4	2,5	60	70	2,5	3/32"	10
05008007001 ¹⁾	003249	0,4	2,5	75	70	2,5	3/32"	10
05110001001 ¹⁾	003256	0,5	3,0	80	81	3,0	1/8"	10
05008008001 ¹⁾	107985	0,5	3,0	150	81	4,0	1/8"	10
05008009001 ¹⁾	107992	0,5	3,0	200	81	4,0	1/8"	5
05008015001 ¹⁾	003263	0,6	3,5	100	81	3,5	9/64"	10
05110002001 ¹⁾	003270	0,6	3,5	125	81	3,5	9/64"	10
05110003001 ¹⁾	003287	0,6	3,5	200	81	3,5	9/64"	5
05110004001	003294	0,8	4,0	100	98	4,0	5/32"	10
05110005001	003300	0,8	4,0	150	98	4,0	5/32"	10
05110006001	003317	0,8	4,0	200	98	4,0	5/32"	5
05008027001 ¹⁾	003324	0,8	4,0	300	98	4,0	5/32"	2
05110007001	003331	1,0	5,5	125	98	5,5	7/32"	10
05008055001	003348	1,0	5,5	150	98	5,5	7/32"	10
05110008001	003355	1,0	5,5	200	98	5,5	7/32"	5
05008060001 ¹⁾	003362	1,0	5,5	300	98	5,5	7/32"	2
05008061001	108005	1,2	6,0	100	105	6,0	5/16"	10

¹⁾ without Lasertip

335 SB Slotted screwdriver



Code	EAN			
	4013288			
05100042001	181275	☉	335 1x 0.6x3.5x100 ¹⁾	10
05100043001	181251	☉	335 1x 0.8x4.0x100	10
05100044001	181244	☉	335 1x 1.0x5.5x125	10

334 SK Screwdriver for slotted screws

- Hexagonal blade and bolster for higher torque transfer

334 SK Screwdriver for slotted screws



	EAN							
Code	4013288	mm	mm	mm	mm	mm	mm	
05007670001 ¹⁾	108036	0,6	3,5	4	-	75	81	10
05007671001	108043	0,8	4,0	4	-	90	81	10
05007672001	108050	0,8	4,5	5	8	90	98	10
05007673001	108067	1,0	5,5	6	10	100	98	10
05007674001	108074	1,2	6,5	6	10	125	105	10
05007675001	108081	1,2	7,0	6	10	125	105	10
05007676001	108098	1,6	9,0	8	13	150	112	10
05007677001	108104	1,6	10,0	8	13	175	112	5

¹⁾without Lasertip

334 Screwdriver for slotted screws



	EAN								
Code	4013288	mm	mm	mm	mm	mm	mm	mm	
05007610001	003058	0,8	5,0	100	98	5,0	3/16"	10	
05007620001	003065	1,0	6,0	125	105	6,0	1/4"	10	
05340330001	102553	1,0	6,0	150	105	6,0	1/4"	10	
05110010001	003089	1,2	6,5	150	105	6,0	1/4"	10	
05007635001	003072	1,2	7,0	150	105	7,0	9/32"	10	
05007621001	108012	1,2	6,5	200	105	7,0	9/32"	5	
05110011001	003096	1,2	8,0	175	112	7,0	5/16"	5	
05007640001	108029	1,6	8,0	175	112	7,0	5/16"	5	
05110104001	003102	1,6	10,0	200	112	9,0	3/8"	5	
05110105001 ¹⁾	003119	2,0	12,0	250	117	10,0	1/2"	2	

¹⁾without Lasertip

334 SB Screwdriver for slotted screws



	EAN				
Code	4013288				
05100030001	181411		334	1x 1.2x6.5x150	10
05100031001	181220		334	1x 1.2x8.0x175	5

350 SK PH Screwdriver for Phillips screws

- Hexagonal blade and bolster for higher torque transfer

350 SK PH Screwdriver for Phillips screws



	EAN								
Code	4013288		mm	mm	mm	mm	mm	mm	
05008750001 ¹⁾	108128	PH 0	4		60	81	2 3/8"	5	
05008751001	108135	PH 1	5	8	80	98	3 1/8"	10	
05008752001	108142	PH 2	6	10	100	105	4"	10	
05008753001	108159	PH 3	8	13	150	112	6"	5	

¹⁾without Lasertip

350 PH Screwdriver for Phillips screws



	EAN							
Code	4013288		mm	mm	mm	mm	mm	
05008705001 ¹⁾	003591	PH 0	60	81	3,0	2 3/8"	5	
05008706001 ¹⁾	108111	PH 0	100	81	3,0	4"	5	
05008710001	003607	PH 1	80	98	4,5	3 1/8"	10	
05008712001	003614	PH 1	200	98	4,5	8"	2	
05008715001 ¹⁾	003621	PH 1	300	98	4,5	12"	2	
05008720001	003638	PH 2	100	105	6,0	4"	10	
05008723001	097996	PH 2	150	105	6,0	6"	10	
05008725001	003645	PH 2	200	105	6,0	8"	2	
05008730001 ¹⁾	003652	PH 2	300	105	6,0	12"	2	
05008735001	003669	PH 3	150	112	8,0	6"	5	
05008740001 ¹⁾	003676	PH 4	200	112	10,0	8"	2	

¹⁾without Lasertip

350 PH SB Screwdriver for Phillips screws



Code	EAN		
	4013288		
05100050001	181329	350 PH 1x PH 0x60 ¹⁾	10
05100051001	181336	350 PH 1x PH 1x80	10
05100052001	181343	350 PH 1x PH 2x100	10

¹⁾without Lasertip

355 SK PZ Screwdriver for Pozidriv screws

- Hexagonal blade and bolster for higher torque transfer

355 SK PZ Screwdriver for Pozidriv screws



Code	EAN								
	4013288		mm	mm	mm	mm			
05009340001 ¹⁾	108180		PZ 0	4		60	81	2 3/8"	5
05009341001	108197		PZ 1	5	8	80	98	3 1/8"	10
05009342001	108203		PZ 2	6	10	100	105	4"	10
05009343001	108210		PZ 3	8	13	150	112	6"	5

¹⁾without Lasertip

355 PZ Screwdriver for Pozidriv screws



Code	EAN							
	4013288		mm	mm	mm			
05009305001 ¹⁾	004024		PZ 0	60	81	3,0	2 3/8"	10
05009310001	004031		PZ 1	80	98	4,5	3 1/8"	10
05009312001	004048		PZ 1	200	98	4,5	8"	2
05009313001 ¹⁾	108166		PZ 1	300	98	4,5	12"	2
05009315001	004055		PZ 2	100	105	6,0	4"	10
05009317001	004062		PZ 2	200	105	6,0	8"	2
05347743001	097040		PZ 2	250	105	6,0	10"	2
05009319001 ¹⁾	108173		PZ 2	300	105	6,0	12"	2
05009320001	004079		PZ 3	150	112	8,0	6"	5
05009325001 ¹⁾	004086		PZ 4	200	112	10,0	8"	2

¹⁾without Lasertip

355 PZ SB Screwdriver for Pozidriv screws



Code	EAN			
	4013288			
05100055001	181282		355 PZ 1x PZ 0x60 ¹⁾	10
05100056001	181299		355 PZ 1x PZ 1x80	10
05100057001	181305		355 PZ 1x PZ 2x100	10

¹⁾without Lasertip

Hex-Plus - lets hexagon socket screws last longer

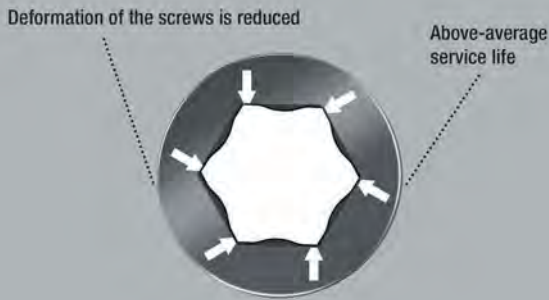

High quality Kraftform Plus screwdriver.

Multi-component Kraftform handle for fast and low-fatigue working. Kraftform Plus: hard gripping zones for high working speeds whereas soft zones ensure high torque transfer.

Hex-Plus offers a larger contact surface within the screw head. This reduces the notching effects to a minimum and almost completely eliminates the risk of destroying the screw recess.

Take it easy Tool Finder: colour coding according to profile and size. The hexagonal anti-roll feature prevents any bothersome rolling away at the workplace.

- Hexagonal screwdriver Hex-Plus
- Hex-Plus allows socket head screws to live longer

354 Screwdriver for hexagon socket screws



Code	EAN	⊘	┆	┆	∅	┆		
		mm	mm	mm	mm			
05023105001	003942	2,0	75	70	3,0	3"		5
05023107001	003959	2,5	75	81	3,0	3"		10
05023110001	003966	3,0	75	81	4,0	3"		10
05023115001	003973	4,0	75	98	5,0	3"		10
05023120001	003980	5,0	80	105	6,0	3 1/8"		10
05023125001	003997	6,0	80	105	7,0	3 1/8"		5
05023130001	004000	8,0	100	112	10,0	4"		5

352 Ball end screwdriver for hexagon socket screws

- Hexagonal blade and ballpoint for secure working even in difficult installation situations

352 Ball end screwdriver for hexagon socket screws



	EAN	⊘	⊘	┆	┆	┆		
		mm	mm	mm	mm	mm		
Code	4013288							
05022795001	0032577	1,5		60	70	2 3/8"		10
05022800001	003751	2,0		100	70	4"		10
05138070001	003768	2,5		100	81	4"		10
05022805001	003775	3,0		100	81	4"		10
05022810001	003782	4,0		100	98	4"		10
05022815001	003799	5,0		100	105	4"		10
05022820001	003805	6,0		125	105	5"		5
05022825001	003812	8,0		150	112	6"		5
05022830001	003829	10,0		150	112	6"		5
05022835001	003836	12,0		150	117	6"		5
05022905001	003843		5/32"	100	98	4"		5
05022910001	003850		3/16"	100	105	4"		5
05022920001	003874		1/4"	125	105	5"		5

TORX® Tools with holding function



High quality Kraftform Plus screwdriver.

Multi-component Kraftform handle for fast and low-fatigue working. Kraftform Plus: hard gripping zones for high working speeds whereas soft zones ensure high torque transfer.

Holding function: the wedging forces resulting from the contact pressure between the drive tip and the screw profile securely hold the screw on the tool.

The hexagonal anti-roll feature prevents any bothersome rolling away at the workplace. Handle markings for simplified finding and sorting of the tool.

- Screwdriver for recessed TORX® screws
- Holding function for TORX® screws
- Multi-component Kraftform handle for fast and ergonomic screw-driving
- Handle markings simplify finding and sorting of tools
- Hexagonal anti-roll feature against rolling away

367 TORX® HF Screwdriver with holding function for TORX® screws



Code	EAN		mm	mm	mm	mm	
05028048001	106643	TX 8	60	81	3,5	2 3/8"	10
05028049001	106650	TX 9	60	81	4,0	2 3/8"	10
05028050001	100696	TX 10	80	81	4,0	3 1/8"	10
05028051001	100702	TX 15	80	98	4,0	3 1/8"	10
05028052001	100719	TX 20	100	98	4,5	4"	10
05028070001	138415	TX 20	300	98	4,5	12"	4
05028053001	100726	TX 25	100	105	5,0	4"	10
05028071001	138408	TX 25	300	105	6,0	12"	4
05028054001	100733	TX 27	115	105	5,5	4 9/16"	10
05028072001	138392	TX 27	300	105	6,0	12"	4
05028055001	100740	TX 30	115	105	6,0	4 9/16"	10
05028073001	138385	TX 30	300	105	6,0	12"	4
05028056001	100757	TX 40	130	112	7,0	5 3/16"	10

367 Screwdriver for TORX® screws



Code	EAN		mm	mm	mm	mm	
05028000001	025852	TX 5	60	70	3,5	2 3/8"	10
05028001001	004185	TX 6	60	70	3,5	2 3/8"	10
05028002001	004192	TX 7	60	70	3,5	2 3/8"	10
05028003001	004208	TX 8	60	81	3,5	2 3/8"	10
05028004001	004215	TX 9	60	81	4,0	2 3/8"	10
05028005001	004222	TX 10	80	81	4,0	3 1/8"	10
05028008001	004239	TX 15	80	98	4,0	3 1/8"	10
05028010001	004246	TX 20	100	98	4,5	4"	10
05028012001	004253	TX 25	100	105	5,0	4"	10
05028013001	004260	TX 27	115	105	5,5	4 9/16"	10
05028015001	004277	TX 30	115	105	6,0	4 9/16"	10
05028020001	004284	TX 40	130	112	7,0	5 1/8"	10

367 SB Screwdriver for TORX® screws



Code	EAN			
05100060001	181350		367 TORX® 1x TX 10x80	10
05100061001	181367		367 TORX® 1x TX 15x80	10
05100062001	181374		367 TORX® 1x TX 20x100	10
05100063001	181381		367 TORX® 1x TX 25x100	10
05100064001	181398		367 TORX® 1x TX 30x115	10

367 TORX® BO Screwdriver for tamper-proof TORX® screws

High quality Kraftform Plus screwdriver. Multi-component Kraftform handle for fast and low-fatigue working.

TORX® BO screws have a protruding pin in their drive profile. This prevents any unauthorised loosening since the "normal" hex tools cannot move these screws. Only special TORX® BO tools have a bore hole which can slip over the pin.

The Wera Black Point tip and a complex hardening process ensure a long service life of the tip, enhanced corrosion protection and an exact fit.

The hexagonal anti-roll feature prevents any bothersome rolling away at the workplace. Handle markings for simplified finding and sorting of the tool.

- Screwdrivers for recessed TORX® screws with safety pin

367 TORX® BO Screwdriver for tamper-proof TORX® screws



Code	EAN						
	4013288		mm	mm	mm		
05138257001	039965	TX 7	60	70	3,5	2 3/8"	5
05138258001	039972	TX 8	60	81	3,5	2 3/8"	5
05138259001	039989	TX 9	60	81	4,0	2 3/8"	5
05138260001	025869	TX 10	80	81	4,0	3 1/8"	5
05138268001	108234	TX 10	300	81	4,0	12"	5
05138261001	025876	TX 15	80	98	4,0	3 1/8"	5
05138269001	108241	TX 15	300	98	4,0	12"	2
05138262001	025883	TX 20	100	98	4,5	4"	5
05138270001	108258	TX 20	300	98	4,5	12"	2
05138263001	025890	TX 25	100	105	5,0	4"	5
05138264001	025906	TX 27	115	105	5,5	4 9/16"	5
05138265001	025913	TX 30	115	105	6,0	4 9/16"	5
05138266001	025920	TX 40	130	112	7,0	5 3/16"	5

367 TORX PLUS® Screwdriver for TORX PLUS® screws

High quality Kraftform Plus screwdriver by Wera. TORX PLUS® profile: in comparison to "normal" TORX® profiles, the enlargement of the 6 torque-transferring flanks between the tool and screw is implemented by using an elliptical and not circular profile design.

This means that the power applied when fastening is spread across a larger surface area. Higher torque is transferred and the service life of the screw and tool is also enhanced. Multi-component Kraftform handle for rapid and convenient working.

Kraftform Plus: hard gripping zones for high working speeds whereas soft zones ensure high torque transfer. The Wera Black Point tip offers a perfect fit and optimised corrosion protection. The hexagonal non-roll feature prevents any annoying rolling away at the workplace. Handle markings for simplified finding and sorting of the tools.

367 TORX PLUS® Screwdriver for TORX PLUS® screws



Code	EAN						
	4013288		mm	mm	mm		
05028029001	041555	5 IP	60	70	3,5	2 3/8"	5
05028030001	040091	6 IP	60	70	3,5	2 3/8"	5
05028031001	040107	7 IP	60	70	3,5	2 3/8"	5
05028032001	040114	8 IP	60	70	3,5	2 3/8"	5
05028033001	040121	9 IP	60	81	4,0	2 3/8"	5
05028034001	040138	10 IP	80	81	4,0	3 1/8"	5
05028035001	040145	15 IP	80	98	4,0	3 1/8"	5
05028036001	040152	20 IP	100	98	4,5	4"	5
05028037001	040169	25 IP	100	105	5,0	4"	5
05028038001	040176	30 IP	115	105	6,0	4 9/16"	5

368 Screwdriver for square socket head screws

High quality Krafftform Plus screwdriver for square socket screws. The colour coding system allows the user to quickly find and identify the size needed. Multi-component Krafftform handle for fast and low-fatigue working.

The Wera Black Point tip offers optimised corrosion protection and an exact fit. The hexagonal anti-roll feature prevents any bothersome rolling away at the workplace. Handle markings for simplified finding and sorting of the tool.

368 Screwdriver for square socket head screws



Code	EAN							
	4013288			mm	mm	mm		
05117680001	028723		# 00	60	81	3,5	2 3/8"	5
05117681001	028730		# 0	60	81	4,0	2 3/8"	5
05117682001	028747		# 1	80	98	4,5	3 1/8"	5
05117683001	028754		# 1	200	98	4,5	8"	5
05117684001	028761		# 2	100	105	6,0	4"	5
05117685001	028778		# 2	200	105	6,0	8"	5
05117691001	040916		# 2	300	105	6,0	12"	2
05117686001	028785		# 3	150	112	8,0	6"	5
05117687001	028792		# 4	200	112	8,0	8"	5

368 SB Screwdriver for square socket head screws



Code	EAN			
	4013288			
05100070001	181404		368 1x # 1x80	5
05100071001	181428		368 1x # 2x100	5
05100072001	181435		368 1x # 3x150	5

338 Actuation tool for terminal blocks (spring cages)

- Special tool for unlocking contact springs in electrotechnical line terminals
- Due to the curved geometry, even terminal blocks that cannot be reached with normal screwdrivers can be operated
- Suitable for spring terminals with a conductor cross-section of up to 1.5 mm² and 2.5 to 4.0 mm²

338 Actuation tool for terminal blocks (spring cages)



Code	EAN						
	4013288	mm	mm	mm	mm	mm	
05008101001	225641	0,4	2,5	81	81	2,5	3/32"
05008102001	225788	0,6	3,5	81	81	3,5	9/64"

391 Hose clamp screwdriver

- Hose clamp screwdriver for hexagon head screws
- Flexible, circular blade

391 Hose clamp screwdriver



Code	EAN					
	4013288	mm	mm	mm		
05028148001	004703	6	167	98	6 9/16"	5
05028150001	004710	7	167	98	6 9/16"	5
05028152001	004727	8	167	98	6 9/16"	5

395 Nutdriver

- Nutsetter for hexagon head screws

395 Nutdriver



	EAN						
Code	4013288	mm	mm	mm	mm	mm	
05028205001	004734	3,0	125	98	5,0	5"	5
05028210001	004741	3,5	125	98	6,1	5"	5
05028215001	004758	4,0	125	98	6,9	5"	5
05028220001	004765	4,5	125	98	7,1	5"	5
05028225001	004772	5,0	125	98	8,1	5"	5
05028230001	004789	5,5	125	98	8,1	5"	5
05029405001	004796	6,0	125	98	9,1	5"	5
05029410001	004802	7,0	125	105	11,0	5"	5
05029415001	004819	8,0	125	105	12,1	5"	5
05029420001	004826	9,0	125	105	13,1	5"	5
05029425001	004833	10,0	125	112	14,1	5"	5
05029430001	004840	11,0	125	112	16,0	5"	5
05029435001	004857	12,0	125	112	17,1	5"	5
05029440001	004864	13,0	125	112	18,1	5"	5
05029445001	004871	14,0	125	112	19,1	5"	5
05029450001	004888	15,0	125	112	21,0	5"	5

395 HO Nutdriver

High quality nutsetter with hollow shaft by Wera. Hollow shaft for the fastening of threaded rods; only then can the threaded rod with nut slip into the hollow shaft. Multi-component Kraftform handle for high working speeds and particularly ergonomic screwdriving.

Kraftform Plus: hard gripping zones for high working speeds whereas soft zones ensure high torque transfer. Hexagonal anti-roll feature prevents any rolling away and handle markings make for simplified finding and sorting of the tool; for hexagon head screws.

- Nutsetter for hexagon head screws
- Hollow shaft for protruding threaded rods, chrome-plated

395 HO Nutdriver



	EAN							
Code	4013288	mm		mm	mm	mm	mm	
05029460001	108296	5,0		90	98	7,2	3 35/64"	5
05029461001	108302	5,5		90	98	7,2	3 35/64"	5
05029462001	108319	6,0		90	98	7,2	3 35/64"	5
05029463001	108326	7,0		90	105	7,2	3 35/64"	5
05029464001	108333	8,0		90	105	9,3	3 35/64"	5
05029465001	108340	10,0		90	112	9,3	3 35/64"	5
05029466001	108357	13,0		90	112	11,0	3 35/64"	5
05029501001	110503		3/16"	90	98	7,2	3 35/64"	5
05029502001	110510		1/4"	90	98	7,2	3 35/64"	5
05029503001	110527		5/16"	90	105	9,3	3 35/64"	5
05029504001	110534		11/32"	90	105	9,3	3 35/64"	5
05029505001	110541		3/8"	90	112	9,3	3 35/64"	5
05029506001	110558		7/16"	90	112	11,0	3 35/64"	5
05029507001	110565		1/2"	90	112	11,0	3 35/64"	5



Take it easy tool finder with color markings - for quick tool identification

Bits: Take it easy tool finder

Zyklop sockets: Take it easy tool finder

L-Keys: Take it easy tool finder

Joker: Take it easy tool finder

Especially small screwdrivers with short blades for hard to reach areas. The 2-component Kraftform handle with its practical combination of hard and soft zones allows for a firm grip and precise working.

The blades have all the benefits of the Wera Bit technology. Special surface treatment of the blades for high corrosion protection and optimum fitting accuracy in the screw.

The hexagonal anti-roll protection prevents annoying rolling away of bits in the workplace.

- Short compact shape for working in confined spaces
- Ergonomic 2-component Kraftform handle for precise work
- Blades with the benefits of the Wera Bit technology
- Hexagonal anti-roll feature against rolling away
- Take it easy tool finder: colour coding according to profile and size

335 Stubby/carburetor screwdriver



	EAN							
Code	4013288	mm	mm	mm	mm	mm	-	
05008840001	212115	0,6	3,5	24,5	54	3,5	9/64"	5
05008841001	212122	0,8	4,0	24,5	54	4,0	5/32"	5
05008842001	212139	1,0	5,5	24,5	54	5,5	7/32"	5
05008843001	212146	1,2	6,5	24,5	54	6,5	1/4"	5
05008844001	212153	1,2	8,0	24,5	54	8,0	5/16"	5

350 PH Phillips-head Stubby/carburetor screwdriver



	EAN								
Code	4013288		mm	mm	mm		mm		
05008850001	212160	PH 1	25	54	4,2	1"			5
05008851001	212177	PH 2	25	54	5,2	1"			5
05008852001	212184	PH 3	25	54	6,2	1"			5

355 PZ Phillips-head Stubby/carburetor screwdriver



	EAN								
Code	4013288		mm	mm	mm		mm		
05008853001	212191	PZ 1	25	54	4,5	1"			5
05008854001	212207	PZ 2	25	54	6,0	1"			5
05008855001	212214	PZ 3	25	54	8,0	1"			5

367 TORX® Stubby screwdriver



	EAN								
Code	4013288		mm	mm	mm		mm		
05008856001	212245	TX 10	25	54	3,4	1"			5
05008857001	212252	TX 15	25	54	3,7	1"			5
05008858001	212269	TX 20	25	54	4,0	1"			5
05008859001	212276	TX 25	25	54	4,5	1"			5
05008860001	212283	TX 27	25	54	5,1	1"			5
05008861001	212290	TX 30	25	54	5,6	1"			5
05008862001	212306	TX 40	25	54	-	1"			5

368 Stubby screwdriver for square head socket screws



	EAN							
Code	4013288			mm	mm	mm		
05008863001	212313		# 01	25	54	4,2	1"	5
05008864001	212320		# 02	25	54	4,2	1"	5

Kraftform Big Pack 300

- Screwdrivers for slotted, cross-recess Phillips and Pozidriv screws and TORX®

Kraftform Big Pack 300



Code	EAN		
05105630001	163622		1
		350 PH 1x PH 1x80; 1x PH 2x100; 1x PH 3x150	
		355 PZ 1x PZ 1x80; 1x PZ 2x100; 1x PZ 3x150	
		367 TORX® 1x TX 10x80; 1x TX 15x80; 1x TX 20x100; 1x TX 25x100; 1x TX 30x115	
		334 1x 1,2x6,5x150	
		335 1x 0,6x3,5x100 ¹⁾ ; 1x 0,8x4,0x100	
		Rack 2x 190,0x50,0	

¹⁾without Lasertip

Kraftform XXL

- For every application the right tool

Kraftform XXL



Code	EAN		
05051010001	139092		1
		350 PH 1x PH 1x80; 1x PH 2x100	
		355 PZ 1x PZ 1x80; 1x PZ 2x100	
		932 A 1x 1,0x5,5x100; 1x 1,2x7,0x125	
		334 1x 1,2x6,5x150	
		335 1x 0,8x4,0x100; 1x 1,0x5,5x125	
		160 i VDE 1x 0,4x2,5x80 ¹⁾ ; 1x 0,6x3,5x100 ¹⁾	
		247 1x 0,5x3,0x70	
		Rack 2x 190,0x50,0	

¹⁾without Lasertip

²⁾Product not available in the USA and Canada.



Kraftform XXL 2



Code	EAN			
05051011001	4013288 144225			1
		+	350 PH 1x PH 2x100	
		+	355 PZ 1x PZ 1x80; 1x PZ 2x100	
		-	932 A 1x 1,0x5,5x100; 1x 1,2x7,0x125	
		-	335 1x 0,8x4,0x100	
		+	367 TORX® 1x TX 15x80; 1x TX 20x100; 1x TX 25x100	
		-	160 i VDE 1x 0,4x2,5x80 ¹⁾ ; 1x 0,6x3,5x100 ¹⁾	
		-	247 1x 0,5x3,0x70	
			Rack 2x 190,0x50,0	

¹⁾ without Lasertip

²⁾ Product not available in the USA and Canada.

Kraftform XXL 3



Code	EAN			
05347106001	4013288 182388			1
		-	932 A 1x 1,0x5,5x100; 1x 1,2x7,0x125	
		+	350 PH 1x PH 1x80; 1x PH 2x100	
		-	334 1x 1,2x6,5x150	
		-	335 1x 0,8x4,0x100; 1x 1,0x5,5x125	
		□	368 1x # 1x80; 1x # 2x100	
		-	160 i VDE 1x 0,4x2,5x80 ¹⁾ ; 1x 0,6x3,5x100 ¹⁾	
			Rack 2x 190,0x50,0	

¹⁾ without Lasertip

Kraftform 2go 300

11 Kraftform screwdrivers; with Take it easy Toolfinder; in the Wera 2go 4 quiver; comes with an adjustable partition element for individual sectioning.

- Suitable for docking with the Wera 2go system

Kraftform 2go 300



Code	EAN			
05004313001	4013288 187833			1
			Wera 2go 4 1x 165,0x165,0x105,0	
		+	350 PH 1x PH 1x80; 1x PH 2x100	
		+	355 PZ 1x PZ 1x80; 1x PZ 2x100	
		+	367 TORX® 1x TX 10x80; 1x TX 15x80; 1x TX 20x100; 1x TX 25x100; 1x TX 30x115	
		-	334 SK 1x 0,8x4,5x90; 1x 1,2x7,0x125	
			K120 1x 50,0x120,0	

334 SK/6 Rack Screwdriver set Kraftform Plus Lasertip and rack

- Hexagonal blade and bolster for higher torque transfer

334 SK/6 Rack Screwdriver set Kraftform Plus Lasertip and rack



Code	EAN			
05007680001	4013288 111418			1
		+	350 SK PH 1x PH 1x80; 1x PH 2x100	
		-	334 SK 1x 0,6x3,5x75 ¹⁾ ; 1x 0,8x4,0x90; 1x 1,0x5,5x100; 1x 1,2x6,5x125	

¹⁾ without Lasertip

334/6 Rack Screwdriver set Kraftform Plus Lasertip and rack



Code	EAN			
	4013288			
05105650001	003133			1
			350 PH 1x PH 1x80; 1x PH 2x100	
			334 1x 1,2x6,5x150	
			335 1x 0,5x3,0x80 ¹⁾ ; 1x 0,8x4,0x100; 1x 1,0x5,5x125	

¹⁾without Lasertip

334/355 SK/6 Screwdriver set Kraftform Plus Lasertip and rack

- Hexagonal blade and bolster for higher torque transfer

334/355 SK/6 Screwdriver set Kraftform Plus Lasertip and rack



Code	EAN			
	4013288			
05007681001	111425			1
			355 SK PZ 1x PZ 1x80; 1x PZ 2x100	
			334 SK 1x 0,6x3,5x75 ¹⁾ ; 1x 0,8x4,0x90; 1x 1,0x5,5x100; 1x 1,2x6,5x125	

¹⁾without Lasertip

334/355/6 Rack Screwdriver set Kraftform Plus Lasertip and rack



Code	EAN			
	4013288			
05105656001	003140			1
			355 PZ 1x PZ 1x80; 1x PZ 2x100	
			334 1x 1,2x6,5x150	
			335 1x 0,5x3,0x80 ¹⁾ ; 1x 0,8x4,0x100; 1x 1,0x5,5x125	

¹⁾without Lasertip

335/350/355/6 Screwdriver set Kraftform Plus Lasertip and rack



Code	EAN			
	4013288			
05105622001	041616			1
			350 PH 1x PH 1x80; 1x PH 2x100	
			355 PZ 1x PZ 1x80; 1x PZ 2x100	
			335 1x 0,8x4,0x100; 1x 1,0x5,5x125	

335/350/355/3 Screwdriver set Kraftform Plus 300 mm-long blades

- Extra-long blade for low-lying working situations

335/350/355/3 Screwdriver set Kraftform Plus 300 mm-long blades



Code	EAN			
05347735002	120991			1
		335	1x 1,0x5,5x300 ¹⁾	
		350 PH	1x PH 2x300 ¹⁾	
		355 PZ	1x PZ 2x300 ¹⁾	

¹⁾without Lasertip

335/350/355/4 Screwdriver set Kraftform Plus Lasertip 200 mm-long blades

- Extra-long blade for low-lying working situations

335/350/355/4 Screwdriver set Kraftform Plus Lasertip 200 mm-long blades



Code	EAN			
05347736002	117397			1
		350 PH	1x PH 2x200	
		355 PZ	1x PZ 1x200; 1x PZ 2x200	
		335	1x 1,0x5,5x200	

335/350/367/7 Rack Screwdriver set Kraftform Plus Lasertip and rack



Code	EAN			
05320540001	094704			1
		350 PH	1x PH 2x100	
		355 PZ	1x PZ 1x80; 1x PZ 2x100	
		335	1x 0,8x4,0x100	
		367 TORX®	1x TX 15x80; 1x TX 20x100; 1x TX 25x100	

Kraftform 300/7 set 1 Screwdriver set Kraftform Plus

- 7-piece set in compact, textile box with Wera 2go compatibility

Kraftform 300/7 set 1 Screwdriver set Kraftform Plus



Code	EAN			
05105623001	217608			1
		350 PH	1x PH 1x80; 1x PH 2x100	
		355 PZ	1x PZ 2x100	
		367 TORX®	1x TX 15x80; 1x TX 20x100; 1x TX 25x100	
		335	1x 0,8x4,0x100	
		K240	1x 50,0x240,0	



Kraftform 300/7 set 2 Screwdriver set Kraftform Plus

- 7-piece set in compact, textile box with Wera 2go compatibility
- With Wera bottle opener

Kraftform 300/7 set 2 Screwdriver set Kraftform Plus



Code	EAN			
05105624001	4013288 218049			1
		+	350 PH 1x PH 1x80; 1x PH 2x100	
		-	335 1x 0,5x3,0x80 ¹⁾ ; 1x 0,8x4,0x100; 1x 1,0x5,5x125; 1x 1,2x6,0x100	
			Bottle opener 1x 145	
			K240 1x 50,0x240,0	

¹⁾without Lasertip

Kraftform 300/7 set 3 Screwdriver set Kraftform Plus

- 7-piece set in compact, textile box with Wera 2go compatibility
- With Wera bottle opener

Kraftform 300/7 set 3 Screwdriver set Kraftform Plus



Code	EAN			
05105625001	4013288 218056			1
		+	350 PH 1x PH 2x100	
		+	355 PZ 1x PZ 1x80; 1x PZ 2x100	
		-	334 SK 1x 1,2x6,5x125	
		-	335 1x 0,8x4,0x100; 1x 1,0x5,5x125	
			Bottle opener 1x 145	
			K240 1x 50,0x240,0	

Kraftform 300/7 set 4 Screwdriver set Kraftform Plus

- 7-piece set in compact, textile box with Wera 2go compatibility
- With Wera bottle opener

Kraftform 300/7 set 4 Screwdriver set Kraftform Plus



Code	EAN		
05105626001	4013288 218063		1
		+	350 PH 1x PH 1x80; 1x PH 2x100
		-	335 1x 0,8x4,0x100; 1x 1,0x5,5x125
		□	368 1x # 1x80; 1x # 2x100
			Bottle opener 1x 145
			K240 1x 50,0x240,0

367/7 TORX® HF Kraftform Plus Screwdriver set with holding function and rack

- Holding function for TORX® screws, chrome-plated

367/7 TORX® HF Kraftform Plus Screwdriver set with holding function and rack



Code	EAN		
05223161001	4013288 118226		1
		+	367 TORX® HF 1x TX 8x60; 1x TX 10x80; 1x TX 15x80; 1x TX 20x100; 1x TX 25x100; 1x TX 27x115; 1x TX 30x115

367/6 TORX® HF Kraftform Plus Screwdriver set with holding function and rack



Code	EAN		
05028059001	4013288 100764		1
		+	367 TORX® HF 1x TX 10x80; 1x TX 15x80; 1x TX 20x100; 1x TX 25x100; 1x TX 30x115; 1x TX 40x130

367/4 TORX® HF Kraftform Plus Screwdriver set with holding function and 300 mm-long blades

- Screwdriver for TORX® screws; holding function and extra-long 300 mm blade

367/4 TORX® HF Kraftform Plus Screwdriver set with holding function and 300 mm-long blades

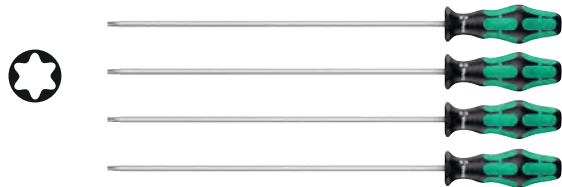

Code	EAN		
05028074001	4013288 138378		1
		+	367 TORX® HF 1x TX 20x300; 1x TX 25x300; 1x TX 27x300; 1x TX 30x300

367/6 TORX® Screwdriver set Kraftform Plus and rack



	Code	EAN		
	05028062001	4013288 028891		1
			367 TORX® 1x TX 10x80; 1x TX 15x80; 1x TX 20x100; 1x TX 25x100; 1x TX 30x115; 1x TX 40x130	

334/368/6 Screwdriver set and rack



	Code	EAN		
	05347778001	4013288 122735		1
			350 PH 1x PH 1x80; 1x PH 2x100	
			334 1x 1,2x6,5x150	
			335 1x 0,8x4,0x100	
			368 1x # 1x80; 1x # 2x100	

367/6 TORX® BO Kraftform Plus Screwdriver set and rack

- Screwdrivers for recessed TORX® screws with safety pin

367/6 TORX® BO Kraftform Plus Screwdriver set and rack



	Code	EAN		
	05138250001	4013288 028907		1
			367 TORX® BO 1x TX 10x80; 1x TX 15x80; 1x TX 20x100; 1x TX 25x100; 1x TX 30x115; 1x TX 40x130	

338/2 Set of actuation tools for terminal blocks (spring cages)

Set with 2 actuation tools for spring terminals. The curved blades also make it easy to operate spring terminals in distribution boxes which cannot be reached with a straight blade.

The blade stays in the terminal block, leaving both hands free to insert the wire. Multi-component Kraftform handle for fast and smooth work.

- Special tool for unlocking contact springs in electrotechnical line terminals
- Due to the curved geometry, even terminal blocks that cannot be reached with normal screwdrivers can be operated
- Suitable for spring terminals with a conductor cross-section of up to 1.5 mm² and 2.5 to 4.0 mm²

338/2 Set of actuation tools for terminal blocks (spring cages)



	Code	EAN		
	05008100001	4013288 225658		1
			338 1x 0,4x2,5x81; 1x 0,6x3,5x81	

395 HO/7 SM Nutdriver set

- Nutsetter for hexagon head screws
- Hollow shaft for protruding threaded rods, chrome-plated

395 HO/7 SM Nutdriver set



Code	EAN		
05029510001	111432		1
		● 395 HO 1x 5,0x90; 1x 5,5x90; 1x 6,0x90; 1x 7,0x90; 1x 8,0x90; 1x 10,0x90; 1x 13,0x90	

395 HO/3 Sanitary Nutdriver set

- Nutsetter for hexagon head screws, chrome-plated
- With hollow shaft for protruding threaded rods, particularly suitable for installing/removing mixer taps on washbasins

395 HO/3 Sanitary Nutdriver set



Code	EAN		
05134275001	207616		1
		● 395 HO 1x 10,0x90; 1x 13,0x90; 1x 7/16"x90	

391/3 Hose clamp screwdriver set

- Flexible, circular blade

391/3 Hose clamp Screwdriver set



Code	EAN		
05135311001	169860		1
		● 391 1x 6x167; 1x 7x167; 1x 8x167	

Stubby Set 1 Screwdriver set

Especially small screwdrivers with short blades for hard to reach areas. The 2-component Kraftform handle with its practical combination of hard and soft zones allows for a firm grip and precise working.

The blades have all the benefits of the Wera Bit technology. Special surface treatment of the blades for high corrosion protection and an optimum fit in the screw head.

The hexagon anti-roll protection prevents annoying rolling away of bits in the workplace.

- Short compact shape for working in confined spaces
- Ergonomic 2-component Kraftform handle for precise work
- Blades with the benefits of the Wera Bit technology
- Hexagonal anti-roll feature against rolling away
- Take it easy tool finder: colour coding according to profile and size

Stubby Set 1 Screwdriver set

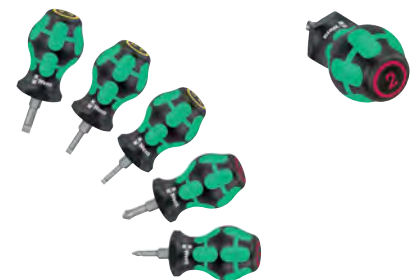

Code	EAN		
05008870001	212337		1
		● 335 Stubby 1x 0,6x3,5x24,5; 1x 0,8x4,0x24,5; 1x 1,0x5,5x24,5	
		⊕ 350 PH Stubby 1x PH 1x25; 1x PH 2x25	

Stubby Set 2 Screwdriver set



Code		EAN		
05008871001		4013288		
		212344		1
			335 Stubby 1x 0,6x3,5x24,5; 1x 0,8x4,0x24,5; 1x 1,0x5,5x24,5	
			355 PZ Stubby 1x PZ 1x25; 1x PZ 2x25	

Stubby Set 3 Screwdriver set

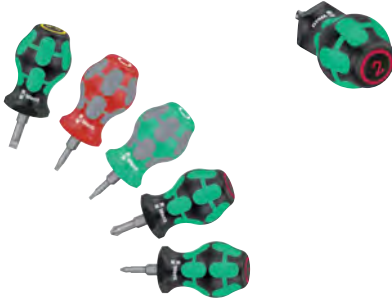

Code		EAN		
05008872001		4013288		
		214096		1
			350 PH Stubby 1x PH 1x25; 1x PH 2x25	
			335 Stubby 1x 1,0x5,5x24,5	
			368 Stubby 1x # 01x25; 1x # 02x25	

Stubby Set TX 1 Screwdriver set TORX®

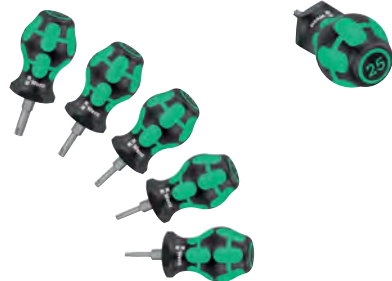

Code		EAN		
05008876001		4013288		
		212351		1
			367 TORX® Stubby 1x TX 10x25; 1x TX 15x25; 1x TX 20x25; 1x TX 25x25; 1x TX 30x25	

300/7 Mix 1 Screwdriver set

Application-specific mixture of workshop screwdrivers with normal long blade and especially small Stubby screwdrivers with short blade for hard to reach areas.

The 2-component Kraftform handle with its practical combination of hard and soft zones allows for a firm grip and precise working. The blades have all the benefits of the Wera Bit technology. Special surface treatment of the blades for high corrosion protection and an optimum fit in the screw head.

The hexagon anti-roll protection prevents annoying rolling away of bits in the workplace.

- Short compact Stubby screwdriver for working in confined spaces
- Lasertip screwdriver with long blade
- Ergonomic 2-component Kraftform handle for precise work
- Hexagonal anti-roll feature against rolling away
- Take it easy tool finder: colour coding according to profile and size

300/7 Mix 1 Screwdriver set



Code		EAN		
05008900001		4013288		
		214218		1
			350 PH Stubby 1x PH 1x25; 1x PH 2x25	
			350 PH 1x PH 1x80; 1x PH 2x100	
			334 1x 1,2x6,5x150	
			335 1x 0,5x3,0x80 ¹⁾ ; 1x 1,0x5,5x125	
			Rack 1x 190,0x50,0	

¹⁾without Lasertip

300/7 Mix 2 Screwdriver set



Code	EAN		
05008901001	4013288 214225		1
		⊕ 355 PZ Stubby 1x PZ 1x25; 1x PZ 2x25	
		⊕ 355 PZ 1x PZ 1x80; 1x PZ 2x200	
		⊖ 334 1x 1,2x6,5x150	
		⊖ 335 1x 0,5x3,0x80 ¹⁾ ; 1x 1,0x5,5x125	
		Rack 1x 190,0x50,0	

¹⁾without Lasertip

Bicycle Big Pack 1

Immediately find the suitable tool for many bicycle screws: Screwdriver all-round set with 7 T-handle screwdrivers, 5 Kraftform screwdrivers and 2 chiseldrivers with impact cap.

Kraftform Plus handle for comfortable ergonomic screwdriving, which avoids blisters and calluses.

Hard handle zones for high working speeds, while soft handle zones guarantee a high torque transfer. PH-screwdrivers with Lasertip: The tips of Wera Lasertip screwdrivers are microscopically roughened with laser beams.

This rough surface "bites" into the screw head and unintentional slipping is a thing of the past.

Take it easy tool finder with colour coding by profile and size stamping - to help you find the required tool quickly and easily. T-handles with holding function to hold the hexagonal socket screw securely on the tool.

- Bicycle tool set
- With 7 T-handle screwdrivers, 5 Kraftform screwdrivers and 2 chiseldrivers with impact cap
- T-handle screwdriver for the transmission of particularly high tightening and loosening moments
- T-handle screwdriver with holding function on the long arm for a secure hold of the screw on the tool
- PH screwdriver with Lasertip tip for better hold on the screw head

Bicycle Big Pack 1



Code	EAN		
05004190001	4013288 220745		1
		⊖ 354 Hex-Plus 1x 2,0x75; 1x 2,5x75	
		⊖ 454 HF 1x 3x100; 1x 4x150; 1x 5x150; 1x 6x200; 1x 8x200	
		⊕ 367 TORX® 1x TX 10x80	
		⊕ 467 TORX® HF 1x TX 20x100; 1x TX 25x200	
		⊖ 932 A 1x 1,0x5,5x100; 1x 1,2x7,0x125	
		⊕ 350 PH 1x PH 1x80; 1x PH 2x100	

1267 A TORX® Flagdriver for TORX® screws

High quality Wera flagdriver for recessed TORX® screws. High torque transfer for small screws. Particularly suitable for exchanging indexable inserts.

The BlackLaser surface treatment provides outstanding surface protection, even against corrosion, and a long service life. Multi-component for outstanding grip.

- TORX® flagdriver for recessed TORX® screws
- Multi-component handle
- Circular blade with BlackLaser treatment for outstanding surface protection and long service life
- High corrosion protection
- High torque transfer for small screws

1267 A TORX® Flagdriver for TORX® screws



Code	EAN	⊕	⊕	⊖	⊕	
	4013288		mm	mm	mm	
05026350001	093516	TX 6	33	62,0	3,0	1 19/64"
05026351001	093523	TX 7	33	62,0	3,0	1 19/64"
05026352001	093530	TX 8	40	69,0	3,0	1 37/64"
05026353001	093547	TX 9	40	69,0	3,0	1 37/64"
05026354001	093554	TX 10	40	69,0	3,0	1 37/64"

1267 A TORX PLUS® Flagdriver for TORX PLUS® screws



	EAN							
Code	4013288		mm	mm	mm			
05026360001	093561	6 IP	33	62,0	3,0	1 19/64"		10
05026361001	093578	7 IP	33	62,0	3,0	1 19/64"		10
05026363001	093608	9 IP	40	69,0	3,0	1 37/64"		10

1267 B TORX® combination flagdriver for TORX® and hexagon socket screws

High quality Wera flagdrivers with combination profiles for recessed TORX and socket head screws. High torque can be applied to small screws. Particularly suitable for the replacement of indexable inserts. The BlackLaser surface treatment provides outstanding surface protection, even against corrosion, and a long service life. Multi-component for an especially good grip.



	EAN						
Code	4013288		mm	mm	mm		
05026372001	093639	TX 15	3,5	47	86,0	1 27/32"	10
05026373001	093707	TX 15	4	47	86,0	1 27/32"	10
05026374001	093646	TX 20	4	47	86,0	1 27/32"	10

1267 B TORX PLUS® Combination flagdriver for TORX PLUS® and hexagon socket screws



	EAN						
Code	4013288		mm	mm	mm		
05026382001	093677	15 IP	3,5	47	86,0	1 27/32"	10

9500 Magnetiser SB

Wera magnetiser to magnetise and demagnetise tools to ensure the screw remains firmly on the blade.

- To magnetise and demagnetise tool tips
- To magnetise, move the tool tip along the positive side
- To demagnetise, move the tool tip along the negative side

9500 Magnetiser SB



	EAN		
Code	4013288	mm	
05033404001	219589	64,6	1

1427 Awl



	EAN				
Code	4013288	mm	mm		
05027405001	019998	105	92	4 3/16"	5

1428 Reamer



	EAN				
Code		mm	mm		
05027455001	020000	107	92	4 9/32"	5



Bicycle set 13

2-piece tyre lever set for the mobile and stationary use. Both tyre levers are made of glass fibre reinforced plastic: 9502 tyre lever with bit mounting, which is also suitable to secure the French valve, and 9503 tyre lever with valve ejector.

With the glass fibre reinforced plastic tyre levers, the tyres can be safely levered off the rim without damaging the rim.

- 2 tyre levers (9502+9503) made of glass fibre reinforced plastic
- Safely lever the tyres off of the rim without damaging the rim
- The 1/4" hexagon mounting in the 9502 tyre lever allows the fixing of French valves and the use of a 1/4" bit
- 9503 tyre lever with valve ejector and deflater

Bicycle set 13



Code	EAN		
05004184001	4013288 220585	9502 1x 105.0	5
		9503 1x 105.0	

Bicycle Set 15

The ultra compact and lightweight bike tools with two quadruple bits and three tyre levers. Four different screw profiles can be operated with just one bit.

Significant weight savings of over 50 %. The enormous space savings make the Bicycle Set 15 perfect for mobile use. The operability of the large profiles is made possible by the spring compression of the small tips. The bit with a 1/4" hexagon drive (Wera connection series 1) can also be used with e.g. bit ratchets and bitholding screwdrivers with Rapidaptor.

The 9504 tyre lever has a 1/4" mounting for using a 1/4" bit. When both 9504 tyre levers are stacked together, a 4-in-1 bit can be inserted and you get a screwdriving tool. The 9505 tyre lever serves as both valve ejector and bleeder valve. The levers and 4-in-1 bits can be clipped together, so that everything is compact and nothing will be lost.

Bicycle Set 15



Code	EAN		
05004182001	4013288 222190	9504 2x 105,0	1
		9505 1x 105,0	
		9506 1x 3,0; 4,0; 5,0; 6,0x37	
		9507 1x 2,5; 5,0; 6,0; TX 25x37	

Kraftform Micro - the electronic screwdriver

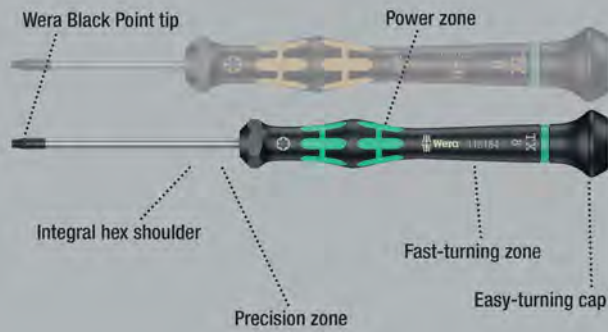

High quality Wera Micro screwdriver for precision mechanical jobs. Rapid twisting results from fixing the hand on the head and using the fast-turning zone just below.

This makes time-consuming grip adjustments unnecessary. Power zones with integrated soft sections ensure the transfer of high loosening and tightening torque; a precision zone for the right rotation angle during fine adjustment work.

The Black Point tip offers optimised corrosion protection and an exact fit. Take it easy tool finder with colour coding according to profiles and size stamp – for simple and rapid accessing of the required tool.

- Multi-component Kraftform Micro handle for fast and ergonomic screwdriving
- Anti-roll feature and swivel cap for rapid twisting
- The Wera Black Point tip offers an exact fit and optimum corrosion protection
- Take it easy tool finder: colour coding according to profile and size
- E.g. for electricians, opticians, precision mechanics, jewellers or IT hardware fitters

2055 Screwdriver for slotted screws for electronic applications



	EAN							
Code	4013288	mm	mm	mm	mm	mm		
05117990001	108418	0,16	0,8	40	97	2,0	1/32"	10
05117991001	108425	0,18	1,0	40	97	2,0	0,04"	10
05117992001	108432	0,20	1,2	40	97	2,0	0,05"	10
05118002001	031877	0,23	1,5	40	97	2,0	1/16"	10
05118003001	108456	0,23	1,5	60	97	2,0	1/16"	10
05118000001	031860	0,25	1,2	40	97	2,0	0,05"	10
05117993001	108463	0,30	1,8	40	97	2,0	0,07"	10
05118004001	031884	0,30	1,8	60	97	2,0	0,07"	10
05118017001	151704	0,30	2,0	50	97	2,0	0,07"	10
05117997001	194824	0,35	2,5	40	97	2,5	0,07"	10
05118005001	108470	0,40	2,0	40	97	2,5	5/64"	10
05118006001	031891	0,40	2,0	60	97	2,5	5/64"	10
05118007001	108487	0,40	2,0	100	97	2,5	5/64"	10
05117994001	108494	0,40	2,5	50	97	2,5	3/32"	10
05118008001	031907	0,40	2,5	80	97	2,5	3/32"	10
05117995001	108517	0,50	3,0	50	97	3,0	1/8"	10
05118010001	031914	0,50	3,0	80	97	3,0	1/8"	10
05118012001	031921	0,60	3,5	80	97	4,0	9/64"	10
05118014001	031938	0,80	4,0	80	97	4,0	5/32"	10

2055 PZ Screwdriver for Pozidriv screws for electronic applications



	EAN							
Code	4013288		mm	mm	mm			
05118030001	032195	PZ 0	60	97	3,0	2 3/8"		10
05118032001	032201	PZ 1	80	97	4,0	3 1/16"		10

2050 PH Screwdriver for Phillips screws for electronic applications



	EAN	+	⌀	ℓ	ℓ	ℓ	ℓ	
Code	4013288		mm	mm	mm	mm	mm	
05345290001 ¹⁾²⁾	164506	PH 000	40	97	1,5/2,5	1 9/16"		10
051180190001 ¹⁾²⁾	108562	PH 00	40	97	1,8/2,5	1 9/16"		10
051180200001 ¹⁾	031969	PH 00	60	97	2,5	2 3/8"		10
051180260001 ³⁾	194800	PH 0	40	97	3,0	1 9/16"		10
051180220001 ³⁾	031976	PH 0	60	97	3,0	2 3/8"		10
051180230001	108579	PH 1	60	97	4,0	2 3/8"		10
051180240001	031983	PH 1	80	97	4,0	3 1/8"		10

¹⁾ Optimised for Asian PH screws
²⁾ On the output side, the blade is turned to a nominal length of 10 mm.
³⁾ Size 0 modified according to JCS 0 (Japanese Camera Industrial Standard)

2067 TORX® HF Screwdriver with holding function for electronic applications

- Holding function for TORX® screws

2067 TORX® HF Screwdriver with holding function for electronic applications



	EAN	⊛	⌀	ℓ	ℓ	ℓ	ℓ	
Code	4013288		mm	mm	mm	mm	mm	
05118180001	108623	TX 4	40	97	2,5	1 9/16"		5
05118181001	108630	TX 5	40	97	3,0	1 9/16"		5
05118182001	108647	TX 6	40	97	3,0	1 9/16"		5
05118183001	108654	TX 7	60	97	3,0	2 3/8"		5
05118184001	108661	TX 8	60	97	3,0	2 3/8"		5
05118185001	108678	TX 9	60	97	4,0	2 3/8"		5
05118186001	108685	TX 10	60	97	4,0	2 3/8"		5

2067 TORX® Screwdriver for TORX® screws for electronic applications



	EAN	⊛	⌀	ℓ	ℓ	ℓ	ℓ	
Code	4013288		mm	mm	mm	mm	mm	
051180350001	108593	TX 1	40	97	2,0	1 9/16"		5
051180360001	108609	TX 2	40	97	2,0	1 9/16"		5
051180370001	108616	TX 3	40	97	2,0	1 9/16"		5
051180390001	040084	TX 4	40	97	2,5	1 9/16"		5
051180400001	032218	TX 5	40	97	3,0	1 9/16"		5
051180420001	032225	TX 6	40	97	3,0	1 9/16"		5

2067 TORX® BO Screwdriver for tamper-proof TORX® screws for electronic applications



	EAN	⊛	⌀	ℓ	ℓ	ℓ	ℓ	
Code	4013288		mm	mm	mm	mm	mm	
051180440001	032232	TX 7	60	97	3,0	1 9/16"		5
051180460001	032249	TX 8	60	97	3,0	2 3/8"		5
051180480001	032256	TX 9	60	97	4,0	2 3/8"		5
051180500001	032263	TX 10	60	97	4,0	2 3/8"		5
051180520001	032270	TX 15	60	97	4,0	2 3/8"		5
051180540001	032287	TX 20	60	97	4,0	2 3/8"		5

2067 IPR TORX PLUS® Screwdriver for electronic applications



	EAN	⊛	⌀	ℓ	ℓ	ℓ	ℓ	
Code	4013288		mm	mm	mm	mm	mm	
05030160001	178749	1 IPR	40	97	2,0	1 47/64"		5



Hex-Plus - lets hexagon socket screws last longer

Deformation of the screws is reduced

Above-average service life



- Kraftform Micro screwdriver for hexagon socket screws
- Hex-Plus allows socket head screws to live longer

2054 Screwdriver for hexagon socket screws for electronic applications



	EAN	⌀	⌀	⌈	⌈	⌀	⌈	📦
Code	4013288	mm		mm	mm	mm		
05118060001	032072	0,7		40	97	3,0	1 9/16"	5
05118062001	032089	0,9		40	97	3,0	1 9/16"	5
05118064001	032096	1,3		40	97	3,0	1 9/16"	5
05118066001	032102	1,5		60	97	3,0	2 3/8"	5
05118068001	032119	2		60	97	3,0	2 3/8"	5
05118070001	032126	2,5		60	97	4,0	2 3/8"	5
05118072001	032133	3,0		60	97	4,0	2 3/8"	5
05345284001	152206	-	0,028"	40	97	3,0	1 9/16"	5
05345285001	152213	-	0,035"	40	97	3,0	1 9/16"	5
05118074001	032140	-	0,05"	40	97	3,0	1 9/16"	5
05118076001	032157	-	1/16"	60	97	3,0	2 3/8"	5
05118078001	032164	-	5/64"	60	97	3,0	2 3/8"	5
05118080001	032171	-	3/32"	60	97	4,0	2 3/8"	5
05118082001	032188	-	7/64"	60	97	4,0	2 3/8"	5
05118075001	108807	-	1/8"	60	97	4,0	2 3/8"	5

2052 Ball end hexagon screwdriver for electronic applications

- Ballpoint for dependable working even in difficult installation situations

2052 Ball end hexagon screwdriver for electronic applications



	EAN	⌀	⌀	⌈	⌈	⌀	⌈	📦
Code	4013288	mm		mm	mm	mm		
05118089001	108814	1,3		60	97	3,0	2 3/8"	5
05118090001	031990	1,5		60	97	3,0	2 3/8"	5
05118092001	032003	2,0		60	97	3,0	2 3/8"	5
05118094001	032010	2,5		60	97	4,0	2 3/8"	5
05118096001	032027	3,0		60	97	4,0	2 3/8"	5
05118098001	032034	-	1/16"	60	97	3,0	2 3/8"	5
05118100001	032041	-	5/64"	60	97	3,0	2 3/8"	5
05118102001	032058	-	3/32"	60	97	3,0	2 3/8"	5
05118106001	110954	-	7/64"	60	97	4,0	2 3/8"	5
05118103001	108821	-	1/8"	60	97	4,0	2 3/8"	5

2072 Screwdriver for Microstix® screws



	EAN	⌀	⌈	⌈	⌀	⌈	📦
Code			mm	mm	mm		
05118145001	194817	m	40	97	2,5	1 9/16"	5

2069 Nutdriver for electronic applications



	EAN							
Code	4013288	mm	mm	mm	mm	mm	mm	
05118108001	108852	1,5	60	97	5,7	2 3/8"		5
05118109001	108869	1,8	60	97	5,7	2 3/8"		5
05118110001	032300	2,0	60	97	5,7	2 3/8"		5
05118112001	032317	2,5	60	97	5,7	2 3/8"		5
05118114001	032324	3,0	60	97	5,7	2 3/8"		5
05118116001	032331	3,2	60	97	5,7	2 3/8"		5
05118118001	032348	3,5	60	97	5,7	2 3/8"		5
05118120001	032355	4,0	60	97	5,7	2 3/8"		5
05118122001	032362	4,5	60	97	6,4	2 3/8"		5
05118124001	032379	5,0	60	97	7,0	2 3/8"		5
05118126001	032386	5,5	60	97	7,8	2 3/8"		5
05345281001	150189	6,0	60	97	8,5	2 3/8"		5
05118128001	032393	-	3/32"	60	97	5,7	2 3/8"	5
05118130001	032409	-	7/64"	60	97	5,7	2 3/8"	5
05118132001	032416	-	1/8"	60	97	5,7	2 3/8"	5
05118134001	032423	-	9/64"	60	97	5,7	2 3/8"	5
05118136001	032430	-	5/32"	60	97	5,7	2 3/8"	5
05118135001	110596	-	3/16"	60	97	6,6	2 3/8"	5
05118137001	112019	-	7/32"	60	97	7,8	2 3/8"	5
05345282001	150196	-	1/4"	60	97	9,0	2 3/8"	5

1429 Chip Removal Tool

- Lifting fork to remove firmly-fitted parts from a circuit board after desoldering

1429 Chip Removal Tool



	EAN						
Code	4013288	mm	mm	mm	mm		
05027456001	112187	1,0	3,5	50	97		10

1013 Kraftform Micro Bitholding screwdriver

Kraftform Micro holder with ergonomic Kraftform handle for fast and low-fatigue working.

The anti-roll feature prevents any bothersome rolling away at the workplace.

Suitable for take-up of bits with 4 mm halfmoon drive and bits with 4 mm HIOS drive. Ideal for applications on smartphones, cell phones, cameras, electronic equipment, in dental laboratories and dental surgeries.

- Kraftform Micro bit holder
- Multi-component Kraftform Micro handle with anti-roll feature and swivel cap
- Suitable for take-up of bits with 4 mm halfmoon drive and bits with 4 mm HIOS drive
- Applications e.g. on smartphones, mobile phones, cameras, electronic equipment

1013 Kraftform Micro Bitholding screwdriver

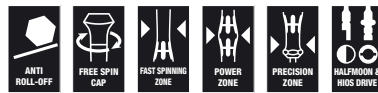

	EAN						
Code	4013288	mm	mm	mm			
05051276001	183699	23	97	1"			1



Kraftform Micro Big Pack 1 Screwdriver set for electronic applications

Wera Micro screwdriver set for fine mechanical screw connections. By supporting the hand on the rotating cap, and by the fast rotating zone below the rotating cap, lightning fast turning is possible.

Time-consuming hand switching is eliminated. Storage and transport in a robust roll-bag, so the correct tool is always at hand.

With Take it easy tool finder: colour coding by profile and size stamping.

- 25-piece Kraftform Micro screwdriver set in a robust and compact roll bag
- Kraftform Micro handle for fast and ergonomic working
- Tools with anti-roll protection and rotating cap for fast turning
- The Wera Black Point tip offers an exact fit and optimum corrosion protection
- Take it easy tool finder: colour coding according to profile and size
- Suitable for electricians, opticians, precision mechanics, jewellers or computer hardware engineers

Kraftform Micro Big Pack 1 Screwdriver set for electronic applications



Code	EAN		
0513400001	4013288 209580		1
		+	2050 PH Micro 1x PH 000x40 ^{1) 2)} ; 1x PH 00x40 ^{1) 2)} ; 1x PH 0x40 ³⁾
		*	2067 TORX® 1x TX 5x40; 1x TX 6x40
		*	2067 TORX® HF 1x TX 5x40; 1x TX 6x40; 1x TX 7x60; 1x TX 8x60; 1x TX 10x60
		*	2067 TORX PLUS® IPR Micro 1x 1 IPRx40
		○	2054 Micro 1x 0,9x40; 1x 1,3x40; 1x 1,5x60; 1x 2x60
		◐	2035 Micro 1x 0,23x1,5x40; 1x 0,30x1,8x60; 1x 0,35x2,5x40; 1x 0,40x2,0x60; 1x 0,50x3,0x80
		●	2069 Micro 1x 4,0x60; 1x 5,5x60
		▲	2072 1x mx40
		●	1429 1x 1,0x3,5x50
			K240 1x 50,0x240,0

¹⁾ Optimised for Asian PH screws

²⁾ On the output side, the blade is turned to a nominal length of 10 mm.

³⁾ Size 0 modified according to JCS 0 (Japanese Camera Industrial Standard)

Kraftform Micro 12 Universal 1 Screwdriver set for electronic applications

- Kraftform Micro set in a robust pouch

Kraftform Micro 12 Universal 1 Screwdriver set for electronic applications



Code	EAN		
05073675001	4013288 165695		1
		+	2050 PH Micro 1x PH 00x60 ¹⁾ ; 1x PH 0x60 ²⁾
		*	2067 TORX® HF 1x TX 5x40; 1x TX 6x40
		◐	2035 Micro 1x 0,23x1,5x40; 1x 0,30x1,8x60; 1x 0,40x2,0x60; 1x 0,40x2,5x80; 1x 0,50x3,0x80
		○	2054 Micro 1x 0,9x40; 1x 1,5x60; 1x 2x60

¹⁾ Optimised for Asian PH screws
²⁾ Size 0 modified according to JCS 0 (Japanese Camera Industrial Standard)



Kraftform Micro 12 Electronics 1 Screwdriver set for electronic applications

- Kraftform Micro screwdriver for slotted, Phillips, TORX® B0, Hex, IPR and Microstix® screws plus chip lifter

Kraftform Micro 12 Electronics 1 Screwdriver set for electronic applications



Code	EAN		
05073677001	4013288 194831		1
		⊕ 2050 PH Micro 1x PH 000x40 ^{1) 2)} ; 1x PH 00x40 ^{1) 2)} ; 1x PH 0x40 ³⁾	
		⊗ 2067 TORX® B0 Micro 1x TX 8x60; 1x TX 10x60	
		⊕ 2067 TORX PLUS® IPR Micro 1x 1 IPRx40	
		⊖ 2035 Micro 1x 0,23x1,5x40; 1x 0,35x2,5x40	
		⊙ 2069 Micro 1x 2,5x60; 1x 3,0x60	
		⊕ 2072 1x mx40	
		⊙ 1429 1x 1,0x3,5x50	

¹⁾ Optimised for Asian PH screws
²⁾ On the output side, the blade is turned to a nominal length of 10 mm.
³⁾ Size 0 modified according to JCS 0 (Japanese Camera Industrial Standard)

Kraftform Kompakt Micro 11 Electronics 1

Kraftform Kompakt Micro Set for precision mechanical applications; suitable for the take-up of bits with 4 mm halfmoon drive (Wera series 9) and bits with 4 mm HIOS drive (Wera series 21); handle/interchangeable blade system for rapid blade change; Kraftform Micro handle with twist cap and free-turning zone for rapid twisting, making any time-consuming repositioning of the fingers unnecessary; power zone with integrated soft zones for the transfer of higher tightening and loosening torque; precision zone directly above the blade for the right angle for adjustment work; comes with 10 bits for manual as well as power tool operations; rapid fixing of the bit: just push the bit into the insert for automatic locking and a secure fit.

To change the bit, simply push the sleeve forward and remove; free-turning sleeve for simple guidance of the tool during the screwdriving process.

Kraftform Kompakt Micro 11 Electronics 1



Code	EAN		
05073676001	4013288 194848		1
		⊙ 1013 Kraftform Micro 1x 97	
		⊕ 851/9 C 1x PH 000x44 ¹⁾ ; 1x PH 00x44 ¹⁾ ; 1x PH 0x44 ²⁾	
		⊗ 867/9 C TORX® 1x TX 8x44	
		⊕ 867/9 C TORX PLUS® 1x 3 IPx44	
		⊕ 867/9 IPR TORX® PLUS 1x 1 IPRx44	
		⊖ 800/9 C 1x 0,35x2,5x44	
		⊕ 872/9 1x mx44	
		⊙ 869/9 1x 2,5x44,0; 1x 3,0x44,0	

¹⁾ Optimised for Asian PH screws
²⁾ Size 0 modified according to JCS 0 (Japanese Camera Industrial Standard)

Kraftform Kompakt Micro 11 Universal 1



Code	EAN			
05135938001	178343			1
		1013 Kraftform Micro 1x 97		
		851/9 C 1x PH 00x44 ¹⁾ ; 1x PH 0x44 ²⁾ ; 1x PH 1x44 ¹⁾		
		840/9 C 1x 1,5x44; 1x 2,0x44		
		800/9 C 1x 0,23x1,5x44; 1x 0,40x2,0x44; 1x 0,50x3,0x44		
		867/9 C TORX® 1x TX 5x44; 1x TX 6x44		

¹⁾ Optimised for Asian PH screws

²⁾ Size 0 modified according to JCS 0 (Japanese Camera Industrial Standard)

2035/6 A Screwdriver set and rack for electronic applications

- With useful plastic rack

2035/6 A Screwdriver set and rack for electronic applications



Code	EAN			
05118150001	031945			1
		2050 PH Micro 1x PH 00x60 ¹⁾ ; 1x PH 0x60 ²⁾		
		2035 Micro 1x 0,30x1,8x60; 1x 0,40x2,0x60; 1x 0,40x2,5x80; 1x 0,50x3,0x80		

¹⁾ Optimised for Asian PH screws

²⁾ Size 0 modified according to JCS 0 (Japanese Camera Industrial Standard)

2035/6 B Screwdriver set and rack for electronic applications

- With useful plastic rack

2035/6 B Screwdriver set and rack for electronic applications



Code	EAN			
05118152001	031952			1
		2050 PH Micro 1x PH 0x60 ¹⁾ ; 1x PH 1x80		
		2035 Micro 1x 0,40x2,5x80; 1x 0,50x3,0x80; 1x 0,60x3,5x80; 1x 0,80x4,0x80		

¹⁾ Size 0 modified according to JCS 0 (Japanese Camera Industrial Standard)

2050/6 Screwdriver set and rack for electronic applications

- Kraftform Micro screwdriver for slotted, Phillips-Recess, IPR and Microstix® screws
- With useful plastic rack

2050/6 Screwdriver set and rack for electronic applications



Code	EAN			
05030181001	194794			1
		2050 PH Micro 1x PH 000x40 ^{1) 2)} ; 1x PH 00x40 ^{1) 2)} ; 1x PH 0x40 ³⁾		
		2067 TORX PLUS® IPR Micro 1x 1 IPRx40		
		2072 1x mx40		
		2035 Micro 1x 0,35x2,5x40		

¹⁾ Optimised for Asian PH screws

²⁾ On the output side, the blade is turned to a nominal length of 10 mm.

³⁾ Size 0 modified according to JCS 0 (Japanese Camera Industrial Standard)

2052/6 Hexagon Screwdriver set and rack for electronic applications

- Kraftform Micro screwdriver with ballpoint for hexagon socket screws

2052/6 Hexagon Screwdriver set and rack for electronic applications



Code	EAN			
05118156001	4013288 032065			1
			2052 Micro 1x 1,5x60; 1x 2,0x60; 1x 2,5x60; 1x 3,0x60	
			2054 Micro 1x 0,9x40; 1x 1,3x40	

2067/6 TORX® B0 Screwdriver set and rack for electronic applications

- Kraftform Micro screwdriver set for recessed TORX® screws with safety pin

2067/6 TORX® B0 Screwdriver set and rack for electronic applications



Code	EAN			
05118154001	4013288 032294			1
			2067 TORX® B0 Micro 1x TX 7x60; 1x TX 8x60; 1x TX 9x60; 1x TX 10x60; 1x TX 15x60; 1x TX 20x60	

2069/6 Screwdriver set and rack for electronic applications

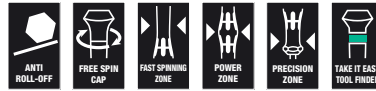

Code	EAN			
05118158001	4013288 032447			1
			2069 Micro 1x 2,0x60; 1x 2,5x60; 1x 3,0x60; 1x 3,5x60; 1x 4,0x60; 1x 5,0x60	

Series 400 T-Handle

The ergonomically shaped 2-component T-handle with finger recesses and pleasant surface facilitates very high power transmission and fatigue-free working.

Due to the special surface treatment, the blades receive a high level of corrosion protection. The optimum fitting accuracy of the screw is also guaranteed.

- T-handle screwdriver for the transmission of particularly high tightening and loosening moments
- Ergonomic 2-component handle with finger handle recesses and pleasant surface feel for very high power transmission and fatigue-free working.
- Take it easy tool finder: colour coding according to profile and size
- With additional short arm for the transmission of extremely high torques due to the leverage of the long arm

454 T-handle hexdriver

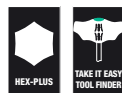

	EAN								
Code	4013288	mm	mm	mm	mm	mm	mm	mm	
05023330001	207753	2	100	12	32	65	4"	4"	5
05023332001	207814	2,5	100	12	32	65	4"	4"	5

454 HF T-handle hexagon screwdriver Hex-Plus with holding function



	EAN							
Code	4013288		mm	mm	mm	mm		
05023334001	207838	3	100	15	38	77		5
05023338001	207883	4	100	15	38	77		5
05023339001	207876	4	150	15	38	77		5
05023340001	207890	4	200	15	38	77		5
05023342001	207913	5	100	20	49	99		5
05023343001	207920	5	150	20	49	99		5
05023344001	207937	5	200	20	49	99		5
05023346001	207951	6	100	20	49	99		5
05023347001	207968	6	150	20	49	99		5
05023348001	207975	6	200	20	49	99		5
05023350001	208002	7	200	20	49	99		5
05023351001	208019	8	100	20	49	99		5
05023352001	208026	8	150	20	49	99		5
05023353001	208033	8	200	20	49	99		5
05023354001	208057	10	100	20	49	99		5
05023355001	208064	10	200	20	49	99		5

454 Imperial T-handle hexagon screwdriver Hex-Plus, imperial

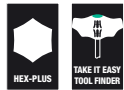

	EAN						
Code	4013288		mm	mm	mm	mm	
05023356001	214133	5/64"	150	12	32	65	5
05023357001	208071	3/32"	150	12	32	65	5
05023358001	208088	7/64"	150	12	32	65	5

454 HF T-handle hexagon screwdriver Hex-Plus with holding function, imperial

- With holding function (HF) on the long arm to securely hold the screw on the tool

454 HF T-handle hexagon screwdriver Hex-Plus with holding function, imperial



	EAN						
Code	4013288		mm	mm	mm	mm	
05023359001	208095	1/8"	150	15	38	77	5
05023360001	208101	9/64"	150	15	38	77	5
05023361001	208118	5/32"	150	15	38	77	5
05023362001	208125	3/16"	150	20	49	99	5
05023363001	208132	7/32"	150	20	49	99	5
05023364001	208149	1/4"	150	15	49	99	5
05023365001	208156	5/16"	150	20	49	99	5
05023366001	208163	3/8"	150	20	49	99	5

467 TORX® HF T-handle screwdriver with holding function

- With holding function (HF) on the long arm to securely hold the screw on the tool

467 TORX® HF T-handle screwdriver with holding function



	EAN							
Code	4013288		mm	mm	mm	mm	mm	
05023367001	208217	TX 6	100	12	32	65	3,0	5
05023368001	208224	TX 7	100	12	32	65	3,0	5
05023369001	208231	TX 8	100	12	32	65	3,5	5
05023370001	208248	TX 9	100	12	32	65	3,5	5
05023371001	208255	TX 10	100	12	32	65	4,0	5
05023372001	208262	TX 15	100	15	38	77	4,0	5
05023373001	208279	TX 20	100	15	38	77	4,5	5
05023374001	208286	TX 20	200	15	38	77	4,5	5
05023375001	208293	TX 25	100	15	38	77	5,0	5
05023376001	208309	TX 25	200	15	38	77	5,0	5
05023377001	208316	TX 27	200	20	49	99	6,0	5
05023378001	208323	TX 30	200	20	49	99	6,0	5
05023379001	208330	TX 40	200	20	49	99	8,0	5
05023380001	208347	TX 45	200	20	49	99	9,0	5

495 T-handle socket wrench screwdrivers



Code	EAN	Bit	mm	mm	mm	mm	mm	mm
05023381001	208354	5	230	38	77	9"		5
05023382001	208361	5,5	230	38	77	9"		5
05023383001	208378	6	230	38	77	9"		5
05023384001	208385	7	230	49	99	9"		5
05023385001	208392	8	230	49	99	9"		5
05023386001	208408	9	230	49	99	9"		5
05023387001	208415	10	230	49	99	9"		5
05023389001	208439	11	230	49	99	9"		5
05023391001	208477	12	230	49	99	9"		5
05023393001	208491	13	230	49	99	9"		5

Radidaptor - the amazing compact multifunction tool

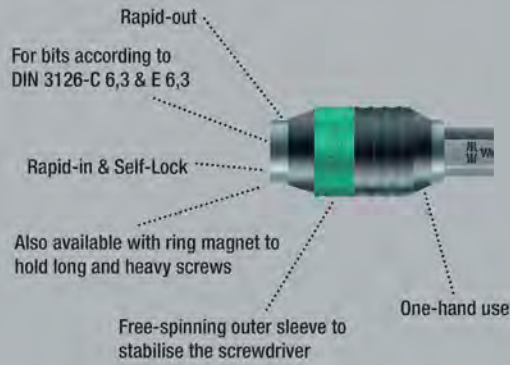

The ergonomically shaped 2-component T-handle with finger recesses and pleasant surface facilitates very high power transmission and fatigue-free working.

For bits with 1/4" hex head drive as per DIN ISO 1173-C 6.3 and E 6.3. With Radidaptor technology for lightning-fast bit changes.

- T-handle screwdriver for the transmission of particularly high tightening and loosening moments
- Ergonomic 2-component handle with finger handle recesses and pleasant surface feel for very high power transmission and fatigue-free working.
- With Radidaptor technology for lightning-fast bit changes
- Bitholders, magnetic, for easier application of the screw
- For bits with 1/4" external hexagon drive as per DIN ISO 1173-C 6.3 and E 6.3

416 R T-handle bitholding screwdriver Rapidaptor



Code	EAN	Bit	mm	mm	mm	mm	mm
05023404001	214157	1/4"	45	44	99	1 25/32"	2

416 RA T-handle bitholding screwdriver with ratchet function and Rapidaptor quick-release chuck

The integrated ratchet with fine toothing (80 teeth/return angle 4.5°) eases and accelerates screwdriving without having to reposition the tool. The ratchet mechanism completely embedded in the handle ensures very handy and comfortable work. With reversing lever for comfortable clockwise/counterclockwise direction change in one-hand operation.

The ergonomic shape of the handle fills the ball of the hand well, the fingers lie securely in the softly rounded recessed grips. The whole hand comes into contact with the handle, friction loss between hand and handle is avoided.

Bit holder for bits with 1/4" external hexagon drive as per DIN ISO 1173-C 6.3 and E 6.3. With Rapidaptor technology for lightning-fast bit changes.

- The integrated ratchet with fine toothing ensures fast and safe working
- Reversing lever for comfortable clockwise/counterclockwise direction change
- Convenient working thanks to the ratchet mechanism fully embedded in the handle
- Ergonomic 2-component handle with finger handle recesses and pleasant surface feel for very high power transmission and fatigue-free working
- Fast-rotating sleeve for extremely high working speed
- Rapidaptor bitholding screwdriver with fast-rotating sleeve for lightning-fast bit changes and high working speeds
- For bits with 1/4" external hexagon drive as per DIN ISO 1173-C 6.3 and E 6.3

416 RA T-handle bitholding screwdriver with ratchet function and Rapidaptor quick-release chuck



	EAN							
Code	4013288		mm	mm	mm			
05023461001	222824	1/4"	45	44	99	1 25/32"		2

411 A RA T-handle adapter screwdriver with ratchet function, 1/4"

The integrated ratchet with fine toothing (80 teeth/return angle 4.5°) eases and accelerates screwdriving without having to reposition the tool.

The ratchet mechanism completely embedded in the handle ensures very handy and comfortable work. With reversing lever for comfortable clockwise/counterclockwise direction change in one-hand operation.

The ergonomic shape of the handle fills the ball of the hand well, the fingers lie securely in the softly rounded recessed grips. The whole hand comes into contact with the handle, friction loss between hand and handle is avoided. 1/4" socket mounting with secure locking mechanism.

- The integrated ratchet with fine toothing ensures fast and safe working
- Reversing lever for comfortable clockwise/counterclockwise direction change
- Convenient working thanks to the ratchet mechanism fully embedded in the handle
- Ergonomic 2-component handle with finger handle recesses and pleasant surface feel for very high power transmission and fatigue-free working
- Fast-rotating sleeve for extremely high working speed
- 1/4" socket mounting with secure ball lock

411 A RA T-handle adapter screwdriver with ratchet function, 1/4"



	EAN							
Code	4013288		mm	mm	mm			
05023460001	222817	1/4"	45	44	99	1 25/32"		2

454/7 HF Set 1 screwdriver set T-handle screwdrivers Hex-Plus with holding function

- With holding function (HF) on the long arm to securely hold the screw on the tool

454/7 HF Set 1 screwdriver set T-handle screwdrivers Hex-Plus with holding function



Code	EAN		
05023450001	214829		1
		○ 454 1x 2,5x100	
		○ 454 HF 1x 3x100; 1x 4x100; 1x 5x150; 1x 6x150; 1x 8x200; 1x 10x200	
		Rack 2x 190,0x50,0	

454/7 HF Set 2 Screwdriver set T-handle Hex-Plus screwdrivers with holding function

- T-handle screwdriver for the transmission of particularly high tightening and loosening torque
- Ergonomic 2-component handle with finger handle recesses and pleasant surface feel for very high power transmission and fatigue-free working
- Take it easy tool finder: colour coding according to profile and size
- With additional short arm for the transmission of extremely high torques due to the leverage of the long arm
- With holding function (HF) on the long arm to securely hold the screw on the tool
- Including metal rack; the rack can be placed upright or hung on the tool wall.

454/7 HF Set 2 Screwdriver set T-handle Hex-Plus screwdrivers with holding function



Code	EAN		
05023453001	221742		1
		○ 454 1x 2,5x100	
		○ 454 HF 1x 3x100; 1x 4x100; 1x 5x150; 1x 6x150; 1x 8x200; 1x 10x200	
		9604 1x 214,0x78,0	



454/10 HF Set Imperial 1 screwdriver set T-handle screwdrivers Hex-Plus with holding function, imperial

- With holding function (HF) on the long arm to securely hold the screw on the tool

454/10 HF Set Imperial 1 screwdriver set T-handle screwdrivers Hex-Plus with holding function, imperial



Code	EAN		
05023451001	4013288 214836		1
		○ 454 Imperial 1x 3/32"x150; 1x 7/64"x150	
		○ 454 Imperial HF 1x 1/8"x150; 1x 9/64"x150; 1x 5/32"x150; 1x 3/16"x150; 1x 7/32"x150; 1x 1/4"x150; 1x 5/16"x150; 1x 3/8"x150	
		Rack 2x 190,0x50,0	

454/10 HF Set Imperial 2 Screwdriver set T-handle Hex-Plus screwdrivers with holding function, imperial

T-handle screwdriver: The ideal handle shape allows the transmission of particularly high tightening and loosening torque. The ergonomic shape of the handle fills the palm of the hand well, the fingers lie safely in the soft rounded handle recesses. The whole hand makes contact with the handle and friction losses between the hand and the handle are avoided.

With holding function to securely hold the hexagon socket screw on the tool. Special surface treatment of the blades for high corrosion protection and optimum fitting accuracy in the screw. Including metal rack for storage. The rack can be placed on the workbench or hung on the tool wall.

- Including metal rack; the rack can be placed upright or hung on the tool wall.

454/10 HF Set Imperial 2 Screwdriver set T-handle Hex-Plus screwdrivers with holding function, imperial



Code	EAN		
05023454001	4013288 221735		1
		○ 454 Imperial 1x 3/32"x150; 1x 7/64"x150	
		○ 454 Imperial HF 1x 1/8"x150; 1x 9/64"x150; 1x 5/32"x150; 1x 3/16"x150; 1x 7/32"x150; 1x 1/4"x150; 1x 5/16"x150; 1x 3/8"x150	
		9605 1x 214,0x78,0	

467/7 TORX® HF Set 1 screwdriver set T-handle TORX® screwdrivers with holding function

- With holding function (HF) on the long arm to securely hold the screw on the tool

467/7 TORX® HF Set 1 screwdriver set T-handle TORX® screwdrivers with holding function



Code	EAN		
05023452001	214874		1
		467 TORX® HF 1x TX 10x100; 1x TX 15x100; 1x TX 20x100; 1x TX 25x100; 1x TX 30x200; 1x TX 40x200; 1x TX 45x200	
		Rack 2x 190,0x50,0	

467/7 TORX® HF Set 2 Screwdriver set T-handle TORX® screwdrivers with holding function

T-handle screwdriver: The ideal handle shape allows the transmission of particularly high tightening and loosening torque. The ergonomic shape of the handle fills the palm of the hand well, the fingers lie safely in the soft rounded handle recesses. The whole hand makes contact with the handle and friction losses between the hand and the handle are avoided.

With holding function to securely hold the TORX® screw on the tool. Special surface treatment of the blades for high corrosion protection and optimum fitting accuracy in the screw. Including metal rack for storage. The rack can be placed on the workbench or hung on the tool wall.

- Including metal rack; the rack can be placed upright or hung on the tool wall.

467/7 TORX® HF Set 2 Screwdriver set T-handle TORX® screwdrivers with holding function



Code	EAN		
05023456001	221728		1
		467 TORX® HF 1x TX 10x100; 1x TX 15x100; 1x TX 20x100; 1x TX 25x100; 1x TX 30x200; 1x TX 40x200; 1x TX 45x200	
		9606 1x 214,0x78,0	



Bicycle set 6

10-piece T-handle screwdriver set for operations on the bike: The ideal handle shape allows the transmission of particularly high tightening and loosening moments. The ergonomic shape of the handle fills the ball of the hand well, the fingers lie securely in the softly rounded recessed grips.

The whole hand comes into contact with the handle and friction losses between hand and handle are avoided. With holding function at the long arm to hold the TORX® and hexagonal socket screws (from size 3) securely on the tool. Special surface treatment for high corrosion protection and optimal fitting accuracy in the screw.

With extra-short arm for the transmission of extremely high torques through the leverage of the long arm. Including metal rack for clearly arranged storage in the workshop.

- T-handle screwdriver for the transmission of particularly high tightening and loosening moments
- With holding function (HF) on the long arm to securely hold the screw on the tool
- With additional short arm for the transmission of extremely high torques due to the leverage of the long arm
- Take it easy tool finder: colour coding according to profile and size

Bicycle set 6



Code	EAN			
05004174001	4013288 220592			1
		⊙	454 1x 2,5x100	
		⊙	454 HF 1x 3x100; 1x 4x150; 1x 5x150; 1x 6x200; 1x 8x200; 1x 10x200	
		⊙	467 TORX® HF 1x TX 10x100; 1x TX 20x100; 1x TX 25x100	

9604 Metal rack for T-handle screwdrivers

Metal rack for T-handle screwdrivers. The rack can be placed on the workbench or hung on the tool wall.

For up to 7 Wera hexagonal socket T-handle screwdrivers.

- Metal rack for T-handle screwdrivers

9604 Metal rack for T-handle screwdrivers



	EAN	←	→	↑	↓					
Code	4013288	mm	mm							1
05136424001	223418	214,0	78,0							1

9605 Metal rack for T-handle screwdrivers

Metal rack for T-handle screwdrivers. The rack can be placed on the workbench or hung on the tool wall.

For up to 10 Wera hexagonal socket T-handle screwdrivers.

- For up to 10 hexagonal socket T-handle screwdrivers

9605 Metal rack for T-handle screwdrivers



	EAN	←	→	↑	↓					
Code	4013288	mm	mm							1
05136425001	223425	214,0	78,0							1

9606 Metal rack for T-handle screwdrivers

Metal rack for T-handle screwdrivers. The rack can be placed on the workbench or hung on the tool wall. For up to 7 Wera TORX® T-handle screwdrivers.

9606 Metal rack for T-handle screwdrivers



	EAN							
Code	4013288	mm	mm					
05136426001	223432	214,0	78,0					1

ESD Series

ESD-safe Micro screwdriver. Dependable protection against electrostatic energy and associated damage. Rapid twisting results from fixing the hand on the head and using the fast-twisting zone just below. This makes time-consuming grip adjustments unnecessary.

Power zones with integrated soft sections ensure the transfer of high loosening and tightening torque; a precision zone for the right rotation angle during fine adjustment work.

The Black Point tip offers optimised corrosion protection and an exact fit. Take it easy tool finder with colour coding according to profiles and size stamp – for simple and rapid accessing of the required tool.

- ESD-safe tool thanks to surface resistance of $\leq 10^9$ Ohm
- Multi-component Kraftform Micro handle for fast and ergonomic screwdriving
- The Wera Black Point tip offers an exact fit and optimum corrosion protection
- Take it easy tool finder: colour coding according to profile and size
- Anti-roll feature and swivel cap for rapid twisting

1578 A ESD Kraftform Micro screwdriver for slotted screws

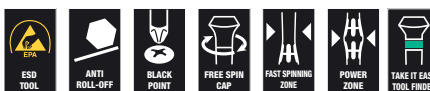

	EAN							
Code	4013288	mm	mm	mm	mm	mm		
05030099001	215253	0,16	0,8	40	97	2,0	1/32"	5
05030101001	039040	0,23	1,5	40	97	2,0	1/16"	5
05030100001	039033	0,25	1,2	40	97	2,0	0,05"	5
05030102001	039057	0,30	1,8	60	97	2,0	0,07"	5
05030108001	194763	0,35	2,5	40	97	2,5	3/32"	5
05030103001	039064	0,40	2,0	60	97	2,5	5/64"	5
05030104001	039071	0,40	2,5	80	97	2,5	3/32"	5
05030105001	039088	0,50	3,0	80	97	3,0	1/8"	5
05030106001	039095	0,60	3,5	80	97	4,0	9/64"	5
05030107001	039101	0,80	4,0	80	97	4,0	5/32"	5

1550 PH ESD Kraftform Micro screwdriver for Phillips screws



	EAN							
Code	4013288		mm	mm	mm	mm		
05030117001 ^{1) 2)}	194725	PH 000	40	97	1,5/2,5	1 9/16"		5
05030118001 ^{1) 2)}	194732	PH 00	40	97	1,8/2,5	1 9/16"		5
05030110001 ²⁾	039118	PH 00	60	97	1,8/2,5	2 3/8"		5
05030119001 ³⁾	194749	PH 0	40	97	3,0	1 9/16"		5
05030111001 ³⁾	039125	PH 0	60	97	3,0	2 3/8"		5
05030112001	039132	PH 1	80	97	4,0	3 1/8"		5

¹⁾ Optimised for Asian PH screws

²⁾ On the output side, the blade is turned to a nominal length of 10 mm

³⁾ Size 0 modified according to JCSIS 0 (Japanese Camera Industrial Standard)



1550 PH S ESD Kraftform Micro screwdrivers



	EAN	+	⌀	⌀	⌀		
Code	4013288		mm	mm			
05030109001	215222	# 01	40	97	1 9/16"		5

1555 PZ ESD Kraftform Micro screwdriver for Pozidriv screws



	EAN	*	⌀	⌀	⌀	⌀	
Code	4013288		mm	mm	mm		
05030115001	039149	PZ 0	60	97	3,0	2 3/8"	5
05030116001	039156	PZ 1	80	97	4,0	3 1/8"	5

TORX® Tools with holding function

Clamping force holds TORX® screw tight.



1567 TORX® HF ESD Kraftform Micro screwdriver with holding function for TORX® screws



	EAN	*	⌀	⌀	⌀	⌀	
Code	4013288		mm	mm	mm		
05030400001	183972	TX 4	40	97	2,5	1 9/16"	5
05030401001	183989	TX 5	40	97	3,0	1 9/16"	5
05030402001	183996	TX 6	40	97	3,0	1 9/16"	5
05030403001	184009	TX 7	60	97	3,0	2 3/8"	5
05030404001	184016	TX 8	60	97	3,0	2 3/8"	5
05030405001	184023	TX 9	60	97	4,0	2 3/8"	5
05030406001	184030	TX 10	60	97	4,0	2 3/8"	5

1567 TORX® ESD Kraftform Micro screwdriver for TORX® screws



	EAN	*	⌀	⌀	⌀	⌀	
Code	4013288		mm	mm	mm		
05030158001	215239	TX 2	40	97	2,0	1 9/16"	5
05030159001	215246	TX 3	40	97	2,0	1 9/16"	5
05030120001	039163	TX 4	40	97	2,5	1 9/16"	5
05030121001	039170	TX 5	40	97	3,0	1 9/16"	5
05030122001	039187	TX 6	40	97	3,0	1 9/16"	5

1567 TORX® BO ESD Kraftform Micro screwdriver for tamper-proof TORX® screws



	EAN	*	⌀	⌀	⌀	⌀	
Code	4013288		mm	mm	mm		
05030113001	219473	TX 6 BO	60	97	3,0	2 3/8"	5
05030114001	219480	TX 8 BO	60	97	3,0	2 3/8"	5

1567 IPR TORX PLUS® ESD screwdriver



	EAN	*	⌀	⌀	⌀	⌀	
Code	4013288		mm	mm	mm		
05030135001	194756	1 IPR	40	97	2,0	1 9/16"	5

1572 ESD Kraftform Micro screwdriver for Microstix® screws



	EAN						
Code	4013288		mm	mm	mm		
05030080001	181169	m	40	97	2,5	1 9/16"	5
05030081001	181176	00	40	97	2,5	1 9/16"	5
05030082001	181183	F	40	97	2,5	1 9/16"	5
05030083001	181190	0	40	97	2,5	1 9/16"	5
05030084001	181206	1	40	97	2,5	1 9/16"	5

1573 Pentalobe ESD Kraftform Micro screwdriver

- Kraftform Micro screwdriver for Pentalobe screws

1573 Pentalobe ESD Kraftform Micro screwdriver

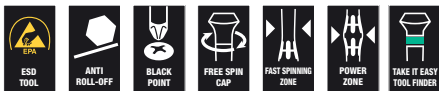

	EAN						
Code	4013288		mm	mm	mm		
05030330001	219435	PL 1,1	40	97	2,0	1 9/16"	5
05030331001	219497	PL 1,4	40	97	2,0	1 9/16"	5

1569 ESD Nutdriver

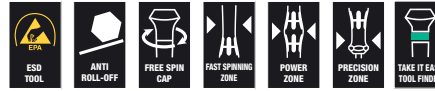

	EAN						
Code	4013288		mm	mm	mm		
05030410001	184047	1,5	60	97	5,7	2 3/8"	5
05030411001	184054	1,8	60	97	5,7	2 3/8"	5
05030412001	184061	2,0	60	97	5,7	2 3/8"	5
05030413001	184078	2,5	60	97	5,7	2 3/8"	5
05030414001	184085	3,0	60	97	5,7	2 3/8"	5
05030415001	184092	3,2	60	97	5,7	2 3/8"	5
05030416001	184108	3,5	60	97	5,7	2 3/8"	5
05030417001	184115	4,0	60	97	5,7	2 3/8"	5
05030418001	184122	4,5	60	97	6,4	2 3/8"	5
05030150001	093486	5,0	60	97	7,0	2 3/8"	5
05030151001	093493	5,5	60	97	7,8	2 3/8"	5

1529 ESD Chip Removal Tool

- Chip lifter to remove firmly-fitted parts from a circuit board after desoldering

1529 ESD Chip Removal Tool



	EAN					
Code	4013288	mm	mm	mm	mm	
05027450001	219428	1,0	3,5	50	97	10



Kraftform Micro ESD Big Pack 1 Screwdriver set for electronic applications

Electrostatically secured Wera Micro screwdriver 25-piece set. The included screw profiles are especially suitable for the use on mobile phones and tablets. Safe protection against electrostatic energy and associated damage.

By supporting the hand on the rotating cap, and by the fast rotating zone below the rotating cap, lightning fast turning is possible. Time-consuming hand switching is eliminated.

The power zone with integrated soft zones ensures the transmission of high tightening and loosening moments. Precision zone for correct rotation angles whilst adjusting.

The Black Point tip provides fitting accuracy and optimum corrosion protection.

Take it easy tool finder with size stamping and colour coding by profile to find the required tool quickly and easily. Storage and transport in a robust textile bag, so the tool is well protected and always close at hand.

- Included profiles especially suitable for servicing mobile phones, tablets and laptops/desktops
- Storage and transport in a robust textile bag, so the tool is well protected and always close at hand

Kraftform Micro ESD Big Pack 1 Screwdriver set for electronic applications



Code	EAN		
05134019001	4013288 219459		1
		⊕ 1550 PH ESD Micro 1x PH 00x40 ^{1) 2)} ; 1x PH 00x40 ^{1) 2)} ; 1x PH 0x40 ³⁾ ; 1x PH 1x80	
		⊕ 1550 PH S ESD Micro 1x # 01x40	
		⊕ 1567 TORX® HF ESD Micro 1x TX 8x60; 1x TX 10x60	
		⊕ 1567 TORX® ESD Micro 1x TX 2x40; 1x TX 3x40; 1x TX 4x40; 1x TX 5x40; 1x TX 6x40	
		⊕ 1567 TORX® BO ESD Micro 1x TX 6 BOx60; 1x TX 8 BOx60	
		⊕ 1567 TORX PLUS® IPR ESD 1x 1 IPRx40	
		⊕ 1572 ESD 1x mx40; 1x 00x40; 1x Fx40; 1x 0x40	
		⊕ 1573 Pentalobe ESD 1x PL 1,1x40; 1x PL 1,4x40	
		⊕ 1569 ESD 1x 3,0x60	
		⊖ 1578 A ESD Micro 1x 0,16x0,8x40; 1x 0,23x1,5x40	
		⊖ 1529 ESD 1x 1,0x3,5x50	

¹⁾ Optimised for Asian PH screws

²⁾ On the output side, the blade is turned to a nominal length of 10 mm

³⁾ Size 0 modified according to JCSIS 0 (Japanese Camera Industrial Standard)

Kraftform Micro 6 ESD Smartphone repair kit 1

Electrostatically secured Wera Micro screwdriver 6-piece set. The included screw profiles are especially suitable for use on mobile phones and tablets. Safe protection against electrostatic energy and associated damage.

By supporting the hand on the rotating cap, and by the fast rotating zone below the rotating cap, lightning fast turning is possible. Time-consuming hand switching is eliminated. The power zone with integrated soft zones ensures the transmission of high tightening and loosening moments. Precision zone for correct rotation angles whilst adjusting.

The Black Point tip provides fitting accuracy and optimum corrosion protection.

Take it easy tool finder with size stamping and colour coding by profile to find the required tool quickly and easily.

- Included profiles especially suitable for servicing mobile phones and tablets

Kraftform Micro 6 ESD Smartphone repair kit 1



Code	EAN			
05030182001	4013288 219411			1
			1550 PH ESD Micro 1x PH 00x40 ^{1) 2)} ; 1x PH 0x40 ³⁾	
			1567 TORX PLUS® IPR ESD 1x 1 IPRx40	
			1572 ESD 1x mx40	
			1550 PH S ESD Micro 1x # 01x40	
			1529 ESD 1x 1,0x3,5x50	

¹⁾ Optimised for Asian PH screws
²⁾ On the output side, the blade is turned to a nominal length of 10 mm
³⁾ Size 0 modified according to JCS 0 (Japanese Camera Industrial Standard)

1578 A/6 ESD Screwdriver set and rack for electronic applications

- Includes practical rack for tidy storage of the screwdrivers

1578 A/6 ESD Screwdriver set and rack for electronic applications



Code	EAN			
05030170001	4013288 113900			1
			1550 PH ESD Micro 1x PH 0x60 ¹⁾ ; 1x PH 1x80	
			1578 A ESD Micro 1x 0,23x1,5x40; 1x 0,25x1,2x40; 1x 0,30x1,8x60; 1x 0,40x2,5x80	

¹⁾ Size 0 modified according to JCS 0 (Japanese Camera Industrial Standard)

1550/6 ESD Screwdriver set and rack for electronic applications

- Includes practical rack for tidy storage of the screwdrivers

1550/6 ESD Screwdriver set and rack for electronic applications



Code	EAN			
05030180001	4013288 194787			1
			1550 PH ESD Micro 1x PH 000x40 ^{1) 2)} ; 1x PH 00x40 ^{1) 2)} ; 1x PH 0x40 ³⁾	
			1578 A ESD Micro 1x 0,35x2,5x40	
			1567 TORX PLUS® IPR ESD 1x 1 IPRx40	
			1572 ESD 1x mx40	

¹⁾ Optimised for Asian PH screws
²⁾ On the output side, the blade is turned to a nominal length of 10 mm.
³⁾ Size 0 modified according to JCS 0 (Japanese Camera Industrial Standard)

1013 Kraffform Micro ESD bitholding screwdriver

ESD-safe Wera tool. The Kraffform Micro ESD holder for dependable protection against electrostatic energy and associated damage. Electrical surface resistance of $\leq 10^9$ Ohm. Ergonomic Kraffform handle for pleasant and low-fatigue working.

Black anti-roll feature prevents any bothersome rolling away at the workplace. Suitable for the take-up of bits with 4 mm halfmoon drive and bits with 4 mm HIOS drive. Ideal for applications on smartphones, cell phones, cameras, electrical appliances, in dental labs and dental surgeries.

- Kraffform Micro ESD bit holder
- ESD-safe tool thanks to surface resistance of $\leq 10^9$ Ohm
- Multi-component Kraffform Micro handle with anti-roll feature and swivel cap
- Suitable for take-up of bits with 4 mm halfmoon drive and bits with 4 mm HIOS drive
- Applications e.g. on smartphones, mobile phones, cameras, electronic equipment

1013 Kraffform Micro ESD Bitholding screwdriver



Code	EAN	mm	mm	mm					
05300004001	168610	23	97	1"					1

Radidaptor - the amazing compact multifunction tool



- ESD bit holder for ESD-safe working
- Surface resistance of $\leq 10^9$ Ohm
- Multi-component Kraffform handle for fast and ergonomic screwdriving
- Hexagonal anti-roll feature against rolling away
- 1/4" hexagon take-up with Radidaptor quick-release chuck

816 R ESD Bitholding screwdriver, non-magnetic



Code	EAN	mm	mm	mm					
05051464001	103918	1/4"	119						2

813 R ESD Bitholding screwdriver, non-magnetic



Code	EAN	mm	mm	mm					
05051273001	103901	1/4"	90						2



Kraftform Kompakt 60 ESD

ESD-safe Wera tool. 16 bits. Includes bitholder 816 R ESD holder, multi-component for high working speeds and particularly ergonomic screwdriving. Dependable protection against electrostatic energy and associated damage.

Compact set that enables both manual as well as power tool operations. Simple sorting according to profile and size, easy bit removal and reinsertion; with belt clip, 18-piece.

- Suitable for manual and power tool operations
- Smooth hard zones for high speed turning, soft grip zones for high torque transfer
- Rapidaptor quick-release chuck
- Tough viscous bits for universal use
- In robust pouch

Kraftform Kompakt 60 ESD



Code	EAN		
05051043001	183934		1
		816 R ESD 1x 1/4"x119	
		851/4 Z PH 1x PH 1x89; 1x PH 2x89; 1x PH 3x89	
		855/4 Z PZ 1x PZ 1x89; 1x PZ 2x89; 1x PZ 3x89	
		867/4 Z TORX® B0 1x TX 10x89; 1x TX 15x89; 1x TX 20x89; 1x TX 25x89; 1x TX 30x89	
		840/4 Z Hex-Plus 1x 3,0x89; 1x 4,0x89; 1x 5,0x89; 1x 6,0x89	
		800/4 Z 1x 1,0x5,5x89	

Kraftform Kompakt Micro 21 ESD 1

Kraftform Kompakt Micro set for precision mechanical work. Suitable for the take-up of bits with 4 mm halfmoon drive (Wera series 9) and bits with 4 mm HIOS drive (Wera series 21). Electrical surface resistance of $\leq 10^9$ Ohm for secure protection against electrostatic charge.

Manufactured in accordance with DIN EN 61340-5-1. Compact handle/interchangeable blade system for fast blade change. Kraftform Micro handle with twist cap and free-turning zone for rapid twisting, making any time-consuming repositioning of the fingers unnecessary.

Power zone with integrated soft zones for the transfer of higher tightening and loosening torque. Precision zone directly above the blade for the right angle for adjustment work. Bits for manual as well as power tool operations. Rapid fixing of the bit: just push the bit into the insert for automatic locking and a secure fit. To change the bit, simply push the sleeve forward and remove. Free-turning sleeve for simple guidance of the tool during the screwdriving process.

Kraftform Kompakt Micro 21 ESD 1



Code	EAN		
05135973001	194855		1
		1013 Kraftform Micro ESD 1x 97	
		851/9 C 1x PH 000x44 ¹⁾ ; 1x PH 00x44 ¹⁾ ; 1x PH 0x44 ²⁾	
		867/9 C TORX® 1x TX 1x44; 1x TX 2x44; 1x TX 3x44; 1x TX 4x44; 1x TX 5x44	
		867/9 C TORX PLUS® 1x 1 IPx44; 1x 2 IPx44; 1x 3 IPx44; 1x 4 IPx44	
		867/9 IPR TORX® PLUS 1x 1 IPRx44	
		872/9 1x mx44; 1x 00x44; 1x Fx44; 1x 0x44	
		800/9 C 1x 0,23x1,5x44; 1x 0,35x2,5x44	
		869/9 1x 2,5x44,0	

¹⁾ Optimised for Asian PH screws

²⁾ Size 0 modified according to JCS 0 (Japanese Camera Industrial Standard)

Kraftform Kompakt Micro 20 ESD 1

- Bit holder suitable for the take-up of bits with 4 mm halfmoon or HIOS drive
- Handle out of material with a surface resistance of $\leq 10^9$ Ohm
- Handle/Interchangeable blade system for rapid exchange of the blade
- Kraftform Micro handle with swivel cap for rapid twisting
- Bits for manual as well as power tool operations

Kraftform Kompakt Micro 20 ESD 1



Code	EAN		
05073671001	169662		1
		1013 Kraftform Micro ESD 1x 97	
		851/9 C 1x PH 00x44 ¹⁾ ; 1x PH 0x44 ²⁾ ; 1x PH 1x44 ¹⁾	
		867/9 C TORX® 1x TX 1x44; 1x TX 2x44; 1x TX 3x44; 1x TX 4x44; 1x TX 5x44; 1x TX 6x44	
		867/9 C TORX PLUS® 1x 1 IPx44; 1x 2 IPx44; 1x 3 IPx44; 1x 4 IPx44	
		840/9 C 1x 1,5x44; 1x 2,0x44	
		800/9 C 1x 0,23x1,5x44; 1x 0,40x2,0x44; 1x 0,50x3,0x44	
		867/9 IPR TORX® PLUS 1x 1 IPRx44	

¹⁾Optimised for Asian PH screws

²⁾Size 0 modified according to JCIS 0 (Japanese Camera Industrial Standard)

Kraftform Kompakt Micro 11 ESD 1



Code	EAN		
05073670001	168344		1
		1013 Kraftform Micro ESD 1x 97	
		851/9 C 1x PH 00x44 ¹⁾ ; 1x PH 0x44 ²⁾ ; 1x PH 1x44 ¹⁾	
		867/9 C TORX® 1x TX 5x44; 1x TX 6x44	
		800/9 C 1x 0,23x1,5x44; 1x 0,40x2,0x44; 1x 0,50x3,0x44	
		840/9 C 1x 1,5x44; 1x 2,0x44	

¹⁾Optimised for Asian PH screws

²⁾Size 0 modified according to JCIS 0 (Japanese Camera Industrial Standard)

Kraftform Kompakt Stubby ESD 1

Handle/interchangeable blade system for lightning fast replacement of the required blade. Especially small ESD bit-holding Stubby screwdriver handle with short blade for electrostatically secure working even in hard to reach areas.

Suitable for the mounting of bits with 1/4" hexagon drive as per DIN ISO 1173-C 6.3 and Wera connection series 1. With strong permanent magnet, which also holds large and heavy screws.

The 2-component Kraftform handle with its practical combination of hard and soft zones allows for a firm grip and precise working. High-quality bits for universal use. Compact, textile box with high robustness, low weight and volume. Suitable for docking with the Wera 2go system.

- ESD bits hand holder for electrostatically safe working, magnetic
- 851/1 J: bits optimized for Asian PH screws

Kraftform Kompakt Stubby ESD 1



Code	EAN			
05057472001	214584			1
		●	811/1 Stubby ESD 1x 1/4"x54	
		+	851/1 Z PH 1x PH 0x25; 1x PH 1x25; 1x PH 2x25	
		+	851/1 J 1x PH 00x25x2,0 ¹⁾	
		-	800/1 Z 1x 0,5x3,0x25; 1x 0,6x4,5x25; 1x 1,0x5,5x25; 1x 1,2x6,5x25; 1x 1,2x8,0x25	

¹⁾ Size 00 modified according to JCIS 00 (Japanese Camera Industrial Standard)

809/1 ESD Stubby Bitholding screwdriver, with retaining ring

- Short compact shape for working in confined spaces
- Bit holder with retaining ring for bits with 1/4" hexagon drive

809/1 ESD Stubby Bitholding screwdriver, with retaining ring



	EAN						
Code	4013288		mm	mm			
05008882001	219206	1/4"	10	54	3/8"		2

811/1 ESD Stubby Bitholding screwdriver, magnetic

- Short compact shape for working in confined spaces
- Ergonomic 2-component Kraftform handle for precise work
- Hexagonal anti-roll feature against rolling away
- ESD bits hand holder for electrostatically safe working, magnetic
- For 1/4" bits as per DIN ISO 1173-C 6.3

811/1 ESD Stubby Bitholding screwdriver, magnetic



	EAN						
Code			mm	mm			
05008881001	212382	1/4"	10	54	3/8"		2

9514 ESD Magnetiser SB

Magnetiser. Simply pull the tool along the positive side of the Wera magnetiser and the tool will hold the screw securely on the blade.

To demagnetise, move the tool along the negative side.

- Magnetiser
- ESD-safe tool thanks to surface resistance of $\leq 10^9$ Ohm
- To magnetise and demagnetise tool tips
- Securely holds the screw on the tool

9514 ESD Magnetiser SB



Code	EAN	mm								
05073984001	225924	64,6								1

Kraftform Stainless - stainless steel to prevent rust

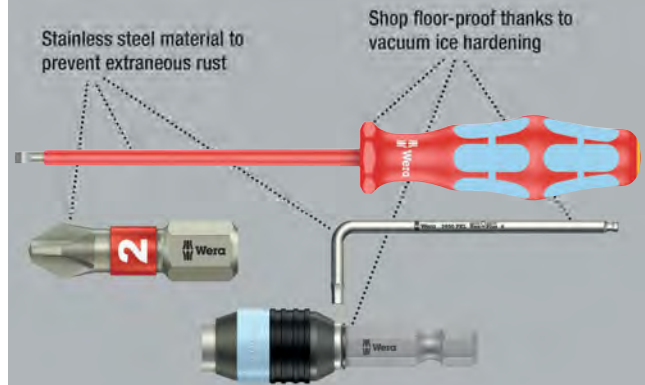

High quality Kraftform Plus VDE screwdriver out of stainless steel by Wera. The stainless tools from Wera are vacuum ice-hardened and have the hardness and strength needed for screw connections. They can be used for industrial application without hesitation.

The individual testing of the Kraftform Stainless VDE screwdrivers at 10,000 volts as per DIN EN 60900 (IEC 60900) ensures safe working with voltages of up to 1,000 volts. Secure working is also ensured under extreme conditions and verified with the proven cold impact resistance at -40° C. Kraftform handle for fast and low-fatigue working.

Take it easy Tool Finder: colour coding according to profile and size. The hexagonal anti-roll feature prevents any bothersome rolling away at the workplace.

Lasertip - laser engineered blade



3160 i VDE Insulated Screwdriver for slotted screws, stainless



	EAN							
Code	4013288	mm	mm	mm	mm			
05022729001 ¹⁾	122353	0,5	3,0	80	81	1/8"	3 1/8"	10
05022730001 ¹⁾	122148	0,6	3,5	100	81	9/64"	4"	10
05022731001	122155	0,8	4,0	100	98	5/32"	4"	10
05022732001	122162	1,0	5,5	125	98	7/32"	5"	10

¹⁾ without Lasertip

3162 i PH VDE Insulated Screwdriver for Phillips screws, stainless



	EAN				
Code	4013288		mm	mm	
05022733001	122179	PH 1	80	98	3 1/8"
05022734001	122186	PH 2	100	105	4"

3165 i PZ VDE Insulated Screwdriver for Pozidriv screws, stainless



	EAN				
Code	4013288		mm	mm	
05022740001	183941	PZ 1	80	98	3 1/8"
05022741001	183965	PZ 2	100	105	4"

3167 i VDE-isolated TORX® screwdriver, stainless steel



	EAN				
Code	4013288		mm	mm	
05022760001	220103	TX 8	80	81	3 1/8"
05022761001	220110	TX 9	80	81	3 1/8"
05022762001	220127	TX 10	80	81	3 1/8"
05022763001	220134	TX 15	80	98	3 1/8"
05022764001	220141	TX 20	80	98	3 1/8"
05022765001	220158	TX 25	100	105	4"
05022766001	220165	TX 30	100	105	4"

3160 i/7 Screwdriver set, stainless and rack

- Including useful rack for well-arranged storage of the screwdrivers

3160 i/7 Screwdriver set, stainless and rack

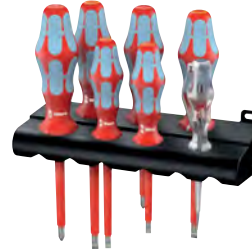

Code	EAN	
05022728001	4013288 118073	1
		3162 i VDE 1x PH 1x80; 1x PH 2x100
		3160 i VDE 1x 0,5x3,0x80 ¹⁾ ; 1x 0,6x3,5x100 ¹⁾ ; 1x 0,8x4,0x100; 1x 1,0x5,5x125
		3247 1x 0,5x3,0x70

¹⁾ without Lasertip

²⁾ Product not available in the USA and Canada.

3165 i/6 Screwdriver set, stainless and rack

- Including useful rack for well-arranged storage of the screwdrivers

3165 i/6 Screwdriver set, stainless and rack



Code	EAN	
05022745001	4013288 184207	1
		3165 i PZ VDE 1x PZ 1x80; 1x PZ 2x100
		3160 i VDE 1x 0,5x3,0x80 ¹⁾ ; 1x 0,6x3,5x100 ¹⁾ ; 1x 0,8x4,0x100; 1x 1,0x5,5x125

¹⁾ without Lasertip

3167 i/7 TORX® Screwdriver set, stainless and rack



Code		EAN		1
05022767001		4013288		
220172		220172		
		3167 i TORX® VDE		
		1x TX 8x80; 1x TX 9x80; 1x TX 10x80; 1x TX 15x80; 1x TX 20x80; 1x TX 25x100; 1x TX 30x100		

Kraftform 3100 i/7 set 1 Screwdriver set, stainless

- 6-piece VDE screwdriver set, stainless, in compact, textile box with Wera 2go compatibility
- With Wera bottle opener

Kraftform 3100 i/7 set 1 Screwdriver set, stainless



Code		EAN		1
05022750001		4013288		
218131		218131		
		3162 i VDE		
		1x PH 2x100		
		3165 i PZ VDE		
		1x PZ 1x80; 1x PZ 2x100		
		3160 i VDE		
		1x 0,6x3,5x100 ¹⁾ ; 1x 0,8x4,0x100; 1x 1,0x5,5x125		
		Bottle opener		
		1x 147		
		K240		
		1x 50,0x240,0		

¹⁾without Lasertip

Lasertip - laser engineered blade



Wera VDE screwdrivers with multi-component Kraftform Plus handle for fast and low-fatigue working: hard gripping zones for high working speeds whereas soft zones ensure high torque transfer. Individually tested at 10,000 volts for secure work at the permissible voltage of 1,000 volts.

The tips of the Wera Lasertip screwdrivers are microscopically roughened by laser beams. This rough surface literally bites into the head of the screw. Any unintentional slipping out is therefore a thing of the past.

Take it easy tool finder with colour coding according to profiles and size stamp – for simple and rapid accessing of the required tool. The hexagonal anti-roll feature prevents any bothersome rolling away at the workplace.

- Insulated blades for secure work at 1,000 volts
- Smooth hard zones for high speed turning, soft grip zones for high torque transfer
- Take it easy tool finder: colour coding according to profile and size
- Hexagonal anti-roll feature against rolling away
- Conical blade, Lasertip

160 i VDE Insulated screwdriver for slotted screws



Code	EAN	mm	mm	mm	mm	mm	mm	
05006100001 ¹⁾	027221	0,4	2,5	80	81	3/32"	3 1/8"	10
05006105001 ¹⁾	027238	0,5	3,0	100	81	1/8"	4"	10
05006110001 ¹⁾	027245	0,6	3,5	100	81	9/64"	4"	10
05006115001	027252	0,8	4,0	100	98	5/32"	4"	10
05006116001	105431	0,8	4,0	150	98	5/32"	6"	5
05006120001	027269	1,0	5,5	125	98	7/32"	5"	10
05006121001	105448	1,0	5,5	200	98	7/32"	8"	5
05006125001	027276	1,2	6,5	150	105	1/4"	6"	10
05006126001	105455	1,2	6,5	200	105	1/4"	8"	5
05006130001	027283	1,2	8,0	175	112	5/16"	7"	5
05006135001	028884	1,6	8,0	200	112	5/16"	8"	5
05006140001	028877	1,6	10,0	200	112	3/8"	8"	5

¹⁾without Lasertip

160 i SB VDE Insulated screwdriver for slotted screws

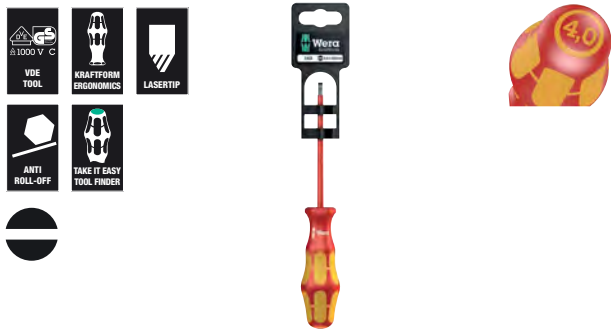

Code	EAN		
	4013288		
05100000001	181466	160 i VDE 1x 0.4x2.5x80 ¹⁾	10
05100001001	181473	160 i VDE 1x 0.5x3.0x100 ¹⁾	10
05100002001	181480	160 i VDE 1x 0.6x3.5x100 ¹⁾	10
05100003001	181497	160 i VDE 1x 0.8x4.0x100	10
05100004001	181503	160 i VDE 1x 1.0x5.5x125	10

¹⁾without Lasertip

160 iS VDE Insulated screwdriver with reduced blade diameter for slotted screws

- Reduced shaft diameter
- Allows screwdriving even in confined situations
- Low-lying screw and spring elements can be reached and actuated

160 iS VDE Insulated screwdriver with reduced blade diameter for slotted screws



Code	EAN	mm	mm	mm	mm	mm	mm	
05006440001	160089	0,6	3,5	100	81	9/64"	4"	10
05006441001	160102	0,8	4,0	100	98	5/32"	4"	10
05006442001	160126	1,0	5,5	125	98	7/32"	5"	10

160 iSS VDE Insulated screwdriver with reduced blade and handle diameter for slotted screws

- Reduced blade and handle diameter
- Allows screwdriving even in confined situations
- Low-lying screw and spring elements can be reached and actuated

160 iSS VDE Insulated screwdriver with reduced blade and handle diameter for slotted screws

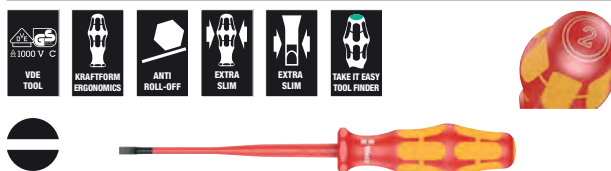

Code	EAN	mm	mm	mm	mm	mm	mm	
05020129001	179548	0,8	4,0	100	81	5/32"	4"	5

162 i PH VDE Insulated screwdriver for Phillips screws



Code	EAN	+	mm	mm	mm		
	4013288						
05006150001 ¹⁾	027290	PH 0	80	81	3 1/8"		5
05006152001	027306	PH 1	80	98	3 1/8"		5
05006153001	105417	PH 1	150	98	6"		5
05006154001	027313	PH 2	100	105	4"		5
05006159001	105424	PH 2	200	105	8"		5
05006156001	027320	PH 3	150	112	6"		5
05006158001 ¹⁾	027818	PH 4	200	112	8"		2

¹⁾without Lasertip

162 i PH SB VDE Insulated screwdriver for Phillips screws



Code	EAN	+					
	4013288						
05100011001	181442	+	162 i PH VDE 1x PH 1x80				5
05100012001	181459	+	162 i PH VDE 1x PH 2x100				5

162 iS PH VDE Insulated screwdriver with reduced blade diameter for Phillips screws

- Reduced shaft diameter
- Allows screwdriving even in confined situations
- Low-lying screw and spring elements can be reached and actuated

162 iS PH VDE Insulated screwdriver with reduced blade diameter for Phillips screws



Code	EAN	+	mm	mm	mm		
	4013288						
05006450001	160140	PH 1	80	98	3 1/8"		5
05006451001	160164	PH 2	100	105	4"		5

162 iSS PH VDE Insulated screwdriver with reduced blade diameter for Phillips screws

- Reduced blade and handle diameter
- Allows screwdriving even in confined situations
- Low-lying screw and spring elements can be reached and actuated

162 iSS PH VDE Insulated screwdriver with reduced blade diameter for Phillips screws



	EAN	+	⌀	⌀	⌀		
Code	4013288		mm	mm			
05020131001	179432	PH 1	80	81	3 1/8"		5
05020133001	179425	PH 2	100	98	4"		5

165 i PZ VDE Insulated screwdriver for Pozidriv screws



	EAN	+	⌀	⌀	⌀		
Code	4013288		mm	mm			
05006160001 ¹⁾	032782	PZ 0	80	81	3 1/8"		5
05006162001	029836	PZ 1	80	98	3 1/8"		5
05006163001	105462	PZ 1	150	98	6"		5
05006164001	029843	PZ 2	100	105	4"		5
05006165001	105479	PZ 2	200	105	8"		5
05006166001	029850	PZ 3	150	112	6"		5
05006168001 ¹⁾	029867	PZ 4	200	112	8"		2

¹⁾without Lasertip

165 i PZ SB VDE Insulated screwdriver for Pozidriv screws



Code	EAN	+				
05100015001	181510	+	165 i PZ VDE	1x PZ 1x80		5
05100016001	181527	+	165 i PZ VDE	1x PZ 2x100		5

165 iS PZ VDE Insulated screwdriver with reduced blade diameter for Pozidriv screws

- Reduced shaft diameter
- Allows screwdriving even in confined situations
- Low-lying screw and spring elements can be reached and actuated

165 iS PZ VDE Insulated screwdriver with reduced blade diameter for Pozidriv screws

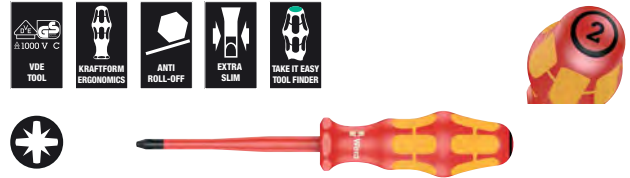

	EAN	+	⌀	⌀	⌀		
Code	4013288		mm	mm			
05006460001	160188	PZ 1	80	98	3 1/8"		5
05006461001	160249	PZ 2	100	105	4"		5

162 i PH/S VDE Insulated screwdriver for PlusMinus screws (Phillips/slotted)

- Combination profile Phillips/slotted

162 i PH/S VDE Insulated screwdriver for PlusMinus screws (Phillips/slotted)



	EAN	+	⌀	⌀	⌀		
Code	4013288		mm	mm			
05006380001	102614	# 1	80	98	3 1/8"		5
05006381001	102621	# 2	100	105	4"		5

162 i PH/S SB VDE Insulated screwdriver for PlusMinus screws (Phillips/slotted)



Code	EAN	+				
05100019001	186560	+	162 i PH/S VDE	1x # 1x80		5
05100020001	186577	+	162 i PH/S VDE	1x # 2x100		5

162 iS PH/S VDE Insulated screwdriver with reduced blade diameter for PlusMinus screws (Phillips/slotted)

- Reduced shaft diameter: combination profile Phillips/slotted
- Allows screwdriving even in confined situations
- Low-lying screw and spring elements can be reached and actuated

162 iS PH/S VDE Insulated screwdriver with reduced blade diameter for PlusMinus screws (Phillips/slotted)



	EAN	+	mm	mm	mm		
Code	4013288						
05006455001	160201	# 1	80	98	3 1/8"		5
05006456001	160225	# 2	100	105	4"		5

165 i PZ/S VDE Insulated screwdriver for PlusMinus screws (Pozidriv/slotted)

- Combination profile Pozidriv/slotted

165 i PZ/S VDE Insulated screwdriver for PlusMinus screws (Pozidriv/slotted)



	EAN	+	mm	mm	mm		
Code	4013288						
05006190001	102638	# 1	80	98	3 1/8"		5
05006191001	102645	# 2	100	105	4"		5

165 i PZ/S SB VDE Insulated screwdriver for PlusMinus screws (Pozidriv/slotted)



	EAN						
Code	4013288						
05100021001	186584	+	165 i PZ/S VDE				5
			1x # 1x80				
05100022001	186591	+	165 i PZ/S VDE				5
			1x # 2x100				

165 iS PZ/S VDE Insulated screwdriver with reduced blade diameter for PlusMinus screws (Pozidriv/slotted)

- Reduced shaft diameter: combination profile Pozidriv/slotted
- Allows screwdriving even in confined situations
- Low-lying screw and spring elements can be reached and actuated

165 iS PZ/S VDE Insulated screwdriver with reduced blade diameter for PlusMinus screws (Pozidriv/slotted)



	EAN	+	mm	mm	mm		
Code	4013288						
05006465001	160263	# 1	80	98	3 1/8"		5
05006466001	160287	# 2	100	105	4"		5

165 iSS PZ/S VDE Insulated screwdriver with reduced blade diameter for PlusMinus screws (Pozidriv/slotted)

- Reduced blade and handle diameter
- Allows screwdriving even in confined situations
- Low-lying screw and spring elements can be reached and actuated

165 iSS PZ/S VDE Insulated screwdriver with reduced blade diameter for PlusMinus screws (Pozidriv/slotted)



	EAN	+	mm	mm	mm		
Code	4013288						
05020132001	179418	# 1	80	81	3 1/8"		5
05020134001	179401	# 2	100	98	4"		5



167 i VDE Insulated screwdriver for TORX® screws



Code	EAN					
			mm	mm	"	
05006181001	108876	TX 5	80	81	3 1/8"	5
05006182001	108883	TX 6	80	81	3 1/8"	5
05006183001	108890	TX 7	80	81	3 1/8"	5
05006184001	108906	TX 8	80	81	3 1/8"	5
05006169001	036452	TX 9	80	81	3 1/8"	5
05006170001	036667	TX 10	80	81	3 1/8"	5
05006172001	036674	TX 15	80	98	3 1/8"	5
05006174001	036681	TX 20	80	98	3 1/8"	5
05006176001	036698	TX 25	100	105	4"	5
05006177001	036469	TX 27	100	105	4"	5
05006178001	036704	TX 30	100	105	4"	5
05006179001	036476	TX 40	150	112	6"	5

168 i VDE Insulated screwdriver for square socket head screws



Code	EAN						
			mm	mm	"		
05004780001	038777		# 1	80	98	3 1/8"	5
05004783001	105486		# 1	150	98	6"	5
05004781001	038784		# 2	100	105	4"	5
05004784001	105493		# 2	200	105	8"	5
05004782001	040909		# 3	150	112	6"	5

168 i SB VDE Insulated screwdriver for square socket head screws



Code	EAN			
	4013288			
05100024001	181534		168 i VDE 1x # 1x80	5
05100025001	181541		168 i VDE 1x # 2x100	5
05100026001	181558		168 i VDE 1x # 3x150	5

190 i VDE Insulated nutdriver



Code	EAN							
		mm	mm	mm	mm	mm	"	
05005300001	032485	5,5		125	98	11,0	5"	5
05005305001	032492	6,0		125	98	12,0	5"	5
05005310001	032508	7,0		125	105	14,0	5"	5
05005315001	032515	8,0		125	105	15,0	5"	5
05005320001	032522	9,0		125	105	16,0	5"	5
05005325001	032539	10,0		125	112	17,0	5"	5
05005330001	032546	11,0		125	112	19,0	5"	5
05005335001	032553	12,0		125	112	20,0	5"	5
05005340001	032560	13,0		125	112	21,0	5"	5

247 Single-pole phase tester



Code	EAN							
		mm	mm	mm	mm	"	"	
05005655001	002686	0,5	3,0	70	3,0	1/8"	2 3/4"	5

^{*)}Product not available in the USA and Canada.

247 SB Single-pole phase tester



Code	EAN			
	4013288			
05100100001	181664		247 1x 0.5x3.0x70	5

^{*)}Product not available in the USA and Canada.

Kraftform Big Pack 100 VDE

14-piece screwdriver set with individually tested, insulated screwdrivers as per IEC 60900. Individual testing at 10,000 volts so as to ensure safe working at the permitted voltage of 1,000 volts.

- Insulated blades for secure work at 1,000 volts
- Multi-component Kraftform handle for high working speeds and ergonomic screwdriving
- Take it easy tool finder: colour coding according to profile and size
- Hexagonal anti-roll feature against rolling away
- Lasertip tips for more secure fit in the screw head

Kraftform Big Pack 100 VDE

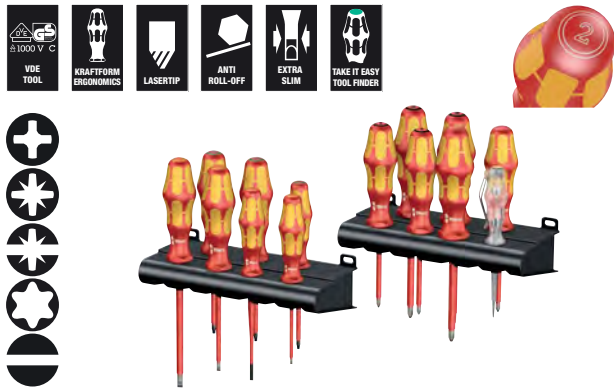

Code	EAN			
05105631001	163639			1
		+	162 i PH VDE 1x PH 1x80; 1x PH 2x100	
		+	165 i PZ VDE 1x PZ 1x80; 1x PZ 2x100	
		+	165 i PZ/S VDE 1x # 1x80; 1x # 2x100	
		+	167 i TORX® VDE 1x TX 10x80; 1x TX 15x80; 1x TX 20x80	
		●	160 iS 1x 0,6x3,5x100	
		●	160 i VDE 1x 0,4x2,5x80 ¹⁾ ; 1x 0,8x4,0x100; 1x 1,0x5,5x125	
		●	247 1x 0,5x3,0x70	
			Rack 2x 190,0x50,0	

¹⁾ without Lasertip

²⁾ Product not available in the USA and Canada.

Kraftform 2go 100

11 VDE-insulated, Kraftform screwdrivers; with Take it easy Toolfinder; in the Wera 2go 4 quiver; comes with an adjustable partition element for individual sectioning.

- Suitable for docking with the Wera 2go system

Kraftform 2go 100



Code	EAN			
05004310001	187826			1
			Wera 2go 4 1x 165,0x165,0x105,0	
		+	162 i PH VDE 1x PH 1x80; 1x PH 2x100	
		+	165 i PZ VDE 1x PZ 1x80; 1x PZ 2x100	
		+	167 i TORX® VDE 1x TX 10x80; 1x TX 15x80; 1x TX 20x80	
		●	160 i VDE 1x 0,4x2,5x80 ¹⁾ ; 1x 0,8x4,0x150; 1x 1,0x5,5x200	
		●	160 iS 1x 0,6x3,5x100	
			K120 1x 50,0x120,0	

¹⁾ without Lasertip

160 i/6 Rack Screwdriver set Kraftform Plus Series 100 + Rack

- Including useful rack for well-arranged storage of the screwdrivers

160 i/6 Rack Screwdriver set Kraftform Plus Series 100 + Rack

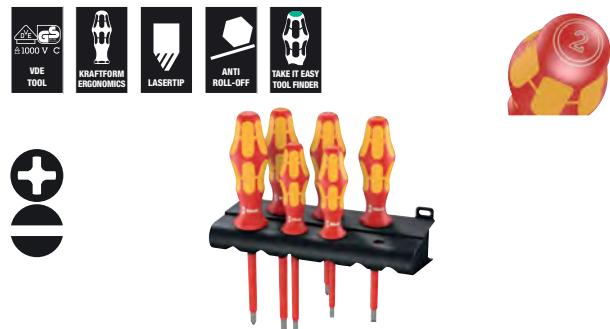

Code	EAN			
05006145001	027887			1
		+	162 i PH VDE 1x PH 1x80; 1x PH 2x100	
		●	160 i VDE 1x 0,4x2,5x80 ¹⁾ ; 1x 0,6x3,5x100 ¹⁾ ; 1x 0,8x4,0x100; 1x 1,0x5,5x125	

¹⁾ without Lasertip



160 i/7 Rack Screwdriver set Krafftform Plus Series 100, single-pole phase tester and rack

- Including useful rack for well-arranged storage of the screwdrivers

160 i/7 Rack Screwdriver set Krafftform Plus Series 100, single-pole phase tester and rack



Code	EAN		
05006147001	4013288 041708		1
		+	162 i PH VDE 1x PH 1x80; 1x PH 2x100
		-	160 i VDE 1x 0,4x2,5x80 ¹⁾ ; 1x 0,6x3,5x100 ¹⁾ ; 1x 0,8x4,0x100; 1x 1,0x5,5x125
		-	247 1x 0,5x3,0x70

¹⁾ without Lasertip

²⁾ Product not available in the USA and Canada.

160 i/165 i/7 Rack Screwdriver set Krafftform Plus Series 100, single-pole phase tester and rack

- Including useful rack for well-arranged storage of the screwdrivers

160 i/165 i/7 Rack Screwdriver set Krafftform Plus Series 100, single-pole phase tester and rack



Code	EAN		
05006148001	4013288 041715		1
		+	165 i PZ VDE 1x PZ 1x80; 1x PZ 2x100
		-	160 i VDE 1x 0,4x2,5x80 ¹⁾ ; 1x 0,6x3,5x100 ¹⁾ ; 1x 0,8x4,0x100; 1x 1,0x5,5x125
		-	247 1x 0,5x3,0x70

¹⁾ without Lasertip

²⁾ Product not available in the USA and Canada.

167 i/6 Screwdriver set Krafftform Plus Series 100

- Including useful rack for well-arranged storage of the screwdrivers

167 i/6 Screwdriver set Krafftform Plus Series 100



Code	EAN		
05133356001	4013288 160072		1
		+	167 i TORX® VDE 1x TX 8x80; 1x TX 9x80; 1x TX 10x80; 1x TX 15x80; 1x TX 20x80; 1x TX 25x100

160 iS/7 Rack Screwdriver set Krafftform Plus Series 100, single-pole phase tester and rack. With reduced blade diameter.

- Reduced shaft diameter
- Allows screwdriving even in confined situations
- Low-lying screw and spring elements can be reached and actuated
- Including useful rack for well-arranged storage of the screwdrivers

160 iS/7 Rack Screwdriver set Krafftform Plus Series 100, single-pole phase tester and rack. With reduced blade diameter



Code	EAN		
05006480001	4013288 160713		1
		+	162 iS 1x PH 1x80; 1x PH 2x100
		+	165 iS PZ/S 1x # 2x100
		-	160 iS 1x 0,6x3,5x100; 1x 0,8x4,0x100; 1x 1,0x5,5x125
		-	247 1x 0,5x3,0x70

²⁾ Product not available in the USA and Canada.

160 iSS/7 Screwdriver set Kraftform Plus Series 100. With reduced blade diameters and smaller handle diameters

- Kraftform screwdrivers with reduced blade diameter as well as partially with slim handle design
- Allows screwdriving even in confined situations
- Low-lying screw and spring elements can be reached and actuated
- Safe work at a voltage of 1,000 volts, individually tested

160 iSS/7 Screwdriver set Kraftform Plus Series 100. With reduced blade diameters and smaller handle diameters

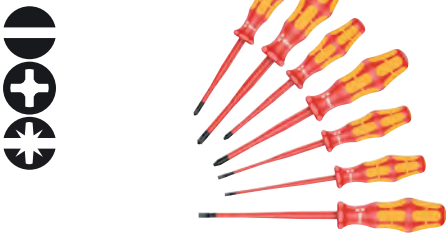
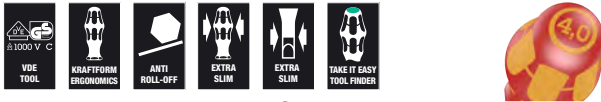

Code	EAN			
05135961001	178640			1
		⊖	160 iSS 1x 0,8x4,0x100	
		⊖	160 iS 1x 0,6x3,5x100; 1x 1,0x5,5x125	
		⊕	162 iSS 1x PH 1x80; 1x PH 2x100	
		⊕	165 iSS PZ/S 1x # 1x80; 1x # 2x100	

160 i/168 i/6 Rack Screwdriver set Kraftform Plus Series 100, and rack

- Including useful rack for well-arranged storage of the screwdrivers

160 i/168 i/6 Rack Screwdriver set Kraftform Plus Series 100, and rack



Code	EAN			
05347777001	122957			1
		⊕	162 i PH VDE 1x PH 1x80; 1x PH 2x100	
		⊖	160 i VDE 1x 0,6x3,5x100 ¹⁾ ; 1x 1,0x5,5x125	
		⊖	168 i VDE 1x # 1x80; 1x # 2x100	

¹⁾without Lasertip

160 i/162 i/167 i/9 Screwdriver set Kraftform Plus Series 100

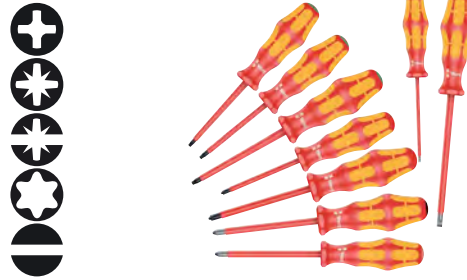

Code	EAN			
05133355001	160065			1
		⊕	162 i PH VDE 1x PH 2x100	
		⊕	165 i PZ VDE 1x PZ 2x100	
		⊕	165 i PZ/S VDE 1x # 1x80; 1x # 2x100	
		⊕	167 i TORX® VDE 1x TX 15x80; 1x TX 20x80; 1x TX 25x100	
		⊖	160 i VDE 1x 0,4x2,5x80 ¹⁾ ; 1x 1,0x5,5x125	

¹⁾without Lasertip

Kraftform 100 iS/7 set 1 Screwdriver set Kraftform Plus series 100. Partly with reduced blade diameter

- 7-piece VDE screwdriver set in compact, textile box with Wera 2go compatibility
- Insulated tools, blades partly with reduced diameter for safe working at up to 1,000 Volt

Kraftform 100 iS/7 set 1 Screwdriver set Kraftform Plus series 100. Partly with reduced blade diameter



Code	EAN			
05136013001	217615			1
		⊕	162 iS 1x PH 1x80; 1x PH 2x100	
		⊕	165 iS PZ/S 1x # 2x100	
		⊕	167 i TORX® VDE 1x TX 20x80; 1x TX 25x100	
		⊖	160 iS 1x 0,6x3,5x100; 1x 1,0x5,5x125	
			K240 1x 50,0x240,0	

Kraftform 100 iS/7 set 2 Screwdriver set Kraftform Plus series 100. Partly with reduced blade diameter

- 6-piece VDE screwdriver set in compact, textile box with Wera 2go compatibility
- Insulated tools, blades partly with reduced diameter for safe working at up to 1,000 Volt
- With Wera bottle opener

Kraftform 100 iS/7 set 2 Screwdriver set Kraftform Plus series 100. Partly with reduced blade diameter



Code	EAN			
05136022001	218155			1
		+	162 iS 1x PH 1x80; 1x PH 2x100	
		-	160 iS 1x 0,6x3,5x100; 1x 0,8x4,0x100; 1x 1,0x5,5x125	
		-	160 i VDE 1x 0,4x2,5x80 ¹⁾	
			Bottle opener 1x 145	
			K240 1x 50,0x240,0	

¹⁾without Lasertip

Kraftform 100 iS/7 set 3 Screwdriver set Kraftform Plus series 100. Partly with reduced blade diameter

- 6-piece VDE screwdriver set in compact, textile box with Wera 2go compatibility
- Insulated tools, blades partly with reduced diameter for safe working at up to 1,000 Volt
- With Wera bottle opener

Kraftform 100 iS/7 set 3 Screwdriver set Kraftform Plus series 100. Partly with reduced blade diameter



Code	EAN			
05136018001	217998			1
		+	162 iS 1x PH 1x80; 1x PH 2x100	
		-	160 iS 1x 0,8x4,0x100; 1x 1,0x5,5x125	
		○	168 i VDE 1x # 1x80; 1x # 2x100	
			Bottle opener 1x 145	
			K240 1x 50,0x240,0	

Kraftform 100 i/7 set 1 Screwdriver set Kraftform Plus series 100

7-piece VDE screwdriver set. Kraftform Plus handle for comfortable ergonomic screwdriving, which avoids blisters and calluses. Hard handle zones for high working speeds, while soft handle zones guarantee high torque transfer.

Take it easy tool finder with colour coding and size stamping - for easy and fast location of the required tool. The anti-roll protection avoids bits from annoying rolling away in the workplace.

- 7-piece VDE screwdriver set in compact, textile box with Wera 2go compatibility

Kraftform 100 i/7 set 1 Screwdriver set Kraftform Plus series 100



Code	EAN			
05136019001	4013288 218001			1
		⊕	165 i PZ VDE 1x PZ 1x80; 1x PZ 2x100	
		⊕	162 i PH/S VDE 1x # 2x100	
		⊖	160 i VDE 1x 0,4x2,5x80 ¹⁾ ; 1x 0,6x3,5x100 ¹⁾ ; 1x 0,8x4,0x100; 1x 1,0x5,5x125	
			K240 1x 50,0x240,0	

¹⁾without Lasertip

165 iS PZ/S # 1 + 2 Screwdriver set Kraftform Plus series 100. With reduced blade diameter

- Reduced shaft diameter: combination profile - Pozidriv / slotted
- Allows screwdriving even in confined situations
- Low-lying screw and spring elements can be reached and actuated



165 iS PZ/S # 1 + 2 Screwdriver set Kraftform Plus series 100. With reduced blade diameter



Code	EAN			
05006470001	4013288 214317			1
		⊕	165 iS PZ/S 1x # 1x80; 1x # 2x100	

Kraftform Kompakt VDE Stainless 17 extra slim 1

15 VDE stainless blades, most of which with reduced blade diameter, so that even low-lying screw and spring elements can be easily reached and operated.

Two 3817 VDE Kraftform bitholding screwdrivers for ergonomic screwdriving. Individually tested tools as per IEC 60900. Individually tested at 10,000 V for safe working at the approved voltage of 1,000 V.

Wera's stainless steel tools are vacuum ice tempered and therefore have the hardness and strength properties required for screw connections. Industrial use is possible without restrictions. The pouch is suitable for attachment to walls, shelves, workshop trolleys and the Wera 2go system thanks to the hook and loop fastener system on the back.

- Individually tested VDE Stainless blades, some of which with reduced blade diameter
- Two multi-component VDE-insulated Kraftform Stainless bitholding screwdrivers with anti-roll protection
- Individually tested tool as per IEC 60900 at 10,000V
- Blades made of stainless steel to prevent extraneous rust
- Vacuum ice-hardening provides the required hardness and strength
- Ergonomic Kraftform handles for fatigue-free work
- In robust folding bag with Wera 2go compatibility

Kraftform Kompakt VDE Stainless 17 extra slim 1



Code	EAN		
05059041001	4013288 220547		1
		● 3817 VDE Stainless 2x 9x98	
		⊕ Kraftform Kompakt VDE 3062 IS 1x PH 1x154; 1x PH 2x154	
		⊕ Kraftform Kompakt VDE 3065 iS PZ 1x PZ 1x154; 1x PZ 2x154	
		⊕ Kraftform Kompakt VDE 3065 iS PZ/S 1x # 1x154; 1x # 2x154	
		⊕ Kraftform Kompakt VDE 3067 i TORX® 1x TX 10x154	
		⊕ Kraftform Kompakt VDE 3067 iS TORX® 1x TX 15x154; 1x TX 20x154; 1x TX 25x154	
		● Kraftform Kompakt VDE 3060 i 1x 0,4x2,5x154; 1x 1,2x6,5x154	
		● Kraftform Kompakt VDE 3060 iS 1x 0,6x3,5x154; 1x 0,8x4,0x154; 1x 1,0x5,5x154	
		Hook and Loop Fastener Strip 70 1x 50,0x70,0	

Kraftform Kompakt VDE Stainless 8 extra slim 1

7 VDE stainless blades, some of which with reduced blade diameter, so that even low-lying screw and spring elements can be easily reached and operated.

One 3817 VDE Kraftform bitholding screwdriver for ergonomic screwdriving. In a robust pouch. Individually tested tools as per IEC 60900. Individually tested at 10,000 V for safe working at the approved voltage of 1,000 V. Wera's stainless steel tools are vacuum ice tempered and therefore have the hardness and strength properties required for screw connections.

Industrial use is possible without restrictions. The pouch is suitable for attachment to walls, shelves, workshop trolleys and the Wera 2go system thanks to the hook and loop fastener system on the back.

Kraftform Kompakt VDE Stainless 8 extra slim 1



Code	EAN		
05059040001	220554		1
		3817 VDE Stainless 1x 9x98	
		Kraftform Kompakt VDE 3067 i TORX® 1x TX 8x154; 1x TX 9x154; 1x TX 10x154; 1x TX 30x154	
		Kraftform Kompakt VDE 3067 iS TORX® 1x TX 15x154; 1x TX 20x154; 1x TX 25x154	
		Hook and Loop Fastener Strip 70 1x 50,0x70,0	

3817 VDE Kraftform Stainless blade-holding handle

Premium VDE bitholding screwdriver solely for Wera VDE stainless blades. The handle/blade system allows for lightning-fast change of the required blade and thus a wide range of applications.

Kraftform Plus handle for comfortable ergonomic screwdriving, which avoids blisters and calluses. Hard handle zones for high working speeds, while soft handle zones guarantee a high torque transfer.

- Kraftform Kompakt VDE Stainless bitholding handle
- Smooth hard zones for high speed turning, soft grip zones for high torque transfer



3817 VDE Kraftform Stainless blade-holding handle



	EAN						
Code	4013288	mm	mm				
05003991001	220189	9	98				1

Kraftform Kompakt VDE 3060 i SB, stainless

VDE stainless blade for the Kraftform Kompakt handle/blade system for lightning-fast blade changes without special tools. Individually tested tools as per IEC 60900. Individually tested at 10,000 V for safe working at the approved voltage of 1,000 V.

Wera's stainless steel tools are vacuum ice hardened and therefore have the hardness and strength properties required for screw connections. Industrial use is possible without restrictions.

- Kraftform Kompakt VDE interchangeable blades for slotted screws
- Insulated, individually tested as per IEC 60900
- Blades made of stainless steel to prevent extraneous rust
- Vacuum ice-hardening provides the required hardness and strength
- 9 mm hex drive with with entry chamfer

Kraftform Kompakt VDE 3060 i SB, stainless

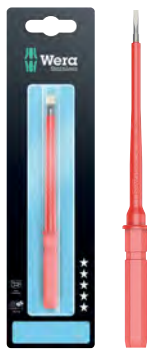

Code	EAN			
05033600001	220356	⊖	Kraftform Kompakt VDE 3060 i 1x 0.4x2.5x154	5
05033601001	220363	⊖	Kraftform Kompakt VDE 3060 i 1x 1.2x6.5x154	5

Kraftform Kompakt VDE 3060 iS SB, stainless

- Reduced shaft diameter and integrated insulation protection
- This means that low-lying screws and spring elements can be accessed and actuated

Kraftform Kompakt VDE 3060 iS SB, stainless



Code	EAN			
05033606001	220370	⊖	Kraftform Kompakt VDE 3060 iS 1x 0.6x3.5x154	5
05033607001	220387	⊖	Kraftform Kompakt VDE 3060 iS 1x 0.8x4.0x154	5
05033608001	220394	⊖	Kraftform Kompakt VDE 3060 iS 1x 1.0x5.5x154	5

Kraftform Kompakt VDE 3062 iS SB, stainless

- Reduced shaft diameter and integrated insulation protection
- In this way, low-lying PH screws can be accessed and actuated

Kraftform Kompakt VDE 3062 iS SB, stainless



Code	EAN			
05033613001	220400	⊕	Kraftform Kompakt VDE 3062 iS 1x PH 1x154	5
05033614001	220417	⊕	Kraftform Kompakt VDE 3062 iS 1x PH 2x154	5

Kraftform Kompakt VDE 3065 iS PZ SB, stainless

- Reduced shaft diameter and integrated insulation protection
- In this way, low-lying PZ screws can be accessed and actuated

Kraftform Kompakt VDE 3065 iS PZ SB, stainless



Code	EAN		
	4013288		
05033655001	220424		Kraftform Kompakt VDE 3065 iS PZ 1x PZ 1x154 5
05033656001	220431		Kraftform Kompakt VDE 3065 iS PZ 1x PZ 2x154 5

Kraftform Kompakt VDE 3065 iS PZ/S, stainless

- Reduced shaft diameter and integrated insulation protection
- In this way, low-lying PlusMinus screws can be accessed and actuated

Kraftform Kompakt VDE 3065 iS PZ/S SB, stainless



Code	EAN		
	4013288		
05033647001	220448		Kraftform Kompakt VDE 3065 iS PZ/S 1x # 1x154 5
05033648001	220455		Kraftform Kompakt VDE 3065 iS PZ/S 1x # 2x154 5

Kraftform Kompakt VDE 3067 i TORX®, stainless

- Kraftform Kompakt VDE interchangeable blade for TORX® screws

Kraftform Kompakt VDE 3067 i TORX® SB, stainless



Code	EAN		
	4013288		
05033629001	220462		Kraftform Kompakt VDE 3067 i TORX® 1x TX 8x154 5
05033630001	220479		Kraftform Kompakt VDE 3067 i TORX® 1x TX 9x154 5
05033631001	220486		Kraftform Kompakt VDE 3067 i TORX® 1x TX 10x154 5
05033636001	220493		Kraftform Kompakt VDE 3067 i TORX® 1x TX 30x154 5

Kraftform Kompakt VDE 3067 iS TORX® SB, stainless

- Reduced shaft diameter and integrated insulation protection
- In this way, low-lying TORX® screws can be accessed and actuated

Kraftform Kompakt VDE 3067 iS TORX® SB, stainless



Code	EAN		
	4013288		
05033637001	220509		Kraftform Kompakt VDE 3067 iS TORX® 1x TX 15x154 5
05033638001	220516		Kraftform Kompakt VDE 3067 iS TORX® 1x TX 20x154 5
05033639001	220523		Kraftform Kompakt VDE 3067 iS TORX® 1x TX 25x154 5



Kraftform Kompakt & VDE - every size always available

Kraftform Kompakt VDE 16 Torque 1,2-3,0 Nm extra slim 1

16-piece torque VDE interchangeable blade set. Includes 14 blades (11 of which with a reduced diameter) with integrated insulation protection.

Torque VDE holder with adjustable torque from 1.2-3.0 Nm and VDE holder 817 VDE. Kraftform Plus handle: hard gripping zones for high working speeds whereas soft zones ensure high torque transfer.

- Kraftform Kompakt VDE torque screwdriver set with adjustable torque
- Adjustable Kraftform VDE torque holder exclusively for Wera VDE interchangeable blades
- VDE interchangeable blades 154 mm long
- In robust pouch
- 16-piece

Kraftform Kompakt VDE 16 Torque 1.2-3.0 Nm extra slim 1



Code	EAN		
05135906001	188335		1
		● 7400 VDE 1x 7441 VDE, 1,2-3,0 Nm	
		● 817 VDE 1x 9x102	
		⊕ KK 62 iS 1x PH 1x154; 1x PH 2x154	
		⊕ KK 65 iS PZ 1x PZ 1x154; 1x PZ 2x154	
		⊕ KK 65 iS PZ/S 1x # 1x154; 1x # 2x154	
		⊗ KK 67 i TORX® 1x TX 10x154	
		⊗ KK 67 iS TORX® 1x TX 15x154; 1x TX 20x154; 1x TX 25x154	
		● KK 60 i 1x 0,4x2,5x154	
		● KK 60 iS 1x 0,6x3,5x154; 1x 0,8x4,0x154; 1x 1,0x5,5x154	

Kraftform Kompakt VDE 15 Torque 1.2-3.0 Nm extra slim 1

15-piece torque VDE interchangeable blade set. Includes 14 blades (12 of which with a reduced diameter) with integrated insulation protection. Torque VDE holder with adjustable torque from 1.2-3.0 Nm. Kraftform Plus handle: hard gripping zones for high working speeds whereas soft zones ensure high torque transfer.

Kraftform Kompakt VDE 15 Torque 1.2-3.0 Nm extra slim 1



Code	EAN		
05059291001	168375		1
		● 7400 VDE 1x 7441 VDE, 1,2-3,0 Nm	
		⊕ KK 62 iS 1x PH 1x154; 1x PH 2x154	
		⊕ KK 65 iS PZ 1x PZ 1x154; 1x PZ 2x154	
		⊕ KK 65 iS PZ/S 1x # 1x154; 1x # 2x154	
		⊗ KK 67 i TORX® 1x TX 10x154	
		⊗ KK 67 iS TORX® 1x TX 15x154; 1x TX 20x154; 1x TX 25x154	
		● KK 60 i 1x 0,4x2,5x154	
		● KK 60 iS 1x 0,6x3,5x154; 1x 0,8x4,0x154; 1x 1,0x5,5x154	

Kraftform Kompakt VDE 18 Universal 1

16 VDE interchangeable blades with 817 VDE Kraftform handle in a robust belt pouch. Individually tested tools as per IEC 60900.

Individual test at 10,000 volts for secure work at the permissible voltage of 1,000 volts.

Kraftform Kompakt VDE 18 Universal 1



Code	EAN		
05003471001	106599		1
		● 817 VDE 1x 9x102	
		⊕ KK 62 i 1x PH 1x154; 1x PH 2x154	
		⊕ KK 62 i PH/S 1x # 1x154; 1x # 2x154	
		⊕ KK 65 i PZ 1x PZ 1x154; 1x PZ 2x154	
		⊕ KK 65 i PZ/S 1x # 1x154; 1x # 2x154	
		● KK 60 i 1x 0,4x2,5x154; 1x 0,6x3,5x154; 1x 0,8x4,0x154; 1x 1,0x5,5x154	
		■ KK 96 VK 6,3 1x 6,3x89	
		■ KK 97 VK 8,1 1x 8,1x89	
		▲ KK 98 DK 1x 89	
		● KK 99 FL 1x 89	
		● 247 1x 0,5x3,0x70	

™Product not available in the USA and Canada.

Kraftform Kompakt VDE 18 Imperial 1



Code	EAN		
05347108001	182401		1
		● 817 VDE 2x 9x102	
		⊕ KK 62 i 1x PH 1x154; 1x PH 2x154	
		⊕ KK 62 i PH/S 1x # 1x154; 1x # 2x154	
		⊕ KK 65 i PZ/S 1x # 1x154; 1x # 2x154	
		● KK 60 i 1x 0,4x2,5x154; 1x 0,6x3,5x154; 1x 0,8x4,0x154; 1x 1,0x5,5x154	
		□ KK 68 i 1x # 1x154; 1x # 2x154	
		■ KK 96 VK 6,3 1x 6,3x89	
		■ KK 97 VK 8,1 1x 8,1x89	
		▲ KK 98 DK 1x 89	
		● KK 99 FL 1x 89	

Kraftform Kompakt VDE 18 Universal 2



Code	EAN		
05347107001	4013288 182395		1
		● 817 VDE 2x 9x102	
		+ KK 62 i 1x PH 1x154; 1x PH 2x154	
		+ KK 62 i PH/S 1x # 1x154; 1x # 2x154	
		● KK 60 i 1x 0,4x2,5x154; 1x 0,6x3,5x154; 1x 0,8x4,0x154; 1x 1,0x5,5x154	
		+ KK 65 i PZ 1x PZ 1x154; 1x PZ 2x154	
		+ KK 65 i PZ/S 1x # 1x154; 1x # 2x154	
		■ KK 96 VK 6,3 1x 6,3x89	
		■ KK 97 VK 8,1 1x 8,1x89	
		▲ KK 98 DK 1x 89	
		● KK 99 FL 1x 89	

Kraftform Kompakt VDE 17 extra slim 1

- Individually tested VDE interchangeable blades with reduced blade diameters
- 2 multi-component, ergonomic Kraftform VDE hand-holders with anti-roll protection
- In a robust textile box
- Multifunctional pliers for electrical installation: cable cutting, stripping, gripping, bending, deburring, crimping of wire end ferrules
- Pliers including cable shears with precision cutting edges (inductively hardened) for Cu and Al cables up to 5 x 2.5mm² / Ø 15 mm

Kraftform Kompakt VDE 17 extra slim 1



Code	EAN		
05136027001	4013288 208798		1
		● 817 VDE 2x 9x102	
		+ KK 62 iS 1x PH 1x154; 1x PH 2x154	
		+ KK 65 iS PZ 1x PZ 1x154; 1x PZ 2x154	
		+ KK 65 iS PZ/S 1x # 1x154; 1x # 2x154	
		● KK 67 i TORX® 1x TX 10x154	
		● KK 67 iS TORX® 1x TX 15x154; 1x TX 20x154; 1x TX 25x154	
		● KK 60 i 1x 0,4x2,5x154	
		● KK 60 iS 1x 0,6x3,5x154; 1x 0,8x4,0x154; 1x 1,0x5,5x154	
		KNIPEX® 13 96 200	
		K70 1x 50,0x70,0	

Kraftform Kompakt VDE 17 Universal 1

- 2 multi-component, ergonomic Kraftform VDE hand-holders with anti-roll protection

Kraftform Kompakt VDE 17 Universal 1



Code	EAN		
05059030001	173508		1
		817 VDE 2x 9x102	
		KK 62 i 1x PH 1x154; 1x PH 2x154	
		KK 65 i PZ 1x PZ 1x154; 1x PZ 2x154	
		KK 65 i PZ/S 1x # 1x154; 1x # 2x154	
		KK 67 i TORX® 1x TX 10x154; 1x TX 15x154; 1x TX 20x154; 1x TX 25x154	
		KK 60 i 1x 0,4x2,5x154; 1x 0,8x4,0x154; 1x 1,0x5,5x154; 1x 1,2x6,5x154	
		KK 60 iS 1x 0,6x3,5x154	

Kraftform Kompakt VDE 16 extra slim 1

- VDE interchangeable blade with reduced shaft diameter
- Allows screwdriving even in confined situations
- Low-lying screw and spring elements can be reached and actuated

Kraftform Kompakt VDE 16 extra slim 1



Code	EAN		
05003484001	164056		1
		817 VDE 1x 9x102	
		KK 62 iS 1x PH 1x154; 1x PH 2x154	
		KK 65 iS PZ 1x PZ 1x154; 1x PZ 2x154	
		KK 65 iS PZ/S 1x # 1x154; 1x # 2x154	
		KK 67 i TORX® 1x TX 10x154	
		KK 67 iS TORX® 1x TX 15x154; 1x TX 20x154; 1x TX 25x154	
		KK 60 i 1x 0,4x2,5x154	
		KK 60 iS 1x 0,6x3,5x154; 1x 0,8x4,0x154; 1x 1,0x5,5x154	
		247 1x 0,5x3,0x70	

*Product not available in the USA and Canada.



Kraftform Kompakt VDE 16 Universal 1



Code	EAN		
05003474001	4013288 144010		1
		● 817 VDE 1x 9x102	
		⊕ KK 62 i 1x PH 1x154; 1x PH 2x154	
		⊕ KK 65 i PZ 1x PZ 1x154; 1x PZ 2x154	
		⊕ KK 65 i PZ/S 1x # 1x154; 1x # 2x154	
		⊕ KK 67 i TORX® 1x TX 10x154; 1x TX 15x154; 1x TX 20x154; 1x TX 25x154	
		● KK 60 i 1x 0,4x2,5x154; 1x 0,6x3,5x154; 1x 0,8x4,0x154; 1x 1,0x5,5x154	
		● 247 1x 0,5x3,0x70	

Product not available in the USA and Canada.

Kraftform Kompakt VDE 7 extra slim 1

- Individually tested VDE interchangeable blades with reduced blade diameters
- In robust folding bag with Wera 2go compatibility

Kraftform Kompakt VDE 7 extra slim 1



Code	EAN		
05003475001	4013288 217691		1
		● 817 VDE 1x 9x102	
		⊕ KK 62 iS 1x PH 1x154; 1x PH 2x154	
		⊕ KK 65 iS PZ/S 1x # 2x154	
		⊕ KK 67 iS TORX® 1x TX 15x154; 1x TX 20x154	
		● KK 60 iS 1x 0,6x3,5x154	
		K70 1x 50,0x70,0	

Kraftform Kompakt VDE 7 Universal 1

6 VDE interchangeable blades with 817 VDE Kraftform handle in a robust belt pouch. Individually tested tools as per IEC 60900.

Individual test at 10,000 volts for secure work at the permissible voltage of 1,000 volts.

Kraftform Kompakt VDE 7 Universal 1



Code	EAN		
05003470001	4013288 106582		1
		● 817 VDE 1x 9x102	
		⊕ KK 62 i 1x PH 1x154; 1x PH 2x154	
		● KK 60 i 1x 0,4x2,5x154; 1x 0,6x3,5x154; 1x 0,8x4,0x154; 1x 1,0x5,5x154	

Kraftform Kompakt VDE 7 Imperial 1



Code	EAN		
05003473001	4013288 106612		1
		● 817 VDE 1x 9x102	
		⊕ KK 62 i 1x PH 1x154; 1x PH 2x154	
		● KK 60 i 1x 0,6x3,5x154; 1x 1,0x5,5x154	
		○ KK 68 i 1x # 1x154; 1x # 2x154	

Kraftform Kompakt VDE 7 Universal 2



	Code	EAN							
	05003472001	4013288	106605						1
				●	817 VDE 1x 9x102				
				+	KK 65 i PZ 1x PZ 1x154; 1x PZ 2x154				
				●	KK 60 i 1x 0,4x2,5x154; 1x 0,6x3,5x154; 1x 0,8x4,0x154; 1x 1,0x5,5x154				

Series 7400 VDE Kraftform adjustable torque handle (0.3-3.5 Nm)

- Adjustable Kraftform VDE torque holder
- Adjustable torque from 0.3-1.2
- Distinct audible and perceivable excess load signal when the pre-set torque value is reached
- Suitable for Kraftform Kompakt VDE blades
- Rapid exchange of the interchangeable blades

Series 7400 VDE Kraftform adjustable torque handle (0.3-3.5 Nm)



	Code	EAN	Art.No.								
	05074752001	179111	7440 VDE	9	0,3-1,2	0,05	192	7 9/16"			1
	05074750001	168535	7441 VDE	9	1,2-3,0	0,10	192	7 9/16"			1
	05074757001	184412	7444 VDE	9	1,7-3,5	0,10	192	7 9/16"			1

817 VDE Kraftform blade-holding handle SB

- Kraftform Kompakt VDE Kraftform handle
- Exclusively for Wera VDE interchangeable blades
- Smooth hard zones for high speed turning, soft grip zones for high torque transfer
- Hexagonal anti-roll feature against rolling away

817 VDE Kraftform blade-holding handle SB



	Code	EAN									
	05003990001	4013288	9	102							1

Kraftform Kompakt Turbo i 1

Many users would like to be able to carry out screwdriving processes faster without compromise. With a screwdriver that is precise, allows powerful screwdriving, and is much faster than a conventional screwdriver.

A part-time universal gear is the solution: Integrated in the screwdriver handle, it quadruples the working speed with smooth couplings - purely mechanically. One hand holds the front part of the handle, the other hand turns the rear part of the handle.

The turbo function can be switched on or off at the push of a button. Turning it off is recommended for tightening and loosening with high torque as well as for fine adjustments.

Robust, maintenance-free gear made of steel with a maximum torque of 14Nm when the turbo function is deactivated.

With the Wera VDE interchangeable blades individually tested as per IEC 60900, the VDE version of the Kraftform Turbo hand holder 827 T i guarantees fast and safe working even in live environments (up to 1.000 volts).

- 4 times the screwdriving speed thanks to the turbo function (purely mechanical - without battery)
- Activate and deactivate the turbo function by a simple push of a button
- Turbo function especially for smooth couplings
- Can be used without the turbo function like a normal screwdriver, for couplings with steadily increasing torque
- Robust, maintenance-free gear made of steel



Kraftform Kompakt Turbo i 1



	Code	EAN								
	05057484001	4013288	214638							1
				●	827 T i Kraftform Turbo 1x 9x125					
				●	817 VDE 1x 9x102					
				+	KK 62 iS 1x PH 1x154; 1x PH 2x154					
				+	KK 65 i PZ 1x PZ 1x154; 1x PZ 2x154					
				+	KK 65 iS PZ/S 1x # 1x154; 1x # 2x154					
				●	KK 67 i TORX® 1x TX 10x154					
				●	KK 67 iS TORX® 1x TX 15x154; 1x TX 20x154; 1x TX 25x154					
				●	KK 60 i 1x 0,4x2,5x154					
				●	KK 60 iS 1x 0,6x3,5x154; 1x 0,8x4,0x154; 1x 1,0x5,5x154					

Kraftform Kompakt Turbo i Imperial 1



Code	EAN						
05057485001	4013288 214669						1
			827 T i Kraftform Turbo 1x 9x125				
			817 VDE 1x 9x102				
			KK 62 iS 1x PH 1x154; 1x PH 2x154				
			KK 62 i PH/S 1x # 1x154; 1x # 2x154				
			KK 67 i TORX® 1x TX 10x154				
			KK 67 iS TORX® 1x TX 15x154; 1x TX 20x154; 1x TX 25x154				
			KK 68 iS 1x # 1x154; 1x # 2x154				
			KK 60 i 1x 0,4x2,5x154				
			KK 60 iS 1x 0,6x3,5x154; 1x 0,8x4,0x154; 1x 1,0x5,5x154				

827 T i Kraftform Turbo hand holder

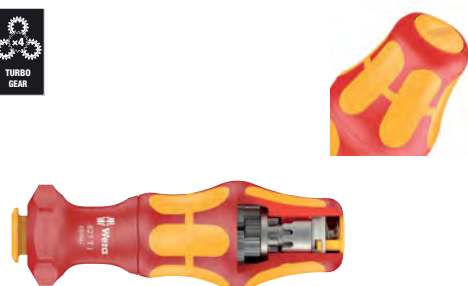

Code	EAN						
05057481001 ¹⁾	4013288 214607	mm	mm				1
		9	125				

Kraftform Kompakt VDE 60 i

VDE blades for Kraftform Kompakt handle/interchangeable blade system for rapid exchange of the blades without any special tools. Individually tested as per IEC 60900.

Individual testing at 10,000 volts so as to ensure safe working at the permitted voltage of 1,000 volts.

Kraftform Kompakt VDE 60 i



Code	EAN							
	4013288	mm	mm	mm				
05003400001	104052	0,4	2,5	154	3/32"	6 1/16"		5
05003401001	104069	0,5	3,0	154	1/8"	6 1/16"		5
05003402001	104076	0,6	3,5	154	9/64"	6 1/16"		5
05003403001	104083	0,8	4,0	154	5/32"	6 1/16"		5
05003404001	104090	1,0	5,5	154	7/32"	6 1/16"		5
05003405001	104106	1,2	6,5	154	1/4"	6 1/16"		5

Kraftform Kompakt VDE 60 i SB



Code	EAN						
	4013288						
05004400001	220790		KK 60 i 1x 0.4x2.5x154				5
05004401001	220806		KK 60 i 1x 0.5x3.0x154				5
05004402001	220813		KK 60 i 1x 0.6x3.5x154				5
05004403001	220820		KK 60 i 1x 0.8x4.0x154				5
05004404001	220837		KK 60 i 1x 1.0x5.5x154				5
05004405001	220844		KK 60 i 1x 1.2x6.5x154				5

Kraftform Kompakt VDE 60 iS

- Reduced shaft diameter and integrated insulation protection
- Allows screwdriving even in confined situations
- Low-lying screw and spring elements can be reached and actuated

Kraftform Kompakt VDE 60 iS



	EAN						
Code	4013288	mm	mm	mm			
05003406001	163882	0,6	3,5	154	9/64"	6 1/16"	5
05003407001	163899	0,8	4,0	154	5/32"	6 1/16"	5
05003408001	163905	1,0	5,5	154	7/32"	6 1/16"	5

Kraftform Kompakt VDE 60 iS SB



	EAN			
Code	4013288			
05004406001	220851		KK 60 iS 1x 0.6x3.5x154	5
05004407001	220868		KK 60 iS 1x 0.8x4.0x154	5
05004408001	220875		KK 60 iS 1x 1.0x5.5x154	5

Kraftform Kompakt VDE 62 i



	EAN							
Code	4013288		mm					
05003410001	104113	PH 0	154	6 1/16"				5
05003411001	104120	PH 1	154	6 1/16"				5
05003412001	104137	PH 2	154	6 1/16"				5

Kraftform Kompakt VDE 62 iS

- Reduced shaft diameter and integrated insulation protection
- Allows screwdriving even in confined situations
- Low-lying screw and spring elements can be reached and actuated

Kraftform Kompakt VDE 62 iS



	EAN							
Code	4013288		mm					
05003413001	163912	PH 1	154	6 1/16"				5
05003414001	163929	PH 2	154	6 1/16"				5

Kraftform Kompakt VDE 62 iS SB



	EAN			
Code	4013288			
05004413001	220882		KK 62 iS 1x PH 1x154	5
05004414001	220899		KK 62 iS 1x PH 2x154	5

Kraftform Kompakt VDE 65 i



	EAN							
Code	4013288		mm					
05003450001	104144	PZ 0	154	6 1/16"				5
05003451001	104151	PZ 1	154	6 1/16"				5
05003452001	104168	PZ 2	154	6 1/16"				5



Kraftform Kompakt VDE 65 iS

- Reduced shaft diameter and integrated insulation protection
- Allows screwdriving even in confined situations
- Low-lying screw and spring elements can be reached and actuated

Kraftform Kompakt VDE 65 iS



	EAN					
Code	4013288		mm			
05003455001	163950	PZ 1	154	6 1/16"		5
05003456001	164032	PZ 2	154	6 1/16"		5

Kraftform Kompakt VDE 65 iS PZ SB



Code	EAN			
	4013288			
05004455001	220905		KK 65 iS PZ 1x PZ 1x154	5
05004456001	220912		KK 65 iS PZ 1x PZ 2x154	5

Kraftform Kompakt VDE 62 i PH/S

- Kraftform Kompakt VDE interchangeable blade for PlusMinus screws slotted / Phillips
- Particularly for jobs on terminal blocks, fuse boxes, switches and relays

Kraftform Kompakt VDE 62 i PH/S



	EAN					
Code	4013288		mm			
05003440001	104311	# 1	154	6 1/16"		5
05003441001	104328	# 2	154	6 1/16"		5

Kraftform Kompakt VDE 62 iS PH/S

- Kraftform Kompakt VDE interchangeable blade for PlusMinus screws slotted / Phillips
- Reduced shaft diameter and integrated insulation protection
- Allows screwdriving even in confined situations
- Low-lying screw and spring elements can be reached and actuated

Kraftform Kompakt VDE 62 iS PH/S



	EAN					
Code	4013288		mm			
05003442001	163936	# 1	154	6 1/16"		5
05003443001	163943	# 2	154	6 1/16"		5

Kraftform Kompakt VDE 65 i PZ/S

- Combination profile - Pozidriv / slotted
- Particularly for jobs on terminal blocks, fuse boxes, switches and relays

Kraftform Kompakt VDE 65 i PZ/S



	EAN					
Code	4013288		mm			
05003445001	104335	# 1	154	6 1/16"		5
05003446001	104342	# 2	154	6 1/16"		5

Kraftform Kompakt VDE 65 iS PZ/S

- Combination profile - Pozidriv/slotted
- Reduced shaft diameter and integrated insulation protection
- Allows screwdriving even in confined situations
- Low-lying screw and spring elements can be reached and actuated

Kraftform Kompakt VDE 65 iS PZ/S



	EAN					
Code	4013288		mm			
05003447001	164018	# 1	154	6 1/16"		5
05003448001	164025	# 2	154	6 1/16"		5

Kraftform Kompakt VDE 65 iS PZ/SB



Code	EAN			
	4013288			
05004447001	220936		KK 65 iS PZ/S 1x # 1x154	5
05004448001	220943		KK 65 iS PZ/S 1x # 2x154	5

Kraftform Kompakt VDE 67 i TORX®



Code	EAN			mm					
	4013288								
05003429001	196491	TX 8	154	6 1/16"					5
05003430001	104243	TX 9	154	6 1/16"					5
05003431001	104250	TX 10	154	6 1/16"					5
05003432001	104267	TX 15	154	6 1/16"					5
05003433001	104274	TX 20	154	6 1/16"					5
05003434001	104281	TX 25	154	6 1/16"					5
05003435001	104298	TX 27	154	6 1/16"					5
05003436001	104304	TX 30	154	6 1/16"					5

Kraftform Kompakt VDE 67 i TORX® SB



Code	EAN								
	4013288								
05004431001	220950		KK 67 i TORX® 1x TX 10x154						5
05004432001	220967		KK 67 i TORX® 1x TX 15x154						5
05004433001	220974		KK 67 i TORX® 1x TX 20x154						5
05004434001	220981		KK 67 i TORX® 1x TX 25x154						5
05004436001	220998		KK 67 i TORX® 1x TX 30x154						5

Kraftform Kompakt VDE 67 iS TORX®

- Reduced shaft diameter and integrated insulation protection
- Allows screwdriving even in confined situations
- Low-lying screw and spring elements can be reached and actuated



Kraftform Kompakt VDE 67 iS TORX®



Code	EAN			mm					
	4013288								
05003437001	163981	TX 15	154	6 1/16"					5
05003438001	163998	TX 20	154	6 1/16"					5
05003439001	164001	TX 25	154	6 1/16"					5

Kraftform Kompakt VDE 68 i



Code	EAN			mm					
	4013288								
05003415001	104175	# 1	154	6 1/16"					5
05003416001	104182	# 2	154	6 1/16"					5

Kraftform Kompakt VDE 68 iS

- Reduced shaft diameter and integrated insulation protection
- Allows screwdriving even in confined situations
- Low-lying screw and spring elements can be reached and actuated

Kraftform Kompakt VDE 68 iS



Code	EAN			mm					
	4013288								
05003417001	163967	# 1	154	6 1/16"					5
05003418001	163974	# 2	154	6 1/16"					5

Kraftform Kompakt VDE 64 i



	EAN					
Code	4013288	mm	mm			
05003420001	104199	2,5	154	6 1/16"		5
05003421001	104205	3,0	154	6 1/16"		5
05003422001	104212	4,0	154	6 1/16"		5
05003423001	104229	5,0	154	6 1/16"		5
05003424001	104236	6,0	154	6 1/16"		5

Kraftform Kompakt VDE 64 i SB



Code	EAN				
	4013288				
05004420001	221001		KK 64 i 1x 2.5x154		5
05004421001	221018		KK 64 i 1x 3.0x154		5
05004422001	221025		KK 64 i 1x 4.0x154		5
05004423001	221032		KK 64 i 1x 5.0x154		5
05004424001	221049		KK 64 i 1x 6.0x154		5

Kraftform Kompakt 96 VK 6,3

Glass-fibre reinforced switch cabinet key. Blade for Kraftform Kompakt handle/interchangeable blade system for rapid exchange of the blade without needing any special tools - square socket.

Kraftform Kompakt 96 VK 6,3



	EAN					
Code	4013288	mm	mm			
05003460001	105349	6,3	89	3 9/16"		5

Kraftform Kompakt 97 VK 8,1

- Kraftform Kompakt switch cabinet key 8.1 mm

Kraftform Kompakt 97 VK 8,1



	EAN					
Code	4013288	mm	mm			
05003461001	105370	8,1	89	3 9/16"		5

Kraftform Kompakt 98 DK



	EAN					
Code	4013288		mm			
05003462001	105356		89	3 9/16"		5

Kraftform Kompakt 99 FL



	EAN					
Code	4013288		mm			
05003463001	105363		89	3 9/16"		5

Kraftform – Series 1000 VDE

Premium Kraftform VDE screwdriver. Multi-component Kraftform handle for fast and gentle work. The Wera Black Point tip and a sophisticated hardening process guarantee a long usability for the tip, increased corrosion protection and exact fitting accuracy.

Individually tested at 10,000 V for safe working at the approved voltage of 1,000 V. The hexagon anti-roll protection avoids bits from rolling away annoyingly at the workplace. Handles marked to find and sort the tools easily.

- Insulated screwdriver for safe working up to 1,000 volts
- Individually tested
- Multi-component Kraftform handle for fast and low-fatigue working
- Handle markings simplify finding and sorting of tools
- The Wera Black Point tip offers an exact fit and optimum corrosion protection

1060 i VDE-insulated Kraftform slotted screwdriver



	EAN							
Code	4013288	mm	mm	mm	mm			
05051580001	222268	0,4	2,5	80	81	3/32"	3 1/8"	10
05051582001	222275	0,6	3,5	100	81	9/64"	4"	10
05051583001	222282	0,8	4,0	100	98	5/32"	4"	10
05051587001	222299	1,0	5,5	125	98	7/32"	5"	10

1062 i PH VDE-insulated Kraftform Phillips-head screwdriver



	EAN						
Code	4013288		mm	mm			
05051601001	222220	PH 1	80	98	3 1/8"		5
05051603001	222237	PH 2	100	105	4"		5

1065 i PZ VDE-insulated Kraftform Phillips-head screwdriver



	EAN						
Code	4013288		mm	mm			
05051611001	222244	PZ 1	80	98	3 1/8"		5
05051613001	222251	PZ 2	100	105	4"		5

1060 i/1062 i/6 Kraftform VDE screwdriver set

Premium Kraftform VDE screwdriver set. Multi-component Kraftform handle for fast and gentle work. The Wera Black Point tip and a sophisticated hardening process guarantee a long usability for the tip, increased corrosion protection and exact fitting accuracy.

Individually tested at 10,000 V for safe working at the approved voltage of 1,000 V. The hexagon anti-roll protection avoids bits from rolling away annoyingly at the workplace. Handles marked to find and sort the tools easily.

1060 i/1062 i/6 Kraftform VDE screwdriver set



	EAN			
Code	4013288			
05051575001	222381			1
			1062 i PH VDE 1x PH 1x80; 1x PH 2x100	
			1060 i VDE 1x 0,4x2,5x80; 1x 0,6x3,5x100; 1x 0,8x4,0x100; 1x 1,0x5,5x125	

1060 i/1065 i/6 Kraftform VDE screwdriver set



Code		EAN		1
05051576001		4013288 222374		
		1065 i PZ VDE 1x PZ 1x80; 1x PZ 2x100		
		1060 i VDE 1x 0,4x2,5x80; 1x 0,6x3,5x100; 1x 0,8x4,0x100; 1x 1,0x5,5x125		

410 i VDE B VDE-insulated T-handle adapter screwdriver for 3/8" sockets

The shape of the T-handle allows a transmission of particularly high tightening and loosening torque. The geometry of the handle fills the hand well and the fingers lie safely in the soft rounded handle recesses.

This ensures optimal, ergonomic power transmission. Individually tested tool as per IEC 60900 at 10,000 V for safe working at the approved voltage of 1,000 V.

Only allowed for 3/8" VDE bit sockets and sockets of the Wera Zyklop VDE series 8740, 8760, 8767, 8790. The coated handle protects even sensitive surfaces from damage.

- 3/8" VDE T-handle screwdriver for the transmission of particularly high tightening and loosening torque
- Ergonomic 2-component T-handle with handle recesses and a pleasant feel for a very high power transmission and fatigue-free working.
- Insulated, individually tested tool as per IEC 60900 for safe working up to 1.000 V
- Only allowed for 3/8" VDE bit sockets and sockets of the Wera Zyklop VDE series 8740, 8760, 8767, 8790

410 i VDE B VDE-insulated T-handle adapter screwdriver for 3/8" sockets

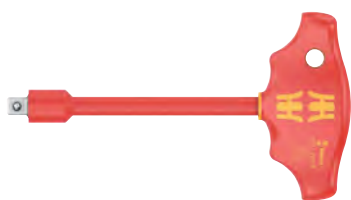

Code		EAN		mm		mm		mm		mm		1	
05005120001		4013288 222664		3/8"		130		49		99			5 1/8"

8100 SB VDE 1 Zyklop Ratchet set, insulated, switch lever, 3/8" drive, metric

Incredibly compact set arrangement for a lot of tools in a small space. Individually tested ratchet, sockets and extensions as per IEC 60900 at 10,000V for safe working at the approved voltage of 1,000V.

Textile box with very high robustness and durability can be positioned upright for clear storage in the workshop shelf. Additional surface protection through textile outer material. Low weight and volume for easier mobility. Smooth turning mechanism for secure hold and easy removal of VDE sockets.

- Insulated and 100% individually tested Zyklop ratchets, sockets and extensions for safe working up to 1,000 volts
- Fine-toothed ratchet with 80 teeth for a short return angle of 4.5°
- Extremely slim design with a soft, ergonomic grip zone for easy work even in very confined spaces
- Robust and extremely compact textile box with socket holders, which ensure a secure hold and easy socket removal by means of a rotating mechanism
- Tools and textile box protect sensitive surfaces, the box is Wera 2go compatible

8100 SB VDE 1 Zyklop Ratchet set, insulated, switch lever, 3/8" drive, metric



Code		EAN		1
05004970001		4013288 190970		
		8007 B VDE 1x 3/8"x222,0		
		8790 B VDE 1x 6,0x46,0; 1x 7,0x46,0; 1x 8,0x46,0; 1x 9,0x46,0; 1x 10,0x46,0; 1x 11,0x46,0; 1x 12,0x46,0; 1x 13,0x46,0; 1x 14,0x46,0; 1x 15,0x46,0; 1x 16,0x46,0; 1x 17,0x46,0; 1x 18,0x46,0; 1x 19,0x46,0		
		8794 SB VDE 1x 3/8"x91,0		
		8794 LB VDE 1x 3/8"x166,0		

Belt B VDE 1 Zyklop bit socket set TORX® hexagonal socket with holding function, 3/8" drive

10 Zyklop bit sockets, with 3/8" drive, insulated, individually tested as per IEC 60900. Increased safety due to 2-component isolation with yellow core under red insulation outer layer visible in case of damage to outer red VDE insulation layer. With holding function for TORX® screws to Acument Intellectual Properties specifications or holding function for hexagonal socket screws. Robust textile belt in the typical Wera design with 10 VDE bit sockets in a compact space. A smooth turning mechanism ensures secure holding and easy removal of the sockets. Includes snap hook for attaching to belt loops or bags. With fleece backing and hook and loop fastener strips for easy attachment e.g. on wall, shelf, workshop trolley and Wera 2go tool transport system. VDE 3/8" bit socket and holding function for particularly comfortable screwdriving with reduced risk of screw loss when feeding to the component. With increased safety due to yellow insulation core, which becomes visible in case of damage to the outer red VDE insulation layer. Individually tested tool as per IEC 60900 at 10,000 V for safe working at the approved voltage of 1,000 V.

- 10-piece 3/8" socket set on robust textile belt
- Smooth Twist to Unlock mechanism for a secure fit and simple removal of the sockets
- Extremely short and compact 3/8" bit socket for easy work even in very confined spaces
- The holding function holds screws securely on the tool
- Individually tested tool as per IEC 60900 at 10,000 V for safe working at up to 1,000 volts
- Suitable for attachment to a wall, shelf, tool trolley and to the Wera 2go System

Belt B VDE 1 Zyklop bit socket set TORX® hexagonal socket with holding function, 3/8" drive



	Code	EAN			
	05004930001	4013288	210234		1
				8767 B VDE HF 1x TX 20x55,0; 1x TX 25x55,0; 1x TX 27x55,0; 1x TX 30x55,0; 1x TX 40x55,0; 1x TX 45x59,0	
				8740 B VDE HF 1x 4,0x55,0; 1x 5,0x55,0; 1x 6,0x55,0; 1x 8,0x59,0	
				Belt B VDE 0/10 1x 71,0x209,0	
				K30 1x 30,0x200,0	

8007 B VDE Zyklop ratchet, insulated, with switch lever, with 3/8" drive

- Insulated and 100% individually tested Zyklop ratchet for safe working up to 1,000 volts
- Fine toothing with 80 teeth for a short return angle of only 4.5°
- Extremely slim design with a soft, ergonomic grip zone for easy work even in very confined spaces
- Safe socket lock via push button, convenient direction change thanks to the reversing lever
- Plastic coating protects surfaces from damage

8007 B VDE Zyklop ratchet, insulated, with switch lever, with 3/8" drive

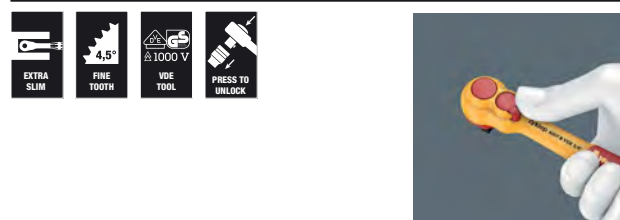

	Code	EAN							
	05004966001	4013288	190963	3/8"	222,0				3

8790 B VDE Zyklop 3/8" socket, insulated

- Individually tested tool as per IEC 60900 at 10,000V
- Increased safety due to 2-component isolation with yellow insulation core under red insulation outer layer
- Plastic coating protects surfaces from damage

8790 B VDE Zyklop 3/8" socket, insulated



Code	EAN	⌀	⌀	⌀	⌀		
05004950001	192936	6,0	46,0	14,8	23,0		1
05004951001	192943	7,0	46,0	15,7	23,0		1
05004952001	192950	8,0	46,0	17,0	23,0		1
05004953001	192967	9,0	46,0	18,2	23,0		1
05004954001	192974	10,0	46,0	19,4	23,0		1
05004955001	192981	11,0	46,0	20,7	23,0		1
05004956001	192998	12,0	46,0	23,0	23,0		1
05004957001	193001	13,0	46,0	23,0	23,0		1
05004958001	193018	14,0	46,0	24,7	23,0		1
05004959001	193025	15,0	46,0	26,0	23,0		1
05004960001	193032	16,0	46,0	26,8	23,0		1
05004961001	193049	17,0	46,0	29,0	23,0		1
05004962001	193056	18,0	46,0	29,6	23,0		1
05004963001	193063	19,0	46,0	30,7	23,0		1

8767 B VDE HF TORX® Zyklop bit socket, insulated, with holding function, 3/8" drive

- The holding function holds screws securely on the tool
- Extremely short and compact 3/8" bit socket for easy work even in very confined spaces

8767 B VDE HF TORX® Zyklop bit socket, insulated, with holding function, 3/8" drive



Code	EAN	⌀	⌀	⌀		
05004920001	210173	TX 20	55,0	23,0	9,0	1
05004921001	210180	TX 25	55,0	23,0	9,0	1
05004922001	210197	TX 27	55,0	23,0	9,0	1
05004923001	210203	TX 30	55,0	23,0	9,0	1
05004924001	210210	TX 40	55,0	23,0	9,0	1
05004925001	210227	TX 45	59,0	23,0	13,0	1

8740 B VDE HF Zyklop Hex bit socket, insulated, with holding function, 3/8" drive

- The holding function holds screws securely on the tool
- Extremely short and compact 3/8" bit socket for easy work even in very confined spaces

8740 B VDE HF Zyklop Hex bit socket, insulated, with holding function, 3/8" drive



Code	EAN	⌀	⌀	⌀	⌀		
05004900001	210135	4,0	55,0	23,0	9,0		1
05004901001	210142	5,0	55,0	23,0	9,0		1
05004902001	210159	6,0	55,0	23,0	9,0		1
05004903001	210166	8,0	59,0	23,0	13,0		1

8760 B VDE XZN Zyklop bit socket, insulated, 3/8" drive, for multi-point socket screws

- Extremely short and compact 3/8" bit socket for easy work even in very confined spaces

8760 B VDE XZN Zyklop bit socket, insulated, 3/8" drive, for multi-point socket screws



Code	EAN	⌀	⌀	⌀		
05004940001	211453	M 8	59,0	23,0	13,0	1
05004941001	211460	M 10	59,0	23,0	13,0	1
05004942001	211477	M 12	59,0	23,0	13,0	1

8794 LB VDE Zyklop extension, insulated, long, 3/8"

- 3/8" VDE Zyklop extension
- Individually tested tool as per IEC 60900 at 10,000 V
- Increased safety due to 2-component isolation with yellow insulation core under red insulation outer layer
- Plastic coating protects surfaces from damage
- Long version

8794 LB VDE Zyklop extension, insulated, long, 3/8"



	EAN	□	⌈							
Code	4013288		mm							
05004965001	190956	3/8"	166,0							1

8794 SB VDE Zyklop extension, insulated, short, 3/8"

- Short version

8794 SB VDE Zyklop extension, insulated, short, 3/8"



	EAN	□	⌈							
Code	4013288		mm							
05004964001	190949	3/8"	91,0							1

Socket rail B VDE (textile belt), 10 location, unloaded

- Empty textile belt for 10 VDE socket wrench/bit socket inserts, 3/8"
- Includes a convenient snap hook
- Smooth Twist to Unlock mechanism for a secure fit and simple removal of the sockets
- Suitable for attachment to a wall, shelf, tool trolley and to the Wera 2go System



Socket rail B VDE (textile belt), 10 location, unloaded



Code	EAN		
05003982001	4013288		1
	210913	Belt B VDE 0/10 1x 71,0x209,0	
		K30 1x 30,0x200,0	

6004 Joker VDE 4 Set 1 VDE-insulated self-setting spanner set

Individually tested tools as per IEC 60900 at 10,000 V for safe working at the approved voltage of 1.000 V. The adjustable VDE spanner continuously and automatically grips all hexagonal sizes in the indicated range of dimensions - metric and imperial.

The integrated lever mechanism securely clamps the hexagon screw or bolt between the jaws, which significantly reduces the risk of slippage or damage. The ratchet feature ensures fast and consistent screwdriving without removing the tool.

By using the corner-width rectangular prisms, a back-pivoting angle of only 30° can be achieved. The single-arm design, in conjunction with the ratchet feature and the corner-width prism, makes it possible to work even in confined spaces.

The adjustable Joker 6004 VDE has a naturally comfortable handle thanks to the 2-component plastic insulation.

Safety is increased by the anti-slip protection at the front end of the handle. The sliding function offers contactless and safe opening of the non-insulated jaws, thereby providing extra protection.

- The compact textile box with four adjustable Joker 6004 VDE covers all metric and imperial dimensions in the field of application from 7 to 19 mm or ¼" to ¾"

6004 Joker VDE 4 Set 1 VDE-insulated self-setting spanner set



Code	EAN		
05020170001	221803		1
		6004 Joker VDE XS 1x 7-10 (1/4"-3/8")x119	
		6004 Joker VDE S 1x 10-13 (7/16"-1/2")x155	
		6004 Joker VDE M 1x 13-16 (1/2"-3/8")x190	
		6004 Joker VDE L 1x 16-19 (5/8"-3/4")x226	
		Hook and Loop Fastener Strip 120 1x 50,0x120,0	

6004 Joker VDE VDE-insulated, self-setting spanner

Individually tested tools as per IEC 60900 at 10,000 V for safe working at the approved voltage of 1.000 V. The adjustable VDE spanner continuously and automatically grips all hexagonal sizes in the indicated range of dimensions – metric and imperial.

The integrated lever mechanism securely clamps the hexagon screw or bolt between the jaws, which significantly reduces the risk of slippage or damage.

The ratchet feature ensures fast and consistent screwdriving without removing the tool. By using the corner-width rectangular prisms, a back-pivoting angle of only 30° can be achieved.

The single-arm design, in conjunction with the ratchet feature and the corner-width prism, makes it possible to work even in confined spaces.

The adjustable Joker 6004 VDE has a naturally comfortable handle thanks to the 2-component plastic insulation. Safety is increased by the anti-slip protection at the front end of the handle.

The sliding function offers contactless and safe opening of the non-insulated jaws, thereby providing extra protection.

- The adjustable Joker 6004 VDE covers all metric and imperial dimensions in the respective field of application
- Individually tested tools with insulated handles for safe working up to 1,000 volt, with anti-slip protection and sliding function for contactless and safe opening of the non-insulated jaws
- Automatic and continuous grip of hexagon screws and bolts
- Lever mechanism when gripping avoids slipping and damage
- Fast and consistent screwdriving without removing the wrench thanks to mechanical ratchet function
- Return angle of only 30° through placement in the corner-width rectangular prisms in the mouth

6004 Joker VDE XS VDE-insulated, self-setting spanner



Code	EAN					
05020150001 ¹⁾	221797	7-10	1/4"-3/8"	119	7,7	3

6004 Joker VDE S VDE-insulated, self-setting spanner



	EAN						
Code	4013288	mm		mm	mm		
05020151001 ¹⁾	221766	10-13	7/16"-1/2"	155	10		3

6004 Joker VDE M VDE-insulated, self-setting spanner

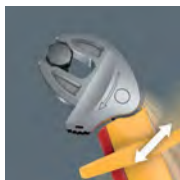

	EAN						
Code	4013288	mm		mm	mm		
05020152001 ¹⁾	221780	13-16	1/2"-5/8"	190	12,4		3

6004 Joker VDE L VDE-insulated self-setting spanner

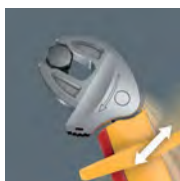

	EAN						
Code	4013288	mm		mm	mm		
05020153001 ¹⁾	221773	16-19	5/8"-3/4"	226	14		3

400 i VDE Hex Insulated torque-indicator

Wera VDE torque indicator with fixed torque for hexagon socket screws. Tamper proof. The robust slip clutch generates a clearly audible and tactile trigger that signals when the set torque is reached, making it impossible to apply any further torque. The loosening torque value is significantly higher than the set tightening torque, therefore no additional tools are needed for loosening screw connections. The shape of the handle perfectly fills the whole hand and fingers comfortably lie in the softly rounded recessed grips. This ensures optimal, ergonomic power transfer. Individually tested tool as per IEC 60900 at 10,000 V for safe working at the approved voltage of 1,000 V.



- Insulated, individually tested VDE T-handle torque indicator for safe working up to 1,000V
- T-handle is ideal for transferring controlled tightening torque and high loosening torque
- Error-free screwdriving due to non-slip friction clutch and exact torque transmission
- Distinctly audible and noticeable excess-load signal when the pre-set torque is reached
- Tamper-proof against accidental changing of set torque value

400 i VDE Hex Insulated torque-indicator



	EAN									
Code	4013288		Nm	mm	mm	mm				
05004980001	206398	4,0	5,0	90	48	100	3 1/2"			1
05004981001	206114	5,0	5,0	90	48	100	3 1/2"			1





Ratchets & Accessories

Zyklop Speed - incredibly fast and incredibly flexible



Incredibly compact set arrangement with many tools in a minimum of space. A completely new ratchet set feeling thanks to the unique textile boxes that are very robust and durable.

They can be positioned upright for tidy storage on the workshop shelf. Additional surface protection due to textile outer material. Low weight and volume for simpler mobility. Take it easy Tool Finder with colour coding according to sizes.

- 42-piece ratchet set in robust textile box
- Freely pivoting ratchet head with 5 predefined locking positions
- Bit-sockets with all the advantages of the Wera bit technology
- TORX®, hex plus and hexagon nuts with holding function for screws / nuts
- Take it easy tool finder with colour coding according to sizes
- Suitable for Wera 2go

8100 SA All-in Zyklop Speed Ratchet Set, 1/4" drive, with holding function, metric



Code	EAN		
	4013288		
05003755001	190994		1
		8000 A 1x 1/4"x152,0	
		8796 LA 1x 1/4"x150,0	
		8794 A 1x 1/4"x56,0	
		8790 HMA HF 1x 4,0x23,0; 1x 4,5x23,0; 1x 5,0x23,0; 1x 5,5x23,0; 1x 6,0x23,0; 1x 7,0x23,0; 1x 8,0x23,0; 1x 9,0x23,0; 1x 10,0x23,0; 1x 11,0x23,0; 1x 12,0x23,0; 1x 13,0x23,0; 1x 14,0x23,0	
		8767 A HF 1x TX 8x28,0; 1x TX 9x28,0; 1x TX 10x28,0; 1x TX 15x28,0; 1x 3,7x3,7xTX 20x28,0; 1x 4,1x4,1xTX 25x28,0; 1x 4,8x4,8xTX 27x28,0; 1x 5,4x5,4xTX 30x28,0; 1x 6,5x6,5xTX 40x28,0	
		8740 A 1x 2,0x28,0; 1x 2,5x28,0	
		8740 A HF 1x 3,0x28,0; 1x 4,0x28,0; 1x 5,0x28,0; 1x 6,0x28,0; 1x 7,0x28,0; 1x 8,0x28,0	
		8751 A 1x PH 1x28,0; 1x PH 2x28,0; 1x PH 3x28,0	
		8755 A 1x PZ 1x28,0; 1x PZ 2x28,0; 1x PZ 3x28,0	
		8700 A FL 1x 0,8x5,5x28,0; 1x 1,2x6,5x28,0	
		ME1 1x 14,0x43,0	

8100 SA 6 Zyklop Speed Ratchet Set, 1/4" drive, metric

- Freely pivoting ratchet head with 5 predefined locking positions
- Fine toothing with 72 teeth
- Small return angle of only 5°
- Free-turning sleeve for high working speeds
- Take it easy tool finder with colour coding according to sizes
- Compact textile box with high robustness, low weight and volume

8100 SA 6 Zyklop Speed Ratchet Set, 1/4" drive, metric



Code	EAN			
05004016001	174000			1
		8000 A 1x 1/4"x152,0		
		8790 HMA 1x 5,0x23,0; 1x 5,5x23,0; 1x 6,0x23,0; 1x 7,0x23,0; 1x 8,0x23,0; 1x 10,0x23,0; 1x 11,0x23,0; 1x 12,0x23,0; 1x 13,0x23,0		
		8794 LA 1x 1/4"x150,0		
		8794 A 1x 1/4"x56,0		
		8784 A1 1x 1/4"x1/4"x37,0		
		851/4 TZ PH 1x PH 1x50; 1x PH 2x50; 1x PH 3x50		
		855/4 TZ PZ 1x PZ 1x50; 1x PZ 2x50		
		867/4 Z TORX® 1x TX 10x50; 1x TX 15x50; 1x TX 20x50; 1x TX 25x50; 1x TX 27x50; 1x TX 30x50		
		840/4 Z Hex-Plus 1x 3,0x50; 1x 4,0x50; 1x 5,0x50; 1x 6,0x50		

8100 SA 9 Zyklop Speed Ratchet Set, 1/4" drive, imperial



Code	EAN			
05004019001	173843			1
		8000 A 1x 1/4"x152,0		
		8790 HMA 1x 3/16"x23,0; 1x 7/32"x23,0; 1x 1/4"x23,0; 1x 9/32"x23,0; 1x 5/16"x23,0; 1x 11/32"x23,0; 1x 3/8"x23,0; 1x 7/16"x23,0; 1x 1/2"x23,0		
		8794 LA 1x 1/4"x150,0		
		8794 A 1x 1/4"x56,0		
		8784 A1 1x 1/4"x1/4"x37,0		
		851/4 TZ PH 1x PH 1x50; 1x PH 2x50; 1x PH 3x50		
		855/4 TZ PZ 1x PZ 1x50; 1x PZ 2x50		
		867/4 Z TORX® 1x TX 10x50; 1x TX 15x50; 1x TX 20x50; 1x TX 25x50; 1x TX 27x50; 1x TX 30x50		
		840/4 Z Hex-Plus 1x 3/32"x50; 1x 1/16"x50; 1x 7/32"x50; 1x 1/4"x50		

Kraftform Kompakt Zyklop MS1 Metal/Speed 1/4"

- Incredibly fast 1/4" Zyklop Speed ratchet with pivoting ratchet head and 5 predefined locking positions
- Extremely slim Zyklop Metal ratchet with long lever
- Return angle of only 5°
- Convenient direction change thanks to switchover lever
- Set in robust textile box

Kraftform Kompakt Zyklop MS1 Metal/Speed 1/4"



Code	EAN		
05135949001	178633		1
		<input type="checkbox"/> 8000 A 1x 1/4"x152,0	
		<input type="checkbox"/> 8004 A 1x 1/4"x141,0	
		<input checked="" type="checkbox"/> 8796 LA 1x 1/4"x150,0	
		<input checked="" type="checkbox"/> 8794 LA 1x 1/4"x150,0	
		<input checked="" type="checkbox"/> 8794 SA 1x 1/4"x75,0	
		<input checked="" type="checkbox"/> 8784 A1 1x 1/4"x1/4"x37,0	
		<input checked="" type="checkbox"/> 8794 A 1x 1/4"x56,0	
		<input checked="" type="checkbox"/> 8795 A 1x 1/4"x35,5	

8100 SA 2 Zyklop Speed Ratchet Set, 1/4" drive, metric

- 42-piece set in a robust metal case

8100 SA 2 Zyklop Speed Ratchet Set, 1/4" drive, metric



Code	EAN		
05003533001	121103		1
		<input type="checkbox"/> 8000 A 1x 1/4"x152,0	
		<input checked="" type="checkbox"/> 8790 HMA 1x 4,0x23,0; 1x 4,5x23,0; 1x 5,0x23,0; 1x 5,5x23,0; 1x 6,0x23,0; 1x 7,0x23,0; 1x 8,0x23,0; 1x 9,0x23,0; 1x 10,0x23,0; 1x 11,0x23,0; 1x 12,0x23,0; 1x 13,0x23,0; 1x 14,0x23,0	
		<input type="checkbox"/> 8789 A 1x 1/4"x110,0	
		<input checked="" type="checkbox"/> 8794 A 1x 1/4"x56,0	
		<input checked="" type="checkbox"/> 8795 A 1x 1/4"x35,5	
		<input checked="" type="checkbox"/> 8784 A1 1x 1/4"x1/4"x37,0	
		<input checked="" type="checkbox"/> 8796 SA 1x 1/4"x75,0	
		<input checked="" type="checkbox"/> 8796 LA 1x 1/4"x150,0	
		<input checked="" type="checkbox"/> 851/1 Z PH 1x PH 1x25; 1x PH 2x25; 1x PH 3x25	
		<input checked="" type="checkbox"/> 855/1 Z PZ 1x PZ 1x25; 1x PZ 2x25; 1x PZ 3x25	
		<input checked="" type="checkbox"/> 867/1 Z TORX® BO 1x TX 8x25; 1x TX 9x25; 1x TX 10x25; 1x TX 15x25; 1x TX 20x25; 1x TX 25x25; 1x TX 30x25; 1x TX 40x25	
		<input type="checkbox"/> 840/1 Z Hex-Plus 1x 3,0x25; 1x 4,0x25; 1x 5,0x25; 1x 6,0x25; 1x 8,0x25	
		<input type="checkbox"/> 800/1 Z 1x 0,6x4,5x25; 1x 1,0x5,5x25; 1x 1,2x8,0x25	

8100 SA 4 Zyklop Speed Ratchet Set, 1/4" drive, imperial

- 41-piece set in a robust metal case

8100 SA 4 Zyklop Speed Ratchet Set, 1/4" drive, imperial



Code	EAN		
05003535001	4013288 121127		1
		8000 A 1x 1/4"x152,0	
		8790 HMA 1x 3/16"x23,0; 1x 7/32"x23,0; 1x 1/4"x23,0; 1x 9/32"x23,0; 1x 5/16"x23,0; 1x 11/32"x23,0; 1x 3/8"x23,0; 1x 7/16"x23,0; 1x 1/2"x23,0; 1x 9/16"x23,0	
		8789 A 1x 1/4"x110,0	
		8794 A 1x 1/4"x56,0	
		8795 A 1x 1/4"x35,5	
		8784 A1 1x 1/4"x1/4"x37,0	
		8796 SA 1x 1/4"x75,0	
		8796 LA 1x 1/4"x150,0	
		851/1 Z PH 1x PH 1x25; 1x PH 2x25; 1x PH 3x25	
		855/1 Z PZ 1x PZ 1x25; 1x PZ 2x25; 1x PZ 3x25	
		867/1 Z TORX® B0 1x TX 8x25; 1x TX 9x25; 1x TX 10x25; 1x TX 15x25; 1x TX 20x25; 1x TX 25x25; 1x TX 30x25; 1x TX 40x25	
		840/1 Z Hex-Plus 1x 5/64"x25; 1x 3/32"x25; 1x 1/8"x25; 1x 9/64"x25; 1x 5/32"x25; 1x 3/16"x25; 1x 7/32"x25	
		800/1 Z 1x 0,6x4,5x25; 1x 1,0x5,5x25; 1x 1,2x8,0x25	

8100 SA/SC 2 Zyklop Speed Ratchet Set, 1/4" drive and 1/2" drive, metric

- 43-piece set in a robust metal case

8100 SA/SC 2 Zyklop Speed Ratchet Set, 1/4" drive and 1/2" drive, metric



Code	EAN		
05160785001	4013288 126610		1
		8000 A 1x 1/4"x152,0	
		8790 HMA 1x 4,0x23,0; 1x 4,5x23,0; 1x 5,0x23,0; 1x 5,5x23,0; 1x 6,0x23,0; 1x 7,0x23,0; 1x 8,0x23,0; 1x 9,0x23,0; 1x 10,0x23,0; 1x 12,0x23,0; 1x 13,0x23,0	
		8784 A1 1x 1/4"x1/4"x37,0	
		8796 LA 1x 1/4"x150,0	
		8000 C 1x 1/2"x277,0	
		8790 HMC 1x 13,0x37,0; 1x 14,0x37,0; 1x 15,0x37,0; 1x 16,0x37,0; 1x 17,0x37,0; 1x 18,0x37,0; 1x 19,0x37,0; 1x 21,0x37,0; 1x 22,0x37,0; 1x 24,0x37,0	
		8796 LC 1x 1/2"x250,0	
		816 R 1x 1/4"x119	
		800/4 Z 1x 1,0x5,5x89	
		840/4 Z Hex-Plus 1x 3,0x89; 1x 4,0x89; 1x 5,0x89; 1x 6,0x89	
		851/4 Z PH 1x PH 1x89; 1x PH 2x89; 1x PH 3x89	
		855/4 Z PZ 1x PZ 1x89; 1x PZ 2x89; 1x PZ 3x89	
		867/4 Z TORX® B0 1x TX 10x89; 1x TX 15x89; 1x TX 20x89; 1x TX 25x89; 1x TX 30x89	

Zyklop Metal with push-through square

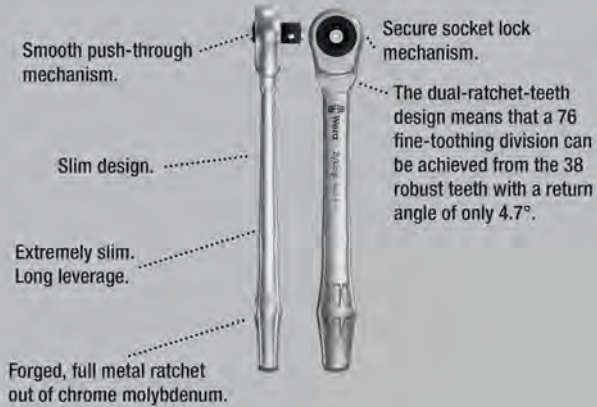

Incredibly compact set arrangement with many tools in a minimum of space. A completely new ratchet set feeling thanks to the unique textile boxes that are very robust and durable. They can be positioned upright for tidy storage on the workshop shelf. Additional surface protection due to textile outer material. Low weight and volume for simpler mobility.

Take it easy Tool Finder with colour coding according to sizes.

- Extremely slim ratchet with long lever
- Return angle of only 4.7°
- Absolutely smooth switchover of the non-detachable push-through square
- Take it easy tool finder system

8100 SA 7 Zyklop Metal Ratchet Set with push-through square, 1/4" drive, metric



Code	EAN		
05004017001	4013288 173898		1
		8003 A 1x 1/4"x141,0	
		8790 HMA 1x 5,0x23,0; 1x 5,5x23,0; 1x 6,0x23,0; 1x 7,0x23,0; 1x 8,0x23,0; 1x 10,0x23,0; 1x 11,0x23,0; 1x 12,0x23,0; 1x 13,0x23,0	
		8794 LA 1x 1/4"x150,0	
		8794 A 1x 1/4"x56,0	
		8784 A1 1x 1/4"x1/4"x37,0	
		851/1 Z PH 1x PH 1x25; 1x PH 2x25; 1x PH 3x25	
		855/1 Z PZ 1x PZ 1x25; 1x PZ 2x25	
		867/1 TORX® 1x TX 10x25; 1x TX 15x25; 1x TX 20x25; 1x TX 25x25; 1x TX 27x25; 1x TX 30x25	
		840/1 Z Hex-Plus 1x 3,0x25; 1x 4,0x25; 1x 5,0x25; 1x 6,0x25	

8100 SA 10 Zyklop Metal Ratchet Set with push-through square, 1/4" drive, imperial



Code	EAN		
05004020001	4013288 173904		1
		8003 A 1x 1/4"x141,0	
		8790 HMA 1x 3/16"x23,0; 1x 7/32"x23,0; 1x 1/4"x23,0; 1x 3/32"x23,0; 1x 5/16"x23,0; 1x 11/32"x23,0; 1x 3/8"x23,0; 1x 7/16"x23,0; 1x 1/2"x23,0	
		8794 LA 1x 1/4"x150,0	
		8794 A 1x 1/4"x56,0	
		8784 A1 1x 1/4"x1/4"x37,0	
		851/1 Z PH 1x PH 1x25; 1x PH 2x25; 1x PH 3x25	
		855/1 Z PZ 1x PZ 1x25; 1x PZ 2x25	
		867/1 TORX® 1x TX 10x25; 1x TX 15x25; 1x TX 20x25; 1x TX 25x25; 1x TX 27x25; 1x TX 30x25	
		840/1 Z Hex-Plus 1x 3/32"x25; 1x 3/16"x25; 1x 7/32"x25; 1x 1/4"x25	

8003 A Zyklop Metal Ratchet with push-through square and 1/4" drive

- For 1/4" square sockets with ball lock
- Forged, full metal ratchet (chrome-molybdenum); slim design to enable work in very confined spaces.
- The dual-ratchet-teeth design means that a 76 fine-toothing division can be achieved from the 38 robust teeth with a return angle of only 4.7°.
- Absolutely smooth switchover of the non-detachable push-through square

8003 A Zyklop Metal Ratchet with push-through square and 1/4" drive



Code	EAN	Socket	Length	Width	Height	Weight	Volume
05004003001	174017	1/4"	141,0	21	22		3

Zyklop Metal with switch lever



Incredibly compact set arrangement with many tools in a minimum of space. A completely new ratchet set feeling thanks to the unique textile boxes that are very robust and durable.

They can be positioned upright for tidy storage on the workshop shelf. Additional surface protection due to textile outer material. Low weight and volume for simpler mobility.

Take it easy Tool Finder with colour coding according to sizes.

- Convenient direction change thanks to switchover lever
- Extremely slim ratchet with long lever
- Return angle of only 5°

8100 SA 8 Zyklop Metal Ratchet Set with switch lever, 1/4" drive, metric



Code	EAN	Socket	Length	Width	Height	Weight	Volume	
05004018001	173836	1/4"	141,0	21	22		3	
		8004 A	1x 1/4"x141,0					
		8790 HMA	1x 5,0x23,0; 1x 5,5x23,0; 1x 6,0x23,0; 1x 7,0x23,0; 1x 8,0x23,0; 1x 10,0x23,0; 1x 11,0x23,0; 1x 12,0x23,0; 1x 13,0x23,0					
		8794 LA	1x 1/4"x150,0					
		8794 A	1x 1/4"x56,0					
		8784 A1	1x 1/4"x1/4"x37,0					
		851/1 Z PH	1x PH 1x25; 1x PH 2x25; 1x PH 3x25					
		855/1 Z PZ	1x PZ 1x25; 1x PZ 2x25					
		867/1 TORX®	1x TX 10x25; 1x TX 15x25; 1x TX 20x25; 1x TX 25x25; 1x TX 27x25; 1x TX 30x25					
		840/1 Z Hex-Plus	1x 3,0x25; 1x 4,0x25; 1x 5,0x25; 1x 6,0x25					

8100 SA 11 Zyklop Metal Ratchet Set with switch lever, 1/4" drive, imperial



Code	EAN			
05004021001	4013288 173850			1
		8004 A	1x 1/4"x141,0	
		8790 HMA	1x 3/16"x23,0; 1x 7/32"x23,0; 1x 1/4"x23,0; 1x 9/32"x23,0; 1x 5/16"x23,0; 1x 11/32"x23,0; 1x 3/8"x23,0; 1x 7/16"x23,0; 1x 1/2"x23,0	
		8794 LA	1x 1/4"x150,0	
		8794 A	1x 1/4"x56,0	
		8784 A1	1x 1/4"x1/4"x37,0	
		851/1 Z PH	1x PH 1x25; 1x PH 2x25; 1x PH 3x25	
		855/1 Z PZ	1x PZ 1x25; 1x PZ 2x25	
		867/1 TORX®	1x TX 10x25; 1x TX 15x25; 1x TX 20x25; 1x TX 25x25; 1x TX 27x25; 1x TX 30x25	
		840/1 Z Hex-Plus	1x 5/32"x25; 1x 3/16"x25; 1x 7/32"x25; 1x 1/4"x25	

8100 SA 12 HF Zyklop Metal Ratchet Set with switch lever, 1/4" drive, metric

- Sockets with holding function for screws/bolts/nuts

8100 SA 12 HF Zyklop Metal Ratchet Set with switch lever, 1/4" drive, metric



Code	EAN			
05003756001	4013288 190987			1
		8004 A	1x 1/4"x141,0	
		8794 LA	1x 1/4"x150,0	
		8794 A	1x 1/4"x56,0	
		8790 HMA HF	1x 5,0x23,0; 1x 5,5x23,0; 1x 6,0x23,0; 1x 7,0x23,0; 1x 8,0x23,0; 1x 10,0x23,0; 1x 11,0x23,0; 1x 12,0x23,0; 1x 13,0x23,0	
		ME1	1x 14,0x43,0	

8004 A Zyklop Metal Ratchet with switch lever and 1/4" drive

- Convenient direction change thanks to switchover lever
- Extremely slim ratchet with long lever
- Return angle of only 5°
- Secure socket locking

8004 A Zyklop Metal Ratchet with switch lever and 1/4" drive

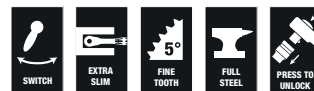

Code	EAN						
05004004001	4013288 174024	1/4"	mm	mm	mm		3
		141,0	19	22			

8790 HMA Zyklop 1/4" socket

- 1/4" Zyklop socket
- For manual and power tool operations (non-impact)
- Knurling at lower end to enable easy gripping when used in manual applications
- Equipped with ball stop groove
- Take it easy tool finder with colour coding according to sizes

8790 HMA Zyklop 1/4" socket



Code	EAN							
Code	4013288		mm		mm	mm	mm	
05003501001	120083		4,0		23,0	6,9	13,0	1
05003502001	120106		4,5		23,0	7,5	13,0	1
05003503001	120113		5,0		23,0	8,2	13,0	1
05003504001	120120		5,5		23,0	8,8	13,0	1
05003505001	120137		6,0		23,0	9,4	13,0	1
05003506001	120144		7,0		23,0	11,0	13,0	1
05003507001	120151		8,0		23,0	12,0	13,0	1
05003508001	120090		9,0		23,0	13,0	14,0	1
05003509001	120168		10,0		23,0	14,5	14,5	1
05003510001	120175		11,0		23,0	16,0	15,0	1
05003511001	120182		12,0		23,0	17,0	16,0	1
05003512001	120199		13,0		23,0	18,0	17,0	1
05003513001	120205		14,0		23,0	20,0	18,0	1
05003499001	206862		15,0		23,0	21,5	19,0	1
05003514001	120212			3/16"	23,0	7,5	13,0	1
05003515001	120229			7/32"	23,0	8,8	13,0	1
05003516001	120236			1/4"	23,0	11,0	13,0	1
05003517001	120243			9/32"	23,0	11,0	13,0	1
05003518001	120250			5/16"	23,0	12,0	13,0	1
05003519001	120267			11/32"	23,0	13,0	14,0	1
05003520001	120274			3/8"	23,0	14,5	14,5	1
05003521001	120281			7/16"	23,0	16,0	15,0	1
05003522001	120298			1/2"	23,0	18,0	17,0	1
05003523001	120304			9/16"	23,0	20,0	18,0	1

8790 HMA HF Zyklop socket with 1/4" drive with holding function

- Socket (non-impact) for manual or power tool operations
- The holding function holds screws securely on the tool
- Take it easy tool finder with colour coding according to sizes
- Chrome vanadium steel, matt chrome-plated
- Equipped with ball stop groove, knurling at lower end for better gripping

8790 HMA HF Zyklop socket with 1/4" drive with holding function



Code	EAN							
Code	4013288		mm	mm	mm	mm		
05003717001	185631		4,0	23,0	7,0	11,0		1
05003718001	185648		4,5	23,0	7,8	11,0		1
05003719001	185655		5,0	23,0	8,9	11,0		1
05003720001	185662		5,5	23,0	9,2	11,0		1
05003721001	185679		6,0	23,0	10,5	11,0		1
05003722001	185686		7,0	23,0	11,9	11,0		1
05003723001	185693		8,0	23,0	12,9	11,0		1
05003724001	185709		9,0	23,0	14,1	12,0		1
05003725001	185716		10,0	23,0	15,6	12,5		1
05003726001	185723		11,0	23,0	17,4	13,0		1
05003727001	185730		12,0	23,0	18,4	14,0		1
05003728001	185747		13,0	23,0	19,5	15,0		1
05003729001	185754		14,0	23,0	20,8	16,0		1
05003010001	206855		15,0	23,0	21,5	18,5		1

Belt A 1 Zyklop socket set with holding function, 1/4" drive

Typically Wera designed robust textile belt with 9 sockets taking up minimal space. A Smooth Twist to Unlock mechanism ensures a secure fit and simple removal of the sockets.

Comes with Take it easy Tool Finder with colour coding according to size to enable the right tool to be selected easily and quickly. Includes a snap hook for secure fastening to a belt loop or pocket.

Sockets with holding function for particularly convenient screw-driving with reduced risk of losing the screw when approaching the workpiece.

Supplied with a non-woven reverse side and hook and loop strips for simple attachment e.g. to a wall, shelf, tool trolley and to the Wera 2go tool transport system.

- 10-piece socket set on a robust textile belt, 1/4"
- Sockets with holding function for screws/bolts/nuts
- Smooth Twist to Unlock mechanism for a secure fit and simple removal of the sockets
- Take it easy tool finder with colour coding according to sizes
- Suitable for attachment to a wall, shelf, tool trolley and to the Wera 2go System

Belt A 1 Zyklop socket set with holding function, 1/4" drive



Code		EAN		
05003880001		4013288 190758		1
		●	8790 HMA HF 1x 4,0x23,0; 1x 4,5x23,0; 1x 5,0x23,0; 1x 5,5x23,0; 1x 6,0x23,0; 1x 7,0x23,0; 1x 8,0x23,0; 1x 10,0x23,0; 1x 13,0x23,0	
			ME1 1x 14,0x43,0	
			Belt A 0/9 1x 39,0x238,0	
			K30 1x 30,0x200,0	

Nut Extractor

- Simple removal of nuts contained within Wera HF sockets
- For the simple removal of nuts from 1/4", 3/8", 1/2" sockets with holding function
- Hexagonal anti-roll feature against rolling away

Nut Extractor



	EAN							
Code	4013288	mm	mm					
05050005001	192554	14,0	43,0					1

Belt A 4 Zyklop socket set, 1/4" drive

- 9-piece socket set on a robust textile belt, 1/4"
- For manual and power tool operations (non-impact)
- Smooth Twist to Unlock mechanism for a secure fit and simple removal of the sockets
- Take it easy tool finder with colour coding according to sizes
- Suitable for attachment to a wall, shelf, tool trolley and to the Wera 2go System

Belt A 4 Zyklop socket set, 1/4" drive



Code		EAN		
05003883001		4013288 190789		1
		●	8790 HMA 1x 5,0x23,0; 1x 5,5x23,0; 1x 6,0x23,0; 1x 7,0x23,0; 1x 8,0x23,0; 1x 10,0x23,0; 1x 11,0x23,0; 1x 12,0x23,0; 1x 13,0x23,0	
			Belt A 0/9 1x 39,0x238,0	
			K30 1x 30,0x200,0	

Magnetic socket rail A 4 Zyklop socket set, 1/4" drive

Socket rail with 9 manual and machine sockets (non-impact), 1/4". A smooth rotary mechanism allows a secure hold and easy access of the sockets.

With Take it easy tool finder with colour coding by size - to help you find the required tool quickly and easily.

The rail allows temporary attachment to metallic surfaces and, with its twist-to-unlock function, ensures secure locking and unlocking of the sockets.

- 9-piece socket set on socket rail, 1/4"
- Rail with secure bit mounting and yet easy removal (twist-to-unlock) for temporary attachment on wall, shelf or workshop trolley
- Smooth Twist to Unlock mechanism for a secure fit and simple removal of the sockets
- With Take it easy tool finder: colour coding by size

Magnetic socket rail A 4 Zyklop socket set, 1/4" drive



Code	EAN		
05005400001	4013288 223197		1
		● 8790 HMA 1x 5,0x23,0; 1x 5,5x23,0; 1x 6,0x23,0; 1x 7,0x23,0; 1x 8,0x23,0; 1x 10,0x23,0; 1x 11,0x23,0; 1x 12,0x23,0; 1x 13,0x23,0	
		9600 1x 30,0x270,0	

Belt A Imperial 1 Zyklop In-Hex-Plus bit socket set with holding function, 1/4" drive



Code	EAN		
05003884001	4013288 194992		1
		● 8740 A 1x 5/64"x28,0; 1x 3/32"x28,0; 1x 7/64"x28,0	
		● 8740 A HF 1x 1/8"x28,0; 1x 9/64"x28,0; 1x 5/32"x28,0; 1x 3/16"x28,0; 1x 7/32"x28,0; 1x 1/4"x28,0	
		Belt A 0/9 1x 39,0x238,0	
		K30 1x 30,0x200,0	

Magnetic socket rail A Imperial 1 Zyklop socket set, 1/4" drive, imperial

Socket rail with 9 manual and machine sockets (non-impact), 1/4". A smooth rotary mechanism allows a secure hold and easy access of the sockets.

With Take it easy tool finder with colour coding by size - to help you find the required tool quickly and easily.

The rail allows temporary attachment to metallic surfaces and, with its twist-to-unlock function, ensures secure locking and unlocking of the sockets.

- 9-piece socket set on socket rail, 1/4"
- Rail with secure bit mounting and yet easy removal (twist-to-unlock) for temporary attachment on wall, shelf or workshop trolley
- Smooth Twist to Unlock mechanism for a secure fit and simple removal of the sockets
- With Take it easy tool finder: colour coding by size

Magnetic socket rail A Imperial 1 Zyklop socket set, 1/4" drive, imperial



Code	EAN		
05005420001	4013288 223227		1
		● 8790 HMA 1x 3/16"x23,0; 1x 7/32"x23,0; 1x 1/4"x23,0; 1x 9/32"x23,0; 1x 5/16"x23,0; 1x 11/32"x23,0; 1x 3/8"x23,0; 1x 7/16"x23,0; 1x 1/2"x23,0	
		9600 1x 30,0x270,0	

8790 HMA Deep 1/4" socket

Long 1/4" hand and machine socket (ISO 2725 part 3) with ball intercept ring; for external hexagonal bolts and sockets.

For use in manual and machine operation (non-impact), even with low-lying screwdriving and protruding threaded rods.

With Take it easy tool finder with colour coding by size - for easy and fast location of the required tool. Easy to grasp even with oily hands.

The hexagon profile allows the transmission of high forces and puts less strain on the edges of bolts or screw heads than a double hexagon profile.

Fine-toothed ratchets also make the use of a double hexagon profile superfluous, even in confined spaces, thanks to their small back-pivoting angle.

- Long sockets for low-lying screwdriving, often even with protruding threaded rods in small spaces
- Hexagonal profile enables precise bolting with high power transmission and preserves the profile
- Take it easy tool finder with colour coding according to sizes
- Knurling on lower end for more grip when used manually
- For manual and machine operation (non-impact), ball intercept ring
- Made of matt chromed chrome-vanadium

8790 HMA Deep 1/4" socket



Code	EAN	mm	mm	mm	mm	
05004500001	210258	4,0	50,0	6,7	11,8	1
05004501001	210128	5,0	50,0	8,0	11,8	1
05004502001	210241	5,5	50,0	8,6	11,8	1
05004503001	210265	6,0	50,0	9,2	11,8	1
05004504001	210272	7,0	50,0	10,8	11,8	1
05004505001	210289	8,0	50,0	11,8	11,0	1
05004506001	210296	9,0	50,0	12,8	12,0	1
05004507001	210302	10,0	50,0	14,7	12,8	1
05004508001	210319	11,0	50,0	15,8	14,0	1
05004509001	210326	12,0	50,0	16,8	15,0	1
05004510001	210333	13,0	50,0	17,8	16,0	1
05004511001	210340	14,0	50,0	19,8	17,0	1
05004512001	210357	15,0	50,0	20,8	18,0	1

Belt A Deep 1 socket set, 1/4" drive

Robust textile belt in the typical Wera design with 9 long 1/4" manual and machine socket inserts (non-impacting) in a confined space. A smoother turning mechanism ensures a secure holding and easy removal of sockets. Includes snap hook for attaching to belt loops or bags.

With fleece backing and hook and loop fastener strips for easy attachment e.g. on wall, shelf, workshop trolley or the Wera 2go tool transport system.

Long 1/4" manual and mechanical socket wrench inserts (ISO 2725 part 3) from Wera for use in manual and machine operation (non-impacting) even with low-lying screwdriving and protruding threaded rods.

With Take it easy tool finder with colour coding by size - for easy and fast location of the required tool. Easy to grasp even with oily hands. With hexagonal profile and ball-catching groove. The hexagon profile allows the transmission of high forces and puts less strain on the edges of bolts or screw heads than a double hexagon profile.

Fine-toothed ratchets also make the use of a double hexagon profile superfluous, even in confined spaces, thanks to their small back-pivoting angle. For external hexagonal bolts and sockets.

- 9-piece socket set on a robust textile belt, 1/4"
- Smooth Twist to Unlock mechanism for a secure fit and simple removal of the sockets
- Long 1/4" socket for low-profile-fitting screw connections in tight construction spaces and for protruding threaded rods
- Hexagonal profile enables precise and profile-preserving screw-driving with high power transmission
- Take it easy tool finder with colour coding according to sizes

Belt A Deep 1 socket set, 1/4" drive



Code	EAN		
05004525001	210371		1
		8790 HMA Deep 1x 5,0x50,0; 1x 5,5x50,0; 1x 6,0x50,0; 1x 7,0x50,0; 1x 8,0x50,0; 1x 10,0x50,0; 1x 11,0x50,0; 1x 12,0x50,0; 1x 13,0x50,0	
		Belt A 0/9 1x 39,0x238,0	
		K30 1x 30,0x200,0	

Magnetic socket rail A Deep 1 socket set, 1/4" drive

Socket rail with 9 long manual and machine sockets (non-impact), 1/4". A smooth rotary mechanism allows a secure hold and easy access of the sockets.

Long 1/4" manual and machine sockets (ISO 2725 part 3) by Wera for manual and (non-impact) machine use even at low lying couplings and protruding thread rods. With Take it easy tool finder with colour coding by size - to help you find the required tool quickly and easily.

Slip-proof for easy grip even with oily hands. With hexagon profile and ball stop groove.

The hexagon profile enables the transmission of high forces and loads the edges of the bolt or the screw head less than a double hexagon profile.

Fine-teethed ratchets also make use of a double hexagon profile superfluous, even in confined spaces, thanks to their small return angle.

For external hexagon bolts and screws. The rail allows temporary attachment to metallic surfaces and, with its twist-to-unlock function, ensures secure locking and unlocking of the sockets.

- 9-piece socket set on socket rail, 1/4"
- Rail with secure bit mounting and yet easy removal (twist-to-unlock) for temporary attachment on wall, shelf or workshop trolley
- Smooth Twist to Unlock mechanism for a secure fit and simple removal of the sockets
- Long 1/4" socket for low-profile-fitting screw connections in tight construction spaces and for protruding threaded rods
- Hexagonal profile enables precise and profile-preserving screwdriving with high power transmission

Magnetic socket rail A Deep 1 socket set, 1/4" drive



Code	EAN			
05005410001	223210			1
		8790 HMA Deep 1x 5,0x50,0; 1x 5,5x50,0; 1x 6,0x50,0; 1x 7,0x50,0; 1x 8,0x50,0; 1x 10,0x50,0; 1x 11,0x50,0; 1x 12,0x50,0; 1x 13,0x50,0		
		9600 1x 30,0x270,0		

8767 A TORX® Zyklop bit socket with holding function, 1/4" drive



	EAN							
Code	4013288			mm	mm	mm	mm	
05003390001	219602		TX 10	28,0	12,0	12,5	11,0	1
05003391001	219619		TX 20	28,0	12,0	12,5	11,0	1
05003392001	219626		TX 25	28,0	12,0	12,5	11,0	1
05003393001	219633		TX 30	28,0	12,0	12,5	11,0	1

8767 A HF TORX® Zyklop bit socket with holding function, 1/4" drive

- Bit socket (non-impact) for manual or machine tool operations
- The holding function holds screws securely on the tool
- Take it easy tool finder with colour coding according to sizes
- Knurling on lower end for more grip when used manually
- Chrome vanadium steel, matt chrome-plated

8767 A HF TORX® Zyklop bit socket with holding function, 1/4" drive



	EAN							
Code	4013288			mm	mm	mm	mm	
05003360001	186829		TX 8	28,0	12,0	12,5	11,0	1
05003361001	186843		TX 9	28,0	12,0	12,5	11,0	1
05003362001	186836		TX 10	28,0	12,0	12,5	11,0	1
05003363001	186850		TX 15	28,0	12,0	12,5	11,0	1
05003364001	186867		TX 20	28,0	12,0	12,5	11,0	1
05003365001	186874		TX 25	28,0	12,0	12,5	11,0	1
05003366001	186881		TX 25	100,0	12,0	12,5	83,0	1
05003367001	186898		TX 27	28,0	12,0	12,5	11,0	1
05003368001	186904		TX 27	100,0	12,0	12,5	83,0	1
05003369001	186911		TX 30	28,0	12,0	12,5	11,0	1
05003370001	186928		TX 30	100,0	12,0	12,5	83,0	1
05003371001	186935		TX 40	28,0	12,0	12,5	11,0	1
05003372001	186942		TX 40	100,0	12,0	12,5	83,0	1

Belt A 3 TORX® HF Zyklop bit socket set with holding function, 1/4" drive

Typically Wera designed robust textile belt with 9 sockets taking up minimal space. A smooth Twist to Unlock mechanism ensures a secure fit and simple removal of the sockets.

Comes with Take it easy Tool Finder with colour coding according to size to enable the right tool to be selected easily and quickly. Includes a snap hook for secure fastening to a belt loop or pocket. Especially short, stable bit-sockets with all the advantages of the Wera bit technology.

Bit sockets with holding function for particularly convenient screwdriving with reduced risk of losing the screw when approaching the workpiece. Supplied with a nonwoven reverse side and hook and loop strips for simple attachment e.g. to a wall, shelf, tool trolley and to the Wera 2go tool transport system.

- 9-piece bit-socket set on a robust textile belt, 1/4"
- Bit-sockets with all the advantages of the Wera bit technology
- Bit-sockets with holding function for screws/bolts
- Smooth Twist to Unlock mechanism for a secure fit and simple removal of the sockets
- Suitable for attachment to a wall, shelf, tool trolley and to the Wera 2go System
- Take it easy tool finder with colour coding according to sizes

Belt A 3 TORX® HF Zyklop bit socket set with holding function, 1/4" drive



Code	EAN		
05003882001	190772		1
		8767 A HF 1x TX 8x28,0; 1x TX 9x28,0; 1x TX 10x28,0; 1x TX 15x28,0; 1x 3,7x3,7xTX 20x28,0; 1x 4,1x4,1xTX 25x28,0; 1x 4,8x4,8xTX 27x28,0; 1x 5,4x5,4xTX 30x28,0; 1x 6,5x6,5xTX 40x28,0	
		Belt A 0/9 1x 39,0x238,0	
		K30 1x 30,0x200,0	

8767 A TORX® HF 1 Zyklop bit socket set with holding function, 1/4" drive

- Compact textile box with high robustness, low weight and volume
- Bit socket (non-impact) for manual or power tool operations
- The holding function holds screws securely on the tool
- Take it easy tool finder with colour coding according to sizes
- Knurling on lower socket end for more grip when used manually
- Long design

8767 A TORX® HF 1 Zyklop bit socket set with holding function, 1/4" drive



Code	EAN		
05003375001	191014		1
		8767 A HF 1x TX 25x100,0; 1x TX 27x100,0; 1x TX 30x100,0; 1x TX 40x100,0	
		K70 1x 50,0x70,0	



8740 A HF Zyklop bit socket with holding function, 1/4" drive

- Bit socket (non-impact) for manual or machine tool operations
- The holding function holds screws securely on the tool
- Hex-Plus allows socket head screws to live longer

8740 A HF Zyklop bit socket with holding function, 1/4" drive



Code	EAN	mm	mm	mm	mm	mm	
05003332001	187123	3,0	28,0	12,0	12,5	1	
05003333001	187178	4,0	28,0	12,0	12,5	1	
05003334001	187185	4,0	100,0	12,0	12,5	1	
05003335001	187192	5,0	28,0	12,0	12,5	1	
05003336001	187208	5,0	100,0	12,0	12,5	1	
05003337001	187215	6,0	28,0	12,0	12,5	1	
05003338001	187222	6,0	100,0	12,0	12,5	1	
05003341001	189547	7,0	28,0	12,0	12,5	1	
05003342001	189554	7,0	100,0	12,0	12,5	1	
05003339001	187239	8,0	28,0	12,0	12,5	1	
05003340001	187246	8,0	100,0	12,0	12,5	1	
05003383001	189868		1/8"	28,0	12,0	12,5	1
05003384001	189875		9/64"	28,0	12,0	12,5	1
05003385001	189882		5/32"	28,0	12,0	12,5	1
05003386001	189899		3/16"	28,0	12,0	12,5	1
05003387001	189905		7/32"	28,0	12,0	12,5	1
05003388001	189912		1/4"	28,0	12,0	12,5	1
05003389001	189844		5/16"	28,0	12,0	12,5	1

8740 A Zyklop bit socket, 1/4" drive

- Bit socket (non-impact) for manual or machine tool operations
- Hex-Plus allows socket head screws to live longer

8740 A Zyklop bit socket, 1/4" drive



Code	EAN	mm	mm	mm	mm	mm	
05003330001	187154	2,0	28,0	12,0	12,5	1	
05003331001	187161	2,5	28,0	12,0	12,5	1	
05003380001	189820		5/64"	28,0	12,0	12,5	1
05003381001	189837		3/32"	28,0	12,0	12,5	1
05003382001	189851		7/64"	28,0	12,0	12,5	1

Belt A 2 Zyklop In-Hex-Plus bit socket set with holding function, 1/4" drive

Typically Wera designed robust textile belt with 8 in-hex bit-sockets taking up minimal space.

A smooth Twist to Unlock mechanism ensures a secure fit and simple removal of the sockets.

Comes with Take it easy Tool Finder with colour coding according to size to enable the right tool to be selected easily and quickly. Includes a snap hook for secure fastening to a belt loop or pocket.

Supplied with a nonwoven reverse side and hook and loop strips for simple attachment e.g. to a wall, shelf, tool trolley and to the Wera 2go tool transport system.

- 8-piece bit socket set on a robust textile belt, 1/4"
- Bit-sockets with all the advantages of the Wera bit technology
- Bit sockets with retaining function for hexagon socket screws
- Take it easy tool finder with colour coding according to sizes
- Smooth Twist to Unlock mechanism for a secure fit and simple removal of the sockets
- Suitable for attachment to a wall, shelf, tool trolley and to the Wera 2go System

Belt A 2 Zyklop In-Hex-Plus bit socket set with holding function, 1/4" drive



Code	EAN		
05003881001	190765		1
		<ul style="list-style-type: none"> 8740 A 1x 2,0x28,0; 1x 2,5x28,0 8740 A HF 1x 3,0x28,0; 1x 4,0x28,0; 1x 5,0x28,0; 1x 6,0x28,0; 1x 7,0x28,0; 1x 8,0x28,0 Belt A 0/8 1x 39,0x220,0 K30 1x 30,0x200,0 	

8740 A HF 1 Zyklop bit socket set with holding function, 1/4" drive

- Compact textile box with high robustness, low weight and volume
- Bit socket (non-impact) for manual or power tool operations
- The holding function holds screws securely on the tool
- Take it easy tool finder with colour coding according to sizes
- Knurling on lower socket end for more grip when used manually
- Long design

8740 A HF 1 Zyklop bit socket set with holding function, 1/4" drive



Code	EAN		
05003345001	191007		1
		8740 A HF 1x 4,0x100,0; 1x 5,0x100,0; 1x 6,0x100,0; 1x 7,0x100,0; 1x 8,0x100,0 K70 1x 50,0x70,0	

8751 A Phillips Zyklop bit socket, 1/4" drive

- Extremely short

8751 A Phillips Zyklop bit socket, 1/4" drive



Code	EAN	+	mm	mm	mm	mm	
05003350001	187253	PH 1	28,0	12,0	11,0	12,5	1
05003351001	187260	PH 2	28,0	12,0	11,0	12,5	1
05003352001	187277	PH 3	28,0	12,0	11,0	12,5	1

8755 A Pozidriv Zyklop bit socket, 1/4" drive

- Extremely short

8755 A Pozidriv Zyklop bit socket, 1/4" drive



Code	EAN	PZ	mm	mm	mm	mm	
05003353001	187284	PZ 1	28,0	12,0	11,0	12,5	1
05003354001	187291	PZ 2	28,0	12,0	11,0	12,5	1
05003355001	187307	PZ 3	28,0	12,0	11,0	12,5	1

8700 A FL Slotted screws Zyklop bit socket, 1/4" drive

- Extremely short

8700 A FL Slotted screws Zyklop bit socket, 1/4" drive



Code	EAN	mm	mm	mm	mm	mm	mm	
05003320001	187314	0,8	5,5	28,0	12,0	11,0	11,0	1
05003321001	187321	1,0	5,5	28,0	12,0	11,0	11,0	1
05003322001	187338	1,2	6,5	28,0	12,0	11,0	11,0	1

8796 LA Zyklop "flexible-lock" extension with free-turning sleeve, long, 1/4"

- For 1/4" square sockets with ball lock
- Flexible lock system for either locking or rapid exchange of the attached tool
- With free-turning sleeve for rapid tightening and loosening of screws and nuts

8796 LA Zyklop "flexible-lock" extension with free-turning sleeve, long, 1/4"



Code	EAN	1/4"	mm				
05003531001	121059	1/4"	150,0				1

8796 SA Zyklop "flexible-lock" extension with free-turning sleeve, short, 1/4"

- For 1/4" square sockets with ball lock
- Flexible lock system for either locking or rapid exchange of the attached tool
- With free-turning sleeve for rapid tightening and loosening of screws and nuts

8796 SA Zyklop "flexible-lock" extension with free-turning sleeve, short, 1/4"



Code	EAN	□	⌀						
05003530001	121042	1/4"	75,0						1

8794 LA Zyklop extension with free-turning sleeve, long, 1/4"

Wera Zyklop extension with easy-to-grip free-turning sleeve for rapid tightening and loosening of screws and nuts. Out of high quality chrome vanadium steel, matt chrome-plated.

8794 LA Zyklop extension with free-turning sleeve, long, 1/4"



Code	EAN	□	⌀						
05003526001	121073	1/4"	150,0						1

8794 SA Zyklop extension with free-turning sleeve, short, 1/4"

Wera Zyklop extension with easy-to-grip free-turning sleeve for rapid tightening and loosening of screws and nuts. Out of high quality chrome vanadium steel, matt chrome-plated.

8794 SA Zyklop extension with free-turning sleeve, short, 1/4"



Code	EAN	□	⌀						
05003525001	121066	1/4"	75,0						1

8789 A Zyklop sliding T-handle, 1/4"

Wera Zyklop T-handle for higher torque transfer. For 1/4" square sockets with ball lock. Adjustable drive, therefore more flexible usage. Out of high quality chrome vanadium steel, matt chrome-plated.

8789 A Zyklop sliding T-handle, 1/4"



Code	EAN	□	⌀						
05003524001	121493	1/4"	110,0						3

8795 A Zyklop universal joint, 1/4"

Wera Zyklop universal joint for 1/4" square sockets with ball lock.

8795 A Zyklop universal joint, 1/4"



Code	EAN	□	⌀						
05003528001	121509	1/4"	35,5						1

8784 A1 Zyklop bit adaptor, 1/4"

- 1/4" Zyklop adaptor with quick-release chuck for rapid bit change

8784 A1 Zyklop bit adaptor, 1/4"



	EAN							
Code	4013288			mm				
05003529001	121035	1/4"	1/4"	37,0				1

8794 A Zyklop wobble extension, 1/4"

Wobble extension for the Wera Zyklop. Swivel angle of 15° in all directions. This ensures rapid and precise work even in confined working situations.

8794 A Zyklop wobble extension, 1/4"



	EAN							
Code	4013288		mm					
05003527001	121080	1/4"	56,0					1

Socket rail A (textile belt), 9 location, unloaded



Code	EAN							
05003891001	192424							1
		Belt A 0/9						
		1x 39,0x238,0						
		K30						
		1x 30,0x200,0						

Socket rail A (textile belt), 8 location, unloaded



Code	EAN						
05003890001	192417						1
		Belt A 0/8					
		1x 39,0x220,0					
		K30					
		1x 30,0x200,0					

9600 Magnetic socket rail, 1/4", empty

1 socket rail, empty. For up to 10 sockets and/or bit sockets with 1/4" drive.

The rail allows temporary attachment to metallic surfaces and, with its twist-to-unlock function, ensures secure locking and unlocking of the sockets.

- Rail with secure bit mounting and yet easy removal (twist-to-unlock) for temporary attachment on wall, shelf or workshop trolley
- Smooth Twist to Unlock mechanism for a secure fit and simple removal of the sockets
- Empty, for up to 10 sockets, 1/4"

9600 Magnetic socket rail, 1/4", empty

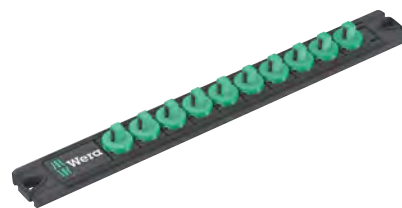

	EAN						
Code	4013288	mm	mm				
05136420001	223326	30,0	270,0				1

Zyklop Speed - incredibly fast and incredibly flexible



Incredibly compact set arrangement with many tools in a minimum of space. A completely new ratchet set feeling thanks to the unique textile boxes that are very robust and durable.

They can be positioned upright for tidy storage on the workshop shelf. Additional surface protection due to textile outer material. Low weight and volume for simpler mobility.

Take it easy Tool Finder with colour coding according to sizes.

- Freely pivoting ratchet head with 5 predefined locking positions
- Fine toothing with 72 teeth
- Small return angle of only 5°
- Free-turning sleeve for high working speeds
- Take it easy tool finder with colour coding according to sizes
- Compact textile box with high robustness, low weight and volume

8100 SB All-in Zyklop Speed ratchet set, 3/8" drive

- Easy removal of the ratchet thanks to Twist-to-unlock system

8100 SB All-in Zyklop Speed ratchet set, 3/8" drive

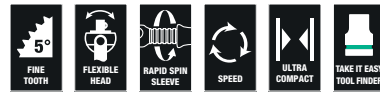

Code	EAN		
05003536001	4013288 225573		1
		8000 B 1x 3/8"x199,0	
		8794 B 1x 3/8"x76,0	
		8796 LB 1x 3/8"x200,0	
		8790 HMB HF 1x 6,0x29,0; 1x 7,0x29,0; 1x 8,0x29,0; 1x 9,0x29,0; 1x 10,0x29,0; 1x 11,0x29,0; 1x 12,0x29,0; 1x 13,0x29,0; 1x 14,0x29,0; 1x 15,0x29,0; 1x 16,0x29,0; 1x 17,0x29,0; 1x 18,0x29,0; 1x 19,0x29,0	
		8767 B HF 1x TX 10x35,0; 1x TX 15x35,0; 1x TX 20x35,0; 1x TX 25x35,0; 1x TX 27x35,0; 1x TX 30x35,0;	
		8740 B HF 1x 3,0x35,0; 1x 4,0x35,0; 1x 5,0x35,0; 1x 6,0x35,0; 1x 7,0x38,5; 1x 8,0x38,5;	
		Nut Extractor 1x 14,0x43,0	
		Hook and Loop Fastener Strip 240 1x 50,0x240,0	

8100 SB 6 Zyklop Speed Ratchet Set, 3/8" drive, metric



Code	EAN			
	4013288			
05004046001	173911			1
		<input type="checkbox"/> 8000 B 1x 3/8"x199,0		
		<input checked="" type="checkbox"/> 8790 HMB 1x 8,0x29,0; 1x 10,0x29,0; 1x 12,0x29,0; 1x 13,0x29,0; 1x 15,0x29,0; 1x 16,0x30,0; 1x 17,0x30,0; 1x 18,0x30,0; 1x 19,0x30,0		
		<input checked="" type="checkbox"/> <input type="checkbox"/> 8794 LB 1x 3/8"x200,0		
		<input checked="" type="checkbox"/> <input type="checkbox"/> 8794 B 1x 3/8"x76,0		
		<input checked="" type="checkbox"/> <input checked="" type="checkbox"/> 8784 B1 1x 1/4"x3/8"x44,0		
		<input checked="" type="checkbox"/> 851/4 TZ PH 1x PH 1x50; 1x PH 2x50; 1x PH 3x50		
		<input checked="" type="checkbox"/> 855/4 TZ PZ 1x PZ 1x50; 1x PZ 2x50; 1x PZ 3x50		
		<input checked="" type="checkbox"/> 867/4 Z TORX® 1x TX 20x50; 1x TX 25x50; 1x TX 27x50; 1x TX 30x50; 1x TX 40x50		
		<input type="checkbox"/> 840/4 Z Hex-Plus 1x 4,0x50; 1x 5,0x50; 1x 6,0x50; 1x 8,0x50		
		<input type="checkbox"/> 800/4 Z 1x 1,0x5,5x50		

8100 SB 9 Zyklop Speed Ratchet Set, 3/8" drive, imperial



Code	EAN			
	4013288			
05004049001	173980			1
		<input type="checkbox"/> 8000 B 1x 3/8"x199,0		
		<input checked="" type="checkbox"/> 8790 HMB 1x 1/4"x29,0; 1x 5/16"x29,0; 1x 3/8"x29,0; 1x 7/16"x29,0; 1x 1/2"x29,0; 1x 9/16"x29,0; 1x 5/8"x30,0; 1x 11/16"x30,0; 1x 3/4"x30,0		
		<input checked="" type="checkbox"/> <input type="checkbox"/> 8794 LB 1x 3/8"x200,0		
		<input checked="" type="checkbox"/> <input type="checkbox"/> 8794 B 1x 3/8"x76,0		
		<input checked="" type="checkbox"/> <input checked="" type="checkbox"/> 8784 B1 1x 1/4"x3/8"x44,0		
		<input checked="" type="checkbox"/> 851/4 TZ PH 1x PH 1x50; 1x PH 2x50; 1x PH 3x50		
		<input checked="" type="checkbox"/> 855/4 TZ PZ 1x PZ 1x50; 1x PZ 2x50; 1x PZ 3x50		
		<input checked="" type="checkbox"/> 867/4 Z TORX® 1x TX 20x50; 1x TX 25x50; 1x TX 27x50; 1x TX 30x50; 1x TX 40x50		
		<input type="checkbox"/> 840/4 Z Hex-Plus 1x 3/16"x50; 1x 7/32"x50; 1x 1/4"x50; 1x 5/16"x50		
		<input type="checkbox"/> 800/4 Z 1x 1,0x5,5x50		

8100 SB 2 Zyklop Speed Ratchet Set, 3/8" drive, metric

- 43-piece set in a robust metal case

8100 SB 2 Zyklop Speed Ratchet Set, 3/8" drive, metric



Code	EAN		
05003594001	4013288 121141		1
		<input type="checkbox"/> 8000 B 1x 3/8"x199,0	
		<input checked="" type="checkbox"/> 8790 HMB 1x 6,0x29,0; 1x 7,0x29,0; 1x 8,0x29,0; 1x 9,0x29,0; 1x 10,0x29,0; 1x 11,0x29,0; 1x 12,0x29,0; 1x 13,0x29,0; 1x 14,0x29,0; 1x 15,0x29,0; 1x 16,0x30,0; 1x 17,0x30,0; 1x 18,0x30,0; 1x 19,0x30,0; 1x 20,0x30,0; 1x 21,0x30,0; 1x 22,0x30,0; 1x 24,0x32,0	
		<input type="checkbox"/> 8789 B 1x 3/8"x165,0	
		<input checked="" type="checkbox"/> 8794 B 1x 3/8"x76,0	
		<input checked="" type="checkbox"/> 8795 B 1x 3/8"x50,0	
		<input checked="" type="checkbox"/> 8784 B1 1x 1/4"x3/8"x44,0	
		<input checked="" type="checkbox"/> 8796 SB 1x 3/8"x125,0	
		<input checked="" type="checkbox"/> 8796 LB 1x 3/8"x200,0	
		<input checked="" type="checkbox"/> 851/1 Z PH 1x PH 2x25; 1x PH 3x25	
		<input checked="" type="checkbox"/> 855/1 Z PZ 1x PZ 2x25; 1x PZ 3x25	
		<input checked="" type="checkbox"/> 867/1 Z TORX® B0 1x TX 10x25; 1x TX 15x25; 1x TX 20x25; 1x TX 25x25; 1x TX 27x25; 1x TX 30x25; 1x TX 40x25	
		<input type="checkbox"/> 840/1 Z Hex-Plus 1x 3,0x25; 1x 4,0x25; 1x 5,0x25; 1x 6,0x25; 1x 8,0x25; 1x 10,0x25	
		<input type="checkbox"/> 800/1 Z 1x 1,0x5,5x25	

8100 SB 4 Zyklop Speed Ratchet Set, 3/8" drive, imperial

- 38-piece set in a robust metal case

8100 SB 4 Zyklop Speed Ratchet Set, 3/8" drive, imperial



Code	EAN		
05003596001	4013288 121165		1
		<input type="checkbox"/> 8000 B 1x 3/8"x199,0	
		<input checked="" type="checkbox"/> 8790 HMB 1x 1/4"x29,0; 1x 5/16"x29,0; 1x 11/32"x29,0; 1x 3/8"x29,0; 1x 7/16"x29,0; 1x 1/2"x29,0; 1x 9/16"x29,0; 1x 5/8"x30,0; 1x 11/16"x30,0; 1x 3/4"x30,0; 1x 13/16"x30,0; 1x 7/8"x30,0	
		<input type="checkbox"/> 8789 B 1x 3/8"x165,0	
		<input checked="" type="checkbox"/> 8794 B 1x 3/8"x76,0	
		<input checked="" type="checkbox"/> 8795 B 1x 3/8"x50,0	
		<input checked="" type="checkbox"/> 8784 B1 1x 1/4"x3/8"x44,0	
		<input checked="" type="checkbox"/> 8796 SB 1x 3/8"x125,0	
		<input checked="" type="checkbox"/> 8796 LB 1x 3/8"x200,0	
		<input checked="" type="checkbox"/> 851/1 Z PH 1x PH 2x25; 1x PH 3x25	
		<input checked="" type="checkbox"/> 855/1 Z PZ 1x PZ 2x25; 1x PZ 3x25	
		<input checked="" type="checkbox"/> 867/1 Z TORX® B0 1x TX 10x25; 1x TX 15x25; 1x TX 20x25; 1x TX 25x25; 1x TX 27x25; 1x TX 30x25; 1x TX 40x25	
		<input type="checkbox"/> 800/1 Z 1x 1,0x5,5x25	
		<input type="checkbox"/> 840/1 Z Hex-Plus 1x 3/64"x25; 1x 3/32"x25; 1x 1/8"x25; 1x 9/64"x25; 1x 5/32"x25; 1x 3/16"x25; 1x 7/32"x25	

Zyklop Speed - incredibly fast and incredibly flexible



27-piece $\frac{3}{8}$ " ratchet set for typical bicycle operations with extensive accessories:

1 Zyklop Speed ratchet with $\frac{3}{8}$ " drive, 10 Zyklop sockets, 2 Zyklop bit sockets with 30mm and extra slim profile area for better accessibility in tight workspaces.

With Take it easy tool finder: Colour coding by size. 1 Zyklop extension (short) with fast-rotating sleeve, 1 Wobble extension, 1 bit adapter, 1 connection part $\frac{3}{8}$ " external square head to $\frac{1}{2}$ " external square head, 10 bits, tough, for universal use.

Incredibly compact set arrangement for many tools in a tight space thanks to the highly robust and durable textile box.

Can be placed in an upright position for clearly arranged storage in the workshop shelf. Additional surface protection due to textile outer material. Low weight and small size for better mobility.

- 27-piece $\frac{3}{8}$ " ratchet set including fine-toothed Zyklop Speed ratchet with swivelling ratchet head, push-button release and right/left switching
- Low return angle of only 5° for working in a small space
- Sockets and bits for the most popular screw profiles for road bikes, mountain bikes and e-bikes
- Assortment in robust textile box with low weight for easy transport
- With adapter from $\frac{3}{8}$ " square head socket to $\frac{1}{2}$ " external square head for mounting special bicycle tools

Bicycle set 7



Code	EAN		
05004175001	4013288 220608		1
		8000 B 1x $\frac{3}{8}$ "x199,0	
		8790 HMB 1x 6,0x29,0; 1x 7,0x29,0; 1x 8,0x29,0; 1x 9,0x29,0; 1x 10,0x29,0; 1x 11,0x29,0; 1x 12,0x29,0; 1x 13,0x29,0; 1x 14,0x29,0	
		8790 HMB Deep 1x 15,0x64,0	
		8740 B 1x 8,0x100,0; 1x 10,0x100,0	
		8794 B 1x $\frac{3}{8}$ "x76,0	
		8784 B1 1x $\frac{1}{4}$ "x $\frac{3}{8}$ "x44,0	
		8794 SB 1x $\frac{3}{8}$ "x125,0	
		781 B 1x 781 B/C, $\frac{1}{2}$ "x36,0x $\frac{3}{8}$ "	
		840/4 Z Hex-Plus 1x 3,0x50; 1x 4,0x50; 1x 5,0x50; 1x 6,0x50	
		867/4 Z TORX® 1x TX 10x50; 1x TX 15x50; 1x TX 20x50; 1x TX 25x50; 1x TX 27x50; 1x TX 30x50	

8000 B Zyklop Speed Ratchet with $\frac{3}{8}$ " drive

- Combines five different types of a ratchet in one
- Flywheel design and easy-to-grip free-turning sleeve for very high working speeds
- Freely pivoting ratchet head, push button release and left/right switchover
- Fine-tooth design allows a small return angle of 5°
- Can also be used as a screwdriver

8000 B Zyklop Speed Ratchet with $\frac{3}{8}$ " drive



Code	EAN					
05003550001	4013288 121875	$\frac{3}{8}$ "	199,0	mm		1

8000 B SB Zyklop Speed Ratchet with 3/8" drive



	Code	EAN 4013288		
	05073261001	128041	8000 B 1x 3/8"x199.0	3

Zyklop Metal with push-through square

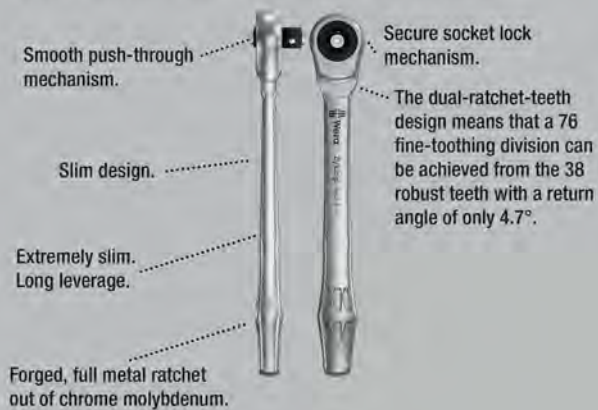

Incredibly compact set arrangement with many tools in a minimum of space. A completely new ratchet set feeling thanks to the unique textile boxes that are very robust and durable.

They can be positioned upright for tidy storage on the workshop shelf. Additional surface protection due to textile outer material. Low weight and volume for simpler mobility. Take it easy Tool Finder with colour coding according to sizes.

- Extremely slim ratchet with long lever
- Return angle of only 4.7°
- Absolutely smooth switchover of the non-detachable push-through square

8100 SB 7 Zyklop Metal Ratchet Set with push-through square, 3/8" drive, metric



	Code	EAN 4013288		
	05004047001	173867		1
			8003 B 1x 3/8"x222,0	
			8790 HMB 1x 8,0x29,0; 1x 10,0x29,0; 1x 12,0x29,0; 1x 13,0x29,0; 1x 15,0x29,0; 1x 16,0x30,0; 1x 17,0x30,0; 1x 18,0x30,0; 1x 19,0x30,0	
			8794 LB 1x 3/8"x200,0	
			8794 B 1x 3/8"x76,0	
			8784 B1 1x 1/4"x3/8"x44,0	
			851/1 Z PH 1x PH 1x25; 1x PH 2x25; 1x PH 3x25	
			855/1 Z PZ 1x PZ 1x25; 1x PZ 2x25	
			867/1 TORX® 1x TX 15x25; 1x TX 20x25; 1x TX 25x25; 1x TX 27x25; 1x TX 30x25; 1x TX 40x25	
			840/1 Z Hex-Plus 1x 3,0x25; 1x 4,0x25; 1x 5,0x25; 1x 6,0x25; 1x 8,0x25	

8100 SB 10 Zyklop Metal Ratchet Set with push-through square, 3/8" drive, imperial



Code	EAN			
05004050001	4013288 173935			1
		<input type="checkbox"/>	8003 B 1x 3/8"x222,0	
		<input checked="" type="checkbox"/>	8790 HMB 1x 1/4"x29,0; 1x 5/16"x29,0; 1x 3/8"x29,0; 1x 7/16"x29,0; 1x 1/2"x29,0; 1x 9/16"x29,0; 1x 5/8"x30,0; 1x 11/16"x30,0; 1x 3/4"x30,0	
		<input checked="" type="checkbox"/>	8794 LB 1x 3/8"x200,0	
		<input checked="" type="checkbox"/>	8794 B 1x 3/8"x76,0	
		<input checked="" type="checkbox"/>	8784 B1 1x 1/4"x3/8"x44,0	
		<input checked="" type="checkbox"/>	851/1 Z PH 1x PH 1x25; 1x PH 2x25; 1x PH 3x25	
		<input checked="" type="checkbox"/>	855/1 Z PZ 1x PZ 1x25; 1x PZ 2x25	
		<input checked="" type="checkbox"/>	867/1 TORX® 1x TX 15x25; 1x TX 20x25; 1x TX 25x25; 1x TX 27x25; 1x TX 30x25; 1x TX 40x25	
		<input checked="" type="checkbox"/>	840/1 Z Hex-Plus 1x 5/32"x25; 1x 3/16"x25; 1x 7/32"x25; 1x 1/4"x25; 1x 5/16"x25	

8003 B Zyklop Metal Ratchet with push-through square and 3/8" drive

- Forged, full metal ratchet (chrome-molybdenum); slim design to enable work in very confined spaces.
- The dual-ratchet-teeth design means that a 76 fine-toothing division can be achieved from the 38 robust teeth with a return angle of only 4.7°.
- Absolutely smooth switchover of the non-detachable push-through square
- For 3/8" square sockets with ball lock

8003 B Zyklop Metal Ratchet with push-through square and 3/8" drive



Code	EAN							
05004033001	4013288 174031	<input type="checkbox"/>	mm	mm	mm			3
		3/8"	222,0	27	29			

Zyklop Metal with switch lever

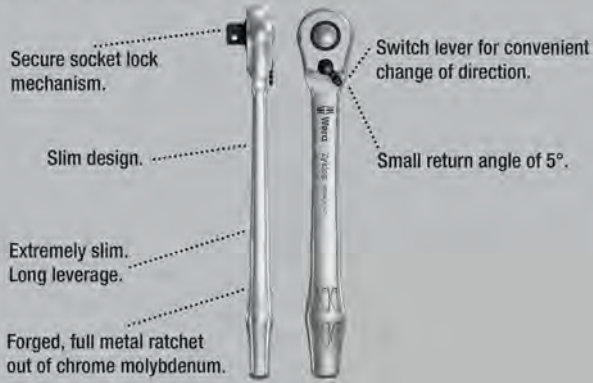

Incredibly compact set arrangement with many tools in a minimum of space. A completely new ratchet set feeling thanks to the unique textile boxes that are very robust and durable.

They can be positioned upright for tidy storage on the workshop shelf. Additional surface protection due to textile outer material. Low weight and volume for simpler mobility. Take it easy Tool Finder with colour coding according to sizes.

- Convenient direction change thanks to switchover lever
- Extremely slim ratchet with long lever
- Return angle of only 5°
- Compact textile box with high robustness, low weight and volume

8100 SB 8 Zyklop Metal Ratchet Set with switch lever, 3/8" drive, metric



Code	EAN		
	4013288		
05004048001	173928		1
		<input type="checkbox"/> 8004 B 1x 3/8"x222,0	
		<input checked="" type="checkbox"/> 8790 HMB 1x 8,0x29,0; 1x 10,0x29,0; 1x 12,0x29,0; 1x 13,0x29,0; 1x 15,0x29,0; 1x 16,0x30,0; 1x 17,0x30,0; 1x 18,0x30,0; 1x 19,0x30,0	
		<input checked="" type="checkbox"/> <input type="checkbox"/> 8794 LB 1x 3/8"x200,0	
		<input checked="" type="checkbox"/> <input type="checkbox"/> 8794 B 1x 3/8"x76,0	
		<input checked="" type="checkbox"/> <input checked="" type="checkbox"/> 8784 B1 1x 1/4"x3/8"x44,0	
		<input checked="" type="checkbox"/> 851/1 Z PH 1x PH 1x25; 1x PH 2x25; 1x PH 3x25	
		<input checked="" type="checkbox"/> 855/1 Z PZ 1x PZ 1x25; 1x PZ 2x25	
		<input checked="" type="checkbox"/> 867/1 TORX® 1x TX 15x25; 1x TX 20x25; 1x TX 25x25; 1x TX 27x25; 1x TX 30x25; 1x TX 40x25	
		<input type="checkbox"/> 840/1 Z Hex-Plus 1x 3,0x25; 1x 4,0x25; 1x 5,0x25; 1x 6,0x25; 1x 8,0x25	

8100 SB 11 Zyklop Metal Ratchet Set with switch lever, 3/8" drive, imperial



Code	EAN			
05004051001	4013288 173959			1
		8004 B	1x 3/8"x222,0	
		8790 HMB	1x 1/4"x29,0; 1x 5/16"x29,0; 1x 3/8"x29,0; 1x 7/16"x29,0; 1x 1/2"x29,0; 1x 9/16"x29,0; 1x 5/8"x30,0; 1x 11/16"x30,0; 1x 3/4"x30,0	
		8794 LB	1x 3/8"x200,0	
		8794 B	1x 3/8"x76,0	
		8784 B1	1x 1/4"x3/8"x44,0	
		851/1 Z PH	1x PH 1x25; 1x PH 2x25; 1x PH 3x25	
		855/1 Z PZ	1x PZ 1x25; 1x PZ 2x25	
		867/1 TORX®	1x TX 15x25; 1x TX 20x25; 1x TX 25x25; 1x TX 27x25; 1x TX 30x25; 1x TX 40x25	
		840/1 Z Hex-Plus	1x 5/32"x25; 1x 3/16"x25; 1x 7/32"x25; 1x 1/4"x25; 1x 5/16"x25	

8100 SB HF 1 Zyklop Metal Ratchet Set with switch lever, 3/8" drive, with holding function, metric

- Colour coding of the sockets according to size

8100 SB HF 1 Zyklop Metal Ratchet Set with switch lever, 3/8" drive, with holding function, metric



Code	EAN			
05003785001	4013288 195081			1
		8004 B	1x 3/8"x222,0	
		8790 HMB HF	1x 8,0x29,0; 1x 10,0x29,0; 1x 12,0x29,0; 1x 13,0x29,0; 1x 15,0x29,0; 1x 16,0x29,0; 1x 17,0x29,0; 1x 18,0x29,0; 1x 19,0x29,0	
		8794 LB	1x 3/8"x200,0	
		8794 B	1x 3/8"x76,0	
		ME1	1x 14,0x43,0	

The Zyklop Metal Ratchets Switch, 3/8"

- Convenient direction change thanks to switchover lever
- Extremely slim ratchet with long lever
- Return angle of only 5°
- Secure socket locking

8004 B Zyklop Metal Ratchet with switch lever and 3/8" drive

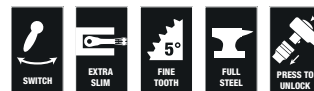

Code	EAN						
05004034001	4013288 174048	3/8"	mm	mm	mm		3
			222,0	26	29		

8790 HMB Zyklop 3/8" socket

- 3/8" Zyklop socket
- For manual and power tool operations (non-impact)
- Knurling at lower end to enable easy gripping when used in manual applications
- Take it easy tool finder with colour coding according to sizes

8790 HMB Zyklop 3/8" socket



Code	EAN							
Code	4013288		mm		mm	mm	mm	
05003551001	120311		6,0		29,0	10,5	18,0	1
05003552001	120328		7,0		29,0	11,0	18,0	1
05003553001	120335		8,0		29,0	12,2	18,0	1
05003554001	120342		9,0		29,0	13,5	18,0	1
05003555001	120359		10,0		29,0	14,5	18,0	1
05003556001	120366		11,0		29,0	16,0	18,0	1
05003557001	120373		12,0		29,0	17,0	18,0	1
05003558001	120380		13,0		29,0	18,5	20,0	1
05003559001	120397		14,0		29,0	19,5	22,0	1
05003560001	120403		15,0		29,0	21,0	24,0	1
05003561001	120410		16,0		30,0	22,0	24,0	1
05003562001	120427		17,0		30,0	23,5	24,0	1
05003563001	120434		18,0		30,0	24,5	24,0	1
05003564001	120441		19,0		30,0	26,0	24,0	1
05003565001	120458		20,0		30,0	28,0	25,0	1
05003566001	120465		21,0		30,0	28,0	25,0	1
05003567001	120472		22,0		30,0	32,0	25,0	1
05003568001	120489		24,0		32,0	32,0	25,0	1
05003569001	120496			1/4"	29,0	11,0	18,0	1
05003570001	120502			5/16"	29,0	12,2	18,0	1
05003571001	120519			11/32"	29,0	13,5	18,0	1
05003572001	120526			3/8"	29,0	14,5	18,0	1
05003573001	120533			7/16"	29,0	16,0	18,0	1
05003574001	120649			1/2"	29,0	18,5	20,0	1
05003575001	120557			9/16"	29,0	19,5	22,0	1
05003576001	120564			5/8"	30,0	22,0	24,0	1
05003577001	120571			11/16"	30,0	23,0	24,0	1
05003578001	120588			3/4"	30,0	26,0	24,0	1
05003579001	120595			13/16"	30,0	28,0	25,0	1
05003580001	120601			7/8"	30,0	32,0	25,0	1

8790 HMB HF Zyklop socket with 3/8" drive with holding function

- Socket (non-impact) for manual or power tool operations
- The holding function holds screws securely on the tool
- Take it easy tool finder with colour coding according to sizes
- Chrome vanadium steel, matt chrome-plated
- Equipped with ball stop groove, knurling at lower end for better gripping

8790 HMB HF Zyklop socket with 3/8" drive with holding function



Code	EAN							
Code	4013288		mm	mm	mm	mm	mm	
05003740001	193919		6,0	29,0	12,7	17,5	6,5	1
05003741001	193926		7,0	29,0	13,2	17,5	6,5	1
05003742001	193933		8,0	29,0	14,2	17,5	6,5	1
05003743001	193940		9,0	29,0	15,7	17,5	6,5	1
05003744001	193957		10,0	29,0	17,0	17,5	8,0	1
05003745001	193964		11,0	29,0	18,2	17,5	9,5	1
05003746001	193971		12,0	29,0	19,0	17,5	9,5	1
05003747001	193988		13,0	29,0	20,4	19,5	9,5	1
05003748001	193995		14,0	29,0	21,5	21,5	12,5	1
05003749001	194008		15,0	29,0	23,5	23,5	12,5	1
05003750001	194015		16,0	29,0	24,2	23,5	12,5	1
05003751001	194022		17,0	29,0	26,0	23,5	12,5	1
05003752001	194039		18,0	29,0	26,5	23,5	12,5	1
05003753001	194046		19,0	29,0	28,0	23,5	12,5	1

Belt B 1 Zyklop socket set with holding function, 3/8" drive

Typically Wera designed robust textile belt with 9 sockets taking up minimal space. A smooth Twist to Unlock mechanism ensures a secure fit and simple removal of the sockets. Comes with Take it easy Tool Finder with colour coding according to size to enable the right tool to be selected easily and quickly. Includes a snap hook for secure fastening to a belt loop or pocket.

Sockets with holding function for particularly convenient screw-driving with reduced risk of losing the screw when approaching the workpiece. Supplied with a non-woven reverse side and hook and loop strips for simple attachment e.g. to a wall, shelf, tool trolley and to the Wera 2go tool transport system.

- 10-piece socket set on a robust textile belt, 1/4"
- Sockets with holding function for screws/bolts/nuts
- Smooth Twist to Unlock mechanism for a secure fit and simple removal of the sockets
- Take it easy tool finder with colour coding according to sizes
- Suitable for attachment to a wall, shelf, tool trolley and to the Wera 2go System

Belt B 1 Zyklop socket set with holding function, 3/8" drive



Code	EAN		
05003970001	194947		1
		● 8790 HMB HF 1x 8,0x29,0; 1x 10,0x29,0; 1x 12,0x29,0; 1x 13,0x29,0; 1x 15,0x29,0; 1x 16,0x29,0; 1x 17,0x29,0; 1x 18,0x29,0; 1x 19,0x29,0	
		ME1 1x 14,0x43,0	
		Belt B 0/9 1x 45,0x310,0	
		K30 1x 30,0x200,0	

Belt B 4 Zyklop socket set, 3/8" drive

- 9-piece socket set on a robust textile belt, 3/8"
- For manual and power tool operations (non-impact)
- Smooth Twist to Unlock mechanism for a secure fit and simple removal of the sockets
- Take it easy tool finder with colour coding according to sizes
- Suitable for attachment to a wall, shelf, tool trolley and to the Wera 2go System

Belt B 4 Zyklop socket set, 3/8" drive



Code	EAN		
05003973001	194978		1
		● 8790 HMB 1x 8,0x29,0; 1x 10,0x29,0; 1x 12,0x29,0; 1x 13,0x29,0; 1x 15,0x29,0; 1x 16,0x30,0; 1x 17,0x30,0; 1x 18,0x30,0; 1x 19,0x30,0	
		Belt B 0/9 1x 45,0x310,0	
		K30 1x 30,0x200,0	



Magnetic socket rail B 4 Zyklop socket set, 3/8" drive

Socket rail with 9 manual and machine sockets (non-impact), 3/8". A smooth rotary mechanism allows a secure hold and easy access of the sockets.

With Take it easy tool finder with colour coding by size - to help you find the required tool quickly and easily.

The rail allows temporary attachment to metallic surfaces and, with its twist-to-unlock function, ensures secure locking and unlocking of the sockets.

- 9-piece socket set on socket rail, 3/8"
- Rail with secure bit mounting and yet easy removal (twist-to-unlock) for temporary attachment on wall, shelf or workshop trolley
- Smooth Twist to Unlock mechanism for a secure fit and simple removal of the sockets
- With Take it easy tool finder: colour coding by size

Magnetic socket rail B 4 Zyklop socket set, 3/8" drive



Code	EAN		
05005430001	4013288 223234		1
		● 8790 HMB 1x 8,0x29,0; 1x 10,0x29,0; 1x 12,0x29,0; 1x 13,0x29,0; 1x 15,0x29,0; 1x 16,0x30,0; 1x 17,0x30,0; 1x 18,0x30,0; 1x 19,0x30,0	
		9601 1x 30,0x340,0	

Magnetic socket rail B Imperial 1 Zyklop socket set 3/8" drive, imperial

Socket rail with 9 manual and machine sockets (non-impact), 3/8". A smooth rotary mechanism allows a secure hold and easy access of the sockets.

With Take it easy tool finder with colour coding by size - to help you find the required tool quickly and easily. The rail allows temporary attachment to metallic surfaces and, with its twist-to-unlock function, ensures secure locking and unlocking of the sockets.

- 9-piece socket set on socket rail, 3/8"
- Rail with secure bit mounting and yet easy removal (twist-to-unlock) for temporary attachment on wall, shelf or workshop trolley
- Smooth Twist to Unlock mechanism for a secure fit and simple removal of the sockets
- With Take it easy tool finder: colour coding by size

Magnetic socket rail B Imperial 1 Zyklop socket set 3/8" drive, imperial



Code	EAN		
05005450001	4013288 223258		1
		● 8790 HMB 1x 1/4"x29,0; 1x 5/16"x29,0; 1x 11/32"x29,0; 1x 3/8"x29,0; 1x 7/16"x29,0; 1x 1/2"x29,0; 1x 9/16"x29,0; 1x 5/8"x30,0; 1x 3/4"x30,0	
		9601 1x 30,0x340,0	

8790 HMB Deep 3/8" socket

Long 3/8" hand and machine socket (ISO 2725 part 3) with ball intercept ring; for external hexagonal bolts and sockets. For use in manual and machine operation (non-impact), even with low-lying screwdriving and protruding threaded rods.

With Take it easy tool finder with colour coding by size - for easy and fast location of the required tool. Easy to grasp even with oily hands. The hexagon profile allows the transmission of high forces and puts less strain on the edges of bolts or screw heads than a double hexagon profile.

Fine-toothed ratchets also make the use of a double hexagon profile superfluous, even in confined spaces, thanks to their small back-pivoting angle.

- Long sockets for low-lying screwdriving, often even with protruding threaded rods in small spaces
- Hexagonal profile enables precise bolting with high power transmission and preserves the profile
- Take it easy tool finder with colour coding according to sizes
- Knurling at lower end to enable easy gripping when used in manual applications
- For manual and machine operation (non-impact), ball intercept ring
- Made of matt chromed chrome-vanadium

8790 HMB Deep 3/8" socket



Code	EAN		mm	mm	mm	mm	
05004530001	210388		8,0	64,0	12,2	17,0	1
05004531001	210395		9,0	64,0	13,5	17,0	1
05004532001	210401		10,0	64,0	14,5	17,0	1
05004533001	210418		11,0	64,0	15,7	17,0	1
05004534001	210425		12,0	64,0	16,5	18,0	1
05004535001	210432		13,0	64,0	19,0	17,0	1
05004536001	210449		14,0	64,0	20,0	18,0	1
05004537001	210456		15,0	64,0	22,0	20,0	1
05004538001	210463		16,0	64,0	22,0	20,0	1
05004539001	210470		17,0	64,0	24,0	22,0	1
05004540001	210487		18,0	64,0	26,0	23,0	1
05004541001	210494		19,0	64,0	26,0	23,0	1
05004542001	210500		20,0	64,0	28,0	25,0	1
05004543001	210517		21,0	64,0	28,0	25,0	1
05004544001	210524		22,0	64,0	30,0	26,0	1

Belt B Deep 1 socket set, 3/8" drive

Robust textile belt in the typical Wera design with 9 long 3/8" manual and machine socket inserts (non-impacting) in a confined space. A smoother turning mechanism ensures a secure holding and easy removal of sockets. Includes snap hook for attaching to belt loops or bags. With fleece backing and hook and loop fastener strips for easy attachment e.g. on wall, shelf, workshop trolley or the Wera 2go tool transport system.

Long 3/8" manual and mechanical socket wrench inserts (ISO 2725 part 3) from Wera for use in manual and machine operation (non-impacting) even with low-lying screwdriving and protruding threaded rods.

With Take it easy tool finder with colour coding by size - for easy and fast location of the required tool. Easy to grasp even with oily hands. With hexagonal profile and ball-catching groove. The hexagon profile allows the transmission of high forces and puts less strain on the edges of bolts or screw heads than a double hexagon profile.

Fine-toothed ratchets also make the use of a double hexagon profile superfluous, even in confined spaces, thanks to their small back-pivoting angle. For external hexagonal bolts and sockets.

- 9-piece socket set on robust textile belt 3/8"
- Smooth Twist to Unlock mechanism for a secure fit and simple removal of the sockets
- Long 3/8" socket for low-profile-fitting screw connections in tight construction spaces and for protruding threaded rods
- Hexagonal profile enables precise and profile-preserving screwdriving with high power transmission
- Take it easy tool finder with colour coding according to sizes

Belt B Deep 1 socket set, 3/8" drive



Code	EAN		
05004545001	210555		1
		8790 HMB Deep 1x 8,0x64,0; 1x 10,0x64,0; 1x 12,0x64,0; 1x 13,0x64,0; 1x 15,0x64,0; 1x 16,0x64,0; 1x 17,0x64,0; 1x 18,0x64,0; 1x 19,0x64,0	
		Belt B 0/9 1x 45,0x310,0	
		K30 1x 30,0x200,0	

Magnetic socket rail B Deep 1 socket set, 3/8" drive

Socket rail with 9 long manual and machine sockets (non-impact), 3/8". A smooth rotary mechanism allows a secure hold and easy access of the sockets.

Long 3/8" manual and machine sockets (ISO 2725 part 3) by Wera for manual and (non-impact) machine use even at low lying couplings and protruding thread rods.

With Take it easy tool finder with colour coding by size - to help you find the required tool quickly and easily.

Slip-proof for easy grip even with oily hands. With hexagon profile and ball stop groove. The hexagon profile enables the transmission of high forces and loads the edges of the bolt or the screw head less than a double hexagon profile.

Fine-teethed ratchets also make use of a double hexagon profile superfluous, even in confined spaces, thanks to their small return angle. For external hexagon bolts and screws.

The rail allows temporary attachment to metallic surfaces and, with its twist-to-unlock function, ensures secure locking and unlocking of the sockets.

- 9-piece socket set on socket rail, 3/8"
- Rail with secure bit mounting and yet easy removal (twist-to-unlock) for temporary attachment on wall, shelf or workshop trolley
- Smooth Twist to Unlock mechanism for a secure fit and simple removal of the sockets
- Long 3/8" socket for low-profile-fitting screw connections in tight construction spaces and for protruding threaded rods
- Hexagonal profile enables precise and profile-preserving screw-driving with high power transmission

Magnetic socket rail B Deep 1 socket set, 3/8" drive

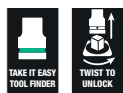

Code	EAN		
05005440001	223241		1
		8790 HMB Deep 1x 8,0x64,0; 1x 10,0x64,0; 1x 12,0x64,0; 1x 13,0x64,0; 1x 15,0x64,0; 1x 16,0x64,0; 1x 17,0x64,0; 1x 18,0x64,0; 1x 19,0x64,0	
		9601 1x 30,0x340,0	

8767 B HF TORX® Zyklop bit socket with holding function, 3/8" drive

- Bit socket (non-impact) for manual or machine tool operations
- The holding function holds screws securely on the tool
- Take it easy tool finder with colour coding according to sizes
- Knurling on lower end for more grip when used manually
- Chrome vanadium steel, matt chrome-plated

8767 B HF TORX® Zyklop bit socket with holding function, 3/8" drive



	EAN						
Code	4013288			mm	mm	mm	
05003059001	189097		TX 10	35,0	12,0	17,5	1
05003060001	188830		TX 15	35,0	12,0	17,5	1
05003061001	188847		TX 20	35,0	12,0	17,5	1
05003062001	188854		TX 25	35,0	12,0	17,5	1
05003063001	188861		TX 25	107,0	12,0	17,5	1
05003064001	188878		TX 27	35,0	12,0	17,5	1
05003065001	188885		TX 27	107,0	12,0	17,5	1
05003066001	188892		TX 30	35,0	12,0	17,5	1
05003067001	188908		TX 30	107,0	12,0	17,5	1
05003068001	188915		TX 40	35,0	12,0	17,5	1
05003069001	188922		TX 40	107,0	12,0	17,5	1
05003070001	188939		TX 45	38,5	12,0	17,5	1
05003071001	188946		TX 45	100,0	12,0	17,5	1
05003072001	188953		TX 50	38,5	12,0	17,5	1
05003073001	188960		TX 50	100,0	12,0	17,5	1

8767 B TORX® Zyklop Bit socket with 3/8" drive, with extra slim profile area

- Bit socket (non-impact) for manual or machine tool operations
- The holding function holds screws securely on the tool
- With Take it easy tool finder: colour coding by size
- Knurling on lower end for more grip when used manually.
- Chrome vanadium steel, matt chrome-plated

8767 B TORX® Zyklop Bit socket with 3/8" drive, with extra slim profile area



Code	EAN							
Code	EAN			mm	mm	mm	mm	
05003074001	227102		TX 25	107,0	12,0	17,5	81,5	1
05003075001	227119		TX 30	107,0	12,0	17,5	81,5	1

Belt B 3 TORX® HF Zyklop bit socket set with holding function, 3/8" drive

Typically Wera designed robust textile belt with 9 sockets taking up minimal space. A smooth Twist to Unlock mechanism ensures a secure fit and simple removal of the sockets.

Comes with Take it easy Tool Finder with colour coding according to size to enable the right tool to be selected easily and quickly. Includes a snap hook for secure fastening to a belt loop or pocket. Especially short, stable bit-sockets with all the advantages of the Wera bit technology.

Bit sockets with holding function for particularly convenient screwdriving with reduced risk of losing the screw when approaching the workpiece. Supplied with a nonwoven reverse side and hook and loop strips for simple attachment e.g. to a wall, shelf, tool trolley and to the Wera 2go tool transport system.

- 9-piece bit-socket set on a robust textile belt, 3/8"
- Bit-sockets with all the advantages of the Wera bit technology
- Bit-sockets with holding function for screws/bolts
- Smooth Twist to Unlock mechanism for a secure fit and simple removal of the sockets
- Suitable for attachment to a wall, shelf, tool trolley and to the Wera 2go System

Belt B 3 TORX® HF Zyklop bit socket set with holding function, 3/8" drive

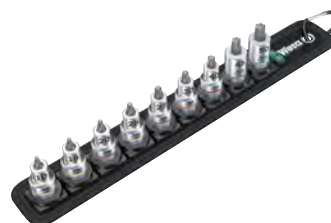

Code	EAN		
05003972001	194961		1
		8767 B HF 1x TX 10x35,0; 1x TX 15x35,0; 1x TX 20x35,0; 1x TX 25x35,0; 1x TX 27x35,0; 1x TX 30x35,0; 1x TX 40x35,0; 1x TX 45x38,5; 1x TX 50x38,5	
		Belt B 0/9 1x 45,0x310,0	
		K30 1x 30,0x200,0	

8767 B TORX® HF 1 Zyklop bit socket set with holding function, 3/8" drive

- Bit sockets with holding function for TORX® screws
- The holding function holds screws securely on the tool
- Take it easy tool finder with colour coding according to sizes
- Knurling on lower socket end for more grip when used manually

8767 B TORX® HF 1 Zyklop bit socket set with holding function, 3/8" drive



Code	EAN		
05003185001	195074		1
		8767 B HF 1x TX 25x107,0; 1x TX 27x107,0; 1x TX 30x107,0; 1x TX 40x107,0; 1x TX 45x100,0; 1x TX 50x100,0	

8740 B HF Zyklop bit socket with holding function, 3/8" drive

- Bit socket (non-impact) for manual or machine tool operations
- The holding function holds screws securely on the tool
- Take it easy tool finder with colour coding according to sizes

8740 B HF Zyklop bit socket with holding function, 3/8" drive

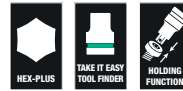

	EAN							
Code	4013288		mm	mm	mm	mm		
05003030001	188557		3,0		35,0	12,0	17,5	1
05003031001	188564		4,0		35,0	12,0	17,5	1
05003032001	188571		4,0		107,0	12,0	17,5	1
05003033001	188649		5,0		35,0	12,0	17,5	1
05003034001	188656		5,0		107,0	12,0	17,5	1
05003035001	188663		6,0		35,0	12,0	17,5	1
05003036001	188731		6,0		107,0	12,0	17,5	1
05003037001	188748		7,0		38,5	12,0	17,5	1
05003038001	188755		7,0		100,0	12,0	17,5	1
05003039001	188779		8,0		38,5	12,0	17,5	1
05003040001	188786		8,0		100,0	12,0	17,5	1
05003041001	188793		9,0		38,5	12,0	17,5	1
05003042001	188809		9,0		100,0	12,0	17,5	1
05003043001	188816		10,0		38,5	12,0	17,5	1
05003044001	188823		10,0		100,0	12,0	17,5	1
05003080001	193407			1/8"	35,0	12,0	17,5	1
05003081001	193414			1/8"	107,0	12,0	17,5	1
05003082001	193421			9/64"	35,0	12,0	17,5	1
05003083001	193438			5/32"	35,0	12,0	17,5	1
05003084001	193445			5/32"	107,0	12,0	17,5	1
05003085001	193452			3/16"	35,0	12,0	17,5	1
05003086001	193551			3/16"	107,0	12,0	17,5	1
05003087001	193568			7/32"	35,0	12,0	17,5	1
05003088001	193575			7/32"	107,0	12,0	17,5	1
05003089001	193612			1/4"	35,0	12,0	17,5	1
05003090001	193629			1/4"	107,0	12,0	17,5	1
05003091001	193636			5/16"	38,5	12,0	17,5	1
05003092001	193643			5/16"	100,0	12,0	17,5	1
05003093001	193650			3/8"	38,5	12,0	17,5	1
05003094001	193667			3/8"	100,0	12,0	17,5	1

8740 B Zyklop Bit socket with 3/8" drive, with extra slim profile area

- Bit socket (non-impact) for manual or machine tool operations
- The holding function holds screws securely on the tool
- With Take it easy tool finder: colour coding by size

8740 B Zyklop Bit socket with 3/8" drive, with extra slim profile area

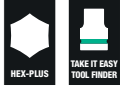

Code	EAN								
05003050001	227058		4,0	107,0	12,0	17,5	81,5	1	
05003051001	227065		5,0	107,0	12,0	17,5	81,5	1	
05003052001	227072		6,0	107,0	12,0	17,5	81,5	1	
05003054001	227089		8,0	100,0	12,0	17,5	74,5	1	
05003056001	227096		10,0	100,0	12,0	17,5	74,5	1	

Belt B 2 Zyklop In-Hex-Plus bit socket set with holding function, 3/8" drive

Typically Wera designed robust textile belt with 8 in-hex bit-sockets taking up minimal space. A smooth Twist to Unlock mechanism ensures a secure fit and simple removal of the sockets.

Comes with Take it easy Tool Finder with colour coding according to size to enable the right tool to be selected easily and quickly.

Includes a snap hook for secure fastening to a belt loop or pocket. Supplied with a nonwoven reverse side and hook and loop strips for simple attachment e.g. to a wall, shelf, tool trolley and to the Wera 2go tool transport system.

- 8-piece bit socket set on a robust textile belt, 3/8"
- Bit-sockets with all the advantages of the Wera bit technology
- Bit-sockets with holding function for screws/bolts
- Smooth Twist to Unlock mechanism for a secure fit and simple removal of the sockets
- Suitable for attachment to a wall, shelf, tool trolley and to the Wera 2go System



Belt B 2 Zyklop In-Hex-Plus bit socket set with holding function, 3/8" drive



Code	EAN		
05003971001	194954		1
		8740 B HF 1x 3,0x35,0; 1x 4,0x35,0; 1x 5,0x35,0; 1x 6,0x35,0; 1x 7,0x38,5; 1x 8,0x38,5; 1x 9,0x38,5; 1x 10,0x38,5	
		Belt B 0/8 1x 45,0x275,0	
		K30 1x 30,0x200,0	

8740 B HF 1 Zyklop bit socket set with holding function, 3/8" drive

- Compact textile box with high robustness, low weight and volume
- Bit socket (non-impact) for manual or power tool operations
- The holding function holds screws securely on the tool
- Take it easy tool finder with colour coding according to sizes
- Knurling on lower socket end for more grip when used manually
- Long design

8740 B HF 1 Zyklop bit socket set with holding function, 3/8" drive



Code	EAN		
05003180001	195050		1
		8740 B HF 1x 4,0x107,0; 1x 5,0x107,0; 1x 6,0x107,0; 1x 7,0x100,0; 1x 8,0x100,0; 1x 9,0x100,0; 1x 10,0x100,0	

8740 B HF Imperial 1 Zyklop bit socket set with holding function, 3/8" drive

- Long version
- Imperial

8740 B HF Imperial 1 Zyklop bit socket set with holding function, 3/8" drive



Code	EAN		
05003181001	195067		1
		8740 B HF 1x 1/8"x107,0; 1x 5/32"x107,0; 1x 3/16"x107,0; 1x 7/32"x107,0; 1x 1/4"x107,0; 1x 5/16"x100,0; 1x 3/8"x100,0	

Belt B Imperial 1 Zyklop In-Hex-Plus bit socket set with holding function, 3/8" drive

Typically Wera designed robust textile belt with 8 in-hex bit-sockets taking up minimal space. A smooth Twist to Unlock mechanism ensures a secure fit and simple removal of the sockets.

Comes with Take it easy Tool Finder with colour coding by size to enable the right tool to be selected easily and quickly.

Includes a snap hook for secure fastening to a belt loop or pocket. Supplied with a nonwoven reverse side and hook and loop strips for simple attachment e.g. to a wall, shelf, tool trolley and to the Wera 2go tool transport system.

- 8-piece bit socket set on a robust textile belt, 3/8"
- Bit-sockets with all the advantages of the Wera bit technology
- Bit-sockets with holding function for screws/bolts
- Smooth Twist to Unlock mechanism for a secure fit and simple removal of the sockets
- Suitable for attachment to a wall, shelf, tool trolley and to the Wera 2go System
- Imperial

Belt B Imperial 1 Zyklop In-Hex-Plus bit socket set with holding function, 3/8" drive

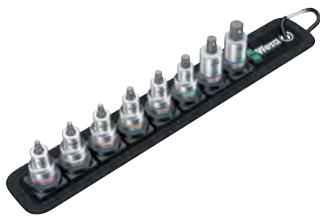

Code	EAN		
05003974001	194985		1
		○ 8740 B HF 1x 1/8"x35,0; 1x 9/64"x35,0; 1x 5/32"x35,0; 1x 3/16"x35,0; 1x 7/32"x35,0; 1x 1/4"x35,0; 1x 5/16"x38,5; 1x 3/8"x38,5	
		Belt B 0/8 1x 45,0x275,0	
		K30 1x 30,0x200,0	

Bicycle set 8

7-piece bit socket set with 3/8" drive for typical bicycle operations. Bit sockets with 30mm long and extra slim profile area for better accessibility in tight workspaces. The knurling facilitates manual screwdriving without slipping.

With Take it easy tool finder with colour coding by size - to help you find the required tool quickly and easily.

- Bit sockets with holding function for the most common TORX® and Hex screws
- The holding function holds screws securely on the tool
- With Take it easy tool finder: colour coding by size
- Knurling on lower socket end for more grip when used manually
- In a robust folding bag for easy transport



Bicycle set 8



Code	EAN		
05004176001	220622		1
		♻️ 8767 B 1x TX 25x107,0; 1x TX 30x107,0	
		○ 8740 B 1x 4,0x107,0; 1x 5,0x107,0; 1x 6,0x107,0; 1x 8,0x100,0; 1x 10,0x100,0	
		K120 1x 50,0x70,0	

8796 LB Zyklop „flexible-lock“ extension with free-turning sleeve, long, 3/8"

- For 3/8" square sockets with ball lock
- Flexible lock system for either locking or rapid exchange of the attached tool
- With free-turning sleeve for rapid tightening and loosening of screws and nuts

8796 LB Zyklop „flexible-lock“ extension with free-turning sleeve, long, 3/8"



Code	EAN	□	⌋						
05003592001	121325	3/8"	200,0						1

8796 SB Zyklop „flexible-lock“ extension with free-turning sleeve, short, 3/8"

- Flexible lock system for either locking or rapid exchange of the attached tool
- For 3/8" square sockets with ball lock
- With free-turning sleeve for rapid tightening and loosening of screws and nuts

8796 SB Zyklop „flexible-lock“ extension with free-turning sleeve, short, 3/8"



Code	EAN	□	⌋						
05003591001	121318	3/8"	125,0						1

8794 LB Zyklop extension with free-turning sleeve, long, 3/8"

Wera Zyklop extension with easy-to-grip free-turning sleeve for rapid tightening and loosening of screws and nuts. Out of high quality chrome vanadium steel, matt chrome-plated.

8794 LB Zyklop extension with free-turning sleeve, long, 3/8"



Code	EAN	□	⌋						
05003583001	121288	3/8"	200,0						1

8794 SB Zyklop extension with free-turning sleeve, short, 3/8"

Wera Zyklop extension with easy-to-grip free-turning sleeve for rapid tightening and loosening of screws and nuts. Out of high quality chrome vanadium steel, matt chrome-plated.

8794 SB Zyklop extension with free-turning sleeve, short, 3/8"



Code	EAN	□	⌋						
05003582001	121271	3/8"	125,0						1

8789 B Zyklop sliding T-handle, 3/8"

Wera ZyklopT-handle for higher torque transfer. For 3/8" square sockets with ball lock. Adjustable drive for more flexible usage. Out of high quality chrome vanadium steel, matt chrome-plated.

8789 B Zyklop sliding T-handle, 3/8"



Code	EAN	□	⌋						
05003581001	121516	3/8"	165,0						3

8795 B Zyklop universal joint, 3/8"

Wera Zyklop universal joint for 3/8" square sockets with ball lock.

8795 B Zyklop universal joint, 3/8"



Code	EAN	□	⌋						
05003585001	121523	3/8"	50,0						1

Zyklop Speed - incredibly fast and incredibly flexible



Incredibly compact set arrangement with many tools in a minimum of space. A completely new ratchet set feeling thanks to the unique textile boxes that are very robust and durable.

They can be positioned upright for tidy storage on the workshop shelf. Additional surface protection due to textile outer material. Low weight and volume for simpler mobility. Take it easy Tool Finder with colour coding according to sizes.

- Freely pivoting ratchet head with 5 predefined locking positions
- Fine tothing with 72 teeth
- Small return angle of only 5°
- Free-turning sleeve for high working speeds
- Take it easy tool finder with colour coding according to sizes
- Compact textile box with high robustness, low weight and volume

8100 SC 6 Zyklop Speed Ratchet Set, 1/2" drive, metric



Code	EAN		
05004076001	4013288 173874		1
		8000 C 1x 1/2"x277,0	
		8790 HMC 1x 10,0x37,0; 1x 11,0x37,0; 1x 12,0x37,0; 1x 13,0x37,0; 1x 14,0x37,0; 1x 15,0x37,0; 1x 16,0x37,0; 1x 17,0x37,0; 1x 18,0x37,0; 1x 19,0x37,0	
		8794 LC 1x 1/2"x250,0	
		8794 C 1x 1/2"x52,0	
		8784 C2 1x 5/16"x1/2"x50,0	
		851/2 Z PH 1x PH 2x32; 1x PH 3x32	
		855/2 Z PZ 1x PZ 2x32; 1x PZ 3x32	
		867/2 Z TORX® 1x TX 20x35; 1x TX 25x35; 1x TX 30x35; 1x TX 40x35; 1x TX 45x35; 1x TX 50x35	
		840/2 Z 1x 5x30; 1x 6x30; 1x 8x30; 1x 10x30	

8100 SC 9 Zyklop Speed Ratchet Set, 1/2" drive, imperial



Code	EAN		
05004079001	4013288 173997		1
		<input type="checkbox"/> 8000 C 1x 1/2"x277,0	
		<input checked="" type="checkbox"/> 8790 HMC 1x 3/8"x37,0; 1x 7/16"x37,0; 1x 1/2"x37,0; 1x 9/16"x37,0; 1x 19/32"x37,0; 1x 5/8"x37,0; 1x 11/16"x37,0; 1x 3/4"x37,0; 1x 25/32"x37,0; 1x 13/16"x37,0	
		<input checked="" type="checkbox"/> <input type="checkbox"/> 8794 LC 1x 1/2"x250,0	
		<input checked="" type="checkbox"/> <input type="checkbox"/> 8794 C 1x 1/2"x52,0	
		<input checked="" type="checkbox"/> <input checked="" type="checkbox"/> 8784 C2 1x 5/16"x1/2"x50,0	
		<input checked="" type="checkbox"/> 851/2 Z PH 1x PH 2x32; 1x PH 3x32	
		<input checked="" type="checkbox"/> 855/2 Z PZ 1x PZ 2x32; 1x PZ 3x32	
		<input checked="" type="checkbox"/> 867/2 Z TORX® 1x TX 20x35; 1x TX 25x35; 1x TX 30x35; 1x TX 40x35; 1x TX 45x35; 1x TX 50x35	
		<input type="checkbox"/> 840/2 Z 1x 7/32"x30; 1x 1/4"x30; 1x 5/16"x30; 1x 3/8"x30	

8100 SC 2 Zyklop Speed Ratchet Set, 1/2" drive, metric

- 37-piece set in a robust metal case

8100 SC 2 Zyklop Speed Ratchet Set, 1/2" drive, metric



Code	EAN		
05003645001	4013288 121189		1
		<input type="checkbox"/> 8000 C 1x 1/2"x277,0	
		<input checked="" type="checkbox"/> 8790 HMC 1x 10,0x37,0; 1x 11,0x37,0; 1x 12,0x37,0; 1x 13,0x37,0; 1x 14,0x37,0; 1x 15,0x37,0; 1x 16,0x37,0; 1x 17,0x37,0; 1x 18,0x37,0; 1x 19,0x37,0; 1x 20,0x37,0; 1x 21,0x37,0; 1x 22,0x37,0; 1x 24,0x37,0; 1x 27,0x40,0; 1x 30,0x42,0; 1x 32,0x42,0	
		<input type="checkbox"/> 8789 C 1x 1/2"x250,0	
		<input checked="" type="checkbox"/> <input type="checkbox"/> 8794 C 1x 1/2"x52,0	
		<input checked="" type="checkbox"/> <input type="checkbox"/> 8795 C 1x 1/2"x69,0	
		<input checked="" type="checkbox"/> <input checked="" type="checkbox"/> 8784 C2 1x 5/16"x1/2"x50,0	
		<input checked="" type="checkbox"/> <input type="checkbox"/> 8796 SC 1x 1/2"x125,0	
		<input checked="" type="checkbox"/> <input type="checkbox"/> 8796 LC 1x 1/2"x250,0	
		<input checked="" type="checkbox"/> 851/2 Z PH 1x PH 3x32	
		<input checked="" type="checkbox"/> 855/2 Z PZ 1x PZ 3x32	
		<input checked="" type="checkbox"/> 867/2 Z TORX® 1x TX 20x35; 1x TX 25x35; 1x TX 30x35; 1x TX 40x35; 1x TX 45x35; 1x TX 50x35; 1x TX 55x35	
		<input type="checkbox"/> 840/2 Z 1x 5x30; 1x 6x30; 1x 8x30; 1x 10x30	

8100 SC 4 Zyklop Speed Ratchet Set, 1/2" drive, imperial

- 38-piece set in a robust metal case

8100 SC 4 Zyklop Speed Ratchet Set, 1/2" drive, imperial



Code	EAN			
05003647001	121202			1
		<input type="checkbox"/>	8000 C 1x 1/2"x277,0	
		<input checked="" type="checkbox"/>	8790 HMC 1x 3/8"x37,0; 1x 7/16"x37,0; 1x 1/2"x37,0; 1x 9/16"x37,0; 1x 19/32"x37,0; 1x 5/8"x37,0; 1x 11/16"x37,0; 1x 3/4"x37,0; 1x 25/32"x37,0; 1x 13/16"x37,0; 1x 7/8"x37,0; 1x 15/16"x37,0; 1x 31/32"x37,0; 1x 1"x40,0; 1x 1 1/16"x40,0; 1x 1 1/8"x40,0; 1x 1 3/16"x42,0; 1x 1 1/4"x42,0	
		<input type="checkbox"/>	8789 C 1x 1/2"x250,0	
		<input checked="" type="checkbox"/>	8794 C 1x 1/2"x52,0	
		<input checked="" type="checkbox"/>	8795 C 1x 1/2"x69,0	
		<input checked="" type="checkbox"/>	8784 C2 1x 5/16"x1/2"x50,0	
		<input checked="" type="checkbox"/>	8796 SC 1x 1/2"x125,0	
		<input checked="" type="checkbox"/>	8796 LC 1x 1/2"x250,0	
		<input checked="" type="checkbox"/>	851/2 Z PH 1x PH 3x32	
		<input checked="" type="checkbox"/>	855/2 Z PZ 1x PZ 3x32	
		<input checked="" type="checkbox"/>	867/2 Z TORX® 1x TX 20x35; 1x TX 25x35; 1x TX 30x35; 1x TX 40x35; 1x TX 45x35; 1x TX 50x35; 1x TX 55x35	
		<input type="checkbox"/>	840/2 Z 1x 7/32"x30; 1x 1/4"x30; 1x 5/16"x30; 1x 3/8"x30	

8000 C Zyklop Speed Ratchet with 1/2" drive

- Combines five different types of a ratchet in one
- Flywheel design and easy-to-grip free-turning sleeve for very high working speeds
- Freely pivoting ratchet head, push button release and left/right switchover
- Fine-tooth design allows a small return angle of 5°
- Can also be used as a screwdriver

8000 C Zyklop Speed Ratchet with 1/2" drive



Code	EAN				
05003600001	121882	1/2"	277,0		1

8000 C SB Zyklop Speed Ratchet with 1/2" drive



Code	EAN			
05073262001	128058	<input type="checkbox"/>	8000 C 1x 1/2"x277.0	3

Zyklop Hybrid - longer for more torque

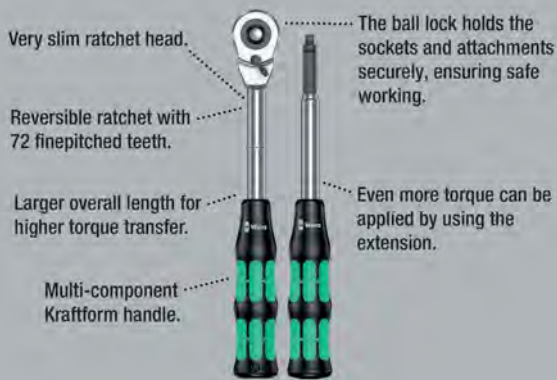

Zyklop Hybrid ratchet set, 1/2" drive, metric. Including Zyklop Hybrid ratchet and Hybrid handle extension.

- Switchover lever for convenient direction change
- Fine-pitched with 72 teeth for a return angle of only 5°
- Compact textile box with high robustness, low weight and volume
- Colour coding of the sockets according to size
- Smooth Twist to Unlock mechanism for a secure fit and simple removal of the sockets

8006 SC 1 Zyklop Hybrid Ratchet Set, 1/2" drive, metric



Code	EAN			
05004090001	182159			1
		8006 C	1x 1/2"x281,0	
		8797 C	1x 271,0	
		8794 LC	1x 1/2"x250,0	
		8790 HMC HF	1x 10,0x37,0; 1x 11,0x37,0; 1x 12,0x37,0; 1x 13,0x37,0; 1x 14,0x37,0; 1x 15,0x37,0; 1x 16,0x37,0; 1x 17,0x37,0; 1x 18,0x37,0; 1x 19,0x37,0	

Zyklop Hybrid Set

Zyklop Hybrid ratchet set, 1/2" drive, metric. Including Zyklop Hybrid ratchet and Hybrid handle extension, extension and 10 sockets.

- Zyklop Hybrid ratchet with long overall length (leverage effect) and slim ratchet head
- Fine-pitched with 72 teeth for a return angle of only 5°
- Extension with unlocking pin

Zyklop Hybrid Set



Code	EAN			
05004095001	184320			1
		8006 C	1x 1/2"x281,0	
		8797 C	1x 271,0	

8006 C Zyklop Hybrid Ratchet with switch lever and 1/2" drive

Zyklop Hybrid ratchet with switchover lever and 1/2" drive, low weight, ergonomic Kraftform handle with slim head design, long lever and with an extension option.

8006 C Zyklop Hybrid Ratchet with switch lever and 1/2" drive



Code	EAN		mm	mm	mm		
05003780001	184214	1/2"	281,0	34	37		3

8797 C Zyklop Hybrid extension

- Can be used with Zyklop Hybrid 8006 C
- To increase the torque to be applied
- Multi-component Kraftform handle optimised to withstand pressure and tensile loads
- With unlocking pin
- Blade out of tough, tempered chrome-molybdenum steel

8797 C Zyklop Hybrid extension



	EAN	⌀	ℓ						
Code	4013288	mm	mm						
05003781001	183200	271,0	134,0						1

Zyklop Metal with push-through square

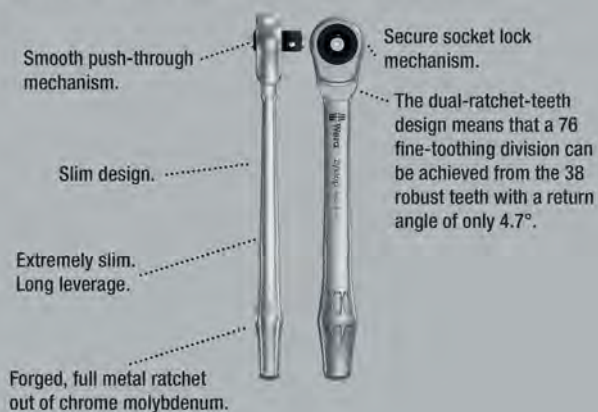

Incredibly compact set arrangement with many tools in a minimum of space. A completely new ratchet set feeling thanks to the unique textile boxes that are very robust and durable.

They can be positioned upright for tidy storage on the workshop shelf. Additional surface protection due to textile outer material. Low weight and volume for simpler mobility.

Take it easy Tool Finder with colour coding according to sizes.

- Extremely slim ratchet with long lever
- Return angle of only 4.7°
- Absolutely smooth switchover of the non-detachable push-through square
- Take it easy tool finder system

8100 SC 7 Zyklop Metal Ratchet Set with push-through square, 1/2" drive, metric



Code	EAN		
05004077001	173942		1
		<ul style="list-style-type: none"> 8003 C 1x 1/2"x281,0 8790 HMC 1x 10,0x37,0; 1x 11,0x37,0; 1x 12,0x37,0; 1x 13,0x37,0; 1x 14,0x37,0; 1x 15,0x37,0; 1x 16,0x37,0; 1x 17,0x37,0; 1x 18,0x37,0; 1x 19,0x37,0 8794 LC 1x 1/2"x250,0 8794 C 1x 1/2"x52,0 8784 C2 1x 5/16"x1/2"x50,0 851/2 Z PH 1x PH 2x32; 1x PH 3x32 867/2 Z TORX® 1x TX 20x35; 1x TX 25x35; 1x TX 27x35; 1x TX 30x35; 1x TX 40x35; 1x TX 45x35; 1x TX 50x35; 1x TX 55x35 840/2 Z 1x 5x30; 1x 6x30; 1x 8x30; 1x 10x30 	

8100 SC 10 Zyklop Metal Ratchet Set with push-through square, 1/2" drive, imperial



Code	EAN			
05004080001	173966			1
		8003 C	1x 1/2"x281,0	
		8790 HMC	1x 3/8"x37,0; 1x 7/16"x37,0; 1x 1/2"x37,0; 1x 9/16"x37,0; 1x 19/32"x37,0; 1x 5/8"x37,0; 1x 11/16"x37,0; 1x 3/4"x37,0; 1x 25/32"x37,0; 1x 13/16"x37,0	
		8794 LC	1x 1/2"x250,0	
		8794 C	1x 1/2"x52,0	
		8784 C2	1x 5/16"x1/2"x50,0	
		851/2 Z PH	1x PH 2x32; 1x PH 3x32	
		867/2 Z TORX®	1x TX 20x35; 1x TX 25x35; 1x TX 27x35; 1x TX 30x35; 1x TX 40x35; 1x TX 45x35; 1x TX 50x35; 1x TX 55x35	
		840/2 Z	1x 7/32"x30; 1x 1/4"x30; 1x 5/16"x30; 1x 3/8"x30	

8003 C Zyklop Metal Ratchet with push-through square and 1/2" drive

- Forged, full metal ratchet (chrome-molybdenum); slim design to enable work in very confined spaces.
- The dual-ratchet-teeth design means that a 76 fine-toothing division can be achieved from the 38 robust teeth with a return angle of only 4.7°.
- Absolutely smooth switchover of the non-detachable push-through square
- For 1/2" square sockets with ball lock

8003 C Zyklop Metal Ratchet with push-through square and 1/2" drive



Code	EAN					
05004063001	174055	1/2"	281,0	36	37	3

Zyklop Metal with switch lever



Incredibly compact set arrangement with many tools in a minimum of space. A completely new ratchet set feeling thanks to the unique textile boxes that are very robust and durable.

They can be positioned upright for tidy storage on the workshop shelf. Additional surface protection due to textile outer material. Low weight and volume for simpler mobility.

Take it easy Tool Finder with colour coding according to sizes.

- Convenient direction change thanks to switchover lever
- Extremely slim ratchet with long lever
- Return angle of only 5°

8100 SC 8 Zyklop Metal Ratchet Set with switch lever, 1/2" drive, metric



Code	EAN			
05004078001	173881			1
		8004 C	1x 1/2"x281,0	
		8790 HMC	1x 10,0x37,0; 1x 11,0x37,0; 1x 12,0x37,0; 1x 13,0x37,0; 1x 14,0x37,0; 1x 15,0x37,0; 1x 16,0x37,0; 1x 17,0x37,0; 1x 18,0x37,0; 1x 19,0x37,0	
		8794 LC	1x 1/2"x250,0	
		8794 C	1x 1/2"x52,0	
		8784 C2	1x 5/16"x1/2"x50,0	
		851/2 Z PH	1x PH 2x32; 1x PH 3x32	
		867/2 Z TORX®	1x TX 20x35; 1x TX 25x35; 1x TX 27x35; 1x TX 30x35; 1x TX 40x35; 1x TX 45x35; 1x TX 50x35; 1x TX 55x35	
		840/2 Z	1x 5x30; 1x 6x30; 1x 8x30; 1x 10x30	

8100 SC 11 Zyklop Metal Ratchet Set with switch lever, 1/2" drive, imperial



Code	EAN			
05004081001	4013288 173973			1
		8004 C		
		1x 1/2"x281,0		
		8790 HMC		
		1x 3/8"x37,0; 1x 7/16"x37,0; 1x 1/2"x37,0;		
		1x 9/16"x37,0; 1x 19/32"x37,0; 1x 5/8"x37,0;		
		1x 11/16"x37,0; 1x 3/4"x37,0; 1x 25/32"x37,0;		
		1x 13/16"x37,0		
		8794 LC		
		1x 1/2"x250,0		
		8794 C		
		1x 1/2"x52,0		
		8784 C2		
		1x 9/16"x1/2"x50,0		
		851/2 Z PH		
		1x PH 2x32; 1x PH 3x32		
		867/2 Z TORX®		
		1x TX 20x35; 1x TX 25x35; 1x TX 27x35;		
		1x TX 30x35; 1x TX 40x35; 1x TX 45x35;		
		1x TX 50x35; 1x TX 55x35		
		840/2 Z		
		1x 7/32"x30; 1x 1/4"x30; 1x 5/16"x30;		
		1x 3/8"x30		

8004 C Zyklop Metal Ratchet with switch lever and 1/2" drive

- Convenient direction change thanks to switchover lever
- Extremely slim ratchet with long lever
- Return angle of only 5°
- Secure socket locking

8004 C Zyklop Metal Ratchet with switch lever and 1/2" drive



Code	EAN		mm	mm	mm		
05004064001	4013288 174062	1/2"	281,0	34	37		3

8790 C Impaktor socket with 1/2" drive

Impaktor socket for use with electric or pneumatic impact wrenches with 12.5mm = 1/2" drive. The Impaktor technology ensures above-average service life even under extreme conditions.

With Take it easy tool finder with colour coding by size - for easy and fast location of the required tool. With hexagonal profile and grooved socket.

The hexagon profile allows the transmission of high forces and puts less strain on the edges of bolts or screw heads than a double hexagon profile. For hexagon headed bolts, screws and nuts.

- For use with electric or pneumatic powered impact wrenches with 12.5mm = 1/2" drive
- Impaktor technology for above-average service life
- Hexagonal profile enables precise and profile-preserving screwdriving with high power transmission
- With Take it easy tool finder: colour coding by size
- With cross-bore and ring socket for securing locking pin and locking ring of machine-operated tools

8790 C Impaktor socket with 1/2" drive



Code	EAN		mm	mm	mm	mm	
05004570001	4013288 210012		13,0	38,0	21,0	24,0	1
05004571001	210029		14,0	38,0	22,0	24,0	1
05004572001	210036		15,0	38,0	24,0	24,0	1
05004573001	210043		16,0	38,0	24,0	24,0	1
05004574001	210050		17,0	38,0	26,0	26,0	1
05004575001	210067		18,0	38,0	28,0	28,0	1
05004576001	210074		19,0	38,0	28,0	28,0	1
05004577001	210081		20,0	38,0	26,0	30,0	1
05004578001	210098		21,0	38,0	26,0	30,0	1

Belt C Impaktor 1 socket set, 1/2" drive

Robust textile belt in the typical Wera design with nine Impaktor socket wrench plug-ins for missions in confined spaces. A smooth Twist to Unlock mechanism ensures a secure fit and simple removal of the sockets. Including snap hook for attachment on belt loops or bags.

With fleece backing and hook and loop fastener strips for easy attachment e.g. on wall, shelf, workshop trolley and Wera 2go tool transport system. Impaktor sockets for use with electric or pneumatic powered impact wrenches with 12.5mm = 1/2" drive.

Impaktor technology ensures above-average service life, even under extreme conditions. With Take it easy tool finder with colour coding by size - for easy and fast location of the required tool. With hexagonal profile and grooved socket.

The hexagon profile allows the transmission of high forces and puts less strain on the edges of bolts or screw heads than a double hexagon profile. For external hexagonal bolts and sockets.

- 9-piece socket set on robust textile belt 1/2"
- Smooth Twist to Unlock mechanism for a secure fit and simple removal of the sockets
- Particularly suitable for use with customary impact drivers
- With Take it easy tool finder: colour coding by size
- Suitable for attachment to a wall, shelf, tool trolley and to the Wera 2go System

Belt C Impaktor 1 socket set, 1/2" drive



Code	EAN		
05004580001	210104		1
		8790 C Impaktor 1x 13,0x38,0; 1x 14,0x38,0; 1x 15,0x38,0; 1x 16,0x38,0; 1x 17,0x38,0; 1x 18,0x38,0; 1x 19,0x38,0; 1x 20,0x38,0; 1x 21,0x38,0	
		Belt C Impaktor 0/9 1x 71,0x210,0	
		K30 1x 30,0x200,0	

Magnetic socket rail C Impaktor 1 socket set, 1/2" drive

Socket rail with 9 Impaktor sockets for use with electric or pneumatic wrenches with 12.5 mm = 1/2" drive.

The Impaktor technology ensures a higher-than-average service life even at extreme requirements.

The hexagon profile used allows a high power transmission while simultaneously being precise and protecting the profile.

With Take it easy tool finder with colour coding by size - to help you find the required tool quickly and easily.

The rail allows temporary attachment to metallic surfaces and, with its twist-to-unlock function, ensures secure locking and unlocking of the sockets.

- 9-piece socket set on socket rail, 1/2"
- For use with electric or pneumatic powered impact wrenches with 12.5mm = 1/2" drive
- Impaktor technology for above-average service life
- Hexagonal profile enables precise and profile-preserving screwdriving with high power transmission
- With cross-bore and ring socket for securing locking pin and locking ring of machine-operated tools



Magnetic socket rail C Impaktor 1 socket set, 1/2" drive



Code	EAN		
05005490001	223289		1
		8790 C Impaktor 1x 13,0x38,0; 1x 14,0x38,0; 1x 15,0x38,0; 1x 16,0x38,0; 1x 17,0x38,0; 1x 18,0x38,0; 1x 19,0x38,0; 1x 20,0x38,0; 1x 21,0x38,0	
		9602 1x 30,0x370,0	

8790 C Impaktor Deep socket with 1/2" drive

Long Impaktor socket for use with electric or pneumatic wrenches with 12.5 mm = 1/2" drive. For use even at low lying couplings and protruding thread rods.

The Impaktor technology ensures a higher-than-average service life even at extreme requirements. With Take it easy tool finder with colour coding by size – to help you find the required tool quickly and easily.

With hexagon profile with socket and well. With hexagon profile with socket and well. The hexagon profile enables the transmission of high forces and loads the edges of the bolt or the screw head less than a double hexagon profile. For external hexagon bolts and screws.

- Robust Impaktor sockets for extremely high stress; for use with electric or pneumatic wrenches with 12.5 mm = 1/2" drive
- Long socket wrenches for low lying couplings, also suitable for fitting, protruding thread rods in confined spaces
- With cross-bore and ring socket for securing locking pin and locking ring of machine-operated tools

8790 C Impaktor Deep Set 1

Set with 11 Impaktor Deep sockets for use with electric or pneumatic wrenches with 12.5 mm = 1/2" drive. Long design for low-lying couplings and protruding thread rods.

The Impaktor technology ensures a higher-than-average service life even at extreme requirements.

The hexagon profile used allows a high power transmission while simultaneously being precise and protecting the profile. With Take it easy tool finder with colour coding by size - for quick and easy identification of the required tool .

- Long 1/2" sockets for low-profile-fitting screw connections in tight construction spaces and for protruding threaded rods
- For use with electric or pneumatic powered impact wrenches with 12.5mm = 1/2" drive
- Impaktor technology for above-average service life
- Hexagonal profile enables precise and profile-preserving screwdriving with high power transmission
- With cross-bore and ring socket for securing locking pin and locking ring of machine-operated tools
- With Take it easy tool finder: colour coding by size
- In a robust textile box

8790 C Impaktor Deep socket with 1/2" drive



Code	EAN		mm	mm	mm	mm	
05004830001	221926		13,0	83,0	21,0	24,0	1
05004831001	221933		14,0	83,0	22,0	24,0	1
05004832001	221940		15,0	83,0	24,0	24,0	1
05004833001	221957		16,0	83,0	24,0	24,0	1
05004834001	221964		17,0	83,0	26,0	26,0	1
05004835001	221995		18,0	83,0	28,0	28,0	1
05004836001	222008		19,0	83,0	28,0	28,0	1
05004837001	222015		21,0	83,0	30,0	27,0	1
05004838001	222107		22,0	83,0	32,0	28,0	1
05004839001	222114		24,0	83,0	34,0	30,0	1
05004840001	222121		27,0	83,0	38,0	33,0	1

8790 C Impaktor Deep Set 1



Code	EAN		
05004841001	224088		1
		8790 C Impaktor Deep 1x 13,0x83,0; 1x 14,0x83,0; 1x 15,0x83,0; 1x 16,0x83,0; 1x 17,0x83,0; 1x 18,0x83,0; 1x 19,0x83,0; 1x 21,0x83,0; 1x 22,0x83,0; 1x 24,0x83,0; 1x 27,0x83,0	

8790 HMC Zyklop socket with 1/2" drive

- 1/2" inch Zyklop socket
- For manual and power tool operations (non-impact)
- Knurling at lower end to enable easy gripping when used in manual applications
- Equipped with ball stop groove
- Take it easy tool finder with colour coding according to sizes

8790 HMC Zyklop socket with 1/2" drive



Code	EAN							
Code	4013288		mm		mm	mm	mm	
05003601001	120618		10,0		37,0	15,5	24,0	1
05003602001	120625		11,0		37,0	16,5	24,0	1
05003603001	120656		12,0		37,0	17,5	24,0	1
05003604001	120663		13,0		37,0	19,0	24,0	1
05003605001	120670		14,0		37,0	20,0	24,0	1
05003606001	120687		15,0		37,0	21,0	24,0	1
05003607001	120694		16,0		37,0	22,5	24,0	1
05003608001	120700		17,0		37,0	24,0	26,0	1
05003609001	120717		18,0		37,0	25,0	26,0	1
05003610001	120724		19,0		37,0	26,5	26,0	1
05003611001	120731		20,0		37,0	28,0	26,0	1
05003612001	120748		21,0		37,0	29,0	26,0	1
05003613001	120755		22,0		37,0	30,5	26,0	1
05003614001	120762		24,0		37,0	33,0	28,0	1
05003615001	120779		27,0		40,0	36,5	32,0	1
05003616001	120786		30,0		42,0	40,0	34,0	1
05003617001	120793		32,0		42,0	42,0	36,0	1
05003618001	120809			3/8"	37,0	15,5	24,0	1
05003619001	120816			7/16"	37,0	16,5	24,0	1
05003620001	120823			1/2"	37,0	19,0	24,0	1
05003621001	120830			9/16"	37,0	20,0	24,0	1
05003622001	120847			19/32"	37,0	21,0	24,0	1
05003623001	120854			5/8"	37,0	22,5	24,0	1
05003624001	120861			11/16"	37,0	25,5	26,0	1
05003625001	120878			3/4"	37,0	26,5	26,0	1
05003626001	120885			25/32"	37,0	28,0	26,0	1
05003627001	120892			13/16"	37,0	29,0	26,0	1
05003628001	120908			7/8"	37,0	30,5	26,0	1
05003629001	120915			15/16"	37,0	33,0	28,0	1
05003630001	120922			31/32"	37,0	33,0	28,0	1
05003631001	120939			1"	40,0	36,5	32,0	1
05003632001	120946			1 1/16"	40,0	36,5	32,0	1
05003633001	120953			1 1/8"	40,0	40,0	34,0	1
05003634001	120960			1 3/16"	42,0	40,0	34,0	1
05003635001	120977			1 1/4"	42,0	42,0	36,0	1

8790 HMC HF Zyklop socket with 1/2" drive with holding function

- Socket (non-impact) for manual or power tool operations
- The holding function holds screws securely on the tool
- Take it easy tool finder with colour coding according to sizes
- Chrome vanadium steel, matt chrome-plated
- Equipped with ball stop groove, knurling at lower end for better gripping

8790 HMC HF Zyklop socket with 1/2" drive with holding function



Code	EAN							
Code	4013288		mm	mm	mm	mm	mm	
05003730001	180957		10,0	37,0	17,8	23,5	10,4	1
05003731001	180964		11,0	37,0	18,8	23,5	10,4	1
05003732001	180971		12,0	37,0	20,4	23,5	11,4	1
05003733001	181022		13,0	37,0	21,4	23,5	11,4	1
05003734001	181039		14,0	37,0	22,6	23,5	11,4	1
05003735001	181046		15,0	37,0	23,6	23,5	12,0	1
05003736001	181053		16,0	37,0	25,0	23,5	12,0	1
05003737001	181060		17,0	37,0	26,8	23,5	12,5	1
05003738001	181077		18,0	37,0	28,0	23,5	12,5	1
05003739001	181084		19,0	37,0	29,2	23,5	14,0	1

Belt C 1 Zyklop socket set with holding function, 1/2" drive

Typically Wera designed robust textile belt with 6 sockets taking up minimal space. A smooth Twist to Unlock mechanism ensures a secure fit and simple removal of the sockets.

Comes with Take it easy Tool Finder with colour coding according to size to enable the right tool to be selected easily and quickly.

Includes a snap hook for secure fastening to a belt loop or pocket. Sockets with holding function for particularly convenient screwdriving with reduced risk of losing the screw when approaching the workpiece.

Supplied with a non-woven reverse side and hook and loop strips for simple attachment e.g. to a wall, shelf, tool trolley and to the Wera 2go tool transport system.

- 7-piece socket set on a robust textile belt, 1/2"
- Sockets with holding function for screws/bolts/nuts
- Smooth Twist to Unlock mechanism for a secure fit and simple removal of the sockets
- Take it easy tool finder with colour coding according to sizes
- Suitable for attachment to a wall, shelf, tool trolley and to the Wera 2go System

Belt C 1 Zyklop socket set with holding function, 1/2" drive



Code	EAN		
05003995001	204400		1
		● 8790 HMC HF 1x 10,0x37,0; 1x 13,0x37,0; 1x 15,0x37,0; 1x 16,0x37,0; 1x 17,0x37,0; 1x 19,0x37,0	
		ME1 1x 14,0x43,0	
		Belt C 0/6 1x 45,0x275,0	
		K30 1x 30,0x200,0	

Magnetic socket rail C Imperial 1 Zyklop socket set, 1/2" drive, imperial

Socket rail with 9 manual and machine socket wrench inserts (non-impact), 1/2". A smooth rotary mechanism allows a secure hold and easy access of the sockets.

With Take it easy tool finder with colour coding by size - to help you find the required tool quickly and easily.

The rail allows temporary attachment to metallic surfaces and, with its twist-to-unlock function, ensures secure locking and unlocking of the sockets.

- 9-piece socket set on socket rail, 1/2"
- Rail with secure bit mounting and yet easy removal (twist-to-unlock) for temporary attachment on wall, shelf or workshop trolley
- Smooth Twist to Unlock mechanism for a secure fit and simple removal of the sockets
- With Take it easy tool finder: colour coding by size

Magnetic socket rail C Imperial 1 Zyklop socket set, 1/2" drive, imperial

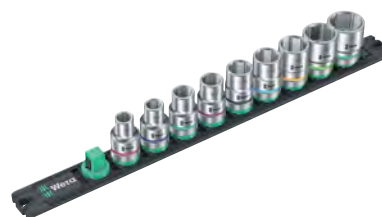

Code	EAN		
05005480001	223296		1
		● 8790 HMC 1x 3/8"x37,0; 1x 7/16"x37,0; 1x 1/2"x37,0; 1x 9/16"x37,0; 1x 5/8"x37,0; 1x 11/16"x37,0; 1x 3/4"x37,0; 1x 7/8"x37,0; 1x 1"x40,0	
		9602 1x 30,0x370,0	

8790 HMC HF 1 Zyklop socket set with 1/2" drive, with holding function

Socket set with holding function for particularly convenient screwdriving with reduced risk of losing the screw when addressing the workpiece.

- Compact textile box with high robustness, low weight and volume
- Bit socket (non-impact) for manual or power tool operations
- The holding function holds screws securely on the tool
- Take it easy tool finder with colour coding according to sizes
- Knurling on lower socket end for more grip when used manually

8790 HMC HF 1 Zyklop socket set with 1/2" drive, with holding function



Code	EAN		
05004203001	184238		1
		8790 HMC HF 1x 10,0x37,0; 1x 11,0x37,0; 1x 12,0x37,0; 1x 13,0x37,0; 1x 14,0x37,0; 1x 15,0x37,0; 1x 16,0x37,0; 1x 17,0x37,0; 1x 18,0x37,0; 1x 19,0x37,0	

8790 C Wheel Impaktor Socket with 1/2" drive

Impaktor socket, 1/2", for use with impact wrenches, with rotating smooth plastic sleeve for higher working speed, better accuracy during screwdriving and additional rim protection.

- For use with electric or pneumatic impact wrenches with 12.5mm = 1/2" drive
- Robust Impaktor design for extremely high stresses
- Hexagonal profile enables precise and profile-preserving screwdriving with high power transmission
- Take it easy tool finder with colour coding according to sizes

8790 C Wheel Impaktor Socket with 1/2" drive



Code	EAN					
05004590001	210739	17,0	85,0	30,0		1
05004591001	210746	19,0	85,0	30,0		1
05004592001	210753	21,0	85,0	32,0		1



Wheel Impaktor C Set 1 Socket set, 1/2" drive

Three 1/2" Impaktor socket wrench plug-ins, for use with impact wrenches; with rotating smooth plastic sleeve for higher working speed and additional rim protection. Internal plastic insert to protect the wheel bolt surface.

Wheel Impaktor C Set 1 Socket set, 1/2" drive



Code		EAN		
		4013288		
05004595001	210760			1
		8790 C Wheel Impaktor		
		1x 17,0x85,0x30,0; 1x 19,0x85,0x30,0;		
		1x 21,0x85,0x32,0		

8790 HMC Deep socket with 1/2" drive

Long 1/2" hand and machine socket (ISO 2725 part 3) with ball intercept ring; for external hexagonal bolts and sockets. For use in manual and machine operation (non-impact), even with low-lying screwdriving and protruding threaded rods.

With Take it easy tool finder with colour coding by size - for easy and fast location of the required tool. Easy to grasp even with oily hands.

The hexagon profile allows the transmission of high forces and puts less strain on the edges of bolts or screw heads than a double hexagon profile. Fine-toothed ratchets also make the use of a double hexagon profile superfluous, even in confined spaces, thanks to their small back-pivoting angle.

- Long sockets for low-lying screwdriving, often even with protruding threaded rods in small spaces
- Hexagonal profile enables precise bolting with high power transmission and preserves the profile
- Knurling at lower end to enable easy gripping when used in manual applications
- Made of matt chromed chrome-vanadium

8790 HMC Deep socket with 1/2" drive



Code	EAN	mm	mm	mm	mm	
05004550001	210562	10,0	83,0	15,5	21,8	1
05004551001	210579	11,0	83,0	16,7	22,0	1
05004552001	210586	12,0	83,0	18,0	22,0	1
05004553001	210593	13,0	83,0	19,2	22,0	1
05004554001	210609	14,0	83,0	20,5	22,0	1
05004555001	210616	15,0	83,0	22,0	20,7	1
05004556001	210623	16,0	83,0	22,0	20,7	1
05004557001	210630	17,0	83,0	24,0	22,2	1
05004558001	210647	18,0	83,0	26,0	23,2	1
05004559001	210654	19,0	83,0	26,0	23,2	1
05004560001	210661	20,0	83,0	28,0	25,2	1
05004561001	210678	21,0	83,0	28,0	25,2	1
05004562001	210685	22,0	83,0	30,0	27,2	1
05004563001	210692	24,0	83,0	32,0	28,2	1

Belt C Deep 1 socket set, 1/2" drive

- 6-piece socket set on robust textile belt, 1/2"
- Smooth Twist to Unlock mechanism for a secure fit and simple removal of the sockets
- Long 1/2" socket for low-profile-fitting screw connections in tight construction spaces and for protruding threaded rods
- Hexagonal profile enables precise and profile-preserving screwdriving with high power transmission
- Take it easy tool finder with colour coding according to sizes

Belt C Deep 1 socket set, 1/2" drive



	Code	EAN		
	05004565001	4013288 210708		1
			8790 HMC Deep 1x 10,0x83,0; 1x 13,0x83,0; 1x 15,0x83,0; 1x 16,0x83,0; 1x 17,0x83,0; 1x 19,0x83,0	
			Belt C 0/6 1x 45,0x275,0	
			K30 1x 30,0x200,0	

Magnetic socket rail C Deep 1 socket set, 1/2" drive

Socket rail with 6 long manual and machine sockets (non-impact), 1/2". A smooth rotary mechanism allows a secure hold and easy access of the sockets.

Long 1/2" manual and machine sockets (ISO 2725 part 3) by Wera for manual and (non-impact) machine use even at low lying couplings and protruding thread rods.

With Take it easy tool finder with colour coding by size - to help you find the required tool quickly and easily.

Slip-proof for easy grip even with oily hands. With hexagon profile and ball stop groove.

The hexagon profile enables the transmission of high forces and loads the edges of the bolt or the screw head less than a double hexagon profile.

Fine-teethed ratchets also make use of a double hexagon profile superfluous, even in confined spaces, thanks to their small return angle.

For external hexagon bolts and screws. The rail allows temporary attachment to metallic surfaces and, with its twist-to-unlock function, ensures secure locking and unlocking of the sockets.

- 6-piece socket set on socket rail, 1/2"
- Rail with secure bit mounting and yet easy removal (twist-to-unlock) for temporary attachment on wall, shelf or workshop trolley
- Smooth Twist to Unlock mechanism for a secure fit and simple removal of the sockets
- Long 1/2" socket for low-profile-fitting screw connections in tight construction spaces and for protruding threaded rods
- Hexagonal profile enables precise and profile-preserving screwdriving with high power transmission

Magnetic socket rail C Deep 1 socket set, 1/2" drive

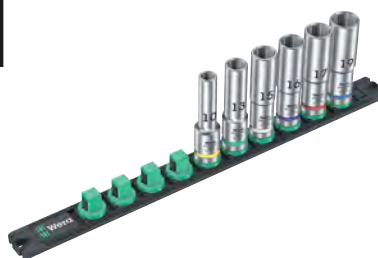
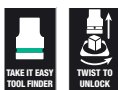

	Code	EAN		
	05005470001	4013288 223272		1
			8790 HMC Deep 1x 10,0x83,0; 1x 13,0x83,0; 1x 15,0x83,0; 1x 16,0x83,0; 1x 17,0x83,0; 1x 19,0x83,0	
			9602 1x 30,0x370,0	



8767 C HF TORX® Zyklop bit socket with 1/2" drive with holding function

- Bit socket (non-impact) for manual or machine tool operations
- The holding function holds screws securely on the tool
- Take it easy tool finder with colour coding according to sizes
- Knurling on lower end for more grip when used manually
- Chrome vanadium steel, matt chrome-plated

8767 C HF TORX® Zyklop bit socket with 1/2" drive with holding function



Code	EAN							
05003830001	183316		TX 20	60,0	16,4	23,5	21,5	1
05003850001	183545		TX 20	140,0	16,4	23,5	101,5	1
05003831001	183323		TX 25	60,0	16,4	23,5	21,5	1
05003851001	183552		TX 25	140,0	16,4	23,5	101,5	1
05003832001	183330		TX 27	60,0	16,4	23,5	21,5	1
05003852001	183569		TX 27	140,0	16,4	23,5	101,5	1
05003833001	183347		TX 30	60,0	16,4	23,5	21,5	1
05003853001	183576		TX 30	140,0	16,4	23,5	101,5	1
05003834001	183354		TX 40	60,0	16,4	23,5	21,5	1
05003854001	183583		TX 40	140,0	16,4	23,5	101,5	1
05003835001	183361		TX 45	60,0	16,4	23,5	21,5	1
05003855001	184443		TX 45	140,0	16,4	23,5	101,5	1
05003836001	183378		TX 50	60,0	21,4	23,5	21,5	1
05003856001	183606		TX 50	140,0	21,4	23,5	101,5	1
05003837001	183385		TX 55	60,0	21,4	23,5	21,5	1
05003857001	183613		TX 55	140,0	21,4	23,5	101,5	1
05003838001	183392		TX 60	60,0	21,4	23,5	21,5	1
05003858001	183620		TX 60	140,0	21,4	23,5	101,5	1

Belt C 3 TORX® HF Zyklop bit socket set with holding function, 1/2" drive

Typically Wera designed robust textile belt with 6 in-hex bit-sockets taking up minimal space. A smooth Twist to Unlock mechanism ensures a secure fit and simple removal of the sockets.

Comes with Take it easy Tool Finder with colour coding according to size to enable the right tool to be selected easily and quickly. Includes a snap hook for secure fastening to a belt loop or pocket.

Supplied with a nonwoven reverse side and hook and loop strips for simple attachment e.g. to a wall, shelf, tool trolley and to the Wera 2go tool transport system.

- 6-piece socket set on robust textile belt, 1/2"
- Bit-sockets with all the advantages of the Wera bit technology
- Bit-sockets with holding function for screws/bolts
- Smooth Twist to Unlock mechanism for a secure fit and simple removal of the sockets
- Suitable for attachment to a wall, shelf, tool trolley and to the Wera 2go System

Belt C 3 TORX® HF Zyklop bit socket set with holding function, 1/2" drive



Code	EAN		
05003997001	204882		1
		8767 C HF 1x TX 25x60,0; 1x TX 30x60,0; 1x TX 40x60,0; 1x TX 45x60,0; 1x TX 50x60,0; 1x TX 55x60,0	
		Belt C 0/6 1x 45,0x275,0	
		K30 1x 30,0x200,0	

Magnetic socket rail C 4 Zyklop socket set, 1/2" drive
 Socket rail with 9 manual and machine sockets (non-impact), 1/2". A smooth rotary mechanism allows a secure hold and easy access of the sockets.

With Take it easy tool finder with colour coding by size - to help you find the required tool quickly and easily.

The rail allows temporary attachment to metallic surfaces and, with its twist-to-unlock function, ensures secure locking and unlocking of the sockets.

- 9-piece socket set on socket rail, 1/2"
- Rail with secure bit mounting and yet easy removal (twist-to-unlock) for temporary attachment on wall, shelf or workshop trolley
- Smooth Twist to Unlock mechanism for a secure fit and simple removal of the sockets
- With Take it easy tool finder: colour coding by size

Magnetic socket rail C 4 Zyklop socket set, 1/2" drive

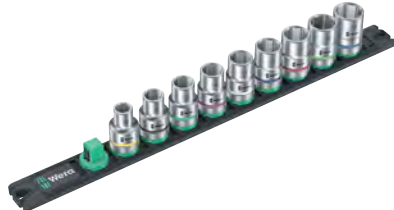

Code	EAN		
05005460001	4013288 223265		1
		● 8790 HMC 1x 10,0x37,0; 1x 12,0x37,0; 1x 13,0x37,0; 1x 14,0x37,0; 1x 15,0x37,0; 1x 16,0x37,0; 1x 17,0x37,0; 1x 18,0x37,0; 1x 19,0x37,0	
		9602 1x 30,0x370,0	

8767 C TORX® HF 1 Zyklop bit socket set with 1/2" drive, with holding function

- Compact textile box with high robustness, low weight and volume

8767 C TORX® HF 1 Zyklop bit socket set with 1/2" drive, with holding function



Code	EAN		
05004202001	4013288 184276		1
		♻️ 8767 C HF 1x TX 20x60,0; 1x TX 25x60,0; 1x TX 27x60,0; 1x TX 30x60,0; 1x TX 40x60,0; 1x TX 45x60,0; 1x TX 50x60,0; 1x TX 55x60,0; 1x TX 60x60,0	

8767 C TORX® HF 2 Zyklop bit socket set with 1/2" drive, with holding function

- Compact textile box with high robustness, low weight and volume
- Long version

8767 C TORX® HF 2 Zyklop bit socket set with 1/2" drive, with holding function



Code	EAN		
05004211001	4013288 185464		1
		♻️ 8767 C HF 1x TX 20x140,0; 1x TX 25x140,0; 1x TX 27x140,0; 1x TX 30x140,0; 1x TX 40x140,0; 1x TX 45x140,0	

8767 C TORX® HF 3 Zyklop bit socket set with 1/2" drive, with holding function

- Compact textile box with high robustness, low weight and volume
- Long version

8767 C TORX® HF 3 Zyklop bit socket set with 1/2" drive, with holding function



Code	EAN		
05004212001	4013288 185471		1
		8767 C HF 1x TX 20x140,0; 1x TX 25x140,0; 1x TX 27x140,0; 1x TX 30x140,0; 1x TX 40x140,0; 1x TX 45x140,0; 1x TX 50x140,0; 1x TX 55x140,0; 1x TX 60x140,0	

8740 C HF Zyklop bit socket with 1/2" drive with holding function

- Bit socket (non-impact) for manual or machine tool operations
- The holding function holds screws securely on the tool
- Take it easy tool finder with colour coding according to sizes
- Knurling on lower end for more grip when used manually
- Chrome vanadium steel, matt chrome-plated

8740 C HF Zyklop bit socket with 1/2" drive with holding function



Code	EAN							
Code	4013288		mm	mm	mm	mm	mm	
05003820001	183217		4,0	60,0	14,0	21,5	21,5	1
05003840001	183484		4,0	140,0	14,0	21,5	101,5	1
05003821001	183224		5,0	60,0	14,0	21,5	21,5	1
05003841001	183491		5,0	140,0	14,0	21,5	101,5	1
05003822001	183231		6,0	60,0	14,0	21,5	21,5	1
05003842001	183507		6,0	140,0	14,0	21,5	101,5	1
05003823001	183248		7,0	60,0	14,0	23,5	21,5	1
05003843001	183514		7,0	140,0	14,0	23,5	101,5	1
05003824001	183255		8,0	60,0	16,0	23,5	21,5	1
05003844001	183521		8,0	140,0	16,0	23,5	101,5	1
05003825001	183262		10,0	60,0	16,0	23,5	21,5	1
05003845001	183538		10,0	140,0	16,0	23,5	101,5	1
05003826001	183279		12,0	60,0	21,0	23,5	23,0	1
05003827001	183286		14,0	60,0	22,0	23,5	23,0	1
05003828001	183293		17,0	60,0	24,5	25,5	23,0	1
05003829001	183309		19,0	60,0	26,5	27,5	23,0	1

Belt C 2 Zyklop In-Hex-Plus bit socket set with holding function, 1/2" drive

Typically Wera designed robust textile belt with 6 in-hex bit-sockets taking up minimal space.

A smooth Twist to Unlock mechanism ensures a secure fit and simple removal of the sockets.

Comes with Take it easy Tool Finder with colour coding according to size to enable the right tool to be selected easily and quickly. Includes a snap hook for secure fastening to a belt loop or pocket.

Supplied with a nonwoven reverse side and hook and loop strips for simple attachment e.g. to a wall, shelf, tool trolley and to the Wera 2go tool transport system.

- 6-piece socket set on robust textile belt, 1/2"
- Bit-sockets with all the advantages of the Wera bit technology
- Bit-sockets with holding function for screws/bolts
- Smooth Twist to Unlock mechanism for a secure fit and simple removal of the sockets
- Suitable for attachment to a wall, shelf, tool trolley and to the Wera 2go System

Belt C 2 Zyklop In-Hex-Plus bit socket set with holding function, 1/2" drive

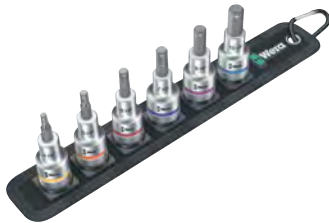

Code	EAN		
05003996001	4013288 204424		1
		○ 8740 C HF 1x 4,0x60,0; 1x 5,0x60,0; 1x 6,0x60,0; 1x 7,0x60,0; 1x 8,0x60,0; 1x 10,0x60,0	
		Belt C 0/6 1x 45,0x275,0	
		K30 1x 30,0x200,0	

8740 C HF 1 Zyklop bit socket set with 1/2" drive, with holding function

- Compact textile box with high robustness, low weight and volume

8740 C HF 1 Zyklop bit socket set with 1/2" drive, with holding function



Code	EAN		
05004201001	4013288 184283		1
		○ 8740 C HF 1x 4,0x60,0; 1x 5,0x60,0; 1x 6,0x60,0; 1x 7,0x60,0; 1x 8,0x60,0; 1x 10,0x60,0; 1x 12,0x60,0; 1x 14,0x60,0; 1x 17,0x60,0	

8740 C HF 2 Zyklop bit socket set with 1/2" drive, with holding function

- Compact textile box with high robustness, low weight and volume
- Long version

8740 C HF 2 Zyklop bit socket set with 1/2" drive, with holding function



Code	EAN		
05004210001	4013288 185457		1
		○ 8740 C HF 1x 4,0x140,0; 1x 5,0x140,0; 1x 6,0x140,0; 1x 7,0x140,0; 1x 8,0x140,0; 1x 10,0x140,0	

8796 LC Zyklop „flexible-lock“ extension with free-turning sleeve, long, 1/2"

- For 1/2" square sockets with ball lock
- Flexible lock system for either locking or rapid exchange of the attached tool
- With free-turning sleeve for rapid tightening and loosening of screws and nuts

8796 LC Zyklop „flexible-lock“ extension with free-turning sleeve, long, 1/2"



Code	EAN	□	⌀						
05003643001	121462	1/2"	250,0						1

8796 SC Zyklop „flexible-lock“ extension with free-turning sleeve, short, 1/2"

- For 1/2" square sockets with ball lock
- Flexible lock system for either locking or rapid exchange of the attached tool
- With free-turning sleeve for rapid tightening and loosening of screws and nuts

8796 SC Zyklop „flexible-lock“ extension with free-turning sleeve, short, 1/2"



Code	EAN	□	⌀						
05003642001	121455	1/2"	125,0						1

8794 LC Zyklop extension with free-turning sleeve, long, 1/2"

Wera Zyklop extension with easy-to-grip free-turning sleeve for rapid tightening and loosening of screws and nuts. Out of high quality chrome vanadium steel, matt chrome-plated.

8794 LC Zyklop extension with free-turning sleeve, long, 1/2"



Code	EAN	□	⌀						
05003638001	121431	1/2"	250,0						1

8794 SC Zyklop extension with free-turning sleeve, short, 1/2"

Wera Zyklop extension with easy-to-grip free-turning sleeve for rapid tightening and loosening of screws and nuts. Out of high quality chrome vanadium steel, matt chrome-plated.

8794 SC Zyklop extension with free-turning sleeve, short, 1/2"



Code	EAN	□	⌀						
05003637001	121424	1/2"	125,0						1

8789 C Zyklop sliding T-handle, 1/2"

Wera Zyklop T-handle for higher torque transfer. For 1/2" square sockets with ball lock. Adjustable drive for more flexible usage. Out of high quality chrome vanadium steel, matt chrome-plated.

8789 C Zyklop sliding T-handle, 1/2"



Code	EAN	Socket	Length	Weight	Volume	Unit
05003636001	121530	1/2"	250,0			3

8795 C Zyklop universal joint, 1/2"

Wera Zyklop universal joint for 1/2" square sockets with ball lock.

8795 C Zyklop universal joint, 1/2"



Code	EAN	Socket	Length	Weight	Volume	Unit
05003640001	121547	1/2"	69,0			1

8794 C Zyklop wobble extension, 1/2"

Wobble extension for the Wera Zyklop. Swivel angle of 15° in all directions. This ensures rapid and precise work even in confined working situations.

8794 C Zyklop wobble extension, 1/2"



Code	EAN	Socket	Length	Weight	Volume	Unit
05003639001	121448	1/2"	52,0			1

8784 C2 Zyklop bit adaptor, 1/2", 5/16"

Adaptor from square to hex. For 5/16" hex bits as per DIN ISO 1173-C 8 and Wera connecting series 2; with quick-release chuck.

8784 C2 Zyklop bit adaptor, 1/2", 5/16"



Code	EAN	Hex Size	Socket	Length	Weight	Volume
05003641001	119353	5/16"	1/2"	50,0		1

8009 Zyklop Pocket Set 1

Compact Zyklop ratchet with bit magazine for the pocket. Magnetic direct mounting for 1/4" bits and 3/8" sockets. Rapid tool change thanks to the non-locking mounting.

As the head is lockable at 0°, 15° and 90°, the tool can be used as a ratchet and as a ratchet screwdriver. The fine toothed ratchet with 72 teeth allows for a low return angle of 5°.

Wide range of applications thanks to 12 bits integrated in the handle. The robust ratchet mechanism allows for ample torque. Perfect combination of a Zyklop ratchet with a 12-piece screwdriver set.

- Compact Zyklop ratchet with integrated bit magazine
- Thanks to its clever design the ratchet head doubles up as both a 3/8" square drive ratchet for sockets, and integral 1/4" hexagon drive for screwdriver bits
- Freely pivoting ratchet head with 5 predefined locking positions
- Fine toothed ratchet (72 teeth) for a low return angle of only 5°
- Captive and freely swivelling bit magazine for easy removal and secure storage of the bits

8009 Zyklop Pocket Set 1



Code	EAN		
05004280001	4013288 221834		1
		8009 1x 3/8"x1/4"x133,0	
		851/1 BTZ 1x PH 1x25; 1x PH 2x25	
		855/1 BTZ 1x PZ 1x25; 1x PZ 2x25	
		867/1 TORX® BTZ 1x TX 10x25; 1x TX 15x25; 1x TX 20x25; 1x TX 25x25	
		840/1 BTZ 1x 3,0x25; 1x 4,0x25; 1x 5,0x25; 1x 6,0x25	

8009 Zyklop Pocket Imperial Set 1



Code	EAN		
05004282001	4013288 221841		1
		8009 1x 3/8"x1/4"x133,0	
		851/1 BTZ 1x PH 1x25; 1x PH 2x25	
		867/1 TORX® BTZ 1x TX 10x25; 1x TX 15x25; 1x TX 20x25; 1x TX 25x25	
		840/1 Z 1x 1/8"x25; 1x 5/32"x25; 1x 3/16"x25; 1x 1/4"x25	
		868/1 Z 1x # 1x25; 1x # 2x25	

8009 Zyklop Pocket Set 2

Compact Zyklop ratchet with bit magazine for the pocket. Magnetic direct mounting for 1/4" bits and 3/8" sockets. Rapid tool change thanks to the non-locking mounting. As the head is lockable at 0°, 15° and 90°, the tool can be used as a ratchet and as a ratchet screwdriver.

The fine toothing with 72 teeth allows for a low return angle of 5°. Wide range of applications thanks to 12 bits integrated in the handle. The robust ratchet mechanism allows for ample torque. Perfect combination of a Zyklop ratchet with a 12-piece screwdriver set.

The 75 mm long universal holder for 1/4" bits can be used as an extension. Including sockets in the commonest dimensions. One robust textile holster 9468 to be attached to the belt and docked onto the Wera 2go system.

- Compact Zyklop ratchet with integrated bit magazine
- The magnetic direct mounting simultaneously turns the 3/8" ratchet into a bit ratchet screwdriver with 1/4" bit mounting
- Freely pivoting ratchet head with 5 predefined locking positions
- Fine tooth reversible ratchet (72 teeth) for a low return angle of only 5°
- Captive and freely swivelling bit magazine for easy removal and secure storage of the bits
- Universal holder with stainless steel sleeve and strong permanent magnet, can be used as extension
- Robust textile holster to be attached to the belt and docked onto the Wera 2go system

8009 Zyklop Pocket Set 2



Code	EAN		
	4013288		
05004281001	223050		1
		8009 1x 3/8"x1/4"x133,0	
		893/1/1 1x 1/4"x75	
		851/1 BTZ 1x PH 1x25; 1x PH 2x25	
		855/1 BTZ 1x PZ 1x25; 1x PZ 2x25	
		867/1 TORX® BTZ 1x TX 10x25; 1x TX 15x25; 1x TX 20x25; 1x TX 25x25	
		840/1 BTZ 1x 3,0x25; 1x 4,0x25; 1x 5,0x25; 1x 6,0x25	
		8790 HMB 1x 8,0x29,0; 1x 10,0x29,0; 1x 13,0x29,0	
		9468 1x 155,0x65,0	
		Hook and Loop Fastener Strip 70 1x 50,0x70,0	

8009 Zyklus Pocket Imperial Set 2



Code	EAN		
05004283001	4013288 223067		1
		<ul style="list-style-type: none"> <input type="checkbox"/> 8009 1x 3/8"x1/4"x133,0 <input checked="" type="checkbox"/> 893/1/1 1x 1/4"x75 <input checked="" type="checkbox"/> 851/1 BTZ 1x PH 1x25; 1x PH 2x25 <input checked="" type="checkbox"/> 867/1 TORX® BTZ 1x TX 10x25; 1x TX 15x25; 1x TX 20x25; 1x TX 25x25 <input type="checkbox"/> 840/1 Z 1x 1/8"x25; 1x 5/32"x25; 1x 3/16"x25; 1x 1/4"x25 <input type="checkbox"/> 868/1 Z 1x # 1x25; 1x # 2x25 <input checked="" type="checkbox"/> 8790 HMB 1x 5/16"x29,0; 1x 3/8"x29,0; 1x 1/2"x29,0 	
		9468 1x 155,0x65,0	
		Hook and Loop Fastener Strip 70 1x 50,0x70,0	

Koloss - this ratchet is the best!



The ratchet that can also be safely and officially used as a hammer. The Koloss is a reversible, heavy-duty ratchet that can be used with a load of at least 600 Newton metres. The dual ratchet teeth and the minimum return angle of only 6° ensure rapid and precise screwdriving even in confined situations.

And the best thing: absolutely no impact on the hammer faces, however hard, can destroy the ratchet mechanism.

Multi-component Kraftform handle optimised to withstand pressure, impact and tensile loads; take-up for Koloss extension 8780 C and Koloss centring pin 8781 C at end of handle. Also included in the set: 1 pad to protect materials and surface areas, 1 Koloss extension for the transfer of even more torque, 1 unlocking pin and 1 holster – so the Koloss can always be at hand.

- For loads of at least 600 Newton metres
- Push-through square drive for right/left switchover
- Including hammer function
- Multi-component Kraftform handle optimised to withstand pressure, impact and tensile loads
- Fine-pitched ratchet mechanism, small return angle of 6°

8002 C Koloss All Inclusive Set with 1/2" drive



Code	EAN		
05133862001	4013288 162403		1
		8002 C 1x 1/2"x341,0	
		8782 C 1x 2x50,0	
		8780 C 1x 341,0x137	
		8000 E 1x 40,5	
		8000 HLF 1x 175,0x75,0	

9602 Magnetic socket rail, 1/2", empty

1 socket rail, empty. For up to 10 sockets and/or bit sockets with 1/2" drive.

The rail allows temporary attachment to metallic surfaces and, with its twist-to-unlock function, ensures secure locking and unlocking of the sockets.

- Rail with secure bit mounting and yet easy removal (twist-to-unlock) for temporary attachment on wall, shelf or workshop trolley
- Smooth Twist to Unlock mechanism for a secure fit and simple removal of the sockets
- Empty, for up to 10 sockets, 1/2"

9602 Magnetic socket rail, 1/2", empty

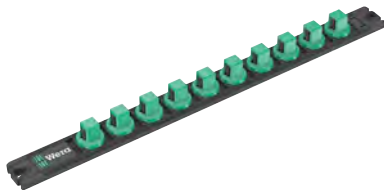

Code	EAN	mm	mm						
05136422001	223340	30,0	370,0						1

Socket rail C Impaktor (textile belt), 9 location, unloaded



Code	EAN								
05003893001	211484								1
		Belt C Impaktor 0/9 1x 71,0x210,0							
		K30 1x 30,0x200,0							

Zyklop Mini - beauty in strength

Zyklop Mini 1 & 2
Fine tooth mechanism (60 teeth), small return angle of only 6° – ideal for precision work.

Zyklop Mini 1 & 2
Its slim design makes it ideal for all particularly confined working situations.

Zyklop Mini 1
Thumbwheel for rapid fastening.

Zyklop Mini 2
The Zyklop Mini 2 is suitable for the direct attachment of the special Wera Zyklop sockets 8790 FA. These sockets feature a very low height, ideal for confined working spaces.

Zyklop Mini 1 & 2
Easy switching between left/right operations.



Wera Zyklop Mini 1: a symbiosis of strength and stylishness. Incredibly robust due to its drop-forged, full-steel design. Can withstand torque forces up to 65 Nm.

The petite sizing is particularly suited for work in confined spaces. The thumbwheel allows fast screwdriving. Comes in a set in the proven Wera Bit-Check with socket adaptor and belt clip. Simple tool removal and reinsertion is ensured, very robust and durable.

- Bit-Checks convince due to their functionality in a minimum of space
- Wera Mini ratchet for particularly fast screwdriving even in confined spaces
- Ideal for working in confined spaces
- Tough viscous bits for universal use
- In handy and robust Bit-Check

Bit-Check 30 Zyklop Mini 1



Code	EAN		
05073640001	144652		1
		8001 A 1x 1/4"x87,0	
		870/1 1x 1/4"x25 ¹⁾	
		889/4/1 K 1x 1/4"x50	
		851/1 TZ PH 2x PH 1x25; 3x PH 2x25; 1x PH 3x25	
		855/1 TH PZ 1x PZ 1x25; 3x PZ 2x25; 1x PZ 3x25	
		867/1 TZ TORX® 1x TX 10x25; 1x TX 15x25; 1x TX 20x25; 1x TX 25x25; 1x TX 30x25; 1x TX 40x25	
		867/1 Z TORX® B0 1x TX 10x25; 1x TX 15x25; 1x TX 20x25; 1x TX 25x25; 1x TX 30x25	
		800/1 TZ 1x 1,0x5,5x25	
		840/1 Z Hex-Plus 1x 3,0x25; 1x 4,0x25; 1x 5,0x25; 1x 6,0x25; 1x 8,0x25	

¹⁾With friction ball; for manual nut spinner sockets

Bit-Check 30 Zyklop Mini 2



Code	EAN		
05346293001	145765		1
		8001 A 1x 1/4"x87,0	
		889/4/1 K 1x 1/4"x50	
		870/1 1x 1/4"x25 ¹⁾	
		851/1 TZ PH 2x PH 1x25; 3x PH 2x25; 1x PH 3x25	
		867/1 TZ TORX® 1x TX 10x25; 1x TX 15x25; 1x TX 20x25; 1x TX 25x25; 1x TX 30x25; 1x TX 40x25	
		867/1 Z TORX® B0 1x TX 10x25; 1x TX 15x25; 1x TX 20x25; 1x TX 25x25; 1x TX 30x25	
		840/1 Z Hex-Plus 1x 3/32"x25; 1x 1/8"x25; 1x 5/32"x25; 1x 3/16"x25; 1x 1/4"x25	
		800/1 TZ 1x 1,0x5,5x25	
		868/1 Z 1x # 1x25; 3x # 2x25; 1x # 3x25	

¹⁾With friction ball; for manual nut spinner sockets

Kraftform Kompakt Zyklus Mini 2

Ratchets and screws in a Kraftform Kompakt format. These drop-forged, full-steel ratchets, Zyklus Mini 1 and 2, combine filigree design with incredible robustness.

For particularly rapid screwdriving in confined working situations. Zyklus Mini 1 or Zyklus Mini 2 can be used whenever screwdriving with power tools or conventional hand tools is unfeasible for lack of space. 1 bit ratchet Zyklus Mini 1; suitable for the take-up of bits with 1/4" hexagon head drive as per DIN ISO 1173-C 6.3 and E 6.3 and Wera connecting series 1 and 4; also possible to use 1/4" sockets by attaching the Wera adaptor 870/1. 1 socket ratchet Zyklus Mini 2; suitable for the direct attachment of Wera Zyklus special sockets 8790 FA.

Kraftform Kompakt Zyklus Mini 2



Code	EAN		
05135918001	4013288 182180		1
		8001 A 1x 1/4"x87,0	
		8005 1x 107	
		813 1x 1/4"x78	
		870/1 1x 1/4"x25 ¹⁾	
		851/1 Z PH 1x PH 1x25; 1x PH 2x25	
		855/1 Z PZ 1x PZ 1x25; 1x PZ 2x25	
		867/1 TORX® 1x TX 10x25; 1x TX 15x25; 1x TX 20x25; 1x TX 25x25; 1x TX 30x25; 1x TX 40x25	
		840/1 Z Hex-Plus 1x 3,0x25; 1x 4,0x25; 1x 5,0x25; 1x 6,0x25	
		8790 FA 1x 4,0; 1x 5,0; 1x 5,5; 1x 6,0; 1x 7,0; 1x 8,0; 1x 10,0; 1x 12,0; 1x 13,0	

¹⁾With friction ball; for manual nut spinner sockets

Tool-Check PLUS

Combination tool consisting of a ratchet, bits, sockets and holder in a minimum of space. Ideal as a universal companion for a whole host of screwdriving applications. High quality bit holder with Kraftform Plus handle for pleasant, ergonomic working that prevents blisters and calluses. Hard gripping zones for high working speeds whereas soft zones ensure high torque transfer. Mini ratchet for rapid working when fastening jobs with a power tool or conventional hand tools are not feasible due to insufficient space. Rapid changeover from left to right direction and vice versa by using the switchover lever. Fast work possible by turning the thumbwheel (with the thumb) on the ratchet head. Simplest operation even with just one hand. Ergonomic ratchet head/lever: Kraftform geometry with perfectly shaped contact areas for the fingers.

The direct bit take-up in the ratchet head makes for a mini tool design and is ideal for low working heights. The small return angle of 6° allows for precise work. Robust drop-forged, full steel design. Torque of over 65 Nm.

The Rapidaptor bit holder with free-turning sleeve: can be used as an extension; for rapid bit change without any special tools – even the very smallest bits with just a single hand. Tough viscous bits for universal use. Sockets for both manual as well as power tool operations for almost all applications.

Take it easy Tool Finder with colour coding according to size - for simple and rapid accessing of the required tool. Featuring a good grip to allow easy pick-up even with oily hands. Ball stop groove, for hex head bolts and nuts; chrome vanadium steel, matt chrome-plated.

Tool-Check PLUS



Code	EAN		
	4013288		
05056490001	173003		1
		8001 A 1x 1/4"x87,0	
		813 1x 1/4"x78	
		889/4/1 K 1x 1/4"x50	
		870/1 1x 1/4"x25 ¹⁾	
		8790 HMA 1x 5,5x23,0; 1x 6,0x23,0; 1x 7,0x23,0; 1x 8,0x23,0; 1x 10,0x23,0; 1x 12,0x23,0; 1x 13,0x23,0	
		851/1 TZ PH 2x PH 1x25; 3x PH 2x25; 1x PH 3x25	
		855/1 TH PZ 1x PZ 1x25; 3x PZ 2x25; 1x PZ 3x25	
		867/1 TZ TORX® 1x TX 10x25; 1x TX 15x25; 1x TX 20x25; 1x TX 25x25; 1x TX 30x25; 1x TX 40x25	
		867/1 Z TORX® BO 1x TX 10x25; 1x TX 15x25; 1x TX 20x25; 1x TX 25x25; 1x TX 30x25	
		840/1 Z Hex-Plus 1x 3,0x25; 1x 4,0x25; 1x 5,0x25; 1x 6,0x25; 1x 8,0x25	
		800/1 TZ 1x 1,0x5,5x25	

¹⁾With friction ball; for manual nut spinner sockets

Tool-Check PLUS Imperial



Code	EAN		
	4013288		
05056491001	178756		1
		8001 A 1x 1/4"x87,0	
		813 1x 1/4"x78	
		889/4/1 K 1x 1/4"x50	
		870/1 1x 1/4"x25 ¹⁾	
		8790 HMA 1x 3/16"x23,0; 1x 1/4"x23,0; 1x 5/16"x23,0; 1x 11/32"x23,0; 1x 3/8"x23,0; 1x 7/16"x23,0; 1x 1/2"x23,0	
		851/1 TZ PH 2x PH 1x25; 3x PH 2x25; 1x PH 3x25	
		800/1 TZ 1x 1,0x5,5x25	
		867/1 TZ TORX® 1x TX 10x25; 1x TX 15x25; 1x TX 20x25; 1x TX 25x25; 1x TX 30x25; 1x TX 40x25	
		867/1 Z TORX® BO 1x TX 10x25; 1x TX 15x25; 1x TX 20x25; 1x TX 25x25; 1x TX 30x25	
		840/1 Z Hex-Plus 1x 3/32"x25; 1x 1/8"x25; 1x 5/32"x25; 1x 3/16"x25; 1x 7/16"x25	
		868/1 V 1x # 1x25; 3x # 2x25; 1x # 3x25	

¹⁾With friction ball; for manual nut spinner sockets

Tool-Check 1 SB

- 1/4" bit ratchet, tough-absorbing bits, Rapidaptor holder, adaptor and 1/4" sockets
- Ideal for working in confined spaces
- Tough viscous bits for universal use
- Use of 1/4" sockets also possible with the Wera adaptor 870/1
- Take it easy tool finder: colour coding according to profile and size

Tool-Check 1 SB



Code	EAN		
05073220001	162526		1
		8001 A 1x 1/4"x87,0	
		870/1 1x 1/4"x25 ¹⁾	
		889/4/1 K 1x 1/4"x50	
		851/1 TZ PH 2x PH 1x25; 3x PH 2x25; 1x PH 3x25	
		855/1 TH PZ 1x PZ 1x25; 3x PZ 2x25; 1x PZ 3x25	
		867/1 TZ TORX® 1x TX 10x25; 1x TX 15x25; 1x TX 20x25; 1x TX 25x25; 1x TX 30x25; 1x TX 40x25	
		867/1 Z TORX® BO 1x TX 10x25; 1x TX 15x25; 1x TX 20x25; 1x TX 25x25; 1x TX 30x25	
		800/1 TZ 1x 1,0x5,5x25	
		840/1 Z Hex-Plus 1x 3,0x25; 1x 4,0x25; 1x 5,0x25; 1x 6,0x25; 1x 8,0x25	
		8790 HMA 1x 5,5x23,0; 1x 6,0x23,0; 1x 7,0x23,0; 1x 8,0x23,0; 1x 10,0x23,0; 1x 12,0x23,0; 1x 13,0x23,0	

¹⁾With friction ball; for manual nut spinner sockets

Tool-Check Automotive 1



Code	EAN		
05200995001	165343		1
		8001 A 1x 1/4"x87,0	
		870/1 1x 1/4"x25 ¹⁾	
		889/4/1 K 1x 1/4"x50	
		851/1 TZ PH 1x PH 1x25; 1x PH 2x25; 1x PH 3x25	
		867/1 TZ TORX® 1x TX 10x25; 1x TX 15x25; 1x TX 20x25; 1x TX 25x25; 1x TX 30x25; 1x TX 40x25	
		867/1 Z TORX® BO 1x TX 10x25; 1x TX 15x25; 1x TX 20x25; 1x TX 25x25; 1x TX 30x25	
		800/1 TZ 1x 1,0x5,5x25	
		840/1 Z Hex-Plus 1x 3,0x25; 1x 4,0x25; 1x 5,0x25; 1x 6,0x25; 1x 8,0x25	
		860/1 Z XZN 1x M 4x25; 1x M 5x25; 1x M 6x25; 1x M 8x25	
		873/1 Five Lobe 1x 20x25; 1x 25x25; 1x 27x25; 1x 30x25	
		8790 HMA 1x 5,5x23,0; 1x 6,0x23,0; 1x 7,0x23,0; 1x 8,0x23,0; 1x 10,0x23,0; 1x 12,0x23,0; 1x 13,0x23,0	

¹⁾With friction ball; for manual nut spinner sockets

Bit-Check 10 Zyklop Mini BiTorsion 1

Many tools in a minimum of space. The sorting according to drive and size allows rapid accessing of the bits.

The Wera Mini ratchet: drop-forged, full-steel design. Fine-pitched mechanism with 60 teeth that allows a small return angle of only 6° for precise work. Simple left/right switchover. Ergonomically-designed ratchet head and lever.

- 1/4" Mini ratchet and tough viscous bits

Bit-Check 10 Zyklop Mini BiTorsion 1



Code	EAN		
05057418001	4013288 195951		1
		8001 A 1x 1/4"x87,0	
		851/1 BTZ PH 1x PH 1x25; 1x PH 2x25	
		855/1 BTZ PZ 1x PZ 1x25; 1x PZ 2x25	
		867/1 TORX® BTZ 1x TX 15x25; 1x TX 20x25; 1x TX 25x25	
		840/1 BTZ Hex-Plus 1x 4,0x25; 1x 5,0x25	

Bit-Check 10 Zyklop Mini 1

Many tools in a minimum of space. The sorting according to drive and size allows rapid accessing of the bits. The Wera Mini ratchet: drop-forged, full-steel design.

Fine-pitched mechanism with 60 teeth that allows a small return angle of only 6° for precise work. Simple left/right switchover. Ergonomically-designed ratchet head and lever.

- Tough viscous bits for universal use

Bit-Check 10 Zyklop Mini 1

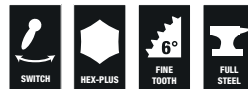

Code	EAN		
05073645001	4013288 168115		1
		8001 A 1x 1/4"x87,0	
		851/1 Z PH 1x PH 1x25; 1x PH 2x25	
		855/1 Z PZ 1x PZ 1x25; 1x PZ 2x25	
		867/1 TORX® 1x TX 15x25; 1x TX 20x25; 1x TX 25x25	
		840/1 Z Hex-Plus 1x 4,0x25; 1x 5,0x25	



Bicycle Set 1

Bicycle repair shops and passionate cyclists love screwdriving on a bicycle. With their Bicycle Set 1, the screwdriving tool specialist Wera offers an assortment of tools that is very mobile thanks to its compact and design-oriented textile folding bag, and offers solutions for the most common screwdriving situations when working with bicycles.

The sturdy bag contains the bit ratchet Zyklop Mini 1 and 10 bits with all the benefits of Wera-Bit technology, specially adapted to the most common screw connections on a bicycle.

With the glass fibre reinforced plastic tyre levers, the tyres can be safely levered off the rim without damaging the rim.

- Compact 14-piece screwdriving tool set for bicycle applications, also for mobile use
- Practical range for DIY assembly work and repairs
- Suitable tools for the most common bolt profiles on road bikes, mountain bikes and e-bikes
- Robust, surface-friendly, compact textile folding bag
- Set including Mini bit ratchet, extension and two tyre levers with additional functions

Bicycle Set 1



Code	EAN		
05004170001	4013288 207623		1
		8001 A 1x 1/4"x87,0	
		3899/4/1 1x 1/4"x100	
		851/1 Z PH 1x PH 2x25	
		867/1 TORX® 1x TX 10x25; 1x TX 25x25	
		840/1 Z Hex-Plus 1x 2,0x25; 1x 2,5x25; 1x 3,0x25; 1x 4,0x25; 1x 5,0x25; 1x 6,0x25; 1x 8,0x25	
		9502 1x 105.0	
		9503 1x 105.0	
		K70 1x 50,0x70,0	

Bicycle Set 3

Bicycle tool set with ratchet, bit, sockets and a bit hand holder in a compact space. Perfect as a universal companion with a variety of screwdriving challenges.

High quality bit hand-holder with Kraftform Plus handle for comfortably ergonomic work, which avoids blisters and calluses. Hard grip zones for high working speed, soft grip zones for high torque transmission.

Bit ratchet for quick work when bolting by machine or by conventional hand tool is not possible due to lack of space. Fast switching from left to right and vice versa via the switching lever.

Quick turning (by thumb) over the grooved ratchet head. Simplest operation even with just one hand.

Ergonomic ratchet head/lever: Kraftform geometry with perfectly shaped contact surfaces for fingers.

The direct bit holder in the ratchet head and the smallest tool design allow for low working heights. Small return angle of 6° for precise work. Robust drop forged full steel design.

Torques of over 65 Nm. The Rapidaptor bit holder with quick-turn coating can be used as an extension, for lightning-fast bit changes with only one hand without auxiliary tools of even the smallest bit sizes.

Tough bits, for universal use. Hand and machine sockets for almost all applications.

With "Take it easy" tool finder with colour coding by size - for easy and fast location of the required tool. Easy to grasp even with oily hands. With ball-catching groove.

For external hexagonal bolts and sockets. Made of matt-chromed chrome-vanadium.

- Compact 41-piece screwdriving tool set for bicycle operations, also for mobile use
- Practical range for DIY assembly work and repairs
- Tools for the most popular screw profiles on road bikes, mountain bikes and e-bikes
- With Take it easy tool finder: colour coding by size
- Robust, surface-friendly, compact low weight textile pouch
- Including two tyre levers with additional functions

Bicycle Set 3



Code	EAN		
05004172001	4013288 211248		1
		8001 A 1x 1/4"x87,0	
		813 1x 1/4"x78	
		889/4/1 K 1x 1/4"x50	
		870/1 1x 1/4"x25 ¹⁾	
		8790 HMA 1x 5,5x23,0; 1x 6,0x23,0; 1x 7,0x23,0; 1x 8,0x23,0; 1x 10,0x23,0; 1x 13,0x23,0; 1x 15,0x23,0	
		851/1 TZ PH 1x PH 1x25; 2x PH 2x25; 1x PH 3x25	
		867/1 TZ TORX® 1x TX 10x25; 1x TX 15x25; 2x TX 20x25; 2x TX 25x25; 1x TX 27x25; 1x TX 30x25; 1x TX 40x25	
		800/1 TZ 1x 0,5x4,0x25; 1x 0,6x4,5x25; 1x 1,0x5,5x25	
		840/1 Z Hex-Plus 1x 2,0x25; 1x 2,5x25; 1x 3,0x25; 1x 4,0x25; 1x 5,0x25; 1x 6,0x25; 1x 8,0x25	
		842/1 Z 1x 2,5x25; 1x 3,0x25; 1x 4,0x25; 1x 5,0x25; 1x 6,0x25	
		9502 1x 105.0	
		9503 1x 105.0	
		K120 1x 50,0x120,0	

¹⁾With friction ball; for manual nut spinner sockets

Bicycle Set 9

A lot of bicycle tools in a small space. The sorting of the 9 stainless steel bits by profile and size allows quick access to the right tool. With one Wera Zyklop Mini 1 bit ratchet in a drop-forged solid steel design.

The fine toothing mechanism with 60 teeth allows a small return angle of 6° for precise working. The knurl allows fast screwdriving in cramped situations, when there is no space for ratcheting. Easy left/right switching.

Ergonomically shaped ratchet head and lever. With Take it easy tool finder with colour coding by size - to help you find the required tool quickly and easily.

- 10-piece Zyklop Mini set
- Mini ratchet suitable for direct mounting of 1/4" nuts
- Drop-forged full steel design for torques exceeding 65 Nm
- Fine-pitched ratchet mechanism and small return angle of 6°
- Stainless Steel Bits



Bicycle Set 9



Code	EAN		
05004177001	4013288 220646		1
		8001 A 1x 1/4"x87,0	
		3851/1 TS PH 1x PH 2x25	
		3867/1 TS TORX® 1x TX 10x25; 1x TX 25x25	
		3840/1 TS 1x 2,0x25; 1x 2,5x25; 1x 3,0x25; 1x 4,0x25; 1x 5,0x25; 1x 6,0x25	

8008 A Zyklop Mini 3 Ratchet with 1/4" drive

The Wera Zyklop Mini 3 ratchet for 1/4" sockets. Simplest operation even with just one hand in confined screwdriving challenges. Drop-forged full steel design.

Fine tooth mechanism with 60 teeth allows a small return angle of 6° for precise work.

The knurled wheel allows fast screwdriving in tight spaces when there is no room for ratcheting. Simple left/right switching. Ergonomically shaped ratchet head and lever.

- Mini ratchet suitable for direct mounting of 1/4" nuts
- Drop-forged full steel design for torques exceeding 65 Nm
- Fine-pitched ratchet mechanism and small return angle of 6°
- Simple left/right switchover
- Ideal for working in confined spaces

8008 A Zyklop Mini 3 Ratchet with 1/4" drive



	EAN								
Code	4013288		mm						
05003793001	211699	1/4"	87,0						1

8790 FA Zyklop socket with 1/4" and Hexagon 11 drive

Zyklop socket with 1/4" and hex drive for manual jobs with a 1/4" ratchet.

8790 FA Zyklop socket with 1/4" and Hexagon 11 drive



	EAN							
Code	4013288	mm	mm	mm	mm	mm		
05003665001	179623	4,0	9,5	6,4	11,8	18,0		1
05003666001	179630	4,5	9,5	7,0	11,8	18,0		1
05003667001	179647	5,0	9,5	7,6	11,8	18,0		1
05003668001	179654	5,5	9,5	8,2	11,8	18,0		1
05003669001	179661	6,0	9,5	9,2	11,8	18,0		1
05003670001	183408	7,0	9,5	10,4	11,8	18,0		1
05003675001	179678	8,0	9,5	11,5	11,8	18,0		1
05003690001	179685	10,0	9,5	13,8	11,8	18,0		1
05003684001	183415	12,0	9,5	16,8	11,8	18,0		1
05003685001	179692	13,0	9,5	17,8	11,8	18,0		1





Joker Wrenches & Spanners



Joker - Can.Do.Everything.Better.



High quality, metric, combination ratchet wrench by Wera. Everything that a wrench has to be able to do. And a whole lot more. Faster, better, stylish. Yes, a real Joker. The new generation of combination ratchet wrenches.

Suitable for hexagon socket screws, bolts or nuts. Comes with holding function, thanks to the metal plate in the jaw, which reduces the risk of dropping nuts and bolts. The replaceable metal plate in the jaw secures nuts and bolts with its extra hard teeth and reduces the danger of slipping.

The integrated limit stop prevents any slipping around the bolt head and allows higher torque to be applied. The double-hex geometry makes for a positive connection with nuts or bolts and reduces the risk of slipping. A return angle of only 30° at the open end prevents any time consuming flipping of the wrench. The ratchet mechanism at the ring end, with an exceptional, fine-tooth mechanism – 80 teeth in all – enables flexibility even in very confined working spaces.

The specially forged geometry ensures high torque transfer and strength. The ratchet is manufactured out of high performance chrome molybdenum steel with nickel-chrome coating for high corrosion protection. Take it easy Tool Finder with colour coding according to sizes.

- Practical holding function thanks to the metal plate in the jaw
- Limit stop prevents any slipping
- The double-hex geometry reduces the risk of slipping
- Return angle of only 30°
- Take it easy tool finder with colour coding according to sizes

6000 Joker Ratcheting combination wrenches



Code	EAN	mm	mm	mm	mm	mm	mm	
05073268001	167309	8	144	20	5,5	18	3	
05073270001	164360	10	159	22	5,5	21	3	
05073271001	167316	11	165	25	6,3	22	3	
05073272001	167323	12	170,7	26,3	6,6	25	3	
05073273001	164377	13	177	27,3	7	25	3	
05073274001	167330	14	188	29,3	7,5	28	3	
05073275001	167347	15	200	32,3	7,8	28,5	3	
05073276001	167392	16	212	35	8,2	32,7	3	
05073277001	164384	17	224	37,2	8,5	32,7	3	
05073278001	167408	18	235	39	9	33,8	3	
05073279001	164391	19	246	42	9,5	34,8	3	

6000 Joker Ratcheting combination wrenches, Imperial



Code	EAN		mm	mm	mm	mm	mm	
05073280001	167354	5/16"	144	20	5,5	18	3	
05073281001	167361	3/8"	159	22	5,5	21	3	
05073282001	167378	7/16"	165	25	6,3	22	3	
05073283001	167385	1/2"	177	27,3	7	25	3	
05073284001	167415	9/16"	188	29,3	7,5	28	3	
05073285001	167422	5/8"	212	35	8,2	32,7	3	
05073286001	167439	11/16"	235	39	9	33,8	3	
05073287001	167446	3/4"	246	42	9,5	34,8	3	

6000 Joker 11 Set 1 of ratcheting combination wrenches

- In robust pouch

6000 Joker 11 Set 1 of ratcheting combination wrenches



	Code	EAN		
	05020013001	167521		1
			6000 Joker 1x 8x144; 1x 10x159; 1x 11x165; 1x 12x170,7; 1x 13x177; 1x 14x188; 1x 15x200; 1x 16x212; 1x 17x224; 1x 18x235; 1x 19x246	

6000 Joker 8 Imperial Set 1 Set of ratcheting combination wrenches, Imperial

- In robust pouch

6000 Joker 8 Imperial Set 1 Set of ratcheting combination wrenches, Imperial

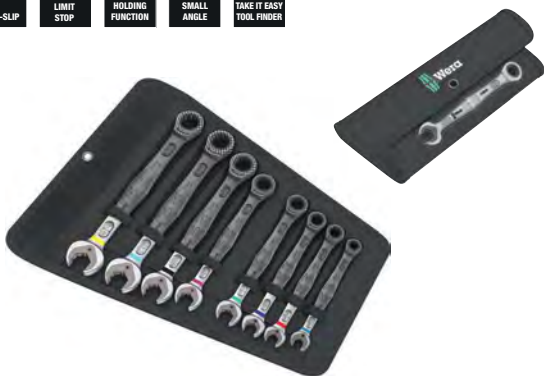

	Code	EAN		
	05020012001	167514		1
			6000 Joker Imperial 1x 5/16"x144; 1x 3/8"x159; 1x 7/16"x165; 1x 1/2"x177; 1x 9/16"x188; 1x 5/8"x212; 1x 11/16"x235; 1x 3/4"x246	

6000/6002 Joker 6 Set 1 Set of ratcheting combination / double open-ended wrenches

- The Joker double open-ended wrench is ideally suited for locking down nuts and bolts.
- In robust pouch

6000/6002 Joker 6 Set 1 Set of ratcheting combination / double open-ended wrenches



	Code	EAN		
	05020022001	173034		1
			6000 Joker 1x 10x159; 1x 13x177; 1x 17x224; 1x 19x246	
			6002 Joker Double 1x 10x13x167; 1x 17x19x235	

6000 Joker 4 Set 1 Set of ratcheting combination wrenches

- In robust pouch

6000 Joker 4 Set 1 Set of ratcheting combination wrenches



	Code	EAN		
	05073290001	164407		1
			6000 Joker 1x 10x159; 1x 13x177; 1x 17x224; 1x 19x246	



6000 Joker 4 Imperial Set 1 Set of ratcheting combination wrenches, Imperial

- In robust pouch

6000 Joker 4 Imperial Set 1 Set of ratcheting combination wrenches, Imperial



Code	EAN			
05073295001	4013288 167460			1
		6000 Joker Imperial 1x 7/16"x165; 1x 1/2"x177; 1x 9/16"x188; 1x 3/4"x246		

6001 Joker Switch

Joker ratcheting combination wrenches with angled ratchet head and switch lever. The metal plate in the jaw provides for the holding function which reduces the risk of losing nuts and bolts.

The integrated limit stop can prevent any slipping from the bolt head downwards and enables higher torque to be applied.

The exchangeable metal plate in the jaw securely holds nuts and bolts with its extra hard teeth and reduces the risk of slipping.

The double-hex geometry delivers a very positive connection with nuts or bolts and again provides for a lower risk of any slipping. The low return angle of only 30° at the jaw end avoids any time-consuming flipping of the wrench when fastening.

The reversible ratchet mechanism at the ring end with its fine toothing (80 teeth) ensures great flexibility even in confined spaces. Audibly precise ratchet mechanism.

Additionally, the robust two-piece locking element provides for an extreme stability. Comes with a 15° angled ratchet end for secure work even at high torque. The special forged geometry allows for high torque transfer and high flexural rigidity. Manufactured out of high-performance chrome-molybdenum steel with a nickel-chromium coating for high corrosion protection.

With Take it easy tool finder: colour coding according to size.

- Practical holding function thanks to the metal plate in the jaw
- Limit stop prevents any slipping
- Very fine toothing and robust locking element
- Ratchet end angled by 15°
- Take it easy tool finder with colour coding according to sizes

6001 Joker Switch Ratcheting combination wrenches, with switch lever



	EAN						
Code	4013288		mm	mm	mm	mm	mm
05020064001	184696		8	144	20,3	5,5	18 3
05020065001	183903		10	159	23	5,5	21,5 3
05020066001	183910		11	165	24,3	6,3	22 3
05020067001	183927		12	171	26,3	6,6	25 3
05020068001	184702		13	179	27,3	7	26 3
05020069001	184719		14	187	30	7,5	28 3
05020070001	184726		15	199	32	7,8	28,8 3
05020071001	184733		16	213	35	8,2	31,7 3
05020072001	184740		17	225	37	8,5	33 3
05020073001	184757		18	234	39,5	9	34 3
05020074001	184764		19	246	42	9,5	34,7 3

6001 Joker Switch Ratcheting combination wrenches, with switch lever, imperial



Code	EAN							
05020075001	184788		5/16"	144	20,3	5,5	18	3
05020076001	184795		3/8"	159	23	5,5	21,5	3
05020077001	184801		7/16"	165	24,3	6,3	22	3
05020078001	184818		1/2"	171	26,3	6,6	25	3
05020079001	184825		9/16"	187	30	7,5	28	3
05020080001	184832		5/8"	213	35	8,2	31,7	3
05020081001	184849		11/16"	234	39,5	9	34	3
05020082001	184771		3/4"	246	42	9,5	34,7	3

6002 Joker Double open-ended wrenches

- Practical holding function thanks to the metal plate in the jaw
- Limit stop prevents any slipping
- The double-hex geometry reduces the risk of slipping
- Return angle of only 30°
- Take it easy tool finder with colour coding according to sizes

6002 Joker Double open-ended wrenches



Code	EAN							
05020259001	219015		8	20	10	23	5,5	3
05003760001	173010		10	23	13	27	5,5	3
05003765001	173027		17	37	19	42	8,5	3
05020260001	212764		20	48	22	51	10	3
05020261001	212771		22	48	24	51	10	3
05020262001	212788		24	51	27	60	11	3
05020263001	212795		27	63	32	66	12	3
05020264001	212801		30	63	32	66	12	3

6001 Joker Switch 11 Set 1 Set of ratcheting combination wrenches

- Compact textile box with high robustness, low weight and volume

6001 Joker Switch 11 Set 1 Set of ratcheting combination wrenches



Code	EAN		
05020091001	184160		1
6001 Joker Switch 1x 8x144; 1x 10x159; 1x 11x165; 1x 12x171; 1x 13x179; 1x 14x187; 1x 15x199; 1x 16x213; 1x 17x225; 1x 18x234; 1x 19x246			

6001 Joker Switch 8 Imperial Set 1 Set of ratcheting combination wrenches, Imperial

- Compact textile box with high robustness, low weight and volume

6001 Joker Switch 8 Imperial Set 1 Set of ratcheting combination wrenches, Imperial



Code	EAN			
05020093001	184153			1
		6001 Joker Switch Imperial 1x 5/16"x144; 1x 3/8"x159; 1x 7/16"x165; 1x 1/2"x171; 1x 9/16"x187; 1x 5/8"x213; 1x 11/16"x234; 1x 3/4"x246		

6001 Joker Switch 4 Set 1 Set of ratcheting combination wrenches

- In robust pouch

6001 Joker Switch 4 Set 1 Set of ratcheting combination wrenches



Code	EAN			
05020090001	184139			1
		6001 Joker Switch 1x 10x159; 1x 13x179; 1x 17x225; 1x 19x246		

6001 Joker Switch 4 Imperial Set 1 Set of ratcheting combination wrenches, Imperial

- In robust pouch

6001 Joker Switch 4 Imperial Set 1 Set of ratcheting combination wrenches, Imperial



Code	EAN			
05020092001	184146			1
		6001 Joker Switch Imperial 1x 7/16"x165; 1x 1/2"x171; 1x 9/16"x187; 1x 3/4"x246		

6003 Joker ring spanner

As the installation space becomes increasingly tight during screwdriving, it remains necessary that tools enable users to work successfully.

Narrow spaces require additional placement points of the tool. Can spanners be modified so that the placement possibilities of the tool increase?

The combination of the 7.5° pivoted mouth and the double hexagon geometry doubles the placement points. A repeated 180° turn of the wrench around the longitudinal axis during screwdriving provides four placement possibilities, and bolts or screw heads can be "taken" every 15°.

The Joker 6003 with its smart mouth geometry significantly expands the range of uses in confined spaces. The Joker 6003 will automatically find the respective placement point after every turn.

The slim yet robust ring side is angled by 15° to the tool axis. The high-quality surface treatment achieves a high and long-lasting corrosion protection. With Take it easy tool finder: colour coding by size.

- Especially suitable for tight spaces
- The special mouth geometry expands the placement possibilities of the tool
- The low return angle in the mouth "takes" the screw every 15°
- Slim ring side angled by 15°
- Take it easy tool finder with colour coding according to sizes

6003 Joker ring spanner



Code	EAN							
Code	4013288		mm	mm	mm	mm	mm	
05020190001	219039		5,5	105	16	4	10	3
05020198001	218780		6	105	16	4	10	3
05020199001	218773		7	110	17,7	4,2	11,5	3
05020200001	212528		8	115	19	4,5	12,5	3
05020219001	220097		9	120	21	4,8	13,5	3
05020201001	212542		10	125	22	5	15	3
05020202001	212559		11	135	24,5	5	17	3
05020203001	212566		12	148	26	5,5	18	3
05020204001	212696		13	160	27	6	19	3
05020205001	212702		14	167	29	6	20	3
05020206001	212719		15	174	32	6	22	3
05020207001	212726		16	182	35	6,5	23	3
05020208001	212733		17	190	38	6,5	24,5	3
05020209001	212740		18	210	39	7,5	26	3
05020210001	212757		19	230	42	7,5	27,5	3
05020500001	218797		20	230	45	7,5	29	3
05020501001	218803		21	260	47	7,5	30	3
05020502001	218841		22	260	49	7,5	31,5	3
05020503001	218858		24	280	53	8	36	3
05020504001	218865		27	300	60	8,5	40	3
05020505001	218872		30	330	66	9	43	3
05020506001	218889		32	360	70	9,5	45,5	3
05020507001	218896		36	460	80	10	50,5	3

6003 Joker ring spanner, imperial



Code	EAN							
Code	4013288			mm	mm	mm	mm	
05020220001	219046		1/4"	105	16	4	10	3
05020211001	212979		5/16"	115	19	4,5	12,5	3
05020212001	212986		3/8"	125	22	5	15	3
05020213001	212993		7/16"	135	24,5	5	17	3
05020214001	213006		1/2"	160	26	6	19	3
05020215001	213013		9/16"	167	29	6	20	3
05020216001	213020		5/8"	182	35	6,5	23	3
05020217001	213037		11/16"	210	40	7,5	26	3
05020218001	213044		3/4"	230	42	7,5	27,5	3

6003 Joker Pedal ring spanner

The extra thin pedal wrench 6003 Joker Pedal is ideal for narrow installation spaces.

- Especially suitable for tight spaces
- The special mouth geometry expands the placement possibilities of the tool
- The low return angle in the mouth "takes" the screw every 15°
- Slim ring side angled by 15°
- Joker 6003 pedal size 15 with flat mouth to mount and dismount pedals
- With Take it easy tool finder: colour coding by size

6003 Joker Pedal ring spanner



Code	EAN							
Code	4013288		mm	mm	mm	mm	mm	
05020221001	220677		15	174	32	4,5	22	1



6003 Joker 22 Set 1 ring spanner set

As the installation space becomes increasingly tight during screwdriving, tools are necessary that enable users to work successfully even in such situations. Narrow spaces require additional placement points of the tool.

Can spanners be modified so that the placement possibilities of the tool increase? The combination of the 7.5° pivoted mouth and the double hexagon geometry doubles the placement points.

A repeated 180° turn of the wrench around the longitudinal axis during screwdriving provides four placement possibilities, and bolts or screw heads can be engaged every 15°. The Joker 6003 with its smart mouth geometry significantly expands the range of uses in confined spaces.

The Joker 6003 will automatically find the respective placement point after every turn. The slim yet robust ring side is angled by 15° to the tool axis. The high-quality surface treatment achieves a high and long-lasting corrosion protection. With tool finder Take it easy: colour coding by size.

- 22-piece ring spanner set - particularly suitable for narrow installation spaces
- The special mouth geometry expands the placement possibilities of the tool
- The low return angle in the mouth "takes" the screw every 15°
- Slim ring side angled by 15°

6003 Joker 22 Set 1 ring spanner set



Code	EAN		
05020232001	4013288 221087		1
6003 Joker 1x 5,5x105; 1x 6x105; 1x 7x110; 1x 8x115; 1x 9x120; 1x 10x125; 1x 11x135; 1x 12x148; 1x 13x160; 1x 14x167; 1x 15x174; 1x 16x182; 1x 17x190; 1x 18x210; 1x 19x230; 1x 20x230; 1x 21x260; 1x 22x260; 1x 24x280; 1x 27x300; 1x 30x330; 1x 32x360			

6003 Joker 15 Set 1 combination wrench set

- In robust pouch

6003 Joker 15 Set 1 combination wrench set



	Code	EAN		
	05020302001	4013288 222657		1
6003 Joker 1x 5,5x105; 1x 6x105; 1x 7x110; 1x 8x115; 1x 9x120; 1x 10x125; 1x 11x135; 1x 12x148; 1x 13x160; 1x 14x167; 1x 15x174; 1x 16x182; 1x 17x190; 1x 18x210; 1x 19x230 K240 1x 50,0x240,0				

6003 Joker 11 Set 1 ring spanner set

- In robust pouch

6003 Joker 11 Set 1 ring spanner set



	Code	EAN		
	05020231001	4013288 214195		1
6003 Joker 1x 8x115; 1x 10x125; 1x 11x135; 1x 12x148; 1x 13x160; 1x 14x167; 1x 15x174; 1x 16x182; 1x 17x190; 1x 18x210; 1x 19x230				

6003 Joker 8 Imperial Set 1 ring spanner set, Imperial

- In robust pouch

6003 Joker 8 Imperial Set 1 ring spanner set, Imperial



Code	EAN		
05020241001	4013288 214201		1
		6003 Joker Imperial 1x 5/16"x115; 1x 3/8"x125; 1x 7/16"x135; 1x 1/2"x160; 1x 9/16"x167; 1x 5/8"x182; 1x 11/16"x210; 1x 3/4"x230	

6003 Joker 5 Set 1 ring spanner set

- In robust pouch

6003 Joker 5 Set 1 ring spanner set



Code	EAN		
05020230001	4013288 214171		1
		6003 Joker 1x 8x115; 1x 10x125; 1x 13x160; 1x 17x190; 1x 19x230	

Bicycle set 10

5-piece Joker 6003 spanner set; size 15 in an extra-slim design. As the working space is very narrow when working on your bike, tools are necessary that enable users to work successfully even in such situations. Narrow spaces require additional placement points of the tool.

Can spanners be modified so that the placement possibilities of the tool increase? The combination of the 7.5° pivoted mouth and the double hexagon geometry doubles the placement points. A repeated 180° turn of the wrench around the longitudinal axis during screwdriving provides four placement possibilities, and bolts or screw heads can be engaged every 15°.

The Joker 6003 with its smart mouth geometry significantly expands the range of uses in confined spaces. The Joker 6003 will automatically find the respective placement point after every turn.

The slim yet robust ring side is angled by 15° to the tool axis. The high-quality surface treatment achieves a high and long-lasting corrosion protection. With tool finder Take it easy: colour coding by size.

The Joker bags are suitable for attachment to walls, shelves, workshop trolleys and the Wera 2go system thanks to the hook and loop fastener system on the back.

- Particularly suitable for narrow screwdriving situations on the bike
- The special mouth geometry expands the placement possibilities of the tool
- The low return angle in the mouth "takes" the screw every 15°
- Slim ring side angled by 15°
- Joker 6003 pedal size 15 with flat mouth to mount and dismount pedals



Bicycle set 10



Code	EAN		
05004178001	4013288 220653		1
		6003 Joker 1x 8x115; 1x 9x120; 1x 10x125; 1x 13x160	
		6003 Joker Pedal 1x 15x174	
		K120 1x 50,0x70,0	

Bicycle set 12

12-piece Joker 6003 spanner set; size 15 in an extra-slim design. As the working space is very narrow when working on your bike, tools are necessary that enable users to work successfully even in such situations.

Narrow spaces require additional placement points of the tool. Can spanners be modified so that the placement possibilities of the tool increase?

The combination of the 7.5° pivoted mouth and the double hexagon geometry doubles the placement points. A repeated 180° turn of the wrench around the longitudinal axis during screw-driving provides four placement possibilities, and bolts or screw heads can be engaged every 15°.

The Joker 6003 with its smart mouth geometry significantly expands the range of uses in confined spaces. The Joker 6003 will automatically find the respective placement point after every turn. The slim yet robust ring side is angled by 15° to the tool axis. The high-quality surface treatment achieves a high and long-lasting corrosion protection. With tool finder Take it easy: colour coding by size.

The Joker bags are suitable for attachment to walls, shelves, workshop trolleys and the Wera 2go system thanks to the hook and loop fastener system on the back.

- Especially suitable for tight spaces
- The special mouth geometry expands the placement possibilities of the tool
- The low return angle in the mouth “takes” the screw every 15°
- Slim ring side angled by 15°
- Joker 6003 pedal size 15 with flat mouth to mount and dismount pedals
- With Take it easy tool finder: colour coding by size
- In robust pouch

Bicycle set 12



Code	EAN		
05004181001	220721		1
		6003 Joker 1x 6x105; 1x 7x110; 1x 8x115; 1x 9x120; 1x 10x125; 1x 11x135; 1x 12x148; 1x 13x160; 1x 14x167; 1x 16x182; 1x 17x190	
		6003 Joker Pedal 1x 15x174	

6003 Joker 5 Imperial Set 1 ring spanner set, Imperial

- In robust pouch

6003 Joker 5 Imperial Set 1 ring spanner set, Imperial



Code	EAN		
05020240001	214188		1
		6003 Joker Imperial 1x 5/16"x115; 1x 3/8"x125; 1x 1/2"x160; 1x 9/16"x167; 1x 3/4"x230	

6003 Joker 4 Set 1 Ring spanner set

As the installation space becomes increasingly tight during screwdriving, it is necessary that tools enable users to work successfully even in such situations. Narrow spaces require additional placement points of the tool.

Can spanners be modified to increase the placement possibilities of the tool? The combination of the 7.5° pivoted mouth and the double hexagon geometry doubles the placement points.

A repeated 180° turn of the wrench around the longitudinal axis during screwdriving provides four placement possibilities, and bolts or screw heads can be engaged every 15°.

The Joker 6003 with its smart mouth geometry significantly expands the range of uses in confined spaces.

The Joker 6003 will automatically find the respective placement point after every turn. The slim yet robust ring side is angled by 15° to the tool axis.

The high-quality surface treatment achieves a high and long-lasting corrosion protection.

With Take it easy tool finder: Colour coding by size. The wear-free material of the clip guarantees easy removal and a secure hold of the spanners.

- Joker open-ended and combination wrenches and in a new clip for space-saving storage in the tool bag

6003 Joker 4 Set 1 Ring spanner set



Code	EAN		
05020228001	4013288 225665		1
		6003 Joker 1x 8x115; 1x 10x125; 1x 12x148; 1x 13x160	

6003 Joker 4 Set Imperial 1 Ring spanner set

- Joker open-ended and combination wrenches and in a new clip for space-saving storage in the tool bag

6003 Joker 4 Set Imperial 1 Ring spanner set



Code	EAN		
05020229001	4013288 225672		1
		6003 Joker Imperial 1x 5/16"x115; 1x 3/8"x125; 1x 7/16"x135; 1x 1/2"x160	



6004 Joker self-setting spanner

Many users wish to have a universal screwdriving tool with the widest possible range of applications. It should be a single tool for multiple metric and imperial dimensions.

It should automatically adjust to the different screw sizes. It should be safe to grab without damaging anything and allow for a high working speed. The continuous and parallel jaws replace several single spanner dimensions.

The required size is automatically and continuously set when attaching the tool to the hexagon bolt or screw. The integrated lever mechanism securely clamps the hexagon screw or bolt between the jaws, which significantly reduces the risk of slipping or damage.

The ratchet function ensures fast and consistent screwdriving without removing the tool. Thanks to the corner-width rectangular prisms, a back-pivoting angle of only 30° can be realized.

The single-arm design in conjunction with the ratchet function and the corner-width prism make it possible to work even in confined spaces.

The adjustable Joker 6004 is the universal screwdriving tool. Self-setting. Gripping. Spanning.

- The adjustable Joker 6004 covers all metric and imperial dimensions in the respective field of application
- Automatic and continuous grip of hexagon screws and bolts
- Lever mechanism when gripping avoids slipping and damage
- Fast and consistent screwdriving without removing the wrench thanks to mechanical ratchet function
- Back-pivoting angle of only 30° through placement in the corner-width rectangular prisms in the mouth

6004 Joker XS self-setting spanner



	EAN					
Code	4013288	mm		mm	mm	
05020099001	216892	7-10	1/4"-3/8"	117	7,7	3

6004 Joker S self-setting spanner



	EAN					
Code	4013288	mm		mm	mm	
05020100001	211729	10-13	7/16"-1/2"	154	10	3

6004 Joker M self-setting spanner



	EAN					
Code	4013288	mm		mm	mm	
05020103001	216908	13-16	1/2"-5/8"	188	12,4	3

6004 Joker L self-setting spanner



	EAN					
Code	4013288	mm		mm	mm	
05020101001	214706	16-19	5/8"-3/4"	224	14	3

6004 Joker XL self-setting spanner



	EAN					
Code	4013288	mm		mm	mm	
05020104001	216915	19-24	3/4"-19/16"	256	16	2

6004 Joker XXL self-setting spanner



Code	EAN	mm	mm	mm			
05020102001	214713	24-32	15/16"-1 1/4"	322	20		3

6004 Joker 4 set 1 self-setting spanner set

- The compact folding pouch with four adjustable Joker 6004 spanners covers all metric and imperial dimensions in applications from 7 to 19 mm or 1/4" to 3/4"

6004 Joker 4 set 1 self-setting spanner set



Code	EAN						
05020110001	217516						1
			6004 Joker XS				
			1x 7-10 (1/4"-3/8")x117				
			6004 Joker S				
			1x 10-13 (7/16"-1/2")x154				
			6004 Joker M				
			1x 13-16 (1/2"-5/8")x188				
			6004 Joker L				
			1x 16-19 (5/8"-3/4")x224				

6005 Joker Double open-ended wrenches

- Double open-ended wrench
- Especially suitable for tight spaces
- The special mouth geometry expands the placement possibilities of the tool
- The low return angle in the mouth "takes" the screw every 15°
- With Take it easy tool finder: colour coding by size

6005 Joker Double open-ended wrenches



Code	EAN		mm	mm	mm	mm	mm	
05020310001	224873		6	16	7	17,7	4	3
05020311001	224880		8	19	9	21	4,5	3
05020312001	224897		10	23	11	25	5	3
05020313001	224903		12	26	13	27	5,5	3

6005 Joker 4 Set 1 Double open-ended wrench set

- Joker open-ended and combination wrenches and in a new clip for space-saving storage in the tool bag

6005 Joker 4 Set 1 Double open-ended wrench set



Code	EAN				
05020314001	224750				1
			6005 Joker Double		
			1x 6x7x111,8; 1x 8x9x122,2; 1x 10x11x137,3;		
			1x 12x13x166		







L-Keys

Hex-Plus - lets hexagon socket screws last longer

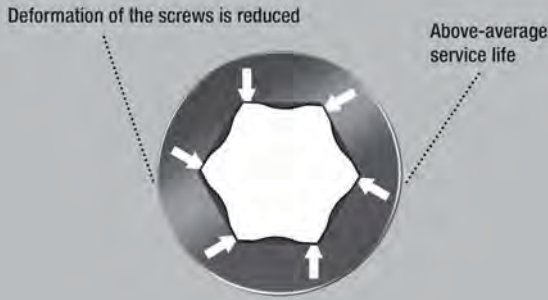

Kraftform Stainless - stainless steel to prevent rust



High quality L-key set out of stainless steel for hexagon socket screws by Wera. Stainless steel prevents the transfer of extraneous rust. The Hex-Plus profile offers a greater contact surface in the head of the screw.

The notching effect is therefore reduced to a minimum and damage to the screw head more or less eliminated. Come with hex ballpoint on the long arm: the ballpoint drive profile means that it is possible to swivel the tool axis away from the screwdriving axis, thus enabling "round the corner" screwdriving.

Take it easy Tool Finder: colour coding according to size. In an almost wear-free L-key clip fastener.

- Solution to the extraneous rust problem: fasten stainless screws with stainless tools
- Hex-Plus allows socket head screws to live longer
- Take it easy tool finder with colour coding according to sizes
- Wear-resistant clip material for enhanced durability
- Colour coded, easy-to-grip plastic sleeve, even at low temperatures

3950/9 Hex-Plus Multicolour HF Stainless 1 L-key set, metric, stainless steel, with holding function

- From size 3.0, the holding function on the long arm will hold screws securely on the tool

3950/9 Hex-Plus Multicolour HF Stainless 1 L-key set, metric, stainless steel, with holding function



Code	EAN		
05022699001	4013288 224477		1
		<ul style="list-style-type: none"> ○ 3950 SPKL Multicolour 1x 1,5x90; 1x 2,0x101; 1x 2,5x112 ○ 3950 SPKL Multicolour HF 1x 3,0x123; 1x 4,0x137; 1x 5,0x154; 1x 6,0x172; 1x 8,0x195; 1x 10,0x224 	

3950/9 Hex-Plus Multicolour Stainless 1 L-key set, metric, stainless



Code	EAN		
05022669001	4013288 185211		1
		<ul style="list-style-type: none"> ○ 3950 SPKL Multicolour 1x 1,5x90; 1x 2,0x101; 1x 2,5x112; 1x 3,0x123; 1x 4,0x137; 1x 5,0x154; 1x 6,0x172; 1x 8,0x195; 1x 10,0x224 	

3950/9 Hex-Plus Stainless 1 L-key set, metric, stainless



Code	EAN		
05022720001	4013288 111364		10
		○ 3950 PKL 1x 1,5x90; 1x 2,0x101; 1x 2,5x112; 1x 3,0x123; 1x 4,0x137; 1x 5,0x154; 1x 6,0x172; 1x 8,0x195; 1x 10,0x224	

3950/9 Hex-Plus Stainless 1 SB L-key set, metric, stainless



Code	EAN		
05073544001	4013288 180377		1
		○ 3950 PKL 1x 1,5x90; 1x 2,0x101; 1x 2,5x112; 1x 3,0x123; 1x 4,0x137; 1x 5,0x154; 1x 6,0x172; 1x 8,0x195; 1x 10,0x224	

3950/9 Hex-Plus Imperial Stainless 1 L-key set, Imperial, stainless

- In robust pouch

3950/9 Hex-Plus Imperial Stainless 1 L-key set, imperial, stainless

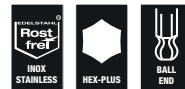

Code	EAN		
05022721001	4013288 117281		1
		○ 3950 PKL inch 1x 3/32"x112; 1x 7/64"x119; 1x 1/8"x123; 1x 9/64"x130; 1x 5/32"x137; 1x 3/16"x154; 1x 1/4"x185; 1x 5/16"x195; 1x 3/8"x224	

950/9 Hex-Plus Multicolour HF 1 L-key set, metric, BlackLaser, with holding function

- L-keys with retaining function for hexagon socket screws
- Hexagonal ballpoint on the long arm
- Colour coded, easy-to-grip plastic sleeve, even at low temperatures

950/9 Hex-Plus Multicolour HF 1 L-key set, metric, BlackLaser, with holding function



Code	EAN		
05022210001	4013288 188403		1
		○ 950 SPKL Multicolour 1x 1,5x90; 1x 2,0x101; 1x 2,5x112	
		○ 950 SPKL HF Multicolour 1x 3,0x123; 1x 4,0x137; 1x 5,0x154; 1x 6,0x172; 1x 8,0x195; 1x 10,0x224	



950/9 Hex-Plus Multicolour 1 L-key set, metric, BlackLaser

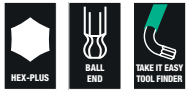

Code	EAN		
05022089001	4013288 180841		5
		950 SPKL Multicolour 1x 1,5x90; 1x 2,0x101; 1x 2,5x112; 1x 3,0x123; 1x 4,0x137; 1x 5,0x154; 1x 6,0x172; 1x 8,0x195; 1x 10,0x224	

950/9 Hex-Plus Multicolour 1 SB L-key set, metric, BlackLaser

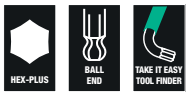

Code	EAN		
05073593001	4013288 165688		1
		950 SPKL Multicolour 1x 1.5x90; 1x 2.0x101; 1x 2.5x112; 1x 3.0x123; 1x 4.0x137; 1x 5.0x154; 1x 6.0x172; 1x 8.0x195; 1x 10.0x224	

L-keys in a two-component clip

L-keys fit securely into the clip

Solid rubber material for great durability

Easy-to-use opening and closing mechanism

Sizes marked on the clip



950/9 Hex-Plus Multicolour 2 L-key set, metric, BlackLaser



Code	EAN		
05133164001	4013288 207517		1
		950 SPKS Multicolour 1x 1,5x50; 1x 2,0x56; 1x 2,5x63; 1x 3,0x71; 1x 4,0x80; 1x 5,0x90; 1x 6,0x100; 1x 8,0x112; 1x 10,0x125	

3950/9 Hex-Plus Multicolour Imperial Stainless 1, imperial, stainless steel

Premium L-key set made of stainless steel for imperial hexagonal socket screws by Wera. Stainless steel prevents transmission of extraneous rust.

The Hex-Plus profile offers larger contact surfaces in the screw head. The notch effect is reduced to a minimum and the destruction of the screw head is almost eliminated.

With hexagonal ball tip at the long arm: The ball-shaped tip profiles enable the tool shaft to be moved and pivoted relative to the screw axis which allows screwdriving "around the corner".

Take it easy tool finder with colour coding by size. In an almost wear-free L-key clip.

3950/9 Hex-Plus Multicolour Imperial Stainless 1, imperial, stainless steel



Code	EAN		
05022860001	4013288 221360		1
		3950 SPKL Multicolour Imperial 1x 5/64"x101; 1x 3/32"x112; 1x 1/8"x123; 1x 5/32"x137; 1x 3/16"x154; 1x 7/32"x172; 1x 1/4"x185; 1x 9/16"x195; 1x 3/8"x224	

950/9 Hex-Plus Multicolour Imperial 1 L-key set, imperial, BlackLaser

- In robust pouch

950/9 Hex-Plus Multicolour Imperial 1 L-key set, imperial, BlackLaser

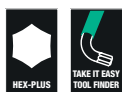

	Code	EAN		
	05022639001	4013288 182593		1
			○ 950 SPKL inch 1x 5/64"x101; 1x 3/32"x112; 1x 1/8"x123; 1x 5/32"x137; 1x 3/16"x154; 1x 7/32"x172; 1x 1/4"x185; 1x 5/16"x195; 1x 3/8"x224	

950/9 Hex-Plus Multicolour imperial 2 L-key set, imperial, BlackLaser

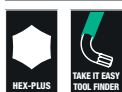

	Code	EAN		
	05022640001	4013288 219107		1
			○ 950 SPKL inch 1x 5/64"x101; 1x 3/32"x112; 1x 1/8"x123; 1x 5/32"x137; 1x 3/16"x154; 1x 7/32"x172; 1x 1/4"x185; 1x 5/16"x195; 1x 3/8"x224	

950/7 Hex-Plus Multicolour Magnet 1 L-key set, metric, BlackLaser

- For recessed screws, it's often advantageous for the screw to be held on the L-key by magnetic force. The Wera clips with magnetiser/demagnetiser enable a magnetisation/demagnetisation of L-keys in a flash.

950/7 Hex-Plus Multicolour Magnet 1 L-key set, metric, BlackLaser



	Code	EAN		
	05022534001	4013288 183750		5
			○ 950 SPKL Multicolour 1x 1,5x90; 1x 2,0x101; 1x 2,5x112; 1x 3,0x123; 1x 4,0x137; 1x 5,0x154; 1x 6,0x172	

950/9 L Hex-Plus HF 1 L-key set, metric, chrome-plated, with holding function

- The holding function on the long arm keeps screws securely on the tool
- High corrosion protection thanks to chrome-plating

950/9 L Hex-Plus HF 1 L-key set, metric, chrome-plated, with holding function



	Code	EAN		
	05022130001	4013288 207227		1
			○ 950 L 1x 1,5x90 ¹⁾ ; 1x 2,0x100; 1x 2,5x112 ○ 950 L HF 1x 3,0x126; 1x 4,0x140; 1x 5,0x160; 1x 6,0x180; 1x 8,0x200; 1x 10,0x219	

¹⁾Regular hexagon

950/9 Hex-Plus 1 L-key set, metric, chrome-plated



	Code	EAN		
	05022087001	4013288 104816		10
			○ 950 PKL 1x 1,5x90 ¹⁾ ; 1x 2,0x100; 1x 2,5x112; 1x 3,0x126; 1x 4,0x140; 1x 5,0x160; 1x 6,0x180; 1x 8,0x200; 1x 10,0x219	

¹⁾Regular hexagon

950/9 Hex-Plus 1 SB L-key set, metric, chrome-plated



	Code	EAN		
	05073391001	4013288 030160		1
			○ 950 PKL 1x 1,5x90 ¹⁾ ; 1x 2,0x100; 1x 2,5x112; 1x 3,0x126; 1x 4,0x140; 1x 5,0x160; 1x 6,0x180; 1x 8,0x200; 1x 10,0x219	

¹⁾Regular hexagon



950/9 Hex-Plus 2 L-key set, metric, chrome-plated



Code	EAN		
	4013288		
05021909001	111937		10
		950 L 1x 1,5x90 ¹⁾ ; 1x 2,0x100; 1x 2,5x112; 1x 3,0x126; 1x 4,0x140; 1x 5,0x160; 1x 6,0x180; 1x 8,0x200; 1x 10,0x219	

¹⁾Regular hexagon

950/9 Hex-Plus 3 L-key set, metric, chrome-plated

- Short version
- Hexagonal ballpoint on the long arm

950/9 Hex-Plus 3 L-key set, metric, chrome-plated



Code	EAN		
	4013288		
05133163001	112255		10
		950 PKS 1x 1,5x50 ¹⁾ ; 1x 2,0x56; 1x 2,5x63; 1x 3,0x71; 1x 4,0x80; 1x 5,0x90; 1x 6,0x100; 1x 8,0x112; 1x 10,0x125	

¹⁾Regular hexagon

950/9 Hex-Plus 4 L-key set, metric, chrome-plated

- Extra-short arm for use on difficult-to-access screws
- Hexagonal ballpoint on the long arm

950/9 Hex-Plus 4 L-key set, metric, chrome-plated



Code	EAN		
	4013288		
05073594001	139177		1
		950 PKLS 1x 1,5x90 ¹⁾ ; 1x 2,0x100; 1x 2,5x112; 1x 3,0x126; 1x 4,0x140; 1x 5,0x160; 1x 6,0x180; 1x 8,0x200; 1x 10,0x219	

¹⁾Regular hexagon

950/9 Hex-Plus 5 L-key set, metric, chrome-plated



Code	EAN		
	4013288		
05021406001	111890		10
		950 1x 1,5x45 ¹⁾ ; 1x 2,0x50; 1x 2,5x56; 1x 3,0x63; 1x 4,0x70; 1x 5,0x80; 1x 6,0x90; 1x 8,0x100; 1x 10,0x112	

¹⁾Regular hexagon.

950/9 Hex-Plus 6 L-key set, metric, BlackLaser

- BlackLaser for high corrosion protection and long service life

950/9 Hex-Plus 6 L-key set, metric, BlackLaser



Code	EAN		
	4013288		
05022086001	104809		10
		950 PKL BM 1x 1,5x90 ¹⁾ ; 1x 2,0x100; 1x 2,5x112; 1x 3,0x126; 1x 4,0x140; 1x 5,0x160; 1x 6,0x180; 1x 8,0x200; 1x 10,0x219	

¹⁾Regular hexagon

950/9 Hex-Plus 6 SB L-key set, metric, BlackLaser



Code	EAN		
	4013288		
05073596001	106414		1
		950 PKL BM 1x 1.5x90 ¹⁾ ; 1x 2.0x100; 1x 2.5x112; 1x 3.0x126; 1x 4.0x140; 1x 5.0x160; 1x 6.0x180; 1x 8.0x200; 1x 10.0x219	

¹⁾Regular hexagon

950/9 Hex-Plus 7 L-key set, metric, BlackLaser

- Short version

950/9 Hex-Plus 7 L-key set, metric, BlackLaser



Code	EAN		
05021737001	112286		10
		950 BM 1x 1,5x45 ¹⁾ ; 1x 2,0x50; 1x 2,5x56; 1x 3,0x63; 1x 4,0x70; 1x 5,0x80; 1x 6,0x90; 1x 8,0x100; 1x 10,0x112	

¹⁾Regular hexagon

950/7 Hex-Plus Magnet 1 Magnetic L-key set, metric, chrome-plated

- For recessed screws, it's often advantageous for the screw to be held on the L-key by magnetic force. The Wera clips with magnetiser/demagnetiser enable a magnetisation/demagnetisation of L-keys in a flash.

950/7 Hex-Plus Magnet 1 Magnetic L-key set, metric, chrome-plated



Code	EAN		
05022101001	111968		10
		950 PKL 1x 1,5x90 ¹⁾ ; 1x 2,0x100; 1x 2,5x112; 1x 3,0x126; 1x 4,0x140; 1x 5,0x160; 1x 6,0x180	

¹⁾Regular hexagon

950/7 Hex-Plus 1 L-key set, metric, chrome-plated

- Hexagonal ballpoint on the long arm

950/7 Hex-Plus 1 L-key set, metric, chrome-plated



Code	EAN		
05022181001	111883		10
		950 PKL 1x 1,5x90 ¹⁾ ; 1x 2,0x100; 1x 2,5x112; 1x 3,0x126; 1x 4,0x140; 1x 5,0x160; 1x 6,0x180	

¹⁾Regular hexagon

950/13 Hex-Plus Imperial 1 L-key set, imperial, BlackLaser

- BlackLaser for high corrosion protection and long service life
- Hexagonal ballpoint on the long arm

950/13 Hex-Plus Imperial 1 L-key set, imperial, BlackLaser



Code	EAN		
05021728001	111982		10
		950 PKL inch 1x 0,05"x83 ¹⁾ ; 1x 1/16"x91 ¹⁾ ; 1x 5/64"x100; 1x 3/32"x112; 1x 7/64"x119; 1x 1/8"x126; 1x 9/64"x132; 1x 5/32"x140; 1x 3/16"x160; 1x 7/32"x180; 1x 1/4"x190; 1x 5/16"x200; 1x 3/8"x212	

¹⁾Regular hexagon



950/13 Hex-Plus Imperial 1 SB L-key set, imperial, BlackLaser

Premium L-key set made of stainless steel for imperial hexagonal socket screws in convenient clip made of wear-free material for a permanently secure hold of the L-keys while also being easily accessible. L-keys with Hex-Plus profile which offers larger contact surfaces in the screw head.

The notch effect is reduced to a minimum and the destruction of the screw head is almost eliminated. The ball at the long arm allows safe working even in difficult installation positions.

The BlackLaser surface treatment makes for excellent surface protection, even from corrosion, and for long durability.

Lasered and therefore abrasion-proof size marking on the L-keys for quick access.

950/13 Hex-Plus Imperial 1 SB L-key set, imperial, BlackLaser



Code	EAN		
05021721001	221315	950 PKL inch 1x 0.05"x83 ¹⁾ ; 1x 1/16"x91 ¹⁾ ; 1x 5/64"x100; 1x 3/32"x112; 1x 7/64"x119; 1x 1/8"x126; 1x 9/64"x132; 1x 7/32"x140; 1x 7/16"x160; 1x 7/32"x180; 1x 1/4"x190; 1x 5/16"x200; 1x 3/8"x212	1

¹⁾Regular hexagon

950/9 Hex-Plus Imperial 1 L-key set, imperial, BlackLaser



Code	EAN		
05022171001	111975	950 PKL inch 1x 5/64"x100; 1x 3/32"x112; 1x 1/8"x126; 1x 5/32"x140; 1x 3/16"x160; 1x 7/32"x180; 1x 1/4"x190; 1x 5/16"x200; 1x 3/8"x212	10

950/9 Hex-Plus Imperial 1 SB L-key set, imperial, BlackLaser



Code	EAN		
05133180001	154118	950 PKL inch 1x 5/64"x100; 1x 3/32"x112; 1x 1/8"x126; 1x 5/32"x140; 1x 3/16"x160; 1x 7/32"x180; 1x 1/4"x190; 1x 5/16"x200; 1x 3/8"x212	1

Bicycle Set 4

L-keys made from circular material with plastic sleeve for use on bicycles. The plastic sleeve makes working comfortable even at low temperatures and is easy on the fingers.

All L-keys are easily accessible due to their colour coding and size markings. For hexagonal socket screws and TORX® screws. In a robust and lightweight folding pouch.

- In a practical, lightweight folding pouch for easy carrying

Bicycle Set 4



Code	EAN		
05004173001	211446	950 SPKL Multicolour 1x 2,0x101; 1x 2,5x112	1
		950 SPKL HF Multicolour 1x 3,0x123; 1x 4,0x137; 1x 5,0x154; 1x 6,0x172; 1x 8,0x195	
		967 SXL TORX® HF Multicolour 1x TX 10x112; 1x TX 25x154	

3950 SPKL Multicolour HF L-key, metric, stainless steel, with holding function

High quality L-keys out of stainless steel for hexagonal socket screws by Wera. Stainless steel prevents the transfer of extraneous rust. The Hex-Plus profile offers a greater contact surface in the head of the screw.

The notching effect is therefore reduced to a minimum and damage to the screw head more or less eliminated. Come with hex ballpoint on the long arm: the ballpoint drive profile means that it is possible to swivel the tool axis away from the screwdriving axis, thus enabling "round the corner" screwdriving. Take it easy Tool Finder: colour coding according to size.

- Solution to the extraneous rust problem: fasten stainless screws with stainless tools
- Stainless L-keys prevent extraneous rust on stainless screws
- Hex-Plus allows socket head screws to live longer
- With holding function (HF) on the long arm to securely hold the screw on the tool
- The ball head on the long arm also allows offset use
- With Take it easy tool finder: colour coding by size
- All L-keys have a colour-coded, easy-grip hose sleeve for ergonomic and comfortable operation even at low temperatures
- With Take it easy tool finder: colour coding by size

3950 SPKL Multicolour HF L-key, metric, stainless steel, with holding function



	EAN		⊙	L ₁	L ₂	L ₃	L ₄	
Code	4013288		mm	mm	mm			
05022693001	224415		3,0	123	21	4 7/8"	27/32"	10
05022694001	224422		4,0	137	24	5 3/8"	1"	10
05022695001	224439		5,0	154	27	6 1/16"	1 1/16"	10
05022696001	224446		6,0	172	31	6 3/4"	1 1/4"	10
05022697001	224453		8,0	195	37	7 11/16"	1 7/16"	10
05022698001	224460		10,0	224	42	9"	1 11/16"	10

3950 SPKL Multicolour L-key, metric, stainless

High quality L-keys out of stainless steel for hexagonal socket screws by Wera. Stainless steel prevents the transfer of extraneous rust. The Hex-Plus profile offers a greater contact surface in the head of the screw.

The notching effect is therefore reduced to a minimum and damage to the screw head more or less eliminated.

Come with hex ballpoint on the long arm: the ballpoint drive profile means that it is possible to swivel the tool axis away from the screwdriving axis, thus enabling "round the corner" screwdriving.

Take it easy Tool Finder: colour coding according to size. In an almost wear-free L-key clip fastener.

- Solution to the extraneous rust problem: fasten stainless screws with stainless tools
- Hex-Plus allows socket head screws to live longer
- Stainless L-keys prevent extraneous rust on stainless screws
- Take it easy tool finder with colour coding according to sizes
- Wear-resistant clip material for enhanced durability



3950 SPKL Multicolour L-key, metric, stainless



	EAN		⊙	L ₁	L ₂	L ₃	L ₄	
Code	4013288		mm	mm	mm			
05022660001	185792		1,5	90	14	3 1/2"	9/16"	10
05022661001	185808		2,0	101	16	4"	5/8"	10
05022662001	185815		2,5	112	19	4 7/16"	3/4"	10
05022663001	185822		3,0	123	21	4 7/8"	27/32"	10
05022664001	185839		4,0	137	24	5 3/8"	1"	10
05022665001	185846		5,0	154	27	6 1/16"	1 1/16"	10
05022666001	185860		6,0	172	31	6 3/4"	1 1/4"	10
05022667001	185877		8,0	195	37	7 11/16"	1 7/16"	10
05022668001	185884		10,0	224	42	9"	1 11/16"	10



3950 SPKL Multicolour L-keys, imperial, stainless



Code	EAN	Hex	L ₁	L ₂	L ₃	L ₄	Box
Code	EAN	mm	mm	mm	mm	mm	
05022850001	221384	5/64"	101	16	4"	5/8"	10
05022851001	221469	3/32"	112	19	4 7/16"	3/32"	10
05022852001	221452	1/8"	123	21	4 7/8"	1/8"	10
05022853001	221445	5/32"	137	24	5 3/8"	5/32"	10
05022854001	221438	3/16"	154	27	6 1/16"	3/16"	10
05022855001	221377	7/32"	172	31	6 3/4"	7/32"	10
05022856001	221421	1/4"	185	34	7 1/4"	1/4"	10
05022857001	221414	5/16"	195	37	7 11/16"	5/16"	10
05022858001	221407	3/8"	224	42	9"	3/8"	10

3950 PKL L-key, metric, stainless

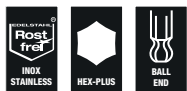

Code	EAN	Hex	L ₁	L ₂	L ₃	L ₄	Box
Code	EAN	mm	mm	mm	mm	mm	
05022700001	111265	1,5	90	14	3 1/2"	9/16"	10
05022701001	111272	2,0	101	16	4"	5/8"	10
05022702001	111289	2,5	112	19	4 7/16"	3/4"	10
05022703001	111296	3,0	123	21	4 7/8"	27/32"	10
05022704001	111302	4,0	137	24	5 3/8"	1"	10
05022705001	111319	5,0	154	27	6 1/16"	1 1/16"	10
05022706001	111326	6,0	172	31	6 3/4"	1 1/4"	10
05022708001	111340	8,0	195	37	7 11/16"	1 7/16"	10
05022709001	111357	10,0	224	42	9"	1 11/16"	10

3950 PKL L-key, imperial, stainless



Code	EAN	Hex	L ₁	L ₂	L ₃	L ₄	Box
Code	EAN	mm	mm	mm	mm	mm	
05022710001	117151	3/32"	112	19	4 7/16"	3/4"	10
05022711001	117168	7/64"	119	20	4 3/4"	25/32"	10
05022712001	117175	1/8"	123	21	4 7/8"	27/32"	10
05022713001	117182	9/64"	130	22	5 3/16"	29/32"	10
05022714001	117199	5/32"	137	24	5 3/8"	1"	10
05022715001	117205	3/16"	154	27	6 1/16"	1 1/16"	10
05022716001	117212	1/4"	185	34	7 1/4"	1 5/16"	10
05022717001	117229	5/16"	195	37	7 11/16"	1 7/16"	10
05022718001	117236	3/8"	224	42	9"	1 11/16"	5

950 SPKL HF L-key Multicolour, metric, with holding function

- The holding function holds screws securely on the tool

950 SPKL HF L-key Multicolour, metric, with holding function



Code	EAN	Hex	L ₁	L ₂	L ₃	L ₄	Box
Code	EAN	mm	mm	mm	mm	mm	
05022200001	188342	3,0	123	21	4 7/8"	27/32"	10
05022201001	188359	4,0	137	24	5 3/8"	1"	10
05022202001	188366	5,0	154	27	6 1/16"	1 1/16"	10
05022203001	188373	6,0	172	31	6 3/4"	1 1/4"	10
05022204001	188380	8,0	195	37	7 11/16"	1 7/16"	10
05022205001	188397	10,0	224	42	9"	1 11/16"	10

950 SPKL L-key Multicolour, metric

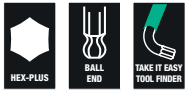

	EAN		⊙	L'	L	L'	L	📦
Code	4013288		mm	mm	mm			
05022600001	167842		1,5	90	14	3 1/2"	9/16"	10
05022602001	167934		2,0	101	16	4"	5/8"	10
05022604001	167859		2,5	112	19	4 7/16"	3/4"	10
05022606001	167866		3,0	123	21	4 7/8"	27/32"	10
05022608001	167873		4,0	137	24	5 3/8"	1"	10
05022610001	167880		5,0	154	27	6 1/16"	1 1/16"	10
05022612001	167897		6,0	172	31	6 3/4"	1 1/4"	10
05022614001	167903		8,0	195	37	7 11/16"	1 7/16"	10
05022616001	167910		10,0	224	42	9"	1 11/16"	10

950 SPKL L-key Multicolour, imperial



	EAN		⊙	L'	L	L'	L	📦
Code	4013288			mm	mm			
05022630001	182500		5/64"	101	16	4"	5/8"	10
05022631001	182517		3/32"	112	19	4 7/16"	3/4"	10
05022632001	182524		1/8"	123	21	4 7/8"	27/32"	10
05022633001	182531		5/32"	137	24	5 3/8"	1"	10
05022634001	182548		3/16"	154	27	6 1/16"	1 1/16"	10
05022635001	182555		7/32"	172	31	6 3/4"	1 1/4"	10
05022636001	182562		1/4"	185	34	7 1/4"	1 5/16"	10
05022637001	182579		5/16"	195	37	7 11/16"	1 7/16"	10
05022638001	182586		3/8"	224	42	9"	1 11/16"	10

950 SPKS L-key Multicolour, metric

- Short version

950 SPKS L-key Multicolour, metric

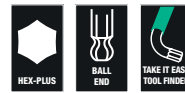

	EAN		⊙	L'	L	L'	L	📦
Code	4013288		mm	mm	mm			
05022678001	211910		1,5	50	14	2"	9/16"	10
05022670001	211934		2,0	56	16	2 7/32"	5/8"	10
05022671001	211927		2,5	63	19	2 1/2"	3/4"	10
05022672001	211941		3,0	71	21	2 3/4"	27/32"	10
05022673001	211958		4,0	80	24	3 1/8"	1"	10
05022674001	211965		5,0	90	27	3 1/2"	1 1/16"	10
05022675001	211972		6,0	100	31	4"	1 1/4"	10
05022676001	211989		8,0	112	37	4 7/16"	1 7/16"	10
05022677001	211996		10,0	125	42	5"	1 11/16"	10



950 PKL L-key, metric, chrome-plated

- High corrosion protection thanks to chrome-plating
- Hexagonal ballpoint on the long arm

950 PKL L-key, metric, chrome-plated



Code	EAN	⊙	L ₁	L ₂	L ₃	L ₄	
05022050001 ¹⁾	018779	1,5	90	14	3 1/2"	9/16"	10
05022052001	018786	2,0	100	16	4"	5/8"	10
05022054001	018793	2,5	112	18	4 7/16"	23/32"	10
05022056001	018809	3,0	126	20	5"	25/32"	10
05022058001	018816	4,0	140	25	5 1/2"	1"	10
05022060001	018823	5,0	160	28	6 5/16"	1 3/32"	10
05022062001	018830	6,0	180	32	7 1/16"	1 1/4"	10
05022063001	037718	7,0	190	34	7 1/2"	1 5/16"	10
05022064001	018847	8,0	200	36	8"	1 7/16"	10
05022066001	018854	10,0	219	40	8 11/16"	1 9/16"	10
05022067001	038708	12,0	248	45	10"	1 3/4"	5

¹⁾Regular hexagon

950 PKL BM L-key, metric, BlackLaser

- BlackLaser for high corrosion protection and long service life
- Hexagonal ballpoint on the long arm

950 PKL BM L-key, metric, BlackLaser

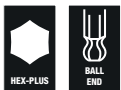

Code	EAN	⊙	L ₁	L ₂	L ₃	L ₄	
05027101001 ¹⁾	094988	1,5	90	14	3 1/2"	9/16"	10
05027102001	094995	2,0	100	16	4"	5/8"	10
05027103001	095008	2,5	112	18	4 7/16"	23/32"	10
05027104001	095015	3,0	126	19	5"	3/4"	10
05027105001	095022	4,0	140	25	5 1/2"	1"	10
05027106001	095039	5,0	160	28	6 5/16"	1 3/32"	10
05027107001	095046	6,0	180	32	7 1/16"	1 1/4"	10
05027110001	095053	7,0	190	34	7 1/2"	1 5/16"	10
05027108001	095060	8,0	200	36	8"	1 7/16"	10
05027109001	095077	10,0	219	40	8 11/16"	1 9/16"	10
05027111001	095084	12,0	248	45	10"	1 3/4"	5

¹⁾Regular hexagon

950 PKL L-key, imperial, BlackLaser



Code	EAN	⊙	L ₁	L ₂	L ₃	L ₄	
05022079001 ¹⁾	041203	0,05"	83	14	3 1/4"	9/16"	10
05022081001 ¹⁾	041210	1/16"	91	15	3 1/2"	19/32"	10
05022068001	018861	5/64"	100	16	4"	5/8"	10
05022070001	018878	3/32"	112	18	4 7/16"	23/32"	10
05022071001	041227	7/64"	119	19	4 3/4"	3/4"	10
05022072001	018885	1/8"	126	20	5"	25/32"	10
05022073001	041234	9/64"	132	23	5 3/16"	29/32"	10
05022074001	018892	5/32"	140	25	5 1/2"	1"	10
05022076001	018908	3/16"	160	25	6 5/16"	1"	10
05022078001	018915	7/32"	180	27	7 1/16"	1 1/16"	10
05022080001	018922	1/4"	190	34	7 1/2"	1 5/16"	10
05022082001	018939	5/16"	200	36	8"	1 7/16"	10
05022095001	038739	3/8"	212	38	8 3/8"	1 1/2"	5
05022096001	038746	1/2"	224	40	9"	1 9/16"	5

¹⁾Regular hexagon

950 PKLS Long Arm Ballpoint Hex Key, metric, chrome plated

- Extra-short arm for use on difficult-to-access screws

950 PKLS Long Arm Ballpoint Hex Key, metric, chrome plated



Code	EAN	⊙	L ₁	L ₂	L ₃	L ₄	
05022040001 ¹⁾	139429	1,5	90	4,5	3 1/2"	11/64"	10
05022041001	139283	2,0	100	5,5	4"	7/32"	10
05022042001	139290	2,5	112	6,5	4 7/16"	1/4"	10
05022043001	139306	3,0	126	7,5	5"	19/64"	10
05022044001	139313	4,0	140	10,0	5 1/2"	25/64"	10
05022045001	139320	5,0	160	12	6 5/16"	15/32"	10
05022046001	139337	6,0	180	15	7 1/16"	19/32"	10
05022047001	139344	8,0	200	19	8"	3/4"	10
05022048001	139351	10,0	219	22	8 5/8"	7/8"	10

¹⁾Regular hexagon

950 PKS L-key, metric, chrome-plated

- Short design for particularly confined screwdriving situations

950 PKS L-key, metric, chrome-plated



	EAN	⊘	L ₁	L ₂	L ₃	L ₄		
Code	4013288	mm	mm	mm				
05133150001 ¹⁾	098047	1,5	50	14	2"	9/16"		10
05133151001	098054	2,0	56	16	2 7/32"	5/8"		10
05133152001	098061	2,5	63	18	2 1/2"	23/32"		10
05133153001	098078	3,0	71	20	2 3/4"	25/32"		10
05133154001	098085	4,0	80	22	3"	29/32"		10
05133155001	098092	5,0	90	25	3 1/2"	1"		10
05133156001	098108	6,0	100	28	4"	1 3/32"		10
05133157001	098115	8,0	112	32	4 7/16"	1 1/4"		10
05133158001	098122	10,0	125	36	5"	1 5/16"		10

¹⁾Regular hexagon

950 L HF L-key, metric, chrome-plated, with holding function

- The holding function on the long arm keeps screws securely on the tool

950 L HF L-key, metric, chrome-plated, with holding function



	EAN	⊘	L ₁	L ₂	L ₃	L ₄		
Code	4013288	mm	mm	mm				
05022120001	207258	3,0	126	20	5"	25/32"		10
05022121001	207265	4,0	140	25	5 1/2"	1"		10
05022122001	207319	5,0	160	28	6 5/16"	1 3/32"		10
05022123001	207326	6,0	180	32	7 1/16"	1 1/4"		10
05022124001	207340	8,0	200	36	8"	1 7/16"		10
05022125001	207333	10,0	219	40	8 11/16"	1 9/16"		5

950 L-key, metric, chrome-plated



	EAN	⊘	L ₁	L ₂	L ₃	L ₄		
Code	4013288	mm	mm	mm				
05021600001 ¹⁾	038722	1,5	90	14	3 1/2"	9/16"		10
05021605001	018656	2,0	100	16	4"	5/8"		10
05021610001	018663	2,5	112	18	4 7/16"	23/32"		10
05021615001	018670	3,0	126	20	5"	25/32"		10
05021620001	018687	4,0	140	25	5 1/2"	1"		10
05021625001	018694	5,0	160	28	6 5/16"	1 3/32"		10
05021630001	018700	6,0	180	32	7 1/16"	1 1/4"		10
05021632001	037701	7,0	190	30	7 1/2"	1 1/4"		10
05021635001	018717	8,0	200	36	8"	1 7/16"		10
05021640001	018724	10,0	219	40	8 11/16"	1 9/16"		5
05021645001	018731	12,0	250	45	10"	1 3/4"		5

¹⁾Regular hexagon.

950 L-key, metric, chrome-plated



	EAN	⊘	L ₁	L ₂	L ₃	L ₄		
Code	4013288	mm	mm	mm				
05021005001 ¹⁾	018267	1,5	45	14	1 3/4"	9/16"		10
05021010001	018274	2,0	50	16	2"	5/8"		10
05021015001	018281	2,5	56	18	2 7/32"	23/32"		10
05021020001	018298	3,0	63	20	2 1/2"	25/32"		10
05021025001	018304	3,5	66	23	2 5/8"	29/32"		10
05021030001	018311	4,0	70	25	2 3/4"	1"		10
05021035001	018328	4,5	75	26	3"	1 1/32"		10
05021040001	018335	5,0	80	28	3 1/8"	1 3/32"		10
05021045001	018342	6,0	90	32	3 1/2"	1 1/4"		10
05021050001	018359	7,0	95	34	3 3/4"	1 5/16"		10
05021055001	018366	8,0	100	36	4"	1 7/16"		10
05021060001	018373	9,0	106	38	4 3/16"	1 1/2"		10
05021065001	018380	10,0	112	40	4 7/16"	1 9/16"		10
05021070001	018397	11,0	120	43	4 3/4"	1 11/16"		10
05021075001	018403	12,0	125	45	5"	1 3/4"		10
05021080001	018410	13,0	132	50	5 3/16"	2"		10
05021085001 ¹⁾	018427	14,0	140	56	5 1/2"	2 7/32"		10
05021090001 ¹⁾	018434	17,0	160	63	6 5/16"	2 1/2"		5
05021095001 ¹⁾	018441	19,0	180	70	7 1/16"	2 3/4"		5

¹⁾Regular hexagon.



950 BM L-key, metric, BlackLaser



Code	EAN	Ø	L ₁	L ₂	L ₃	L ₄		
05027201001 ¹⁾	095381	1,5	45	14	1 3/4"	9/16"		10
05027202001	095398	2,0	50	16	2"	5/8"		10
05027203001	095541	2,5	56	18	2 7/32"	23/32"		10
05027204001	095404	3,0	63	20	2 1/2"	25/32"		10
05027205001	095411	3,5	66	23	2 5/8"	29/32"		10
05027206001	095428	4,0	70	25	2 3/4"	1"		10
05027207001	095435	4,5	75	26	3"	1 1/32"		10
05027208001	095442	5,0	80	28	3 1/8"	1 3/32"		10
05027209001	095459	6,0	90	32	3 1/2"	1 1/4"		10
05027210001	095466	7,0	95	34	3 3/4"	1 5/16"		10
05027211001	095473	8,0	100	36	4"	1 7/16"		10
05027213001	095480	9,0	106	38	4 11/64"	1 1/2"		10
05027212001	095497	10,0	112	40	4 7/16"	1 9/16"		10
05027214001	095503	11,0	120	43	4 23/32"	1 11/16"		10
05027215001	095510	12,0	125	45	5"	1 49/64"		10

¹⁾Regular hexagon

Kraftform Stainless - stainless steel to prevent rust



Set of high quality stainless steel L-keys for internal TORX® screws. Very corrosion-resistant due to ice-hardened stainless steel material of the L-key, avoiding the transmission of extraneous rust in stainless steel screw connections.

With holding function on the long arm: The clamping force resulting from the surface pressure between the output tip and the screw profile holds the screws securely on the tool.

With extra long arm for working in a low position.

The grip-friendly hose jacket facilitates screwdriving even at low temperatures. Take it easy tool finder with colour coding by size.

With a practical clip made of durable material for secure holding of the L-key while at the same time allowing easy removal.

- The holding function on the long arm keeps screws securely on the tool
- Extremely high corrosion protection thanks to ice-hardened stainless steel design
- Compact and easy to remove - stored in a 2-component plastic clip
- Handle-friendly hose jacket with tool finder Take it easy: Colour coding according to size

TORX® Tools with holding function



3967/9 TX SXL Multicolour HF Stainless 1 L-key set with holding function, stainless



	Code	EAN		
	05022689001	4013288 207128		1
			3967 SXL HF TORX® Multicolour 1x TX 8x90; 1x TX 9x101; 1x TX 10x112; 1x TX 15x123; 1x TX 20x137; 1x TX 25x154; 1x TX 27x172; 1x TX 30x195; 1x TX 40x224	

967/9 TX XL Multicolour HF 1 L-key set with holding function, long

- Holding function for recessed TORX® screws
- Long version
- Take it easy tool finder with colour coding according to sizes

967/9 TX XL Multicolour HF 1 L-key set with holding function, long



	Code	EAN		
	05024470001	4013288 193537		1
			967 SXL TORX® HF Multicolour 1x TX 8x90; 1x TX 9x101; 1x TX 10x112; 1x TX 15x123; 1x TX 20x137; 1x TX 25x154; 1x TX 27x172; 1x TX 30x195; 1x TX 40x224	

967/9 TX Multicolour HF 1 L-key set with holding function

- Holding function for recessed TORX® screws
- Take it easy tool finder with colour coding according to sizes

967/9 TX Multicolour HF 1 L-key set with holding function



	Code	EAN		
	05024179001	4013288 185228		1
			967 SL TORX® HF 1x TX 8x76; 1x TX 9x79; 1x TX 10x85; 1x TX 15x90; 1x TX 20x96; 1x TX 25x104; 1x TX 27x112; 1x TX 30x122; 1x TX 40x132	

967/9 TX XL HF 1 L-key set with holding function, long

- Holding function for recessed TORX® screws
- Long version

967/9 TX XL HF 1 L-key set with holding function, long



	Code	EAN		
	05024450001	4013288 193513		1
			967 XL HF TORX® 1x TX 8x90; 1x TX 9x101; 1x TX 10x112; 1x TX 15x123; 1x TX 20x137; 1x TX 25x154; 1x TX 27x172; 1x TX 30x195; 1x TX 40x224	

967/9 TX HF 1 L-key set with holding function, BlackLaser

- Holding function for recessed TORX® screws

967/9 TX HF 1 L-key set with holding function, BlackLaser



	Code	EAN		
	05024244001	4013288 104953		10
			967 L TORX® HF 1x TX 8x76; 1x TX 9x79; 1x TX 10x85; 1x TX 15x90; 1x TX 20x96; 1x TX 25x104; 1x TX 27x112; 1x TX 30x122; 1x TX 40x132	

967/9 TX XL Multicolour 1 Multicolour L-key set for TORX® screws, long



	Code	EAN		
	05024480001	4013288 193544		1
			967 SXL TORX® Multicolour 1x TX 8x90; 1x TX 9x101; 1x TX 10x112	
			967 SPKXL TORX® Multicolour 1x TX 15x123; 1x TX 20x137; 1x TX 25x154; 1x TX 27x172; 1x TX 30x195; 1x TX 40x224	



967/9 TX BO Multicolour 1 L-key set for tamper-proof TORX® screws, BlackLaser

- L-keys for TORX® BO screws to loosen safety connections

967/9 TX BO Multicolour 1 L-key set for tamper-proof TORX® screws, BlackLaser



Code	EAN		
	4013288		
05024335001	180858		10
		967 SPKL TORX® BO Multicolour 1x TX 8x76 ¹⁾ ; 1x TX 9x79 ¹⁾ ; 1x TX 10x85 ²⁾ ; 1x TX 15x90; 1x TX 20x96; 1x TX 25x104; 1x TX 27x112; 1x TX 30x122; 1x TX 40x132	

¹⁾Product without bore hole at the short and without ball-end at the long arm.
²⁾Product without ball-end at the long arm.

967/9 TX BO Multicolour 1 SB L-key set for tamper-proof TORX® screws, BlackLaser



Code	EAN		
	4013288		
05073599001	170125	967 SPKL TORX® BO Multicolour 1x TX 8x76 ¹⁾ 1x TX 9x79 ¹⁾ 1x TX 10x85 ²⁾ 1x TX 15x90 1x TX 20x96 1x TX 25x104 1x TX 27x112 1x TX 30x122 1x TX 40x132	1

¹⁾Product without bore hole at the short and without ball-end at the long arm.
²⁾Product without ball-end at the long arm.

967/9 TX XL 1 TORX® L-key set, long

- Long version

967/9 TX XL 1 TORX® L-key set, long



Code	EAN		
	4013288		
05024460001	193520		1
		967 XL TORX® 1x TX 8x90; 1x TX 9x101; 1x TX 10x112	
		967 PKXL TORX® 1x TX 15x123; 1x TX 20x137; 1x TX 25x154; 1x TX 27x172; 1x TX 30x195; 1x TX 40x224	

967/9 TX 1 L-key set, BlackLaser



Code	EAN		
	4013288		
05024242001	104946		10
		967 PKL TORX® 1x TX 8x76 ¹⁾ ; 1x TX 9x79 ¹⁾ ; 1x TX 10x85 ¹⁾ ; 1x TX 15x90; 1x TX 20x96; 1x TX 25x104; 1x TX 27x112; 1x TX 30x122; 1x TX 40x132	

¹⁾Product without ball-end at the long arm.

967/9 TX 1 SB L-key set, BlackLaser



Code	EAN		
	4013288		
05073598001	106438	967 PKL TORX® 1x TX 8x76 ¹⁾ 1x TX 9x79 ¹⁾ 1x TX 10x85 ¹⁾ 1x TX 15x90 1x TX 20x96 1x TX 25x104 1x TX 27x112 1x TX 30x122 1x TX 40x132	1

¹⁾Product without ball-end at the long arm.

Kraftform Stainless - stainless steel to prevent rust



3967 SXL HF TORX® L-key Multicolour with holding function, long, stainless



Code	EAN			L ₁	L ₂	L ₃	L ₄	
				mm	mm			
05022680001	207135		TX 8	90	16	3 1/2"	5/8"	10
05022681001	207142		TX 9	101	16	4"	5/8"	10
05022682001	207159		TX 10	112	19	4 7/16"	3/4"	10
05022683001	207166		TX 15	123	21	4 7/8"	27/32"	10
05022684001	207173		TX 20	137	24	5 3/8"	1"	10
05022685001	207180		TX 25	154	27	6 1/16"	1 1/16"	10
05022686001	207197		TX 27	172	31	6 3/4"	1 1/4"	10
05022687001	207203		TX 30	195	37	7 11/16"	1 7/16"	10
05022688001	207210		TX 40	224	42	9"	1 11/16"	10

967 SXL HF TORX® L-key Multicolour with holding function, long

- Holding function for recessed TORX® screws

967 SXL HF TORX® L-key Multicolour with holding function, long



Code	EAN			L ₁	L ₂	L ₃	L ₄	
				mm	mm			
05024471001	194145		TX 8	90	16	3 1/2"	5/8"	10
05024472001	194152		TX 9	101	16	4"	5/8"	10
05024473001	194169		TX 10	112	19	4 7/16"	3/4"	10
05024474001	194176		TX 15	123	21	4 7/8"	27/32"	10
05024475001	194183		TX 20	137	24	5 3/8"	1"	10
05024476001	194190		TX 25	154	27	6 1/16"	1 1/16"	10
05024477001	194206		TX 27	172	31	6 3/4"	1 1/4"	10
05024478001	194213		TX 30	195	37	7 11/16"	1 7/16"	10
05024479001	194220		TX 40	224	42	9"	1 11/16"	10

967 SPKXL TORX® L-key Multicolour, long

- Long design

967 SPKXL TORX® L-key Multicolour, long



Code	EAN			L ₁	L ₂	L ₃	L ₄	
				mm	mm			
05024484001	194305		TX 15	123	21	4 7/8"	27/32"	10
05024485001	194312		TX 20	137	24	5 3/8"	1"	10
05024486001	194329		TX 25	154	27	6 1/16"	1 1/16"	10
05024487001	194336		TX 27	172	31	6 3/4"	1 1/4"	10
05024488001	194343		TX 30	195	37	7 11/16"	1 7/16"	10
05024489001	194350		TX 40	224	42	9"	1 11/16"	10

967 SL TORX® HF L-key Multicolour with holding function

- Holding function for recessed TORX® screws

967 SL TORX® HF L-key Multicolour with holding function



Code	EAN			L ₁	L ₂	L ₃	L ₄	
				mm	mm			
05024170001	185235		TX 8	76	16	3"	5/8"	5
05024171001	185242		TX 9	79	16	3 1/8"	5/8"	5
05024172001	185259		TX 10	85	17	3 1/4"	21/32"	5
05024173001	185266		TX 15	90	18	3 1/2"	23/32"	5
05024174001	185273		TX 20	96	19	3 3/4"	3/4"	5
05024175001	185280		TX 25	104	21	4 1/8"	27/32"	5
05024176001	185297		TX 27	112	22	4 7/16"	29/32"	5
05024177001	185303		TX 30	122	24	4 13/16"	1"	5
05024178001	185310		TX 40	132	27	5 3/16"	1 1/16"	5



967 SPKL TORX® B0 L-key Multicolour

- L-key for TORX® socket screws with safety pin

967 SPKL TORX® B0 L-key Multicolour

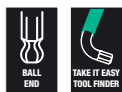

Code	EAN							
Code	4013288			mm	mm			
05024350001 ¹⁾	172679		TX 8	76	16	3"	5/8"	10
05024351001 ¹⁾	172686		TX 9	79	16	3 1/8"	5/8"	10
05024352001 ²⁾	172693		TX 10	85	17	3 3/8"	21/32"	10
05024353001	172709		TX 15	90	18	3 1/2"	23/32"	10
05024354001	172716		TX 20	96	19	3 3/4"	3/4"	10
05024355001	172723		TX 25	104	21	4 1/8"	27/32"	10
05024356001	172730		TX 27	112	22	4 7/16"	29/32"	10
05024357001	172747		TX 30	122	24	4 13/16"	1"	10
05024358001	172754		TX 40	132	27	5 3/16"	1 1/16"	10

¹⁾Product without bore hole at the short and without ball-end at the long arm.

²⁾Product without ball-end at the long arm.

967 SXL TORX® L-key Multicolour, long

- Long version

967 SXL TORX® L-key Multicolour, long



Code	EAN							
Code	4013288			mm	mm			
05024481001	194275		TX 8	90	16	3 1/2"	5/8"	10
05024482001	194282		TX 9	101	16	4"	5/8"	10
05024483001	194299		TX 10	112	19	4 7/16"	3/4"	10

967 XL HF TORX® L-key with holding function, long

- Holding function for recessed TORX® screws

967 XL HF TORX® L-key with holding function, long



Code	EAN						
Code	4013288		mm	mm			
05024451001	193674	TX 8	90	16	3 1/2"	5/8"	10
05024452001	193681	TX 9	101	16	4"	5/8"	10
05024453001	193698	TX 10	112	19	4 7/16"	3/4"	10
05024454001	193704	TX 15	123	21	4 7/8"	27/32"	10
05024455001	193711	TX 20	137	24	5 3/8"	1"	10
05024456001	193728	TX 25	154	27	6 1/16"	1 1/16"	10
05024457001	193735	TX 27	172	31	6 3/4"	1 1/4"	10
05024458001	193742	TX 30	195	37	7 11/16"	1 7/16"	10
05024459001	193759	TX 40	224	42	9"	1 11/16"	10

967 PKXL TORX® L-key, long

- TORX® ballpoint on the long arm

967 PKXL TORX® L-key, long



Code	EAN						
Code	4013288		mm	mm			
05024464001	194084	TX 15	123	21	4 7/8"	27/32"	10
05024465001	194091	TX 20	137	24	5 3/8"	1"	10
05024466001	194107	TX 25	154	27	6 1/16"	1 1/16"	10
05024467001	194114	TX 27	172	31	6 3/4"	1 1/4"	10
05024468001	194121	TX 30	195	37	7 11/16"	1 7/16"	10
05024469001	194138	TX 40	224	42	9"	1 1/16"	10

967 XL TORX® L-key, long

- Long design

967 XL TORX® L-key, long



	EAN						
Code	4013288		mm	mm			
05024461001	194053	TX 8	90	16	3 1/2"	5/8"	10
05024462001	194060	TX 9	101	16	4"	5/8"	10
05024463001	194077	TX 10	112	19	4 7/16"	3/4"	10

967 PKL TORX® L-key, BlackLaser

- TORX® ballpoint on the long arm



	EAN						
Code	4013288		mm	mm			
05024199001 ¹⁾	104939	TX 8	76	16	3"	5/8"	5
05024100001 ¹⁾	035035	TX 9	79	16	3 1/8"	5/8"	5
05024105001 ¹⁾	019431	TX 10	85	17	3 3/8"	21/32"	5
05024200001	019547	TX 15	90	18	3 1/2"	23/32"	5
05024202001	019554	TX 20	96	19	3 3/4"	3/4"	5
05024204001	019561	TX 25	104	21	4 1/8"	27/32"	5
05024206001	019578	TX 27	112	22	4 7/16"	29/32"	5
05024208001	019585	TX 30	122	24	4 13/16"	1"	5
05024210001	019592	TX 40	132	27	5 3/16"	1 1/16"	5

¹⁾Product without ball-end at the long arm.

967 L TORX® HF L-key with holding function, BlackLaser

- Holding function for recessed TORX® screws



	EAN						
Code	4013288		mm	mm			
05024160001	104847	TX 8	76	16	3"	5/8"	5
05024161001	104922	TX 9	79	16	3 1/8"	5/8"	5
05024162001	104854	TX 10	85	17	3 1/4"	21/32"	5
05024163001	104861	TX 15	90	18	3 1/2"	23/32"	5
05024164001	104878	TX 20	96	19	3 3/4"	3/4"	5
05024165001	104885	TX 25	104	21	4 1/8"	27/32"	5
05024166001	104892	TX 27	112	22	4 7/16"	29/32"	5
05024167001	104908	TX 30	122	24	4 13/16"	1"	5
05024168001	104915	TX 40	132	27	5 3/16"	1 1/16"	5

967 TORX® L-key, BlackLaser



	EAN						
Code	4013288		mm	mm			
05024001001	019257	TX 6	42	16	1 5/8"	5/8"	5
05024002001	019264	TX 7	48	16	1 7/8"	5/8"	5
05024003001	019271	TX 8	48	16	1 7/8"	5/8"	5
05024004001	019288	TX 9	48	16	1 7/8"	5/8"	5
05024005001	019295	TX 10	51	17	2"	21/32"	5
05024008001	019301	TX 15	54	18	2 1/8"	23/32"	5
05024010001	019318	TX 20	57	19	2 1/4"	3/4"	5
05024012001	019325	TX 25	60	20	2 3/8"	25/32"	5
05024013001	019332	TX 27	64	21	2 1/2"	27/32"	5
05024015001	019349	TX 30	70	24	2 3/4"	1"	5
05024020001	019356	TX 40	76	26	3"	1 1/32"	5





Kraftform Kompakt



Kraftform Kompakt Turbo 1

Many users would like to be able to carry out screwdriving processes faster without compromise. With a screwdriver that is precise, allows powerful screwdriving, and is much faster than a conventional screwdriver.

A part-time universal gear is the solution: Integrated in the screwdriver handle, it quadruples the working speed with smooth couplings - purely mechanically.

One hand holds the front part of the handle, the other hand turns the rear part of the handle. The turbo function can be switched on or off at the push of a button.

Turning it off is recommended for tightening and loosening with high torque, e.g. for screw connections in wood, as well as for fine adjustments. Robust, maintenance-free gear made of steel with a maximum torque of 14Nm when the turbo function is deactivated.

Thanks to the Rapidaptor bit holder, the Kraftform Turbo can be used with all conventional 1/4" hexagon bits for a wide variety of screw profiles.

With the Rapidaptor function the bits can be inserted directly and can be easily removed by pushing the sleeve forward.

- 4 times the screwdriving speed thanks to the turbo function (purely mechanical - without battery)
- Activate and deactivate the turbo function by a simple push of a button
- Turbo function especially for smooth couplings
- Can be used without the turbo function like a normal screwdriver, e.g. for timber couplings with steadily increasing torque
- Robust, maintenance-free gear made of steel

Kraftform Kompakt Turbo 1



Code	EAN		
05057482001	4013288 214614		1
		● 826 T Kraftform Turbo 1x 1/4"x146	
		⊕ 851/4 Z PH 1x PH 1x89; 1x PH 2x89; 1x PH 3x89	
		⊕ 855/4 Z PZ 1x PZ 1x89; 1x PZ 2x89; 1x PZ 3x89	
		⊗ 867/4 Z TORX® 1x TX 10x89; 1x TX 15x89; 1x TX 20x89; 1x TX 25x89; 1x TX 30x89	
		○ 840/4 Z Hex-Plus 1x 3,0x89; 1x 4,0x89; 1x 5,0x89; 1x 6,0x89	
		● 800/4 Z 1x 0,8x4,0x89; 1x 1,0x5,5x89; 1x 1,2x6,5x89	

Kraftform Kompakt Turbo Imperial 1



Code	EAN		
05057483001	4013288 214621		1
		● 826 T Kraftform Turbo 1x 1/4"x146	
		⊕ 851/4 Z PH 1x PH 1x89; 1x PH 2x89; 1x PH 3x89	
		⊗ 867/4 Z TORX® 1x TX 10x89; 1x TX 15x89; 1x TX 20x89; 1x TX 25x89; 1x TX 30x89	
		○ 840/4 Z Hex-Plus 1x 3/32"x89; 1x 1/8"x89; 1x 5/32"x89; 1x 3/16"x89	
		□ 868/4 Square-Plus 1x # 1x89; 1x # 2x89; 1x # 3x89	
		● 800/4 Z 1x 0,8x4,0x89; 1x 1,0x5,5x89; 1x 1,2x6,5x89	

826 T Kraftform Turbo bits handholder with Rapidaptor quick-release chuck

- 4 times the screwdriving speed thanks to the turbo function (purely mechanical - without battery)
- Activate and deactivate the turbo function by a simple push of a button
- Turbo function especially for smooth couplings
- Can be used without the turbo function like a normal screwdriver, e.g. for timber couplings with steadily increasing torque
- Robust, maintenance-free gear made of steel

826 T Kraftform Turbo bits handholder with Rapidaptor quick-release chuck



	EAN								
Code	4013288		mm						
05057480001	214591	1/4"	146						1

Kraftform Kompakt 10, 12

9 tough viscous Wera bits for universal use. Torsion design to combat premature wear.

1 holder 813 R Kraftform with Rapidaptor quick-release chuck; multi-component for high working speeds and particularly ergonomic screwdriving.

- Kraftform holder with Rapidaptor quick-release chuck
- Torsion design of the bits against premature wear
- Tough viscous bits for universal use
- Convenient and robust storage

Kraftform Kompakt 10



	Code	EAN			
	05056653001	041647			1
		813 R			
		1x 1/4"x90			
		851/1 TZ PH			
		1x PH 1x25; 1x PH 2x25			
		855/1 TZ PZ			
		1x PZ 1x25; 1x PZ 2x25			
		867/1 TZ TORX®			
		1x TX 10x25; 1x TX 15x25; 1x TX 20x25			
		800/1 TZ			
		1x 0,5x4,0x25; 1x 1,0x5,5x25			

Kraftform Kompakt 12



	Code	EAN			
	05135942001	155887			1
		813 R			
		1x 1/4"x90			
		851/1 J			
		1x PH 00x25x2,0 ¹⁾ ; 1x PH 0x25x2,5 ²⁾ ; 1x PH 1x25x3,0			
		851/1 TZ PH			
		1x PH 2x25			
		867/1 TZ TORX®			
		1x TX 5x25; 1x TX 6x25; 1x TX 7x25; 1x TX 8x25; 1x TX 9x25			

¹⁾ Size 00 modified according to JCS 00 (Japanese Camera Industrial Standard)

²⁾ Size 0 modified according to JCS 0 (Japanese Camera Industrial Standard)

Kraftform Kompakt 20 - the right tool for machine or hand

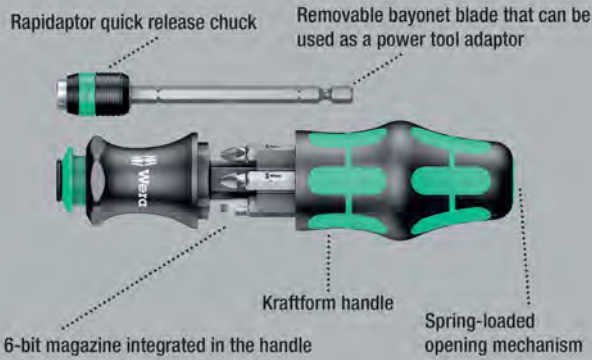

Wera compact tools enable the simultaneous use for the two types of fastening “manual” and “power tool”. The handle/interchangeable system in a compact design with various blade tips in a minimum of space make the user mobile and flexible.

Suitable for bits with 1/4" hexagon head drive as per DIN ISO 1173-C 6.3 und E 6.3 (ISO 1173) and Wera connecting series 1 and 4. Comes with an extension, bayonet, Rapidaptor technology.

Kraftform handle with non-roll feature, multi-component for particularly ergonomic screwdriving. Integrated magazine for the storage of the bits. In this way, this set replaces a 6-piece screwdriver set and reduces the equipment required to a minimum.

The profile and size of the bits are easy to recognise thanks to the Wera Take it easy Tool Finder with its colour coding and clearly visible imprint.

- Kraftform holder with bayonet blade and Rapidaptor quick-release chuck
- Kraftform handle with anti-roll feature, multi-component and integrated magazine
- Retractable bayonet blade
- Take it easy tool finder: colour coding according to profile and size
- In robust pouch

Take it easy tool finder with color markings - for quick tool identification



Kraftform Kompakt 20 Tool Finder 1 with pouch



Code	EAN		
05051016001	4013288 185327		1
		889/4 R 1x 1/4"x100	
		851/1 BTZ PH 1x PH 1x25; 1x PH 2x25	
		855/1 BTZ PZ 1x PZ 1x25; 1x PZ 2x25	
		867/1 TORX® BTZ 1x TX 25x25	
		800/1 BTZ 1x 0,8x5,5x25	

Kraftform Kompakt 20 Tool Finder 2 with pouch

13-piece Kraftform Kompakt set with 6x 25mm long and 6x 89mm long bits. Wera's compact tools allow the simultaneous use of both types of screw connections; “hand” or “machine”.

The handle blade-change system in a compact design with different compact blade tips makes the user mobile and flexible. Suitable for bits with 1/4" hexagonal drive as per DIN ISO 1173-C 6.3 and E 6.3 (ISO 1173) and Wera connection series 1 and 4.

With connecting adapter, bayonet, Rapidaptor technology, Kraftform handle with anti-roll protection, multi-components allow for particularly ergonomic screwdriving. Integrated magazine for storing 25mm long bits.

This set replaces a 12-piece screwdriver set and reduces the necessary equipment to a minimum.

Profile and size of the bits are easily recognizable due to the Wera Take it easy tool finder with its colour coding and easily visible labels.

- 6x25mm bits with Take it easy tool finder: colour coding by profile and size stamping and 6x89mm bits

Kraftform Kompakt 20 Tool Finder 2 with pouch



Code	EAN			
05051017001	4013288 211224			1
		●○	889/4 R 1x 1/4"x100	
		+	851/1 BTZ PH 1x PH 1x25; 1x PH 2x25	
		+	855/1 BTZ PZ 1x PZ 1x25; 1x PZ 2x25	
		✦	867/1 TORX® BTZ 1x TX 20x25; 1x TX 25x25	
		+	851/4 Z PH 1x PH 1x89; 1x PH 2x89	
		+	855/4 Z PZ 1x PZ 1x89; 1x PZ 2x89	
		✦	867/4 Z TORX® 1x TX 20x89; 1x TX 25x89	

Kraftform Kompakt 20 A

- Tough viscous bits for universal use

Kraftform Kompakt 20 A

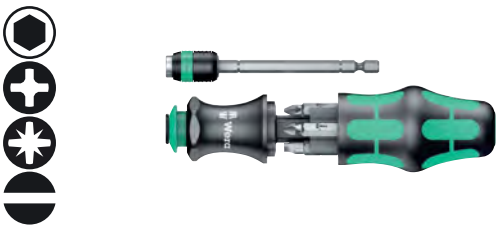

Code	EAN			
05051019001	4013288 100528			1
		●○	889/4 R 1x 1/4"x100	
		+	851/1 Z PH 1x PH 1x25; 1x PH 2x25	
		+	855/1 Z PZ 1x PZ 1x25; 1x PZ 2x25	
		●	800/1 Z 1x 1,0x5,5x25; 1x 1,2x6,5x25	

Kraftform Kompakt 20 with pouch



Code	EAN			
05051021001	4013288 098917			1
		●○	889/4 R 1x 1/4"x100	
		+	851/1 Z PH 1x PH 1x25; 1x PH 2x25	
		+	855/1 Z PZ 1x PZ 1x25; 1x PZ 2x25	
		●	800/1 Z 1x 1,0x5,5x25; 1x 1,2x6,5x25	

Kraftform Kompakt 22 with pouch



Code	EAN			
05051023001	4013288 098924			1
		●○	889/4 R 1x 1/4"x100	
		+	855/1 Z PZ 1x PZ 1x25; 2x PZ 2x25	
		✦	867/1 TORX® 1x TX 15x25; 1x TX 20x25; 1x TX 25x25	

Kraftform Kompakt 25 with pouch



	Code	EAN		
	05051024001	4013288 098931		1
			889/4 R 1x 1/4"x100	
			851/1 Z PH 1x PH 1x25; 1x PH 2x25; 1x PH 3x25	
			800/1 Z 1x 0,6x4,5x25; 1x 1,0x5,5x25; 1x 1,2x6,5x25	

Kraftform Kompakt 26 with pouch



	Code	EAN		
	05051025001	4013288 098948		1
			889/4 R 1x 1/4"x100	
			851/1 Z PH 1x PH 1x25; 1x PH 2x25	
			800/1 Z 1x 1,0x5,5x25; 1x 1,2x6,5x25	
			868/1 Z 1x # 1x25; 1x # 2x25	

Kraftform Kompakt 27 Set 1

Wera compact tools with multi-component Kraftform handle for high working speeds and particularly ergonomic screwdriving. Bit magazine integrated in the handle, 6 bits with Torsion zone to prevent the bit tip from twisting at high loads. This significantly increases product life.

With Take it easy tool finder: Colour coding by profile and size stamping. Bit holder with strong permanent magnet for secure seating of the bit.

- Bit-holding handle with bit magazine
- Bit holder with strong permanent magnet which holds bits firmly
- With 6 BiTorsion bits in the magazine: Phillips-head Phillips and Pozidriv, TORX® and slotted; tough
- Take it easy tool finder: colour coding according to profile and size

Kraftform Kompakt 27 Set 1



	Code	EAN		
	05051510001	4013288 226556		1
			828/1 1x 1/4"	
			851/1 BTZ 1x PH 1x25; 1x PH 2x25	
			855/1 BTZ 1x PZ 2x25	
			867/1 TORX® BTZ 1x TX 20x25; 1x TX 25x25	
			800/1 BTZ 1x 0,8x5,5x25	

Kraftform Kompakt 27 Set 2

- With 6 bits in the magazine: Phillips-head Phillips and slotted; tough

Kraftform Kompakt 27 Set 2



Code	EAN			
05051511001	4013288 226587			1
		●	828/1 1x 1/4"	
		+	851/1 Z 1x PH 1x25; 1x PH 2x25; 1x PH 3x25	
		—	800/1 Z 1x 0,6x4,5x25; 1x 1,0x5,5x25; 1x 1,2x6,5x25	

Kraftform Kompakt 27 Imperial Set 1

- With 6 bits in the magazine: Phillips-head Phillips, slotted and square head (Robertson); tough

Kraftform Kompakt 27 Imperial Set 1



Code	EAN			
05051512001	4013288 226594			1
		●	828/1 1x 1/4"	
		+	851/1 Z 1x PH 1x25; 1x PH 2x25	
		—	800/1 Z 1x 1,0x5,5x25; 1x 1,2x6,5x25	
		□	868/1 Z 1x # 1x25; 1x # 2x25	

Kraftform Kompakt 28 SB

Wera compact tool with multi-component Kraftform handle for high working speeds and particularly ergonomic screwdriving. Integrated bit magazine in the handle for the storage of 6 bits.

The bayonet blade can be lowered into the handle in confined screwdriving situations; it can be removed for insertion in a power tool. The retaining ring and the strong permanent magnet ensure a secure fit of the bit.

- Adaptor bayonet with stainless sleeve, retaining ring and strong permanent magnet
- Tough viscous bits for universal use

Kraftform Kompakt 28 SB

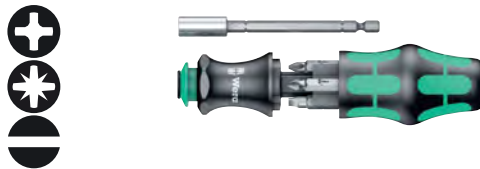

Code	EAN			
05073240001	4013288 138927			1
		+	851/1 Z PH 1x PH 1x25; 1x PH 2x25	
		+	855/1 Z PZ 1x PZ 1x25; 1x PZ 2x25	
		—	800/1 Z 1x 1,0x5,5x25; 1x 1,2x6,5x25	

Kraftform Kompakt 28 Imperial 1

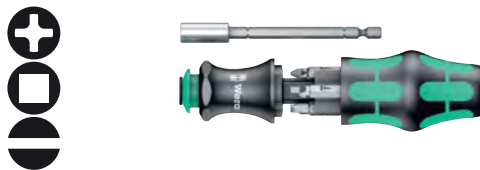

Code	EAN			
05073241001	4013288 214676			1
		+	851/1 Z PH 1x PH 1x25; 1x PH 2x25	
		□	868/1 Z 1x # 1x25; 1x # 2x25	
		—	800/1 Z 1x 1,0x5,5x25; 1x 1,2x6,5x25	



Kraftform Kompakt 28 with pouch



Code		EAN		
		4013288		
05134491001	175373			1
		+	851/1 Z PH 1x PH 1x25; 1x PH 2x25	
		+	855/1 Z PZ 1x PZ 1x25; 1x PZ 2x25	
		-	800/1 Z 1x 1,0x5,5x25; 1x 1,2x6,5x25	

Kraftform Kompakt 40 and 41

- Pouch with 89 mm-long bits
- Kraftform holder with Rapidaptor quick-release chuck
- Rapidaptor quick-release chuck allows rapid bit change
- Tough viscous bits for universal use
- Ergonomic Kraftform handle for low-fatigue working

Kraftform Kompakt 40



Code		EAN		
		4013288		
05059298001	096319			1
		●	816 R 1x 1/4"x119	
		+	851/4 Z PH 1x PH 1x89; 1x PH 2x89	
		+	855/4 Z PZ 1x PZ 1x89; 1x PZ 2x89	
		-	800/4 Z 1x 1,0x5,5x89; 1x 1,2x6,5x89	

Kraftform Kompakt 41



05059299001	096326			1
		●	816 R 1x 1/4"x119	
		+	851/4 Z PH 1x PH 1x89; 1x PH 2x89; 1x PH 3x89	
		+	855/4 Z PZ 1x PZ 1x89; 1x PZ 2x89; 1x PZ 3x89	
		+	867/4 Z TORX® B0 1x TX 15x89; 1x TX 20x89; 1x TX 25x89; 1x TX 30x89	

Kraftform Kompakt 60 Torque 1.2 - 3.0 Nm

Pouch with bits in a length of 89 mm. Includes torque screwdriver 7441 with Rapidaptor quick-release chuck and multi-component Kraftform handle for low-fatigue working. Suitable for manual and power tool operations. 17-piece; compact handle/interchangeable blade system for torque-controlled tightening. Includes torque holder 7441, settings from 1.2 to 3.0 Nm. Adjustable in 0.10 Nm steps.

Simple setting of the required torque value without any special tools. Easy-to-read scale value. Rapidaptor quick-release technology for rapid bit change. Unlimited torque to loosen seized screws.

Multi-component Kraftform handle with hard and soft zones for high working speeds, whilst being easy on the hand. Includes 16 bits with a length of 89 mm and a practical pouch for tidy storage.

- Adjustable Kraftform torque screwdriver with Rapidaptor quick-release chuck
- Multi-component Kraftform handle for fast and ergonomic screwdriving
- Rapidaptor technology for rapid bit change
- Suitable for manual and power tool operations
- Practical pouch for tidy storage

Kraftform Kompakt 60 Torque 1.2 - 3.0 Nm



Code	EAN		
05059293001	169624		1
		7400 1x 7441, 1/4", 1,2-3,0 Nm	
		851/4 Z PH 1x PH 1x89; 1x PH 2x89; 1x PH 3x89	
		855/4 Z PZ 1x PZ 1x89; 1x PZ 2x89; 1x PZ 3x89	
		867/4 Z TORX® B0 1x TX 10x89; 1x TX 15x89; 1x TX 20x89; 1x TX 25x89; 1x TX 30x89	
		800/4 Z 1x 1,0x5,5x89	
		840/4 Z Hex-Plus 1x 3,0x89; 1x 4,0x89; 1x 5,0x89; 1x 6,0x89	

Kraftform Stainless - stainless steel to prevent rust

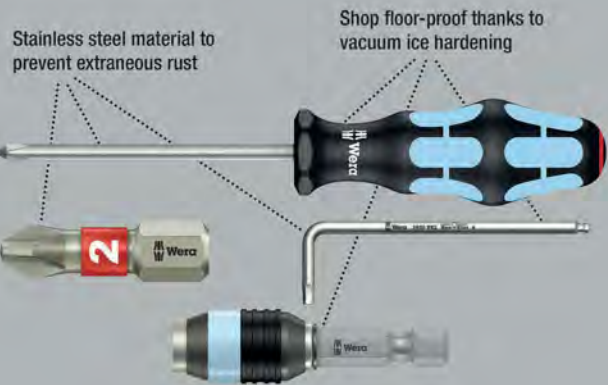

Pouch with bits in a length of 89 mm. Includes Kraftform holder 3816 R with Rapidaptor quick-release chuck and multi-component Kraftform handle for low-fatigue working. Stainless design to prevent the formation of extraneous rust.

Kraftform Kompakt 60, stainless



Code	EAN		
05071116001	4013288 115713		1
		3816 R 1x 1/4"x119	
		3851/4 1x PH 1x89; 1x PH 2x89; 1x PH 3x89	
		3855/4 1x PZ 1x89; 1x PZ 2x89; 1x PZ 3x89	
		3867/4 TORX® B0 1x TX 10x89; 1x TX 15x89; 1x TX 20x89; 1x TX 25x89; 1x TX 30x89	
		3800/4 1x 1,0x5,5x89	
		3840/4 Hex-Plus 1x 3,0x89; 1x 4,0x89; 1x 5,0x89; 1x 6,0x89	



Kraftform Kompakt 60, imperial, stainless



Code	EAN		
05071117001	115720		1
		3816 R 1x 1/4"x119	
		3851/4 1x PH 1x89; 1x PH 2x89; 1x PH 3x89	
		3867/4 TORX® B0 1x TX 10x89; 1x TX 15x89; 1x TX 20x89; 1x TX 25x89; 1x TX 30x89	
		3800/4 1x 1,0x5,5x89	
		3840/4 Hex-Plus 1x 3/32"x89; 1x 1/8"x89; 1x 5/32"x89; 1x 3/16"x89	
		3868/4 Square-Plus 1x # 1x89; 1x # 2x89; 1x # 3x89	

Kraftform Kompakt 60 Tool Finder

Folding pouch with 89 mm long bits. Including 816 R Kraftform bitholding screwdriver with Rapidaptor quick-release chuck and multi-component Kraftform handle for fatigue-free working. Hard handle zones for high working speeds, while soft handle zones guarantee a high torque transfer.

Profile and size of the bits are easily recognized thanks to the Wera Take it easy tool finder with its colour codes and labels. Suitable for manual and machine operated couplings. 17-piece set.

- Take it easy tool finder: colour coding according to profile and size

Kraftform Kompakt 60 Tool Finder



Code	EAN		
05059303001	226396		1
		816 R 1x 1/4"x119	
		851/4 Z PH Take it easy 1x PH 1x89; 1x PH 2x89	
		851/4 PH Ni 1x PH 3x89	
		855/4 Z PZ Take it easy 1x PZ 1x89; 1x PZ 2x89	
		855/4 PZ Ni 1x PZ 3x89	
		867/4 Z TORX® B0 Take it easy 1x TX 10x89; 1x TX 15x89; 1x TX 20x89; 1x TX 25x89; 1x TX 30x89	
		840/4 Z Hex-Plus Take it easy 1x 3,0x89; 1x 4,0x89; 1x 5,0x89	
		840/4 Hex-Plus Ni 1x 6,0x89	
		800/4 Z Take it easy 1x 1,0x5,5x89	
		Hook and Loop Fastener Strip 70 1x 50,0x70,0	

Kraftform Kompakt 60

Pouch with 89-mm long bits. Includes 816 R Kraftform holder with Rapidaptor quick-release chuck and multi-component Kraftform handle for low-fatigue working.

Hard gripping zones for high working speeds whereas soft zones ensure high torque transfer. Suitable for manual and power tool operations; 17-piece.

Kraftform Kompakt 60



Code	EAN			
05059295001	096289			1
		●	816 R 1x 1/4"x119	
		+	851/4 Z PH 1x PH 1x89; 1x PH 2x89; 1x PH 3x89	
		+	855/4 Z PZ 1x PZ 1x89; 1x PZ 2x89; 1x PZ 3x89	
		⊕	867/4 Z TORX® BO 1x TX 10x89; 1x TX 15x89; 1x TX 20x89; 1x TX 25x89; 1x TX 30x89	
		⊖	800/4 Z 1x 1,0x5,5x89	
		○	840/4 Z Hex-Plus 1x 3,0x89; 1x 4,0x89; 1x 5,0x89; 1x 6,0x89	

Kraftform Kompakt 60, imperial



Code	EAN			
05051042001	156037			1
		●	816 R 1x 1/4"x119	
		+	851/4 Z PH 1x PH 1x89; 1x PH 2x89; 1x PH 3x89	
		⊕	867/4 Z TORX® BO 1x TX 10x89; 1x TX 15x89; 1x TX 20x89; 1x TX 25x89; 1x TX 30x89	
		⊖	800/4 Z 1x 1,0x5,5x89	
		○	840/4 Z Hex-Plus 1x 3/32"x89; 1x 1/8"x89; 1x 5/32"x89; 1x 3/16"x89	
		□	868/4 Square-Plus 1x # 1x89; 1x # 2x89; 1x # 3x89	

Kraftform Kompakt 60 KK

- Ballpoint bits allow a swivelling of the tool axis

Kraftform Kompakt 60 KK



Code	EAN			
05059294001	165503			1
		●	816 R 1x 1/4"x119	
		+	851/4 Z PH 1x PH 1x89; 1x PH 2x89; 1x PH 3x89	
		+	855/4 Z PZ 1x PZ 1x89; 1x PZ 2x89; 1x PZ 3x89	
		⊕	867/4 KK 1x TX 10x89; 1x TX 15x89; 1x TX 20x89; 1x TX 25x89; 1x TX 30x89; 1x TX 40x89	
		○	842/4 1x 3,0x89; 1x 4,0x89; 1x 5,0x89; 1x 6,0x89	

Kraftform Kompakt 62



Code	EAN		
05059297001	4013288 096302		1
		816 R 1x 1/4"x119	
		851/4 Z PH 1x PH 1x89; 1x PH 2x89; 1x PH 3x89	
		855/4 Z PZ 1x PZ 1x89; 1x PZ 2x89; 1x PZ 3x89	
		867/4 Z TORX® B0 1x TX 8x89; 1x TX 10x89; 1x TX 15x89; 1x TX 20x89; 1x TX 25x89; 1x TX 27x89; 1x TX 30x89; 1x TX 40x89	
		840/4 Z Hex-Plus B0 1x 2,0x89; 1x 2,5x89; 1x 3,0x89; 1x 4,0x89; 1x 5,0x89; 1x 6,0x89	
		800/4 Z 1x 1,2x6,5x89	
		871/4 TORQ-SET® Mplus 1x 6x89; 1x 8x89; 1x 10x89	
		875/4 TRI-WING® 1x 1x89; 1x 2x89; 1x 3x89; 1x 4x89	
		857/4 Z Spanner 1x 4x89; 1x 6x89; 1x 8x89; 1x 10x89	

Bicycle Set 2

Bicycle tool set in practical pouch with 89 mm long bits. Including 816 R Kraftform bit hand-holder with Rapidaptor quick-release chuck and multi-component Kraftform handle for fatigue-free working.



Code	EAN		
05004171001	4013288 211439		1
		816 R 1x 1/4"x119	
		851/4 Z PH 1x PH 1x89; 1x PH 2x89	
		867/4 Z TORX® 1x TX 10x89; 1x TX 20x89; 1x TX 25x89; 1x TX 30x89	
		840/4 Z Hex-Plus 1x 2,0x89; 1x 2,5x89; 1x 3,0x89; 1x 4,0x89; 1x 5,0x89; 1x 6,0x89	
		K70 1x 50,0x70,0	

Kraftform Kompakt 100

52-piece; in surface-protecting, compact textile box which is extremely robust. Low volume and weight for simplified mobility. Compact tool set with 52 screwdriving tools.

1 bit holder Rapidaptor with quick-release chuck; 1 B bit holder Rapidaptor with quick-release chuck for take-up in the power screwdriver or use in the chuck of the power drill; 30 BiTorsion bits with a length of 25 mm for long service life, tough-absorbing (BTZ), for universal use, extra hard (BTH), 12 Impaktor bits with a length of 50 mm for particularly demanding jobs, 8 L-keys with Hex-Plus profile (prevents the rounding of socket head screws) and hexagonal ballpoint on the long arm for working at angles; textile box that is very robust and durable; can be positioned upright for tidy storage on the workshop shelf; additional surface protection thanks to the outer textile material.

- Robust surface-protecting, compact, textile box
- Rapidaptor technology for rapid bit change
- BiTorsion bits in a length of 25 mm for long service life
- Impaktor bits in a length of 50 mm for particularly demanding jobs
- L-keys with Hex-Plus profile (prevents the rounding of hexagon socket screws)

Hex-Plus - lets hexagon socket screws last longer

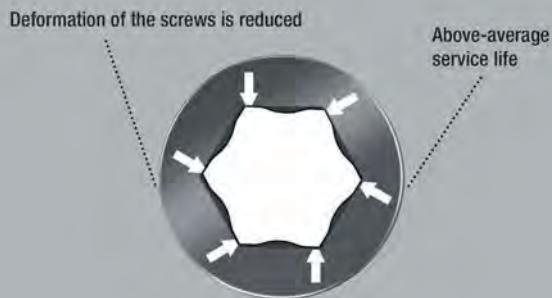

Kraftform Kompakt 100



Code	EAN		
	4013288		
05057460001	179968		1
		813 R 1x 1/4"x90	
		889/4/1 K 1x 1/4"x50	
		851/1 BTZ PH 2x PH 1x25; 4x PH 2x25; 2x PH 3x25	
		851/4 IMP DC 2x PH 2x50; 1x PH 3x50	
		855/1 BTH PZ 2x PZ 1x25; 4x PZ 2x25; 2x PZ 3x25	
		855/4 IMP DC 2x PZ 2x50; 1x PZ 3x50	
		867/1 TORX® BTZ 2x TX 10x25; 2x TX 15x25; 3x TX 20x25; 2x TX 25x25; 2x TX 30x25; 1x TX 40x25	
		867/4 IMP DC 1x TX 25x50; 1x TX 30x50; 1x TX 40x50	
		800/1 BTZ 1x 0,8x5,5x25; 1x 1,0x5,5x25	
		840/4 IMP DC 1x 4,0x50; 1x 5,0x50; 1x 6,0x50	
		950 PKS 1x 1,5x50 ¹⁾ ; 1x 2,0x56; 1x 2,5x63; 1x 3,0x71; 1x 4,0x80; 1x 5,0x90; 1x 6,0x100; 1x 8,0x112	

¹⁾Regular hexagon

Kraftform Kompakt 400

T-handle screwdriver: The ideal handle shape to allow high torque transmission in difficult tightening and loosening situations. The ergonomic shape of the handle fills the palm of the hand well, the fingers lie safely in the soft rounded handle recesses.

The whole hand makes contact with the handle and friction losses between the hand and the handle are avoided. Special surface treatment of the blades for high corrosion protection and an optimum fit in the screw head.

- T-handle screwdriver for the transmission of particularly high tightening and loosening moments
- Ergonomic 2-component handle with finger handle recesses and pleasant surface feel for very high power transmission and fatigue-free working.
- With Rapidaptor technology for lightning-fast bit changes
- Bitholders, magnetic, for easier application of the screw
- For bits with 1/4" external hexagon drive as per DIN ISO 1173-C 6.3 and E 6.3

Kraftform Kompakt 400



Code	EAN		
05057470001	4013288 214546		1
		● 416 R 1x 1/4"x45	
		⊕ 851/4 Z PH 1x PH 2x89; 1x PH 3x89	
		⊕ 855/4 Z PZ 1x PZ 2x89; 1x PZ 3x89	
		⊕ 867/4 Z TORX® 1x TX 10x89; 1x TX 15x89; 1x TX 20x89; 1x TX 25x89; 1x TX 30x89; 1x TX 40x89	
		○ 840/4 Z Hex-Plus 1x 3,0x89; 1x 4,0x89; 1x 5,0x89; 1x 6,0x89; 1x 8,0x89	
		◐ 800/4 Z 1x 1,0x5,5x89	

Kraftform Kompakt 400 RA Set 1

17-piece set in a robust textile box. One 416 RA T-handle bitholding screwdriver with ratchet function and Rapidaptor quick-release chuck for 1/4" bits. The integrated ratchet with fine toothing (80 teeth/return angle 4.5°) eases and accelerates screwdriving without having to reposition the tool. The ratchet mechanism completely embedded in the handle ensures very handy and comfortable work.

With reversing lever for comfortable clockwise/counterclockwise direction change in one-hand operation. The ergonomic shape of the handle fills the ball of the hand well, the fingers lie securely in the softly rounded recessed grips. The whole hand comes into contact with the handle, friction loss between hand and handle is avoided.

Bit holder for bits with 1/4" external hexagon drive as per DIN ISO 1173-C 6.3 and E 6.3. With Rapidaptor technology for lightning-fast bit changes. 16 tough bits, 1/4", 89 mm long, for universal use.

- The integrated ratchet with fine toothing ensures fast and safe working
- Convenient working thanks to the ratchet mechanism fully embedded in the handle
- Rapidaptor bitholding screwdriver with fast-rotating sleeve for lightning-fast bit changes and high working speeds
- Fast-rotating sleeve for extremely high working speed
- Ergonomic 2-component handle with finger handle recesses and pleasant surface feel for very high power transmission and fatigue-free working
- For bits with 1/4" external hexagon drive as per DIN ISO 1173-C 6.3 and E 6.3

Kraftform Kompakt 400 RA Set 1



Code	EAN		
05023471001	4013288 222879		1
		● 416 RA 1x 1/4"x45	
		⊕ 851/4 Z 1x PH 2x89; 1x PH 3x89	
		⊕ 855/4 Z 1x PZ 2x89; 1x PZ 3x89	
		⊕ 867/4 Z TORX® 1x TX 10x89; 1x TX 15x89; 1x TX 20x89; 1x TX 25x89; 1x TX 30x89; 1x TX 40x89	
		○ 840/4 Z 1x 3,0x89; 1x 4,0x89; 1x 5,0x89; 1x 6,0x89; 1x 8,0x89	
		◐ 800/4 Z 1x 1,0x5,5x89	
		Hook and Loop Fastener Strip 120 1x 50,0x120,0	

Kraftform Kompakt 400 RA Imperial Set 1



Code	EAN		
05057473001	4013288 222930		1
		416 RA 1x 1/4"x45	
		851/4 Z 1x PH 2x89; 1x PH 3x89	
		867/4 Z TORX® 1x TX 10x89; 1x TX 15x89; 1x TX 20x89; 1x TX 25x89; 1x TX 30x89; 1x TX 40x89	
		840/4 Z 1x 1/8"x89; 1x 5/32"x89; 1x 3/16"x89; 1x 7/32"x89; 1x 1/4"x89	
		868/4 1x # 2x89; 1x # 3x89	
		800/4 Z 1x 1,0x5,5x89	
		Hook and Loop Fastener Strip 120 1x 50,0x120,0	

Kraftform Kompakt 400 RA Set 2

9-piece set in a robust textile box. One 411 A RA T-handle adapter screwdriver with ratchet function for 1/4" sockets.

The integrated ratchet with fine toothing (80 teeth/return angle 4.5°) eases and accelerates screwdriving without having to reposition the tool. The ratchet mechanism completely embedded in the handle ensures very handy and comfortable work.

With reversing lever for comfortable clockwise/counterclockwise direction change in one-hand operation. The ergonomic shape of the handle fills the ball of the hand well, the fingers lie securely in the softly rounded recessed grips.

The whole hand comes into contact with the handle, friction loss between hand and handle is avoided. For 1/4" sockets as well as 1/4" connectors with square head drive, with ball lock. 8 Zyklop sockets with 1/4" drive.

Take it easy tool finder: With colour coding by size – for quick and easy identification of the required tool .

- Ergonomic 2-component handle with finger handle recesses and pleasant surface feel for very high power transmission and fatigue-free working
- The integrated ratchet with fine toothing ensures fast and safe working
- Reversing lever for comfortable clockwise/counterclockwise direction change
- Convenient working thanks to the ratchet mechanism fully embedded in the handle
- Fast-rotating sleeve for extremely high working speed
- 1/4" socket mounting with secure ball lock
- With Take it easy tool finder: colour coding by size

Kraftform Kompakt 400 RA Set 2

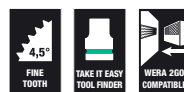

Code	EAN		
05023470001	4013288 222862		1
		411 A RA 1x 1/4"x45	
		8790 HMA 1x 6,0x23,0; 1x 7,0x23,0; 1x 8,0x23,0; 1x 9,0x23,0; 1x 10,0x23,0; 1x 11,0x23,0; 1x 12,0x23,0; 1x 13,0x23,0	
		Hook and Loop Fastener Strip 120 1x 50,0x120,0	

Kraftform Kompakt 400 RA Imperial Set 2



Code	EAN			
05057474001	4013288 223364			1
		□	411 A RA 1x 1/4"x45	
		●	8790 HMA 1x 3/16"x23,0; 1x 7/32"x23,0; 1x 1/4"x23,0; 1x 9/32"x23,0; 1x 5/16"x23,0; 1x 3/8"x23,0; 1x 7/16"x23,0; 1x 1/2"x23,0	
			Hook and Loop Fastener Strip 120 1x 50,0x120,0	

Kraftform Kompakt 900 Set 1

The impact screwdriver 921 combines the advantages of manual impact wrenches, compact tools and screwdrivers with pound-thru blade. The impact wrench function offers a loosening moment of up to 25 Nm.

The robust bit holder allows the mounting of different specialised bits for various screw profiles. The pound-thru blade ensures complete power transmission (zero loss). The impact wrench function and screwdriver function can be switched as required.

- Compact and robust blade screwdriver set with manually activatable impact wrench function
- For loosening stubborn screw connections
- Hammer blow impulse is converted into a rotary movement with a loosening torque of approx. 25 Nm – without loss via a pound-thru blade
- Reversible functions: impact wrench and screwdriver
- Specially hardened and extra tough bits with 1/4" external hexagon drive
- Combines the advantages of manual impact wrenches, compact tools and screwdrivers with pound-thru blade

Kraftform Kompakt 900 Set 1



Code	EAN			
05018110001	4013288 222176			1
		●	921 1x 1/4"x163,5	
		+	851 S 1x PH 1x70; 1x PH 2x70; 1x PH 3x70	
		+	855 S 1x PZ 1x70; 1x PZ 2x70; 1x PZ 3x70	
		*	867 S TORX® 1x TX 15x70; 1x TX 20x70; 1x TX 25x70; 1x TX 30x70; 1x TX 40x70	
		⊕	840 S Hex-Plus 1x 3,0x70; 1x 4,0x70; 1x 5,0x70; 1x 6,0x70	
		●	800 S 1x 0,8x4,0x70; 1x 1,0x5,5x70; 1x 1,2x6,5x70	
			Hook and Loop Fastener Strip 120 1x 50,0x120,0	



Kraftform Kompakt 900 Imperial Set 1



Code	EAN							
0501811001	222312							1
			921 1x 1/4"x163,5					
			851 S 1x PH 1x70; 1x PH 2x70; 1x PH 3x70					
			867 S TORX® 1x TX 15x70; 1x TX 20x70; 1x TX 25x70; 1x TX 30x70; 1x TX 40x70					
			840 S Hex-Plus 1x 1/8"x70; 1x 5/32"x70; 1x 3/16"x70; 1x 1/4"x70					
			868 S 1x # 1x70; 1x # 2x70; 1x # 3x70					
			800 S 1x 0,8x4,0x70; 1x 1,0x5,5x70; 1x 1,2x6,5x70					
			Hook and Loop Fastener Strip 120 1x 50,0x120,0					

921 Kraftform Plus impact screwdriver - series 900

The impact screwdriver 921 combines the advantages of manual impact wrenches, compact tools and screwdrivers with pound-thru blade. The impact wrench function offers a loosening moment of up to 25 Nm.

The robust bit holder allows the mounting of different specialised bits for various screw profiles. The pound-thru blade ensures complete power transmission (zero loss). The impact wrench function and screwdriver function can be switched as required.

- For loosening stubborn screw connections
- Manual impact wrench function can be switched on and off
- Hammer blow impulse is converted into a rotary movement with a loosening torque of approx. 25 Nm – without loss via a pound-thru blade
- Reversible functions: impact wrench and screwdriver

921 Kraftform Plus impact screwdriver - series 900



Code	EAN								
0501810001	221698	1/4"	163,5	6 7/16"					1

851 S Phillips bits for impact screwdrivers

Extra tough bit for Phillips-head screws Phillips-Recess. This prevents the bit from breaking prematurely and extends its service life.

Suitable for use with Wera impact screwdriver 921. With 1/4" hexagonal drive.

- For Phillips screws
- Extra tough for long durability
- 1/4" hexagon drive
- For use with Wera impact screwdriver 921

851 S Phillips bits for impact screwdrivers



Code	EAN								
05018160001	222510	PH 1	70	2 3/4"					5
05018161001	222527	PH 2	70	2 3/4"					5
05018162001	222534	PH 3	70	2 3/4"					5

855 S Pozidriv bits for impact screwdrivers

Extra tough bit suitable for Pozidriv screws. This prevents the bit from breaking prematurely and extends its service life.

Suitable for use with Wera impact screwdriver 921. With 1/4" hexagonal drive.

- Suitable for Pozidriv screws
- Extra tough for long durability
- 1/4" hexagon drive
- For use with Wera impact screwdriver 921

855 S Pozidriv bits for impact screwdrivers



	EAN					
Code	4013288		mm			
05018163001	222541	PZ 1	70	2 3/4"		5
05018164001	222558	PZ 2	70	2 3/4"		5
05018165001	222565	PZ 3	70	2 3/4"		5

867 S TORX® bits for impact screwdrivers

Extra tough bit for TORX® socket screws. This prevents the bit from breaking prematurely and extends its service life.

Suitable for use with Wera impact screwdriver 921. With 1/4" hexagonal drive.

- For recessed TORX® screws
- Extra tough for long durability
- 1/4" hexagon drive
- For use with Wera impact screwdriver 921

867 S TORX® bits for impact screwdrivers



	EAN					
Code	4013288		mm			
05018166001	222572	TX 15	70	2 3/4"		5
05018167001	222589	TX 20	70	2 3/4"		5
05018168001	222596	TX 25	70	2 3/4"		5
05018169001	222602	TX 30	70	2 3/4"		5
05018170001	222619	TX 40	70	2 3/4"		5

Hex-Plus - lets hexagon socket screws last longer

Deformation of the screws is reduced

Above-average service life

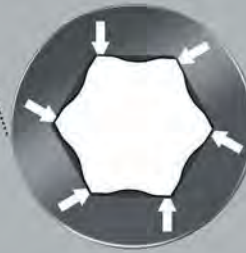

Extra tough bit for hexagonal socket screws. This prevents the bit from breaking prematurely and extends its service life.

Suitable for use with Wera impact screwdrivers 921. With 1/4" hexagonal drive.

- For socket head screws
- Extra tough for long durability
- Hex-Plus allows socket head screws to live longer
- 1/4" hexagon drive
- For use with Wera impact screwdriver 921

840 S Hex-Plus bits for impact screwdrivers



	EAN					
Code	4013288		mm			
05018150001	222428	3,0	70	2 3/4"		5
05018151001	222435	4,0	70	2 3/4"		5
05018152001	222442	5,0	70	2 3/4"		5
05018153001	222459	6,0	70	2 3/4"		5
05018154001	222466	1/8"	70	2 3/4"		5
05018155001	222473	5/32"	70	2 3/4"		5
05018156001	222480	3/16"	70	2 3/4"		5
05018157001	222497	1/4"	70	2 3/4"		5



800 S Slotted bits for impact screwdrivers

Extra tough bit for slotted screws. This prevents the bit from breaking prematurely and extends its service life.

Suitable for use with Wera impact screwdriver 921. With 1/4" hexagonal drive.

- For slotted screws
- Extra tough for long durability
- 1/4" hexagon drive
- For use with Wera impact screwdriver 921

800 S Slotted bits for impact screwdrivers



	EAN						
Code	4013288	mm	mm	mm			
05018140001	222398	0,8	4,0	70	2 3/4"		5
05018141001	222404	1,0	5,5	70	2 3/4"		5
05018142001	222411	1,2	6,5	70	2 3/4"		5

868 S Square head socket bits for impact screwdrivers

Extra tough bit for square head socket screws. This prevents the bit from breaking prematurely and extends its service life.

Suitable for use with Wera impact screwdriver 921. With 1/4" hexagonal drive.

- Suitable for square head socket screws
- Extra tough for long durability
- 1/4" hexagon drive
- For use with Wera impact screwdriver 921

868 S Square head socket bits for impact screwdrivers



	EAN						
Code	4013288		mm				
05018171001	222626	# 1	70	2 3/4"			5
05018172001	222633	# 2	70	2 3/4"			5
05018173001	222640	# 3	70	2 3/4"			5

Kraftform Kompakt Stubby magazine RA 1

Particularly small bitholding screwdriver with extremely short bit mounting for hard to reach areas. With ratchet function and fine toothing for a low return angle.

Easy-to-operate reversible ring (right, fixed, left). Includes 6 tough, universal bits, which are located in a magazine in the handle. The strong permanent magnet in the bit mounting ensures secure holding of the bit.

The 2-component Kraftform handle with the practical combination of hard and soft zones allows for a firm grip and precise working.

Take it easy tool finder: With size stamping and colour coding by output to help you find the required bit easily.

- Short, compact Stubby shape for working in tight installation spaces, with 6 bits in the integrated magazine
- Ergonomic 2-component Kraftform handle for precise work
- Ratchet function with fine toothing for a low return angle and reversible ring (right, fixed, left)
- Captive and swiveling bit magazine for easy removal and safe storage of bits
- Take it easy tool finder: colour coding according to profile and size

Kraftform Kompakt Stubby magazine RA 1

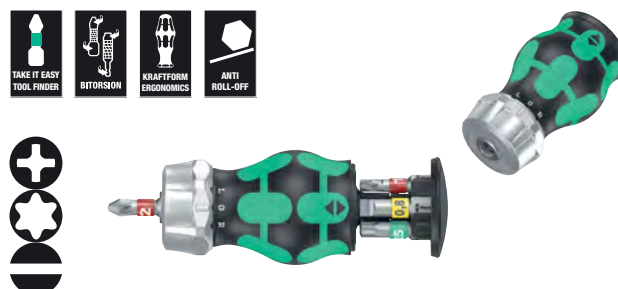

Code	EAN		
05008883001	4013288 221124		1
		851/1 BTZ PH 1x PH 1x25; 1x PH 2x25	
		867/1 TORX® BTZ 1x TX 15x25; 1x TX 20x25; 1x TX 25x25	
		800/1 BTZ 1x 0,8x5,5x25	

Kraftform Kompakt Stubby magazine RA 2



Code	EAN		
05008884001	4013288 221131		1
		⊕ 851/1 BTZ PH 1x PH 1x25; 1x PH 2x25	
		⊕ 855/1 BTZ PZ 1x PZ 1x25; 1x PZ 2x25	
		⊗ 867/1 TORX® BTZ 1x TX 25x25	
		⊖ 800/1 BTZ 1x 0,8x5,5x25	

Kraftform Kompakt Stubby magazine RA 3

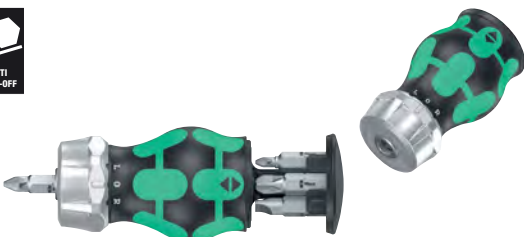

Code	EAN		
05008885001	4013288 221148		1
		⊕ 851/1 Z PH 1x PH 1x25; 1x PH 2x25; 1x PH 3x25	
		⊖ 800/1 Z 1x 0,6x4,5x25; 1x 1,0x5,5x25; 1x 1,2x6,5x25	

Kraftform Kompakt Stubby magazine RA 4

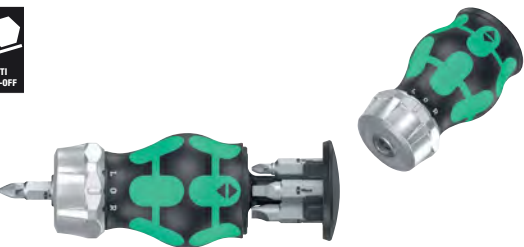

Code	EAN		
05008886001	4013288 221155		1
		⊕ 851/1 Z PH 1x PH 1x25; 1x PH 2x25	
		□ 868/1 Z 1x # 1x25; 1x # 2x25	
		⊖ 800/1 Z 1x 1,0x5,5x25; 1x 1,2x6,5x25	

Kraftform Kompakt Stubby magazine

Particularly small bitholding screwdriver with short bit mounting for hard to reach areas. Includes 6 bits, which are located in a magazine in the handle.

With only 65mm total length, the Kraftform Kompakt Stubby is a real mini screwdriving workshop. The strong permanent magnet in the bit mounting ensures secure holding of the bit.

The 2-component handle with the practical combination of hard and soft zones allows for a firm grip and precise working. Take it easy tool finder: With size stamping and colour coding by output to find the required bit easily.

- Short, compact Stubby shape for working in tight installation spaces, with 6 bits in the integrated magazine
- Ergonomic 2-component Kraftform handle for precise work
- 1/4" bit mounting with strong permanent magnet
- Captive and swiveling bit magazine for easy removal and safe storage of bits
- Take it easy tool finder: colour coding according to profile and size

Kraftform Kompakt Stubby magazine 1



Code	EAN		
05008873001	4013288 217769		1
		⊕ 851/1 BTZ PH 1x PH 1x25; 1x PH 2x25	
		⊗ 867/1 TORX® BTZ 1x TX 15x25; 1x TX 20x25; 1x TX 25x25	
		⊖ 800/1 BTZ 1x 0,8x5,5x25	

Kraftform Kompakt Stubby magazine 2



Code	EAN		
05008874001	4013288 217776		1
		⊖ 800/1 BTZ 1x 0,8x5,5x25; 1x 1,2x6,5x25	
		⊕ 851/1 BTZ PH 1x PH 1x25; 1x PH 2x25	
		⊕ 855/1 BTZ PZ 1x PZ 1x25; 1x PZ 2x25	

Kraftform Kompakt Stubby magazine 3



	Code	EAN		
	05008875001	4013288		
		217783		1
			867/1 TORX® BTZ	
			1x TX 15x25; 1x TX 20x25; 1x TX 25x25	

Kraftform Kompakt Stubby magazine 4



	Code	EAN		
	05008877001	4013288		
		219800		1
			851/1 Z PH	
			1x PH 1x25; 1x PH 2x25; 1x PH 3x25	
			800/1 Z	
			1x 0,6x4,5x25; 1x 1,0x5,5x25; 1x 1,2x6,5x25	

Kraftform Kompakt Stubby magazine 5



	Code	EAN		
	05008878001	4013288		
		219817		1
			800/1 Z	
			1x 1,0x5,5x25; 1x 1,2x6,5x25	
			851/1 Z PH	
			1x PH 1x25; 1x PH 2x25	
			868/1 Z	
			1x # 1x25; 1x # 2x25	

Kraftform Kompakt Stubby 1

Handle/interchangeable blade system for lightning fast replacement of the required blade. Especially small bit-holding Stubby screwdriver handle with short blade for hard to reach areas.

Suitable for the mounting of bits with 1/4" hexagon drive as per DIN ISO 1173-C 6.3 and Wera connection series 1. With strong permanent magnet, which also holds large and heavy screws.

The 2-component Kraftform handle with its practical combination of hard and soft zones allows for a firm grip and precise working. High-quality BiTorsion bits with a softer BiTorsion zone to prevent twisting of the bit tip under high loads. This significantly increases product life.

Compact, textile box with high robustness, low weight and volume. Suitable for docking with the Wera 2go system.

- Handle/interchangeable blade system for rapid exchange of the blade
- Stubby bit hand holder: short compact shape for working in confined spaces
- Ergonomic 2-component Kraftform handle for precise work
- Bits with BiTorsion zone to cushion load peaks
- Take it easy tool finder: colour coding according to profile and size

Kraftform Kompakt Stubby 1



	Code	EAN		
	05057471001	4013288		
		214553		1
			811/1 Stubby	
			1x 1/4"	
			851/1 BTZ PH	
			1x PH 1x25; 1x PH 2x25	
			855/1 BTZ PZ	
			1x PZ 1x25; 1x PZ 2x25	
			867/1 TORX® BTZ	
			1x TX 10x25; 1x TX 15x25; 1x TX 20x25;	
			1x TX 25x25; 1x TX 30x25	
			840/1 BTZ Hex-Plus	
			1x 2,0x25; 1x 2,5x25; 1x 3,0x25; 1x 4,0x25;	
			1x 5,0x25; 1x 5,5x25	
			800/1 BTZ	
			1x 0,8x5,5x25; 1x 1,0x5,5x25; 1x 1,2x6,5x25	

Bicycle set 11

Stubby magazine for quick operations on the bike. Particularly small bit hand-holder with short bit mounting for hard to reach areas. Includes 7 stainless steel bits, 6 of which are located in a magazine in the handle and one in the bit holder.

The 2-component Kraftform handle with the practical combination of hard and soft zones allows for a firm grip and precise working.

Take it easy tool finder: With size stamping and colour coding by output to help you find the required bit easily.

- Short compact Stubby shape for working in tight installation spaces with 7 included bits
- Ergonomic 2-component Kraftform handle for precise work
- Stainless Steel Bits
- Captive and swiveling bit magazine for easy removal and safe storage of bits
- Take it easy tool finder: colour coding according to profile and size

Bicycle set 11



Code	EAN			
05004179001	4013288 220714			1
		+	3851/1 TS PH 1x PH 1x25	
		*	3867/1 TS TORX® 1x TX 10x25; 1x TX 25x25	
		○	3840/1 TS 1x 2,5x25; 1x 3,0x25; 1x 4,0x25; 1x 5,0x25	

Bicycle set 5

Particularly small bitholding screwdriver with extremely short bit mounting for hard to reach areas. With ratchet function and fine toothing for a low return angle.

Easy-to-operate reversible ring (right, tight, left). Includes 7 stainless steel bits, 6 of which are located in a magazine in the handle and one in the bit holder. The strong permanent magnet in the bit mounting ensures secure holding of the bit.

The 2-component Kraftform handle with the practical combination of hard and soft zones allows for a firm grip and precise working.

Take it easy tool finder: With size stamping and colour coding by output to help you find the required bit easily.

- Short compact Stubby shape with magazine for working in tight installation spaces, including 7 stainless steel bits
- Ergonomic 2-component Kraftform handle for precise work
- Ratchet function with fine toothing for a low return angle and reversible ring (right, tight, left)
- Captive and swiveling bit magazine for easy removal and safe storage of bits
- Take it easy tool finder: colour coding according to profile and size

Bicycle set 5



Code	EAN			
05004185001	4013288 221162			1
		+	3851/1 TS PH 1x PH 1x25	
		*	3867/1 TS TORX® 1x TX 10x25; 1x TX 25x25	
		○	3840/1 TS 1x 2,5x25; 1x 3,0x25; 1x 4,0x25; 1x 5,0x25	



Kraftform Kompakt W 1 Maintenance

Compact tool set with the 35 most important screwdriving tools for maintenance work both indoors as well as outdoors.

Includes VDE holder with 12 VDE blades; 1 Joker double open-end wrench with holding function, limit stop, small return angle and extremely gripping teeth; the incredibly fast 1/4" Zyklop Speed ratchet and accessories; 8 manual and power tool sockets, sizes 5.5-13,

1 universal bit holder; 7 bits in a length of 25 mm; 1 screw gripper for firmly holding screws; 1 single-pole phase tester 247; textile box, very robust and durable; can be positioned upright in the workshop shelf for convenient storage; additional surface protection thanks to the textile outer material; low weight and volume for simplified mobility.

- Incredibly fast 1/4" Zyklop Speed ratchet with pivoting ratchet head and 5 predefined locking positions
- Manual and power tool sockets (non-impact) with ball-stop groove and knurling at lower end for more grip
- Joker double open-end wrench with holding function, limit stop, small return angle and extremely gripping teeth
- VDE-insulated Kraftform holder and interchangeable blades
- Set in robust textile box

Kraftform Kompakt W 1 Maintenance



Code	EAN		
05135926001	4013288 178336		1
		817 VDE 1x 9x102	
		KK 60 i 1x 0,4x2,5x154	
		KK 60 iS 1x 0,6x3,5x154; 1x 0,8x4,0x154; 1x 1,0x5,5x154	
		KK 62 iS 1x PH 1x154; 1x PH 2x154	
		KK 65 iS PZ 1x PZ 1x154; 1x PZ 2x154	
		KK 67 i TORX® 1x TX 10x154	
		KK 67 iS TORX® 1x TX 15x154; 1x TX 20x154; 1x TX 25x154	
		1440 1x 4,5 - 6,0x41,0	
		247 1x 0,5x3,0x70	
		6002 Joker Double 1x 10x13x167	
		8000 A 1x 1/4"x152,0	
		8784 A1 1x 1/4"x1/4"x37,0	
		8794 SA 1x 1/4"x75,0	
		8790 HMA 1x 5,5x23,0; 1x 6,0x23,0; 1x 7,0x23,0; 1x 8,0x23,0; 1x 10,0x23,0; 1x 11,0x23,0; 1x 12,0x23,0; 1x 13,0x23,0	
		893/4/1 K 1x 1/4"x50	
		855/1 Z PZ 1x PZ 1x25; 1x PZ 2x25	
		840/1 Z Hex-Plus 1x 3,0x25; 1x 4,0x25; 1x 5,0x25; 1x 6,0x25	
		867/1 TORX® 1x TX 25x25	

*Product not available in the USA and Canada.

Kraftform Kompakt W 2 Maintenance



Code	EAN			
05135870001	4013288 209542			1
		●	817 VDE 1x 9x102	
		●	KK 60 i 1x 0,4x2,5x154	
		●	KK 60 iS 1x 0,6x3,5x154; 1x 0,8x4,0x154; 1x 1,0x5,5x154	
		+	KK 62 iS 1x PH 1x154; 1x PH 2x154	
		+	KK 67 i TORX® 1x TX 10x154	
		+	KK 67 iS TORX® 1x TX 15x154; 1x TX 20x154; 1x TX 25x154	
		+	KK 65 iS PZ 1x PZ 1x154; 1x PZ 2x154	
			1440 1x 4,5 - 6,0x41,0	
		●	335 1x 0,4x2,5x60 ¹⁾	
			6002 Joker Double 1x 10x13x167	
		□	8000 A 1x 1/4"x152,0	
		●	8784 A1 1x 1/4"x1/4"x37,0	
		●	8794 SA 1x 1/4"x75,0	
		●	8790 HMA 1x 5,5x23,0; 1x 6,0x23,0; 1x 7,0x23,0; 1x 8,0x23,0; 1x 10,0x23,0; 1x 11,0x23,0; 1x 12,0x23,0; 1x 13,0x23,0	
		●	893/4/1 K 1x 1/4"x50	
		+	851/1 Z PH 1x PH 1x25; 1x PH 2x25	
		○	840/1 Z Hex-Plus 1x 3,0x25; 1x 4,0x25; 1x 5,0x25; 1x 6,0x25	
		+	867/1 TORX® 1x TX 25x25	

¹⁾without Lasertip

Kraftform Kompakt W Imperial 1 Maintenance



Code	EAN			
05135871001	4013288 209559			1
		●	817 VDE 1x 9x102	
		●	KK 60 i 1x 0,4x2,5x154	
		●	KK 60 iS 1x 0,6x3,5x154; 1x 0,8x4,0x154; 1x 1,0x5,5x154	
		+	KK 62 iS 1x PH 1x154; 1x PH 2x154	
		+	KK 67 i TORX® 1x TX 10x154	
		+	KK 67 iS TORX® 1x TX 15x154; 1x TX 20x154; 1x TX 25x154	
		○	KK 68 iS 1x # 1x154; 1x # 2x154	
		●	335 1x 0,4x2,5x60 ¹⁾	
			1440 1x 4,5 - 6,0x41,0	
			6000 Joker Imperial 1x 1/2"x177	
		□	8000 A 1x 1/4"x152,0	
		●	8790 HMA 1x 7/32"x23,0; 1x 1/4"x23,0; 1x 9/32"x23,0; 1x 5/16"x23,0; 1x 3/8"x23,0; 1x 7/16"x23,0; 1x 1/2"x23,0; 1x 9/16"x23,0	
		●	8784 A1 1x 1/4"x1/4"x37,0	
		●	8794 SA 1x 1/4"x75,0	
		●	893/4/1 K 1x 1/4"x50	
		+	851/1 Z PH 1x PH 1x25; 1x PH 2x25	
		○	840/1 Z Hex-Plus 1x 1/8"x25; 1x 9/32"x25; 1x 7/32"x25; 1x 1/4"x25	
		+	867/1 TORX® 1x TX 25x25	

¹⁾without Lasertip



Kraftform Kompakt H 1 Woodcraft

Compact tool set with the 41 most important screwdriving tools for applications involving wood. Includes the bit ratchet Zyklop Mini with extension and socket adaptor; 8 manual and power tool sockets, sizes 5.5-13, 1 ratchet holder 816 RA with ratcheting function, fine-pitched teeth for small return angle, switchover ring (right, fixed, left), maximum torque 50 Nm and bit take-up with the Rapidaptor technology; 1 universal bit holder; 6 bits in a length of 25 mm; 16 bits of a length of 89 mm; 5 wood twist drill bits with a diameter of 3-8 mm; 1 screw gripper for firmly holding screws; 1 single-pole phase tester 247; textile box, very robust and durable; can be positioned upright in the workshop shelf for convenient storage; additional surface protection thanks to the textile outer material; low weight and volume for simplified mobility.

- Robust Zyklop Mini ratchet suitable for take-up of bits and sockets
- Torque of over 65 Nm thanks to fine-pitched ratchet mechanism and small return angle of 6°
- Ratcheting screwdriver with Rapidaptor technology for rapid bit change
- High quality wood twist drill bits for drilling soft wood, hard wood and laminated panel material
- Set in robust textile box

Kraftform Kompakt H 1 Woodcraft



Code	EAN		
	4013288		
05135939001	178350		1
		816 RA 1x 1/4"x142,0	
		8001 A 1x 1/4"x87,0	
		870/1 1x 1/4"x25 ¹⁾	
		8794 SA 1x 1/4"x75,0	
		8790 HMA 1x 5,5x23,0; 1x 6,0x23,0; 1x 7,0x23,0; 1x 8,0x23,0; 1x 10,0x23,0; 1x 12,0x23,0; 1x 13,0x23,0	
		893/4/1 K 1x 1/4"x50	
		851/4 Z PH 1x PH 1x89; 1x PH 2x89; 1x PH 3x89	
		855/4 Z PZ 1x PZ 1x89; 1x PZ 2x89; 1x PZ 3x89	
		855/1 Z PZ 1x PZ 1x25; 1x PZ 2x25; 1x PZ 3x25	
		867/4 Z TORX® BO 1x TX 10x89; 1x TX 15x89; 1x TX 20x89; 1x TX 25x89; 1x TX 30x89	
		867/1 TORX® 1x TX 20x25; 1x TX 25x25	
		840/4 Z Hex-Plus 1x 3,0x89; 1x 4,0x89; 1x 5,0x89; 1x 6,0x89	
		800/4 Z 1x 1,0x5,5x89	
		800/1 Z 1x 1,0x5,5x25	
		849 HSS 1x 3,0x70,0; 1x 4,0x74,0; 1x 5,0x85,0; 1x 6,0x95,0; 1x 8,0x110,0	
		247 1x 0,5x3,0x70	
		1441 1x 4,5 - 6,0x41,0	

¹⁾ With friction ball; for manual nut spinner sockets

²⁾ Product not available in the USA and Canada.

Kraftform Kompakt M 1 Metal

Compact tool set with the 39 most important screwdriving tools for jobs on metal. Includes the incredibly fast 1/4" Zyklop Speed ratchet and accessories; 7 manual and power tool sockets, sizes 5.5-13, 1 universal bit holder;

13 bits in a length of 89 mm; 6 metal twist drill bits with diameter of 3-10 mm; 1 screw gripper for firmly holding screws; 1 single-pole phase tester 247; textile box, very robust and durable; can be positioned upright in the workshop shelf for convenient storage; additional surface protection thanks to the textile outer material; low weight and volume for simplified mobility.

Kraftform Kompakt M 1 Metal



Code	EAN			
05135928001	4013288 178367			1
		8000 A	1x 1/4"x152,0	
		8794 LA	1x 1/4"x150,0	
		8794 A	1x 1/4"x56,0	
		8784 A1	1x 1/4"x1/4"x37,0	
		816 R	1x 1/4"x119	
		8790 HMA	1x 5,5x23,0; 1x 6,0x23,0; 1x 7,0x23,0; 1x 8,0x23,0; 1x 10,0x23,0; 1x 12,0x23,0; 1x 13,0x23,0	
		851/4 Z PH	1x PH 1x89; 1x PH 2x89; 1x PH 3x89	
		840/4 Z Hex-Plus	1x 3,0x89; 1x 4,0x89; 1x 5,0x89; 1x 6,0x89	
		867/4 Z TORX®	1x TX 10x89; 1x TX 15x89; 1x TX 20x89; 1x TX 25x89; 1x TX 30x89	
		800/4 Z	1x 1,0x5,5x89	
		847 HSS	1x 2,5x36,0; 1x 3,3x39,0; 1x 4,2x41,0; 1x 5,0x44,0; 1x 6,8x51,0; 1x 8,5x59,0	
		848 HSS	1x 3,0x38,0; 1x 4,0x44,0; 1x 5,0x50,0; 1x 6,0x50,0; 1x 8,0x51,0; 1x 10,0x54,0	
		1441	1x 4,5 - 6,0x41,0	
		247	1x 0,5x3,0x70	

*)Product not available in the USA and Canada.

Kraftform Kompakt SH 1 PlumbKit

Compact tool set with the 25 most important screwdriving tools for plumbing and heating applications. Includes 2 Joker open-end wrenches, the 1/4" Zyklop ratchet and accessories, 6 x 89 mm bits, 5 multi-component Kraftform Plus screwdrivers and single-pole phase tester. Two Joker combination ratcheting wrenches with special holding plate against slipping/loss of the screw and more torque transfer; 1 Zyklop ratchet 8000 A (1/4") for fast, powerful working; 3 Zyklop sockets 8790 HMA for manual and power tools usage; 1 Zyklop adaptor 8784 A1 for bits; 6 TORX® HF bits 867/4 with holding function for TORX® screws for secure carry without any loss of the screws;

1 single-pole phase tester 247; 2 Kraftform series 100 slotted screwdrivers 160 i and 160 iS for safe work up to 1,000 volts (160 iS with reduced shaft diameter and integrated insulation protection for reaching and actuating low-lying screws and spring elements);

1 Kraftform Chiseldriver 932 A (slotted) with hex blade extending right through the handle and integrated impact cap for screwdriving and simpler chiselling work; 2 nutsetters 395 HO with hollow shaft for the tightening or loosening of screws on long bolts as well as seized screws.

Take it easy tool finder with colour coding according to profiles and size stamp – for simple and rapid accessing of the required tool.

- Joker combination ratcheting wrench with special holding plate against slipping/loss of the screw
- Zyklop Speed ratchet for fast and powerful working
- Insulated Kraftform VDE slotted screwdriver for safe work at 1,000 volts
- Kraftform Chiseldriver with hex blade extending through handle and integrated impact cap
- Hollow shaft nutspinner for nuts on protruding threaded rods



Kraftform Kompakt SH 1 PlumbKit



Code	EAN		
05135927001	170132		1
		6000 Joker 1x 10x159; 1x 13x177	
		8000 A 1x 1/4"x152,0	
		8790 HMA 1x 7,0x23,0; 1x 10,0x23,0; 1x 13,0x23,0	
		8784 A1 1x 1/4"x1/4"x37,0	
		867/4 TORX® HF 1x TX 10x50; 1x TX 15x50; 1x TX 20x50; 1x TX 25x50; 1x TX 30x50; 1x TX 40x50 ¹⁾	
		851/4 Z PH 1x PH 1x89; 1x PH 2x89	
		840/4 Z Hex-Plus 1x 3,0x89; 1x 4,0x89; 1x 5,0x89; 1x 6,0x89	
		247 1x 0,5x3,0x70	
		160 iS 1x 0,6x3,5x100	
		160 i VDE 1x 1,0x5,5x125	
		932 A 1x 1,2x7,0x125	
		395 HO 1x 10,0x90; 1x 13,0x90	

¹⁾ Product not available in the USA and Canada.

¹⁾ Pound-thru hexagonal; no Take it easy.

Kraftform Kompakt SH 2 PlumbKit

- 15 screwdriving tools for sanitary or heating applications in compact and robust Wera textile box
- Joker combination ratcheting wrench with special holding plate against slipping/loss of the screw
- Insulated Kraftform VDE slotted screwdriver for safe work at 1,000 volts
- Kraftform Chiseldriver with hex blade extending through handle and integrated impact cap
- Hollow shaft nutspinner for nuts on protruding threaded rods

Kraftform Kompakt SH 2 PlumbKit



Code	EAN		
05136026001	204387		1
		395 HO 1x 10,0x90; 1x 13,0x90	
		932 A 1x 1,2x7,0x125	
		6001 Joker Switch 1x 10x159; 1x 13x179	
		950 SPKL HF Multicolour 1x 3,0x123; 1x 4,0x137; 1x 5,0x154; 1x 6,0x172	
		817 VDE 1x 9x102	
		KK 62 iS 1x PH 1x154; 1x PH 2x154	
		KK 60 iS 1x 0,6x3,5x154; 1x 1,0x5,5x154	
		247 1x 0,5x3,0x70	
		K240 1x 50,0x240,0	

¹⁾ Product not available in the USA and Canada.

Kraftform Kompakt F 1 screwdriving tool set for window installation

Compact Wera screwdriving tool set with the 36 most important tools for window construction

- Premium 36-piece universal tool set for the professional window builder
- 393 S extra slim bit hand holder with flexible shaft for applications in hard-to-reach work spaces
- Socket wrench and bit assortment in premium Wera quality, attuned to universal window construction applications
- Compact and solid textile tool box with Wera 2go compatibility

Kraftform Kompakt F 1 screwdriving tool set for window installation



Code	EAN		
05134013001	4013288 217721		1
		● 393 S 1x 1/4"x173,5	
		● 813 1x 1/4"x78	
		□ 8001 A 1x 1/4"x87,0	
		○ 870/1 1x 1/4"x25 ¹⁾	
		■ 8794 SA 1x 1/4"x75,0	
		● 8790 HMA 1x 7,0x23,0; 1x 8,0x23,0; 1x 10,0x23,0; 1x 13,0x23,0	
		+ 851/4 TZ PH 1x PH 1x50; 1x PH 2x50; 1x PH 3x50	
		★ 867/4 Z TORX® 1x TX 8x50; 1x TX 10x50; 1x TX 15x50; 1x TX 20x50; 1x TX 25x50; 1x TX 30x50	
		○ 840/4 Z Hex-Plus 1x 2,0x50; 1x 2,5x50; 1x 3,0x50; 1x 4,0x50; 1x 5,0x50; 1x 6,0x89	
		○ 950 SPKL Multicolour 1x 2,0x101; 1x 2,5x112	
		○ 950 SPKL HF Multicolour 1x 3,0x123; 1x 4,0x137; 1x 5,0x154	
		★ 967 SXL TORX® HF Multicolour 1x TX 8x90; 1x TX 10x112; 1x TX 15x123; 1x TX 20x137; 1x TX 25x154; 1x TX 30x195	
		● 6004 Joker S 1x 10-13x7/16"-1/2"x154	

¹⁾With friction ball; for manual nut spinner sockets

9100 guitar tool set

Guitar tool set: The set contains all the tools necessary for adjustment and maintenance repair work. Wera stainless steel angle wrench with Hex-Plus profile (sizes: 1.5, 2.0, 2.5, 5.0 and in the inch sizes 1/8", 5/32", 3/16").

Wera 89 mm long stainless steel bits for hexagon socket screws (sizes: 1.5, 2.0, 2.5), Kraftform handle for 1/4" bits, 1/4" stainless steel bits for slot (sizes: 1.8x 12x41 mm, 0.6x3.5x89 mm, 1.2x8.0x89 mm), Phillips screws (sizes: PH 1x89 mm, PH 2x89 mm) and hexagon socket screws (size: 0.05"x25 mm), Wera adapter for handle (1/4" hex socket of the handle on 1/4" square of sockets), Wera Zyklop sockets (sizes 10 and 1/2"), string crank with 1/4" hex for use in the handle, Knipex® string cutter, feeler gauge, input jacker, 2 picks.

9100 guitar tool set



Code	EAN		
05134015001	4013288 211675		1
		● 815 R 1x 1/4"x119	
		+ 3851/4 1x PH 1x89; 1x PH 2x89	
		● 3800/1 TS 1x 1,8x12,0x41	
		● 3800/4 1x 0,6x3,5x89; 1x 1,2x8,0x89	
		○ 3840/1 TS 1x 0,05"x25x1"	
		○ 3950 PKL 1x 1,5x90; 1x 2,0x101; 1x 2,5x112; 1x 3,0x123; 1x 4,0x137; 1x 5,0x154	
		○ 3950 PKL inch 1x 1/8"x123; 1x 5/32"x137; 1x 3/16"x154	
		○ 870/1 1x 1/4"x25 ¹⁾	
		● 8790 HMA 1x 10,0x23,0	
		● 8790 HMA Deep 1x 1/2"x50,0	
		9103	
		9105	
		9104	
		9001	
		9102	
		9110	
		KNIPEX® 74 01 140	

¹⁾With friction ball; for manual nut spinner sockets

Radidaptor - the amazing compact multifunction tool



High quality holder for stainless steel bits so as to avoid the formation of extraneous rust. The Rapidaptor quick-release chuck enables rapid bit change without needing any special tools.

Krafftform Plus handle for pleasant, ergonomic working that makes blisters and calluses a thing of the past. Hard gripping zones for high working speeds whereas soft zones ensure high torque transfer.

Suitable for bits with 1/4" hexagon head drive as per DIN ISO 1173-C 6.3 and E 6.3 (ISO 1173).

- Solution to the extraneous rust problem: fasten stainless screws with stainless tools
- Bit handholder with Rapidaptor quick-release chuck, stainless
- Secure clamping of bits
- Fast bit change
- Free-turning sleeve for guiding the power tool

Krafftform Stainless - stainless steel to prevent rust

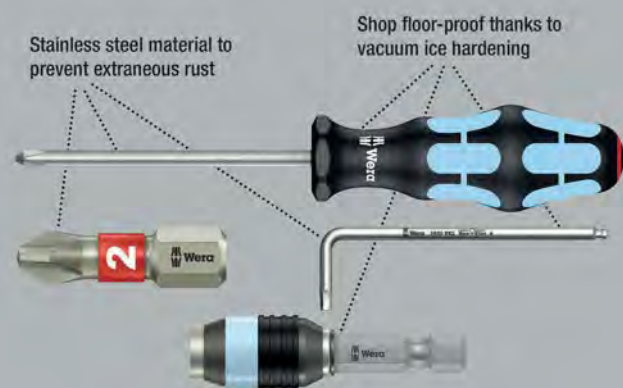

3816 R Bit-holding screwdriver with Rapidaptor quick-release chuck, stainless



	EAN							
Code	4013288		mm					
05051465001	127570	1/4"	119					5

817 R Bitholding screwdriver with Rapidaptor quick-release chuck

High quality bit holder. The telescopic bayonet blade, which can be lowered into the handle, together with the quick-release chuck allows fast manual work even in confined installation situations. The Rapidaptor quick-release chuck enables rapid bit change without needing any special tools.

The strong permanent magnet holds the bits absolutely securely. Krafftform Plus handle for pleasant, ergonomic working that makes blisters and calluses a thing of the past. Hard gripping zones for high working speeds whereas soft zones ensure high torque transfer. Suitable for bits with 1/4" hexagon head drive as per DIN ISO 1173-C 6.3 and E 6.3 (ISO 1173).

- Retractable bayonet blade

817 R Bitholding screwdriver with Rapidaptor quick-release chuck



	EAN							
Code	4013288		mm					
05051482001	103130	1/4"	133					2

817 R SB Bitholding screwdriver with Rapidaptor quick-release chuck

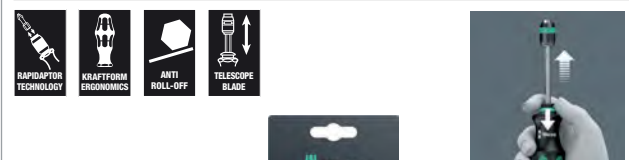

Code	EAN							
05073541001	106025		817 R				1x 1/4"x133	1

816 R Bitholding screwdriver with Rapidaptor quick-release chuck



	EAN							
Code	4013288		mm					
05051462001	099617	1/4"	119					5

816 R SB Bitholding screwdriver with Rapidaptor quick-release chuck

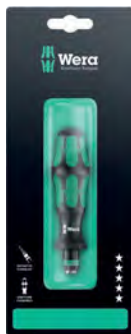

	EAN							
Code	4013288							
05073540001	106032		816 R					1
			1x 1/4"x119					

813 R Bitholding screwdriver with Rapidaptor quick-release chuck



	EAN							
Code	4013288		mm					
05051272001	103123	1/4"	90					2

393 S Bitholding screwdriver extra slim with flexible shaft

Screwdriver with bendable shaft to reach hard-to-reach areas. Thanks to the construction with a particularly slim bit holder, different screw profiles can be operated, even in very narrow work spaces. Multi-component Kraftform handle for high work speed and especially ergonomic screwdriving. With hexagon anti-roll protection to avoid rolling away.

- Flexible, bendable shaft
- Secure bit holding feature due to locking mechanism. With strong permanent magnet.
- Compact stainless steel holder for bits with 1/4"- external hexagon drive as per DIN 3126, ISO 1173 Form C 6.3 and E 6,3
- Multi-component Kraftform handle for fast and ergonomic screw-driving

393 S Bitholding screwdriver extra slim with flexible shaft



	EAN							
Code	4013288		mm	mm				
05028161001	217660	1/4"	173,5	98	6 53/64"			5

392 Bitholding screwdriver with flexible shaft

High quality bit holder with flexible shaft by Wera. Multi-component Kraftform handle for high working speeds and particularly ergonomic screwdriving.

Kraftform Plus: hard gripping zones for high working speeds whereas soft zones ensure high torque transfer. Comes with quick-release chuck for rapid bit change and hexagonal anti-roll feature that prevents any rolling away. Suitable for the insertion of bits with 1/4" hexagon head drive as per DIN ISO 1173-C 6.3.

- Bit holder with flexible shaft and quick-release chuck
- Flexible, circular blade

392 Bitholding screwdriver with flexible shaft



	EAN							
Code	4013288		mm	mm				
05028160001	041418	1/4"	177	98	7"			5

813 Bitholding screwdriver

- Bit holder for bits with 1/4" hexagon drive
- Magnetic

813 Bitholding screwdriver



	EAN					
Code	4013288		mm	mm		
05051274001	175656	1/4"	78	68		3

812/1 Bitholding screwdriver with strong permanent magnet

- Hexagonal blade, chrome-plated
- Stainless sleeve with strong permanent magnet for secure fit of the bit

812/1 Bitholding screwdriver with strong permanent magnet



	EAN						
Code	4013288		mm	mm	mm		
05051205001	012272	1/4"	120	112	10,5	4 3/4"	2

811/1 Stubby bits hand holder, magnetic

Especially small bit-holding Stubby screwdriver handle with short blade for hard to reach areas. Suitable for the mounting of bits with 1/4" hexagon drive as per DIN ISO 1173-C 6.3 and Wera connection series 1. With strong permanent magnet, which also holds large and heavy screws.

The 2-component Kraftform handle with its practical combination of hard and soft zones allows for a firm grip and precise working.

The hexagon anti-roll protection prevents annoying rolling away of bits in the workplace.

- Short compact shape for working in confined spaces
- Ergonomic 2-component Kraftform handle for precise work
- Hexagonal anti-roll feature against rolling away
- Magnetic bits hand holder for easier placement of the screws
- For 1/4" bits as per DIN ISO 1173-C 6.3

811/1 Stubby bits hand holder, magnetic



	EAN					
Code	4013288		mm	mm		
05008880001	212375	1/4"	10	54	3/6"	2

810/1 Bitholding screwdriver with retaining ring

- Bit holder with retaining ring for bits with 1/4" hexagon drive

810/1 Bitholding screwdriver with retaining ring



	EAN						
Code	4013288		mm	mm	mm		
05051005001	012258	1/4"	120	112	10,5	4 3/4"	2

Kraftform Kompakt Vario with Ratchet Function

High quality bit holder. Includes a ratchet: fine-toothing with a small return angle, switchover (right, fixed, left), maximum torque of up to 50 Newton metres.

The Rapidaptor quick-release chuck enables rapid bit change without needing any special tools. The strong permanent magnet holds the bits absolutely securely. Kraftform Plus handle for pleasant, ergonomic working that makes blisters and calluses a thing of the past.

Hard gripping zones for high working speeds whereas soft zones ensure high torque transfer. Suitable for bits with 1/4" hexagon head drive as per DIN ISO 1173-C 6.3 and E 6.3 (ISO 1173).

- Ratcheting screwdriver with Rapidaptor technology for rapid bit change
- Ratchet with fine-pitched toothing for a low return angle
- Switchover (right, fixed, left)
- Maximum torque of up to 50 Newton metres
- Multi-component Kraftform handle for fast and ergonomic screwdriving

816 RA Ratchet screwdriver



	EAN							
Code	4013288		mm					
05051461001	156280	1/4"	142,0					1

Kraftform Kompakt 60 RA



	Code	EAN						
		4013288						
	05051040001	155290						1
				816 RA 1x 1/4"x142,0				
				851/4 Z PH 1x PH 1x89; 1x PH 2x89; 1x PH 3x89				
				855/4 Z PZ 1x PZ 1x89; 1x PZ 2x89; 1x PZ 3x89				
				867/4 Z TORX® B0 1x TX 10x89; 1x TX 15x89; 1x TX 20x89; 1x TX 25x89; 1x TX 30x89				
				800/4 Z 1x 1,0x5,5x89				
				840/4 Z Hex-Plus 1x 3/32"x89; 1x 1/8"x89; 1x 5/32"x89; 1x 3/16"x89				
				868/4 Z Square-Plus 1x # 1x89; 1x # 2x89; 1x # 3x89				

Kraftform Kompakt 60 RA, imperial



	Code	EAN						
		4013288						
	05051041001	155306						1
				816 RA 1x 1/4"x142,0				
				851/4 Z PH 1x PH 1x89; 1x PH 2x89; 1x PH 3x89				
				867/4 Z TORX® B0 1x TX 10x89; 1x TX 15x89; 1x TX 20x89; 1x TX 25x89; 1x TX 30x89				
				800/4 Z 1x 1,0x5,5x89				
				840/4 Z Hex-Plus 1x 3/32"x89; 1x 1/8"x89; 1x 5/32"x89; 1x 3/16"x89				
				868/4 Z Square-Plus 1x # 1x89; 1x # 2x89; 1x # 3x89				

80 RA Vario ratchet screwdriver

Ratchet, fine-pitched toothing for a low return angle, switch-over ring (right, fixed, left), maximum torque of up to 50 Newton meters; 6 mm hexagon take-up.

Kraftform Plus handle for pleasant, ergonomic working that makes blisters and calluses a thing of the past. Hard gripping zones for high working speeds whereas soft zones ensure high torque transfer.

- Vario ratcheting screwdriver for Wera 6 mm Vario blades
- Ratchet with fine-pitched toothing for a low return angle
- Switchover ring (right, fixed, left)
- Maximum torque of up to 50 Newton metres
- Smooth hard zones for high speed turning, soft grip zones for high torque transfer

80 RA Vario ratchet screwdriver



	EAN							
Code	4013288	mm	mm					
05002901001	156242	6	115,0					1

Kraftform Kompakt Vario RA SB



Code	EAN		
05073665001	4013288 156266		1
		○ 80 RA 1x 6x115,0	
		⊕⊕ 85 1x PH 1xPH 2x175	
		⊕⊕ 86 1x PZ 1xPZ 2x175	
		⊕⊕ 87 1x TX 10xTX 15x175; 1x TX 20xTX 25x175	
		⊕⊕ 81 1x 0,6x4,0x1,0x6,0x175	
		○ 84 1x 4x5x175 ¹⁾	

¹⁾without ball-end

Kraftform Kompakt Pistol RA

Wera compact tool with multi-component Kraftform pistol handle for high working speeds and particularly ergonomic screwdriving.

Integrated bit magazine in the handle. Includes a ratchet: fine-toothing with a small return angle of only 8°, switchover (right, fixed, left), maximum torque of up to 50 Newton metres; hexagonal blade with 1/4" hexagon socket head take-up and Rapidaptor technology, magnetic. 6 bits PH, PZ and TORX® in a length of 25 mm that fit in holders as per DIN ISO 1173-D 6.3. Comes with a practical holster for belt attachment.

- Fine-toothing for a small return angle of only 8°
- Simple to use switchover ring
- Quick-release chuck with Rapidaptor technology
- Strong permanent magnet for secure fit of bits
- Multi-component Kraftform pistol handle for greater leverage effect

Kraftform Kompakt Pistol RA



Code	EAN		
05051030001	4013288 180360		1
		814 RA 1x 1/4"	
		⊕ 851/1 Z PH 1x PH 1x25; 1x PH 2x25	
		⊕ 855/1 Z PZ 1x PZ 1x25; 1x PZ 2x25	
		⊕ 867/1 TORX® 1x TX 20x25; 1x TX 25x25	

Kraftform Kompakt Pistol RA 4



Code	EAN		
05051031001	4013288 187406		1
		814 RA 1x 1/4"	
		⊕ 851/1 BTZ PH 1x PH 1x25; 1x PH 2x25	
		⊕ 855/1 BTZ PZ 1x PZ 1x25; 1x PZ 2x25	
		⊕ 867/1 TORX® BTZ 1x TX 20x25; 1x TX 25x25	
		⊕ 851/4 Z PH 1x PH 1x89; 1x PH 2x89	
		⊕ 855/4 Z PZ 1x PZ 1x89; 1x PZ 2x89	
		⊕ 867/4 Z TORX® 1x TX 20x89; 1x TX 25x89	

Kraftform Kompakt 27 RA

Wera compact tool with multi-component Kraftform handle for high working speeds and particularly ergonomic screwdriving. Integrated bit magazine in the handle.

Includes ratchet: fine-pitched for small return angle, switchover ring (right, fixed, left), maximum torque of up to 50 Nm; hexagonal blade with 1/4" hexagon socket take-up, stainless sleeve, strong permanent magnet.

- Kraftform Kompakt with ratchet function for high working speeds
- Kraftform with anti-roll feature, multi-component, integrated magazine
- Fine-pitched teeth for small return angle; switchover ring (right, fixed, left)
- Maximum torque of up to 50 Newton metres
- Hexagon blade with 1/4" hex socket take-up, stainless sleeve, strong permanent magnet

Kraftform Kompakt 27 RA 1 SB

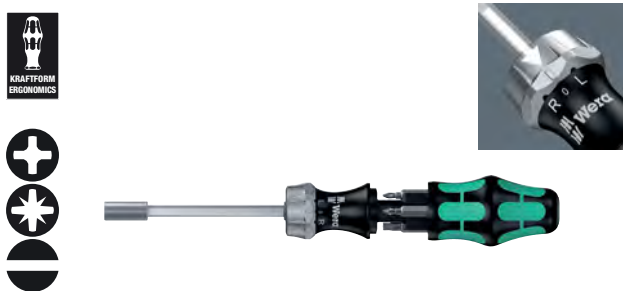

Code	EAN		
05073660001	4013288 156051		1
		⊕ 851/1 Z PH 1x PH 1x25; 1x PH 2x25	
		⊕ 855/1 Z PZ 1x PZ 1x25; 1x PZ 2x25	
		⊖ 800/1 Z 1x 1,0x5,5x25; 1x 1,2x6,5x25	

Kraftform Kompakt 27 RA 2 SB

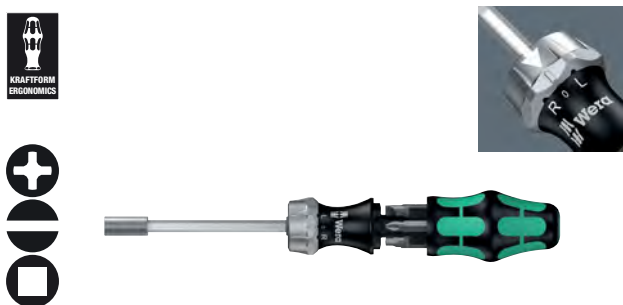

Code	EAN		
05073661002	4013288 156068		1
		⊕ 851/1 Z PH 1x PH 1x25; 1x PH 2x25	
		⊖ 800/1 Z 1x 1,0x5,5x25; 1x 1,2x6,5x25	
		□ 868/1 Z 1x # 1x25; 1x # 2x25	

88/1 Vario set

11-piece Vario set with handle and blades. In a practical belt pouch, enabling the tools to be safely and securely stored and to always be at hand. The Kraftform grip on the handle stands for pleasant, ergonomic working and makes blisters and calluses a thing of the past.

Hard gripping zones for high working speeds whereas soft zones ensure high torque transfer. The hexagonal non-roll feature prevents any annoying rolling away at the workplace. The integrated hex bolster allows higher torque to be applied with an open-end or ring spanner.

The double blades are out of high quality bit material and are therefore particularly durable. The Wera Black Point tip on the blade offers a perfect fit and optimised corrosion protection.

- Vario set with handle and 10 combination blades
- Smooth hard zones for high speed turning, soft grip zones for high torque transfer
- Chrome-plated hexagonal blade material, 6 mm
- Black Point tip offers a perfect fit with optimised corrosion protection
- In a robust belt pouch

88/1 Vario set



Code	EAN		
05002990001	4013288 000675		1
		● 80 1x 6x98	
		⊕⊕ 85 1x PH 1xPH 2x175	
		⊕⊕ 86 1x PZ 1xPZ 2x175	
		⊕⊕ 87 1x TX 10xTX 15x175; 1x TX 20xTX 25x175; 1x TX 30xTX 40x175	
		⊖⊖ 81 1x 0,6x4,0x1,0x6,0x175; 1x 0,8x5,0x1,2x7,0x175	
		⊖⊖ 84 1x 4x4x175; 1x 5x5x175; 1x 6x6x175	

80 Vario handle

- Kraftform handle with 10 mm hex bolster
- Suitable for insertion of 6 mm Vario blades or a Vario adaptor

80 Vario handle



	EAN							
Code	4013288	mm	mm	mm				
05002900001	000460	6	10	98				5

95 Vario T-handle hand holder for Vario blades

T-handle screwdriver: The ideal handle shape to allow high torque transmission in difficult tightening and loosening situations. The ergonomic shape of the handle fills the palm of the hand well, the fingers lie safely in the soft rounded handle recesses.

The whole hand makes contact with the handle and friction losses between the hand and the handle are avoided. Bit holder for bits with 1/4" external hexagon drive as per DIN ISO 1173-C 6.3 in magnetic design for easier placement of the screws.

- T-handle screwdriver for the transmission of particularly high tightening and loosening moments
- Ergonomic 2-component handle with finger handle recesses and pleasant surface feel for very high power transmission and fatigue-free working.
- Vario T-handle for 6 mm Vario blades and adaptor

95 Vario T-handle hand holder for Vario blades



	EAN							
Code	4013288	mm	mm	mm	mm			
05023400001	208446	6	60	44	100	2 ²³ / ₆₄ "		2

830 Vario bit holder adaptor

- Vario adaptor blade with quick-release chuck for Vario holder
- Suitable for take-up of bits with 1/4" hexagon head drive
- 1/4" quick-release chuck with strong permanent magnet

830 Vario bit holder adaptor



	EAN							
Code	4013288	mm	mm	mm				
05051835001	012425	1/4"	6	165	6 ⁹ / ₁₆ "			2

91 Vario extension

- Vario extension for Vario blades and adaptor
- Chrome-plated hexagonal material, 6 mm

91 Vario extension



	EAN							
Code	4013288	mm	mm	mm				
05003210001	000804	6	6	175	7"			2

712 Vario socket adaptor

- For sockets

712 Vario socket adaptor



	EAN							
Code	4013288		mm	mm				
05040001001	006165	1/4"	6	175	7"			2

Combination blades

Combination blade for Vario handles. The double-ended blades are made out of high quality bit material and are therefore particularly durable. The Wera Black Point tip offers a perfect fit and optimised corrosion protection.

81 Combination blade for slotted screws



	EAN								
Code	4013288	mm	mm	mm	mm	mm	mm		
05002910001	000477	0,6	4,0	1,0	6,0	6	175	5	
05002913001	000484	0,8	5,0	1,2	7,0	6	175	5	

82 Combination blade for slotted/Phillips screws



	EAN							
Code	4013288		mm	mm	mm	mm		
05002920001	000491	PH 1	0,6	4,0	6	175	7"	5
05002923001	000507	PH 2	1,0	6,0	6	175	7"	5
05002926001	000514	PH 3	1,2	7,0	6	175	7"	5

83 Combination blade for Phillips/Pozidriv screws



	EAN						
Code	4013288			mm	mm		
05002930001	000521	PH 1	PZ 1	6	175	7"	5
05002933001	000538	PH 2	PZ 2	6	175	7"	5

84 Combination blade for hexagon socket screws



	EAN						
Code	4013288			mm	mm		
05002936001	000545	2,5	2,5	6	175	7"	5
05002938001	000552	3	3	6	175	7"	5
05002940001	000569	4	4	6	175	7"	5
05002943001	000576	5	5	6	175	7"	5
05002948001 ¹⁾	155436	4	5	6	175	7"	5
05002946001	000583	6	6	6	175	7"	5

¹⁾without ball-end

85 Combination blade for Phillips screws



	EAN						
Code	4013288			mm	mm		
05002950001	000590	PH 1	PH 2	6	175	7"	5

86 Combination blade



	EAN						
Code	4013288			mm	mm		
05002960001	000606	PZ 1	PZ 2	6	175	7"	5
05140310001	000613	PZ 2	PZ 3	6	175	7"	5

87 Combination blade for TORX® screws



	EAN						
Code	4013288			mm	mm		
05002966001	000620	TX 6	TX 8	6	175	7"	5
05002968001	000637	TX 7	TX 9	6	175	7"	5
05002970001	000644	TX 10	TX 15	6	175	7"	5
05002973001	000651	TX 20	TX 25	6	175	7"	5
05002976001	000668	TX 30	TX 40	6	175	7"	5

68 Combination blade



	EAN						
Code	4013288			mm	mm		
05002980001	100061	#1	#2	6	175	7"	5





Roller cabinet and foam inserts



9700 Tool Rebel Roller Cabinet 1

Exclusive roller cabinet in the Tool Rebel design. Five flat and two high drawers ensure efficient, mobile organization of tools and materials.

Extremely robust thanks to a double-walled design and the completely welded construction of the entire body. For daily hard work in the workshop.

Equipped with four Wera foam inserts: 9710 foam insert screwdriver set 1, 9720 foam insert 8000 A Zyklop ratchet set 1, 9731 foam insert 6003 Joker ring spanner set 1, 9740 foam insert L-key set 1.

- Exclusive roller cabinet in the Tool Rebel design
- Extremely robust design thanks to a double-walled design
- With 7 drawers (5 flat, 2 high) – of which 2 flat drawers are equipped with foam inserts and tools (e.g. with Zyklop Speed ratchet and accessories, Joker spanners, Kraftform screwdrivers, L-keys)
- Dimensions flat drawers (width x height x depth): 522 x 81 x 398 mm
- Dimensions high drawers (width x height x depth): 522 x 166 x 398 mm
- 100 % drawer pull-out with ball bearing telescopic slides, self-closing
- All drawers are elaborately and individually layered
- Minimum risk of tilting over thanks to the drawer stop – only one drawer can be opened, no simultaneous pull-out of multiple drawers
- Both sides with square head boring
- High-quality, durable foam inserts without chemical vapours
- Optimum fit for the best possible removal of the tools from the foam inserts

9700 Tool Rebel Roller Cabinet 1



Code	EAN		
05150130001	4013288 225085		1
1x 9710 Foam insert screwdriver set 1			
	➔	932 A 1x 1.0x5.5x100; 1x 1.2x7.0x125	
	➕	350 1x PH 1x80; 1x PH 2x100; 1x PH 3x150	
	➕	350 PH Stubby/carburetor screwdriver 1x PH 2x25	
	➕	355 1x PZ 1x80; 1x PZ 2x100	
	➔	335 1x 0.8x4.0x100; 1x 1.0x5.5x125	
	➔	334 1x 1.2x6.5x150	
	➔	335 Stubby/carburetor screwdriver 1x 1.0x5.5x24,5	
	➕	2050 Micro 1x PH 0x40 ¹⁾	
	➔	2035 Micro 1x 0.40x2.5x80	
	➔	160 i VDE 1x 0.4x2.5x80 ²⁾ ; 1x 0.6x3.5x100 ²⁾	
		1441 1x 4.5-6.0x41.0	
		1442 1x 6,0-8,5x41.0	
		9810 1x 344,0x30,0x392,0 ³⁾	

1x 9720 Foam insert 8000 A Zyklus 1/4" ratchet set 1		
○	8000 A 1x 1/4"x152.0	
●○	8794 LA 1x 1/4"x150.0	
●○	8794 SA 1x 1/4"x75.0	
●○	8795 A 1x 1/4"x35.5	
●○	8794 A 1x 1/4"x56.0	
●	8790 HMA 1x 4.0x23.0; 1x 4.5x23.0; 1x 5.0x23.0; 1x 5.5x23.0; 1x 6.0x23.0; 1x 7.0x23.0; 1x 8.0x23.0; 1x 9.0x23.0; 1x 10.0x23.0; 1x 11.0x23.0; 1x 12.0x23.0; 1x 13.0x23.0; 1x 14.0x23.0; 1x 15.0x23.0	
⊗	8767 A HF 1x TX 8x28,0; 1x TX 9x28,0; 1x TX 10x28,0; 1x TX 15x28,0; 1x TX 20x28,0; 1x TX 25x28,0; 1x TX 27x28,0; 1x TX 30x28,0; 1x TX 40x28,0	
○	8740 A HF 1x 3.0x28,0; 1x 4.0x28,0; 1x 4.0x100,0; 1x 5.0x28,0; 1x 5.0x100,0; 1x 6.0x28,0; 1x 6.0x100,0; 1x 8.0x28,0; 1x 8.0x100,0	
	9820 1x 172,0x30,0x392,0 ³⁾	

1x 9731 Foam insert 6003 Joker set 1		
	6003 Joker 1x 6x105; 1x 7x110; 1x 8x115; 1x 9x120; 1x 10x125; 1x 11x135; 1x 12x148; 1x 13x160; 1x 14x167; 1x 15x174; 1x 16x182; 1x 17x190; 1x 18x210; 1x 19x230; 1x 20x230; 1x 21x260; 1x 22x260; 1x 24x280	
	Bottle opener 1x 145	
	9831 1x 344,0x30,0x392,0 ³⁾	

1x 9740 Foam insert L-key set 1		
1x 950/9 Hex-Plus Multicolour 1		
○	950 SPKL Multicolour 1x 1.5x90; 1x 2.0x101; 1x 2.5x112; 1x 3.0x123; 1x 4.0x137; 1x 5.0x154; 1x 6.0x172; 1x 8.0x195; 1x 10.0x224	

1x 967/9 TX XL Multicolour 1		
⊗	967 SXL TORX® Multicolour 1x TX 8x90; 1x TX 9x101; 1x TX 10x112	
⊗	967 SPKXL TORX® Multicolour 1x TX 15x123; 1x TX 20x137; 1x TX 25x154; 1x TX 27x172; 1x TX 30x195; 1x TX 40x224	
	1x 9500 Magnetiser SB 1x 48.0	
	1x STABILA® BM 100 Pocket tape, metric scale, 3 m, item 19570	
	1x 9840 1x 172,0x30,0x392,0 ³⁾	

¹⁾ Size 0 modified according to JCS 0 (Japanese Camera Industrial Standard)
²⁾ without Lasertip
³⁾ Attention: The foam insert does not fit in the previous model 05501051001 of the roller cabinet.

9710 Foam insert screwdriver set 1

Durable foam insert; two-coloured for quick identification of missing parts; suitable for the Tool Rebel roller cabinet, equipped with 16 Wera Kraftform screwdrivers (workshop, VDE, chiseldriver, Micro) as well as 2 screw grippers.

- Durable foam insert, each tool has its own place; two-coloured, missing tools will quickly be noticed
- High-quality, durable foam insert without chemical vapours
- Optimum fit for the best possible removal of the tools from the foam insert
- Water- and oil-repellent, low maintenance and easy to clean
- Protection of the tool from dirt and impact
- 8 Kraftform Plus screwdrivers with hard zones for high working speeds and soft handle zones for a high torque transfer
- 2 Kraftform Plus VDE screwdrivers with insulated blades for safe working up to 1,000 volt
- 2 Kraftform Micro screwdrivers with a rotating cap for fast turning
- 2 Stubby screwdrivers with short blade for hard-to-reach areas
- Two screw grippers (attachment tools with gripping function for screws)
- Width x height x depth: without tools 344 x 30 x 392 mm, with tools 344 x 47 x 392 mm

9710 Foam insert screwdriver set 1



Code	EAN		
05150101001	4013288 225122		1
		⊖	932 A 1x 1,0x5,5x100; 1x 1,2x7,0x125
		⊕	350 1x PH 1x80; 1x PH 2x100; 1x PH 3x150
		⊕	350 PH Stubby/carburetor screwdriver 1x PH 2x25
		⊕	355 1x PZ 1x80; 1x PZ 2x100
		⊖	335 1x 0,8x4,0x100; 1x 1,0x5,5x125
		⊖	334 1x 1,2x6,5x150
		⊖	335 Stubby/carburetor screwdriver 1x 1,0x5,5x24,5
		⊕	2050 Micro 1x PH 0x40 ¹⁾
		⊖	2035 Micro 1x 0,40x2,5x80
		⊖	160 i VDE 1x 0,4x2,5x80 ²⁾ ; 1x 0,6x3,5x100 ²⁾
			1441 1x 4,5-6,0x41,0
			1442 1x 6,0-8,5x41,0
			9810 1x 344,0x30,0x392,0 ³⁾

¹⁾ Size 0 modified according to JCS 0 (Japanese Camera Industrial Standard)
²⁾ without Lasertip
³⁾ Attention: The foam insert does not fit in the previous model 05501051001 of the roller cabinet.

9711 Foam insert VDE screwdriver set 1

- Screwdriver with insulated blades for safe working up to 1,000 volt, five of which with reduced blade diameter for lower-lying screws
- Two screw grippers (attachment tools with gripping function for screws)
- Width x height x depth: without tools 344 x 30 x 392 mm, with tools 344 x 46 x 392 mm

9711 Foam insert VDE screwdriver set 1



Code	EAN		
05150102001	4013288 225320		1
		⊕ 162 iS PH VDE 1x PH 1x80; 1x PH 2x100	
		⊕ 165 iS PZ VDE 1x PZ 1x80; 1x PZ 2x100	
		⊕ 165 i PZ/S VDE 1x # 2x100	
		⊖ 160 i VDE 1x 0,4x2,5x80 ¹⁾ ; 1x 0,8x4,0x100; 1x 1,0x5,5x125	
		⊖ 160 iS VDE 1x 0,6x3,5x100	
		⊗ 167 i TORX® VDE 1x TX 10x80; 1x TX 15x80; 1x TX 20x80; 1x TX 25x100; 1x TX 30x100	
		1440 1x 4,5-6,0x41,0	
		1442 1x 6,0-8,5x41,0	
		9811 1x 344,0x30,0x392,0 ²⁾	

¹⁾ without Lasertip

²⁾ Attention: The foam insert does not fit in the previous model 05501051001 of the roller cabinet.

9712 Foam insert TORX® HF screwdriver set 1

- 6 Kraftform Plus screwdrivers with hard zones for high working speeds and soft handle zones for a high torque transfer
- 4 Kraftform Micro screwdrivers with a rotating cap for fast turning
- 4 T-handle screwdrivers for the transmission of particularly high tightening and loosening moments
- Width x height x depth: without tools 344 x 30 x 392 mm, with tools 344 x 45 x 392 mm

9712 Foam insert TORX® HF screwdriver set 1



Code	EAN		
05150103001	4013288 225283		1
		⊗ 367 TORX® HF 1x TX 8x60; 1x TX 9x60; 1x TX 10x80; 1x TX 15x80; 1x TX 20x100; 1x TX 25x100	
		⊗ 2067 TORX® HF Micro 1x TX 4x40; 1x TX 5x40; 1x TX 6x40; 1x TX 7x60	
		⊗ 467 TORX® HF 1x TX 20x100; 1x TX 25x100; 1x TX 30x200; 1x TX 40x200	
		9812 1x 344,0x30,0x392,0 ¹⁾	

¹⁾ Attention: The foam insert does not fit in the previous model 05501051001 of the roller cabinet.

9713 Foam insert Hex screwdriver set 1

- 4 Kraftform Plus screwdrivers with hard zones for high working speeds and soft handle zones for a high torque transfer, two of which with hollow shaft for protruding thread rods
- 3 Kraftform Micro screwdrivers with a rotating cap for fast turning
- 5 T-handle screwdrivers for the transmission of particularly high tightening and loosening moments, with holding function for hexagonal socket screws
- With Hex-Plus profile (prevents hexagonal socket screws from cylindrical turning)
- Width x height x depth: without tools 344 x 30 x 392 mm, with tools 344 x 45 x 392 mm

9713 Foam insert Hex screwdriver set 1



Code	EAN			
05150104001	4013288 225290			1
		○	354 1x 3,0x75; 1x 4,0x75	
		○	2054 Micro 1x 1,5x60; 1x 2x60; 1x 2,5x60	
		○	454 HF 1x 4x100; 1x 5x100; 1x 6x150; 1x 8x200; 1x 10x200	
		●	395 H0 1x 10,0x90; 1x 13,0x90	
			9813 1x 344,0x30,0x392,0 ¹⁾	

¹⁾ Attention: The foam insert does not fit in the previous model 05501051001 of the roller cabinet.

9720 Foam insert 8000 A Zyklop 1/4" ratchet set 1

- The Zyklop Speed ratchet combines five ratchet types in one
- With flywheel design and slip-proof fast-rotating sleeve for extremely high working speed
- Freely pivoting ratchet head, push button release and left/right switchover
- Fine-tooth design allows a small return angle of 5°
- Can also be used as a screwdriver
- Set including sockets, bit sockets, extensions and universal joint
- 14 sockets, 9 bit sockets with holding function for TORX® screws, 9 bit sockets with holding function for hexagonal socket screws
- Width x height x depth: without tools 172 x 30 x 392 mm, with tools 172 x 40 x 392 mm

9720 Foam insert 8000 A Zyklop 1/4" ratchet set 1

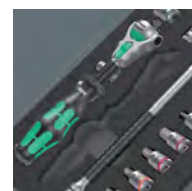

Code	EAN			
05150110001	4013288 225139			1
		□	8000 A 1x 1/4"x152,0	
		□	8794 LA 1x 1/4"x150,0	
		□	8794 SA 1x 1/4"x75,0	
		□	8795 A 1x 1/4"x35,5	
		□	8794 A 1x 1/4"x56,0	
		●	8790 HMA 1x 4,0x23,0; 1x 4,5x23,0; 1x 5,0x23,0; 1x 5,5x23,0; 1x 6,0x23,0; 1x 7,0x23,0; 1x 8,0x23,0; 1x 9,0x23,0; 1x 10,0x23,0; 1x 11,0x23,0; 1x 12,0x23,0; 1x 13,0x23,0; 1x 14,0x23,0; 1x 15,0x23,0	
		⊕	8767 A HF 1x TX 8x28,0; 1x TX 9x28,0; 1x TX 10x28,0; 1x TX 15x28,0; 1x TX 20x28,0; 1x TX 25x28,0; 1x TX 27x28,0; 1x TX 30x28,0; 1x TX 40x28,0	
		○	8740 A HF 1x 3,0x28,0; 1x 4,0x28,0; 1x 4,0x100,0; 1x 5,0x28,0; 1x 5,0x100,0; 1x 6,0x28,0; 1x 6,0x100,0; 1x 8,0x28,0; 1x 8,0x100,0	
			9820 1x 172,0x30,0x392,0 ¹⁾	

¹⁾ Attention: The foam insert does not fit in the previous model 05501051001 of the roller cabinet.



9721 Foam insert 8000 B Zyklop 3/8" ratchet set 1

- The Zyklop Speed ratchet combines five ratchet types in one
- With flywheel design and slip-proof fast-rotating sleeve for extremely high working speed
- Freely pivoting ratchet head, push button release and left/right switchover
- Fine-tooth design allows a small return angle of 5°
- Can also be used as a screwdriver
- Set including sockets, extensions and universal joint
- Width x height x depth: without tools 172 x 30 x 392 mm, with tools 172 x 45 x 392 mm

9721 Foam insert 8000 B Zyklop 3/8" ratchet set 1

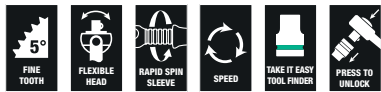

Code	EAN		
05150111001	4013288 225306		1
		☐ 8000 B 1x 3/8"x199,0	
		☐☐ 8794 SB 1x 3/8"x125,0	
		☐☐ 8794 LB 1x 3/8"x200,0	
		☐☐ 8795 B 1x 3/8"x50,0	
		☐☐ 8794 B 1x 3/8"x76,0	
		● 8790 HMB 1x 6,0x29,0; 1x 7,0x29,0; 1x 8,0x29,0; 1x 9,0x29,0; 1x 10,0x29,0; 1x 11,0x29,0; 1x 12,0x29,0; 1x 13,0x29,0; 1x 14,0x29,0; 1x 15,0x29,0; 1x 16,0x30,0; 1x 17,0x30,0; 1x 18,0x30,0; 1x 19,0x30,0; 1x 20,0x30,0; 1x 21,0x30,0; 1x 22,0x30,0; 1x 24,0x32,0	
		9821 1x 172,0x30,0x392,0 ¹⁾	

¹⁾ Attention: The foam insert does not fit in the previous model 05501051001 of the roller cabinet.

9722 Foam insert 8000 C Zyklop 1/2" ratchet set 1

- The Zyklop Speed ratchet combines five ratchet types in one
- Freely pivoting ratchet head, push button release and left/right switchover
- Fine-tooth design allows a small return angle of 5°
- Set including sockets, extensions and universal joint
- 17 sockets, 9 bit sockets with holding function for hexagonal socket screws
- Width x height x depth: without tools 344 x 30 x 392 mm, with tools 344 x 51 x 392 mm

9722 Foam insert 8000 C Zyklop 1/2" ratchet set 1

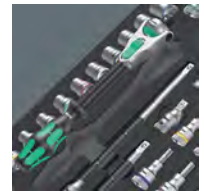
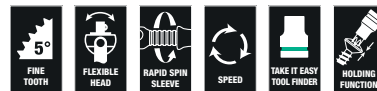

Code	EAN		
05150112001	4013288 225207		1
		☐ 8000 C 1x 1/2"x277,0	
		☐☐ 8794 LC 1x 1/2"x250,0	
		☐☐ 8794 SC 1x 1/2"x125,0	
		☐☐ 8795 C 1x 1/2"x69,0	
		☐☐ 8794 C 1x 1/2"x52,0	
		● 8790 HMC 1x 10,0x37,0; 1x 11,0x37,0; 1x 12,0x37,0; 1x 13,0x37,0; 1x 14,0x37,0; 1x 15,0x37,0; 1x 16,0x37,0; 1x 17,0x37,0; 1x 18,0x37,0; 1x 19,0x37,0; 1x 20,0x37,0; 1x 21,0x37,0; 1x 22,0x37,0; 1x 24,0x37,0; 1x 27,0x40,0; 1x 30,0x42,0; 1x 32,0x42,0	
		○ 8740 C HF 1x 4,0x60,0; 1x 4,0x140,0; 1x 5,0x60,0; 1x 5,0x140,0; 1x 6,0x60,0; 1x 6,0x140,0; 1x 7,0x60,0; 1x 8,0x60,0; 1x 10,0x60,0	
		9822 1x 344,0x30,0x392,0 ¹⁾	

¹⁾ Attention: The foam insert does not fit in the previous model 05501051001 of the roller cabinet.

9723 Foam insert Zyklus B 3/8" bit socket set 1

- Bit socket (non-impact) for manual or power tool operations
- 10 bit sockets with holding function for TORX® screws, 11 bit sockets with holding function for hexagonal socket screws, one Zyklus connector with quick-release chuck for 1/4" bits
- With Take it easy tool finder: colour coding by size
- Knurling on lower end for more grip when used manually
- Chrome-vanadium makes for hardness and strength
- Width x height x depth: without tools 172 x 30 x 392 mm, with tools 172 x 39 x 392 mm

9723 Foam insert Zyklus B 3/8" bit socket set 1



Code	EAN			
	4013288			
05150113001	225313			1
		8784 B1	1x 1/4"x3/8"x44,0	
		8767 B HF	1x TX 15x35,0; 1x TX 20x35,0; 1x TX 25x35,0; 1x TX 25x107,0; 1x TX 27x35,0; 1x TX 27x107,0; 1x TX 30x35,0; 1x TX 30x107,0; 1x TX 40x35,0; 1x TX 40x107,0	
		8740 B HF	1x 4,0x35,0; 1x 4,0x107,0; 1x 5,0x35,0; 1x 5,0x107,0; 1x 6,0x35,0; 1x 6,0x107,0; 1x 7,0x38,5; 1x 8,0x38,5; 1x 8,0x100,0; 1x 10,0x38,5; 1x 10,0x100,0	
		9823	1x 172,0x30,0x392,0 ¹⁾	

¹⁾Attention: The foam insert does not fit in the previous model 05501051001 of the roller cabinet.

9730 Foam insert 6000 Joker set 1

- Ring ratchet spanner with useful holding function by a metal plate in the mouth
- No slipping down thanks to the end stop
- Double hexagon geometry reduces the risk of slipping to the side
- Return angle of only 30°
- With Take it easy tool finder: colour coding by size
- Width x height x depth: without tools 172 x 30 x 392 mm, with tools 172 x 47 x 392 mm

9730 Foam insert 6000 Joker set 1



Code	EAN			
	4013288			
05150120001	225214			1
		6000 Joker	1x 8x144; 1x 10x159; 1x 11x165; 1x 12x170,7; 1x 13x177; 1x 14x188; 1x 15x200; 1x 16x212; 1x 17x224; 1x 18x235; 1x 19x246	
		9830	1x 172,0x30,0x392,0 ¹⁾	

¹⁾Attention: The foam insert does not fit in the previous model 05501051001 of the roller cabinet.



9731 Foam insert 6003 Joker set 1

- Ring spanner, perfect for small spaces
- The special mouth geometry expands the placement possibilities of the tool
- The low return angle in the mouth "takes" the screw every 15°
- Slim ring side with 15° crank
- With Take it easy tool finder: colour coding by size
- Iconic bottle opener with original Kraftform Plus handle
- Width x height x depth: without tools 344 x 30 x 392 mm, with tools 344 x 58 x 392 mm

9731 Foam insert 6003 Joker set 1

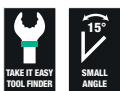

Code	EAN		
	4013288		
05150121001	225115		1
		6003 Joker 1x 6x105; 1x 7x110; 1x 8x115; 1x 9x120; 1x 10x125; 1x 11x135; 1x 12x148; 1x 13x160; 1x 14x167; 1x 15x174; 1x 16x182; 1x 17x190; 1x 18x210; 1x 19x230; 1x 20x230; 1x 21x260; 1x 22x260; 1x 24x280	
		Bottle opener 1x 145	
		9831 1x 344,0x30,0x392,0 ¹⁾	

¹⁾Attention: The foam insert does not fit in the previous model 05501051001 of the roller cabinet.

9732 Foam insert 6004 Joker set 1

- The adjustable Joker 6004 covers all metric and imperial dimensions in the respective field of application
- Automatic and continuous gripping of the hexagon screw or bolt
- Lever mechanism when gripping avoids slippage and damage
- Fast and consistent screwdriving without removing the wrench thanks to mechanical ratcheting function
- Return angle of only 30° through placement in the corner-width rectangular prisms in the mouth
- Width x height x depth: without tools 172 x 30 x 392 mm, with tools 172 x 35 x 392 mm

9732 Foam insert 6004 Joker set 1



Code	EAN		
	4013288		
05150122001	225337		1
		6004 Joker XS 1x 7-10 (1/4"-3/8")x117	
		6004 Joker S 1x 10-13 (7/16"-1/2")x154	
		6004 Joker M 1x 13-16 (1/2"-9/8")x188	
		6004 Joker L 1x 16-19 (5/8"-3/4")x224	
		6004 Joker XL 1x 19-24 (3/4"-15/16")x256	
		9832 1x 172,0x30,0x392,0 ¹⁾	

¹⁾Attention: The foam insert does not fit in the previous model 05501051001 of the roller cabinet.

9740 Foam insert L-key set 1

- Thanks to their Hex-Plus profile, the 950 L-keys let hexagonal socket screws live longer
- All L-keys with Take it easy tool finder: Colour coding by size
- All L-keys have a colour-coded, easy-grip hose sleeve for ergonomic and comfortable operation even at low temperatures
- Magnetiser 9500 for magnetising and demagnetising tool tips so that screws can be held on the tool by magnetic force
- Width x height x depth: without tools 172 x 30 x 392 mm, with tools 172 x 44 x 392 mm

9740 Foam insert L-key set 1



Code	EAN		
05150140001	4013288 225108		1

1x 950/9 Hex-Plus Multicolour 1

○	950 SPKL Multicolour 1x 1.5x90; 1x 2.0x101; 1x 2.5x112; 1x 3.0x123; 1x 4.0x137; 1x 5.0x154; 1x 6.0x172; 1x 8.0x195; 1x 10.0x224
---	---

1x 967/9 TX XL Multicolour 1

⊕	967 SXL TORX® Multicolour 1x TX 8x90; 1x TX 9x101; 1x TX 10x112
---	---

⊕	967 SPKXL TORX® Multicolour 1x TX 15x123; 1x TX 20x137; 1x TX 25x154; 1x TX 27x172; 1x TX 30x195; 1x TX 40x224
---	---

1x 9500

1x 48.0

1x STABILA®

1x STABILA® BM 100 Pocket tape, metric scale, 3 m, item 19570

1x 9840

1x 172,0x30,0x392,0 ¹⁾

¹⁾ Attention: The foam insert does not fit in the previous model 05501051001 of the roller cabinet.

9750 Foam insert Kraftform Kompakt and Tool-Check PLUS set 1

- Kraftform Kompakt 60: Folding bag with 89 mm long bits and 816 R bitholding screwdriver with Rapidaptor quick-release chuck and multi-component Kraftform handle for fatigue-free working
- Tool-Check PLUS: 39-piece tool combination of ratchet, sockets and one bitholding screwdriver
- Bitholding screwdriver extra slim with flexible shaft and very slim design for working in confined spaces
- Width x height x depth: without tools 172 x 30 x 392 mm, with tools 172 x 59 x 392 mm

9750 Foam insert Kraftform Kompakt and Tool-Check PLUS set 1

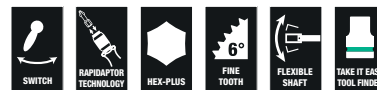

Code	EAN		
05150150001	4013288 225344		1

1x Tool-Check PLUS

⊕	8001 A 1x 1/4"x87.0
●	813 1x 1/4"x78
⊕	889/4/1 K 1x 1/4"x50
⊕	870/1 1x 1/4"x25 ¹⁾
●	8790 HMA 1x 5.5x23.0; 1x 6.0x23.0; 1x 7.0x23.0; 1x 8.0x23.0; 1x 10.0x23.0; 1x 12.0x23.0; 1x 13.0x23.0

⊕	851/1 TZ 2x PH 1x25; 3x PH 2x25; 1x PH 3x25
---	---

⊕	855/1 TH 1x PZ 1x25; 3x PZ 2x25; 1x PZ 3x25
---	---

⊕	867/1 TZ TORX® 1x TX 10x25; 1x TX 15x25; 1x TX 20x25; 1x TX 25x25; 1x TX 30x25; 1x TX 40x25
---	--

⊕	867/1 Z TORX® BO 1x TX 10x25; 1x TX 15x25; 1x TX 20x25; 1x TX 25x25; 1x TX 30x25
---	---

○	840/1 Z 1x 3.0x25; 1x 4.0x25; 1x 5.0x25; 1x 6.0x25; 1x 8.0x25
---	--

●	800/1 TZ 1x 1.0x5.5x25
---	----------------------------------

1x Kraftform Kompakt 60

●	816 R 1x 1/4"x119
---	-----------------------------

⊕	851/4 Z 1x PH 1x89; 1x PH 2x89; 1x PH 3x89
---	--

⊕	855/4 Z 1x PZ 1x89; 1x PZ 2x89; 1x PZ 3x89
---	--

⊕	867/4 Z TORX® BO 1x TX 10x89; 1x TX 15x89; 1x TX 20x89; 1x TX 25x89; 1x TX 30x89
---	---

●	800/4 Z 1x 1.0x5.5x89
---	---------------------------------

○	840/4 Z 1x 3.0x89; 1x 4.0x89; 1x 5.0x89; 1x 6.0x89
	Hook and Loop Fastener Strip 70 1x 50.0x70.0

1x 393 S Bitholding screwdriver extra slim with flexible shaft

●	1x 1/4"x173.5
---	---------------

1x 9850

1x 172,0x30,0x392,0 ²⁾

¹⁾ With friction ball; for manual nut spinner sockets

²⁾ Attention: The foam insert does not fit in the previous model 05501051001 of the roller cabinet.

9780 Foam insert KNIPEX pliers set 1

- Width x height x depth: without tools 172 x 30 x 392 mm, with tools 172 x 38 x 392 mm

9780 Foam insert KNIPEX pliers set 1



Code	EAN		
05150180001	4013288 225153		1
		KNIPEX Combination Pliers 03 05 180 1x 180	
		KNIPEX Cobra® High-Tech Water Pump Pliers 87 05 250 1x 250	
		KNIPEX High Leverage Diagonal Cutter 74 05 160 1x 160	
		9880 1x 172,0x30,0x392,0 ¹⁾	

¹⁾ Attention: The foam insert does not fit in the previous model 05501051001 of the roller cabinet.

9781 Foam insert KNIPEX pliers set 2

- Width x height x depth: without tools 172 x 30 x 392 mm, with tools 172 x 38 x 392 mm

9781 Foam insert KNIPEX pliers set 2



Code	EAN		
05150181001	4013288 225177		1
		KNIPEX Snipe Nose Cutting Pliers (Stork Beak Pliers) 26 15 200 1x 200	
		KNIPEX Mechanics' Pliers 38 25 200 1x 200	
		KNIPEX Electricians' Shears 95 05 155 1x 155	
		9881 1x 172,0x30,0x392,0 ¹⁾	

¹⁾ Attention: The foam insert does not fit in the previous model 05501051001 of the roller cabinet.

9782 Foam insert hammer set 1

- Width x height x depth: without tools 172 x 30 x 392 mm, with tools 172 x 35 x 392 mm

9782 Foam insert hammer set 1



Code	EAN		
05150182001	4013288 225191		1
		PICARD® riveting hammer 500 g, 0000101-500 1x 500,0	
		RENNSTEIG Parallel pin punches Exclusive 1x 452 003 6 RC, 3,0x150; 1x 452 004 6 RC, 4,0x150; 1x 452 006 6 RC, 6,0x150; 1x 452 008 6 RC, 8,0x150	
		RENNSTEIG Flat cold chisel 310 250 1 1x 25,0x13,0x23,0	
		9882 1x 172,0x30,0x392,0 ¹⁾	

¹⁾ Attention: The foam insert does not fit in the previous model 05501051001 of the roller cabinet.

9783 Foam insert PFERD file set 1

- Width x height x depth: without tools 344 x 30 x 392 mm, with tools 344 x 42 x 392 mm

9783 Foam insert PFERD file set 1

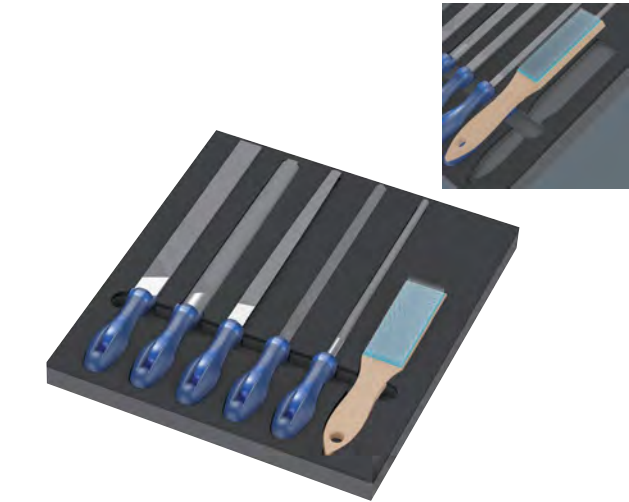

Code	EAN		
05150183001	4013288 225368		1
		PFERD machinist's file square PF1142 250 H2 1x 250	
		PFERD machinist's file half-round pointed 1152SP 250 H2 1x 250	
		PFERD machinist's file round 1162 250 H2 1x 250	
		PFERD machinist's file hand 1112 250 H2 1x 250	
		PFERD machinist's file three square 1132 250 H2 1x 250	
		PFERD scratch brush HBF steel wire Ø 0.15 1x 232	
		9883 1x 344,0x30,0x392,0 ¹⁾	

¹⁾ Attention: The foam insert does not fit in the previous model 05501051001 of the roller cabinet.





Wera 2go



Wera 2go 1 Tool Carrier

The Wera 2go 1 is the super lightweight and mobile tool carrier for all Wera pouches and textile boxes equipped with hook and loop zone on their reverse sides.

The pouches and boxes are easily and securely attached individually to the tool carrier. The hands remain free during transport thanks to the shoulder strap that is included.

- Wera 2go Tool Carrier with hook and loop fastener system
- For the docking of the Wera textile boxes and pouches with hook and loop fastener zones
- Individually configurable for greater mobility
- Hands remain free during Transport
- Includes an adjustable, detachable Shoulder Strap with a wide padded section

Wera 2go 1 Tool Carrier



Code		EAN		
05004350001	187352	4013288		1
			Wera 2go 5 1x 135,0x300,0x270,0	
			Wera 2go 6 1x 38,0x1470,0	

Wera 2go 2 Tool Container

The Wera 2go tool container is the ideal solution for individual and convenient tool transport thanks to its hook and loop fastener system and its compactness. The inner and outer hook and loop fastener zones ensure a maximum in terms of space utilisation. This means that an incredible number of tools can fit in and on the container.

Wera 2go 2 ensures a low weight since only the tools really needed for the job are taken along. The robust and dimensionally stable material protects the tools carried against damage and moisture and enhances the service life of the tool container.

The padded and width-adjustable shoulder strap and the snug fit of the container on the body mean that the container is easy and convenient to carry.

The hands remain free during transport. It comes with a quiver with an individually adjustable hook and loop fastener partition for screwdrivers and other tools.

- Wera 2go tool container with inner and outer hook and loop fastener zones
- Individually configurable for greater mobility
- Ideal also for the docking of Wera textile boxes and pouches equipped with hook and loop fastener zones

Wera 2go 2 Tool Container



Code		EAN		
05004351001	187840	4013288		1
			Wera 2go Container 1x 355,0x330,0x115,0	
			Wera 2go 6 1x 38,0x1470,0	
			Wera 2go 4 1x 165,0x165,0x105,0	

Wera 2go 2 XL Tool Container

The Wera 2go 2 XL Tool Container with extra low-profile compartments, with its hook and loop fastener system and its compactness, is the ideal solution for individual and convenient tool transport. The inner and outer hook and loop fastener zones provide extremely high flexibility and space utilization.

This fits an incredible amount of tools in and on the container. Wera 2go 2 makes for light luggage, because only the essential tools are taken.

The robust and sturdy material protects the enclosed tools from damage and moisture, and increases the service life of the tool container.

The padded and adjustable wide belt and the close-fitting position of the container provide a comfortable fit.

The hands remain free during transport. Including one Wera 2go 4 holder with individually adjustable hook and loop fastener divider for screwdrivers and other tools. Four of these holders can be stowed effortlessly.

- Wera 2go 2 XL Tool Container with extra low-profile compartments for e.g. the Wera 2go 4 Tool Quivers

Wera 2go 3 Tool Box

- Suitable for docking with the Wera 2go system
- Permanently dimensionally stable thanks to the fabric-lined plastic panels
- High resistance against cuts and stabs
- High protection for transported tools against damage and moisture
- Can be individually equipped

Wera 2go 3 Tool Box



		EAN							
Code		4013288	mm	mm	mm				
05004352001		187369	130,0	325,0	80,0				1

Wera 2go 2 XL Tool Container



		Code	EAN		
		05004357001	211491		1
				Wera 2go XL Container 1x 455,0x330,0x170,0	
				Wera 2go 6 1x 38,0x1470,0	
				Wera 2go 4 1x 165,0x165,0x105,0	



Wera 2go 4 Tool Quiver

- Suitable for docking with the Wera 2go system
- Dimensionally stable Wera 2go tool quiver
- High resistance against cuts and stabs
- Variable hook and loop fastener partition for a division into as many as 5 inner sections
- Large set-down area; handle for carrying and hanging up

Wera 2go 4 Tool Quiver



	EAN							
Code	4013288	mm	mm	mm				
05004353001	187857	165,0	165,0	105,0				1

Wera 2go 5 Tool Carrier

The Wera 2go 5 is the super lightweight and mobile tool carrier for all Wera pouches and textile boxes equipped with Velcro on their reverse sides. The pouches and boxes are easily and securely attached individually to the Wera 2go 5 article.

Wera 2go 5 Tool Carrier



	EAN							
Code	4013288	mm	mm	mm				
05004354001	187383	135,0	300,0	270,0				1

Wera 2go 6 Shoulder Strap

Shoulder strap for the Wera 2go tool transport system. It comes with extra wide, comfortable padding sections and adjustable strap length and is suitable for use with the Wera 2go 1 and 5 articles.

Wera 2go 6 Shoulder Strap



	EAN							
Code	4013288	mm	mm					
05004355001	187390	38,0	1470,0					1

Wera 2go 7 High Tool Box

- Transport box even for long tools such as spirit levels

Wera 2go 7 High Tool Box



	EAN							
Code	4013288	mm	mm	mm				
05004356001	204370	295,0	100,0	100,0				1

Wera 2go H 1 tool set for wood applications

Compact tool set with the 134 most important tools for wood-work with products by Wera, BESSEY®, “KIRSCHEN“®, KNIPEX®, Lyra®, PICARD® and Stabila®.

Mobility is made considerably easy thanks to the compact tool container from the Wera 2go system.

- Extensive 134-piece tool set in compact Wera 2go tool container for carpenters on the go
- Premium brand tools by Wera, BESSEY®, “KIRSCHEN“®, KNIPEX®, Lyra®, PICARD® and Stabila®
- Wera Kraftform Kompakt H 1 Wood (41-piece set) and Wera Bit-Safe 61 Wood 1 (61-piece set)
- 393 S extra slim bit hand holder with flexible shaft for applications in hard-to-reach work spaces
- Wera L-key with holding function: 967/9 TX XL Multicolour HF 1 (9-piece set) and 950/9 Hex-Plus Multicolour HF 1 (9-piece set)

Wera 2go H 1 tool set for wood applications



Code	EAN	
05134011001	4013288 217677	 1
		1x Wera 2go 2 Tool Container
		1x Bit-Safe 61 Wood 1
		1x Kraftform Kompakt H 1 Woodcraft
		1x 967/9 TX XL Multicolour HF 1 L-key set with holding function, long
		1x 950/9 Hex-Plus Multicolour HF 1 L-key set, metric, BlackLaser, with holding function
		1x 393 S bits hand holder extra slim with flexible shaft
		1x KNIPEX® multigrip pliers COBRA® 250 mm 87 11 250
		1x KNIPEX® combination pliers 160 mm 03 01 160
		1x KNIPEX® carpenters' pincers 210 mm 50 00 210
		1x Stabila® spirit level type 81 25 cm 02500 Torpedo
		1x Carpenters' mallet 105 mm 52-1 P
		1x “KIRSCHEN“® bevelled-edge chisel 10 mm 1001010
		1x “KIRSCHEN“® bevelled-edge chisel 16 mm 1001016
		1x “KIRSCHEN“® bevelled-edge chisel 20 mm 1001020
		1x “KIRSCHEN“® bevelled-edge chisel 26 mm 1001026
		1x BESSEY® Folding utility knife DBKPH-EU
		1x Lyra® deep hole marker 4494202
		1x Stabila® folding wooden yardstick type 601 N-S 2 m 18206
		1x PICARD® claw hammer 0008501-28

Product not available in the USA and Canada.



Wera 2go E 1 Tool set for electricians

Compact tool set with the 73 most important tools for electricians with products by Wera, Jung, KNIPEX®, Lyra®, PICARD®, PUK® and Stabila®.

Mobility is made considerably easier thanks to the compact tool container from the Wera 2go system.

- Extensive 73-piece tool set in the compact Wera 2go 2 tool container for electricians in mobile operations
- Premium brand tools by Wera, Jung, KNIPEX®, Lyra®, PICARD®, PUK® and Stabila®
- Wera Kraftform Kompakt Turbo i 1 (16-piece handle/interchangeable blades VDE set) for four times the screwdriving speed and Wera 8100 SA 6 Zyklop Speed ratchet set (1/4", 28-piece set)
- Joker 6004 S self-setting spanner for bolts and screws of 10-13mm (metric) and 7/16"-1/2" (imperial)
- With chiseldriver for screwdriving, chiselling, mortising as well as 4 VDE screwdrivers - 2 of which with stainless steel blade to prevent extraneous rust

Wera 2go E 1 Tool set for electricians



Code	EAN 4013288		
05134025001	221278	1 x Wera 2go 2 Tool Container	1
		1 x 8100 SA 6 Zyklop Speed Ratchet Set, 1/4" drive, metric	
		1 x 950/9 Hex-Plus Multicolour HF 1 L-key set, metric, BlackLaser, with holding function	
		1 x Kraftform Kompakt Turbo i 1	
		1x 932 A Screwdriver for slotted screws 1.2x7.0x125	
		1x 3162 i PH VDE Insulated screwdriver for Phillips screws, stainless PH 2x100	
		1x 3165 i PZ VDE Insulated screwdriver for Pozidriv screws, stainless PZ 2x100	
		1x 160 i VDE Insulated screwdriver for slotted screws 1.2x6.5x150	
		1x 160 iS VDE Insulated screwdriver with reduced blade diameter for slotted screws 0.6x3.5x100	
		1x 6004 Joker S self-setting spanner 10-13x7/16"-1/2"x154	
		1 x KNIPEX® Combination pliers 160mm 01 06 160	
		1 x KNIPEX® Diagonal insulation stripper 14 26 160	
		1 x KNIPEX® Snipe nose pliers with blade (stork beak pliers) 26 16 200	
		1 x KNIPEX® Cobra® VDE Hightech water pump pliers, insulated, 87 26 250	
		1 x KNIPEX® Cable knife 98 52	
		1 x KNIPEX® ErgoStrip® Universal dismantling tool 16 95 01	
		1 x PUK® 2200 Hand saw frame	
		1 x Lyra® Construction marker DRY PROFI 4494202	
		1 x STABILA® Spirit level Pocket Electric 17775	
		1 x STABILA® Spirit level type 70, 30 cm, 02281	
		1 x STABILA® Wooden folding rule type 607, 2 m, yellow, 01104	
		1 x PICARD® Fitter's hammer 400 g, German shape, 000101-0400	
		1 x Jung Plastering cup 127mm, 946 127 00	
		1 x Jung Scraping knife with natural wood handle, 922 050 00	

Hook and Loop Fastener Strip 1



Code	EAN		
05670446001	189448		1
		K70 1x 50,0x70,0	

Hook and Loop Fastener Strip 2



Code	EAN		
05670447001	189455		1
		K120 1x 50,0x120,0	

Hook and Loop Fastener Strip 3



Code	EAN		
05670448001	189462		1
		K240 1x 50,0x240,0	





Bits



Impaktor system - For an above-average service life



The Impaktor technology offers an above-average service life even under extreme circumstances.

Enhanced friction resistance, thanks to the rough diamond-particle coating on the bit tip, prevents any slipping out of the screw head.

Particularly suitable for use with customary impact drivers. 1/4" hexagon, suitable for holders as per DIN ISO 1173-D 6.3.

851/1 IMP DC PH DIY Impaktor PH bits



Code	EAN		
	4013288		
05057615001	178695	+	851/1 IMP DC 10x PH 1x25
05057616001	157638	+	851/1 IMP DC 10x PH 2x25
05057617001	157645	+	851/1 IMP DC 10x PH 3x25

851/1 IMP DC SB Impaktor bits



Code	EAN		
	4013288		
05073916001	158369	+	851/1 IMP DC 1x PH 2x25
05073917001	158376	+	851/1 IMP DC 1x PH 3x25

Bit-Box 15 Impaktor PH



Code	EAN		
	4013288		
05057752001	187918	+	851/1 IMP DC 15x PH 2x25

Kraftform Stainless - stainless steel to prevent rust

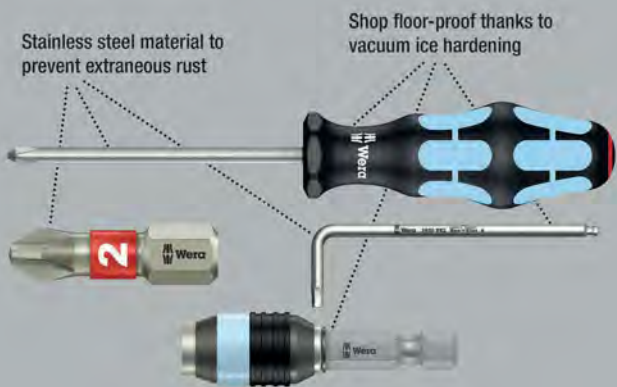

High quality bits out of stainless steel for cross-recess screws. Wera stainless are made out of stainless steel which prevents the formation of unsightly extraneous rust. Come with Torsion zone: Torsion bits take-up torque peaks and absorb them in the Torsion zone. This prevents premature wear and extends the service life of the bit. 1/4" hexagon, suitable for holders as per DIN ISO 1173-D 6.3.

3851/1 TS bits, stainless



Code	EAN					
	4013288					
05071010001	110985	+	PH 1	25	1"	10
05071011001	110992	+	PH 2	25	1"	10
05071012001	111005	+	PH 3	25	1"	10

3851/1 TS SB bits, stainless



Code	EAN			
	4013288			
05073610001	112132	+	3851/1 TS PH 1x PH 1x25	5
05073611001	112149	+	3851/1 TS PH 1x PH 2x25	5

BiTorsion system - for longer service life

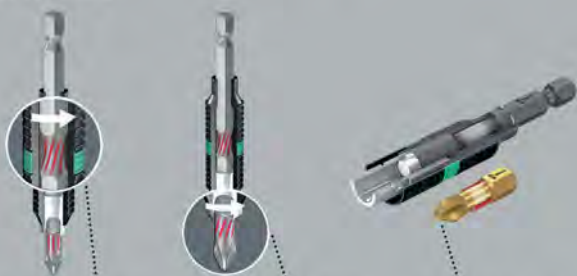

Smaller impacts are absorbed by the holder

Higher impacts are cushioned in the torsion zone of the bit

No premature wear caused by impacts

851/1 BDC bits

Bits with tiny diamond particles on the bit tip. This ensures a secure fit of the bit in the screw, reduces the contact pressure required and lowers the risk of slipping.

Comes with Torsion zone – where kinetic energy is diverted from peak loads – and softer BiTorsion zone to prevent the bit tip from twisting under peak loads. This greatly extends the product service life; 1/4" hexagon, suitable for holders as per DIN ISO 1173-D 6.3.

851/1 BDC bits



Code	EAN	+	1"	1"				
	4013288		mm					
05056400001	033970	PH 1	25	1"				10
05056402001	033987	PH 2	25	1"				10
05056404001	033994	PH 3	25	1"				10

851/1 BDC SB bits



Code	EAN	+		
	4013288			
05073332001	029324	+	851/1 BDC PH 1x PH 1x25	5
05073333001	029331	+	851/1 BDC PH 1x PH 2x25	5
05073334001	029348	+	851/1 BDC PH 1x PH 3x25	5
05073335001	029355	+	851/1 BDC PH 2x PH 2x25	5

851/1 BTH bits

Bits with Torsion zone – where kinetic energy is diverted from peak loads – and softer BiTorsion zone to prevent the bit tip from twisting under peak loads.

This greatly extends the product service life. Extra-hard design, 1/4" hexagon, suitable for holders as per DIN ISO 1173-D 6.3.

851/1 BTH bits



Code	EAN	+	1"	1"				
	4013288		mm					
05056410001	034243	PH 1	25	1"				10
05056412001	034250	PH 2	25	1"				10
05056414001	034267	PH 3	25	1"				10



851/1 BTZ bits

Bits with Torsion zone – where kinetic energy is diverted from peak loads – and softer BiTorsion zone to prevent the bit tip from twisting under peak loads. This greatly extends the product service life. Tough viscous, 1/4" hexagon, suitable for holders as per DIN ISO 1173-D 6.3.

851/1 BTZ bits



Code	EAN	+	mm	1"				
	4013288		mm					
05056420001	034458	PH 1	25	1"				10
05056422001	034465	PH 2	25	1"				10
05056424001	034472	PH 3	25	1"				10

Bit-Box 20 BTZ PH



Code	EAN	+	851/1 BTZ PH				
	4013288						
05057751001	187956		20x PH 2x25				10

Diamond-coated bits

Minute diamond particles on the tip of the tool literally bite into the screw

Bits fit securely into the head of the screw

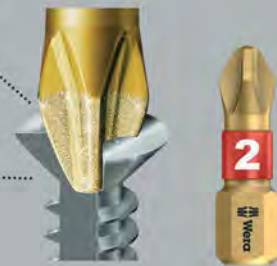

The diamond coating of the bits ensures a secure fit in the screw, reduces the contact pressure required and lowers the risk of slipping.

Profiled version with especially sharp edges which break away the paint when e.g. screw profiles are covered in it and this ensures a dependable transfer of power between the bit and screw.

1/4" hexagon, suitable for holders as per DIN ISO 1173-D 6.3.

851/1 A bits

Extra-hard design. Profiled version. 1/4" hexagon, suitable for holders as per DIN ISO 1173-D 6.3.

851/1 A bits



Code	EAN	+	mm	1"	mm			
	4013288		mm		mm			
05134919001	099976	PH 1	25	1"	4,5			10
05134920001	099983	PH 2	25	1"	6,0			10
05134921001	099990	PH 3	25	1"	-			10

851/1 RDC bits

High quality bits for drywall screws. Reduced shaft diameter for low-lying screw connections. Countersinking of screws without any surface damage.

Especially for drywall construction. The diamond coating of the bits ensures a secure fit in the screw, reduces the contact pressure required and lowers the risk of slipping. 1/4" hexagon, suitable for holders as per DIN ISO 1173-D 6.3.

851/1 RDC bits



	EAN	+	mm	1"	mm		
Code	4013288		mm		mm		
05135008001	032904	PH 2	25	1"	4,2		10

851/1 RH bits

Bits with reduced shaft diameter for low-lying screw connections. Countersinking of screws without any surface damage. Tough viscous for universal use. 1/4" hexagon, suitable for holders as per DIN ISO 1173-D 6.3.

851/1 RH bits



	EAN	+	mm	1"	mm		
Code	4013288		mm		mm		
05346281001	107176	PH 2	25	1"	4,2		10

851/1 RZ bits

Bits for drywall screws. Reduced shaft diameter for low-lying screw connections. Tough viscous for universal use. 1/4" hexagon, suitable for holders as per DIN ISO 1173-D 6.3.

851/1 RZ bits



	EAN	+	mm	1"	mm		
Code	4013288		mm		mm		
05135009001	032799	PH 2	25	1"	4,2		10

851/1 RZ SB bits



	EAN	+	851/1 RZ PH	
Code	4013288			
05135005001	038456	+	851/1 RZ PH 2x PH 2x25	5

851/1 TH bits

The Torsion design means that torque peaks can be absorbed. This prevents premature wear and enhances the service life. Extra-hard; 1/4" hexagon, suitable for holders as per DIN ISO 1173-D 6.3.

851/1 TH bits



	EAN	+	mm	1"			
Code	4013288		mm				
05056605001	013545	PH 1	25	1"			10
05056610001	013552	PH 2	25	1"			10
05056625001	013569	PH 3	25	1"			10



851/1 TiN bits

Extra-hard titanium nitride (TiN) coating for withstanding permanent loads such as e.g. in industrial applications.
1/4" hexagon, suitable for holders as per DIN ISO 1173-D 6.3.

851/1 TiN bits



Code	EAN	+	□	□					
05480172001	040992	PH 2	25	1"					10

851/1 TZ bits

- Ductile and tough for hard materials
- Torsion design against premature wear

851/1 TZ bits



Code	EAN	+	□	□					
05056505001	013606	PH 1	25	1"					10
05056510001	013613	PH 2	25	1"					10
05056525001	013620	PH 3	25	1"					10

851/1 TZ SB bits



Code	EAN	+							
05073323001	029249	+	851/1 TZ PH	2x PH 1x25					5
05073324001	029256	+	851/1 TZ PH	2x PH 2x25					5
05073325001	029263	+	851/1 TZ PH	2x PH 3x25					5
05073326001	029270	+	851/1 TZ PH	1x PH 1x25; 1x PH 2x25; 1x PH 3x25					5

851/1 Z bits

- Ductile and tough for hard materials

851/1 Z bits



Code	EAN	+	□	□					
05056500001	013323	PH 0	25	1"					10
05072070001	013453	PH 1	25	1"					10
05056507001	013330	PH 1	50	2"					10
05072072001	013460	PH 2	25	1"					10
05056515001	013347	PH 2	32	1 1/4"					10
05056520001	013354	PH 2	50	2"					10
05072074001	013477	PH 3	25	1"					10
05134905001	094858	PH 3	50	2"					10
05056535001	013378	PH 4	32	1 1/4"					10

851/1 Z SB bits



Code	EAN	+							
05073304001	029058	+	851/1 Z PH	2x PH 1x25					5
05073305001	029065	+	851/1 Z PH	2x PH 2x25					5
05073306001	029072	+	851/1 Z PH	2x PH 3x25					5
05073307001	029089	+	851/1 Z PH	1x PH 1x25; 1x PH 2x25; 1x PH 3x25					5

851/1 Z DIY bits



Code	EAN	+							
05072400001	115737	+	851/1 Z PH	10x PH 1x25					1
05072401001	115744	+	851/1 Z PH	10x PH 2x25					1
05072402001	115751	+	851/1 Z PH	10x PH 3x25					1

851/1 Z DIY 100 bits



Code		EAN		851/1 Z PH 100x PH 2x25	1
05072441001		4013288 138477			

Bit-Box 20 PH



Code		EAN		851/1 Z PH 20x PH 2x25	20
05057750001		4013288 188014			

851/1 J bits

Bits optimised for Asian PH screws. Similar to Camera screws. Tough viscous for universal use. 1/4" hexagon, suitable for holders as per DIN ISO 1173-D 6.3.



Code	EAN	+	mm	mm	mm	
05135040001 ¹⁾	112569	PH 00	25	1"	2,0	10
05135041001 ²⁾	112576	PH 0	25	1"	2,5	10

¹⁾Size 00 modified according to JCIS 00 (Japanese Camera Industrial Standard)
²⁾Size 0 modified according to JCIS 0 (Japanese Camera Industrial Standard)

Impaktor system - For an above-average service life



The Impaktor technology offers an above-average service life even under extreme circumstances. Enhanced friction resistance, thanks to the rough diamond-particle coating on the bit tip, prevents any slipping out of the screw head.

Particularly suitable for use with customary impact drivers. 1/4" hexagon, suitable for holders as per DIN ISO 1173-F 6.3.

851/4 IMP DC PH DIY Impaktor PH bits



Code		EAN		851/4 IMP DC 5x PH 2x50	1
05057656001		4013288 157652			
05057657001		157669		851/4 IMP DC 5x PH 3x50	1



851/4 IMP DC SB Impaktor bits



Code	EAN			
	4013288			
05073956001	158482	+	851/4 IMP DC 1x PH 2x50	5
05073957001	158499	+	851/4 IMP DC 1x PH 3x50	5

Kraftform Stainless - stainless steel to prevent rust



High quality bits out of stainless steel for cross-recess screws. Wera stainless are made out of stainless steel which prevents the formation of unsightly extraneous rust. 1/4" hexagon, suitable for holders as per DIN ISO 1173-F 6.3.

3851/4 Bits, stainless



Code	EAN	+	□	□				
	4013288		mm					
05071081001	115485	PH 1	89	3 1/2"				10
05071082001	115492	PH 2	89	3 1/2"				10
05071083001	115508	PH 3	89	3 1/2"				10

BiTorsion system - for longer service life



Smaller impacts are absorbed by the holder

Higher impacts are cushioned in the torsion zone of the bit

No premature wear caused by impacts

851/4 BDC bits

BiTorsion bits with tiny diamond particles on the bit tip. This ensures a secure fit of the bit in the screw, reduces the contact pressure required and lowers the risk of slipping. Comes with Torsion zone – where kinetic energy is diverted from peak loads – and softer BiTorsion zone to prevent the bit tip from twisting under peak loads. This greatly extends the product service life; 1/4" hexagon, suitable for holders as per DIN ISO 1173-F 6.3.

851/4 BDC bits

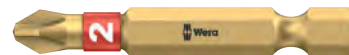

Code	EAN	+	□	□				
	4013288		mm					
05059530001	034090	PH 1	50	2"				10
05059532001	034106	PH 2	50	2"				10
05059534001	034113	PH 3	50	2"				10

851/4 BTH bits

BiTorsion bits with elastic Torsion zone – where kinetic energy is diverted from peak loads – and softer BiTorsion zone to prevent the bit tip from twisting under peak loads.

This greatly extends the product service life; 1/4" hexagon, suitable for holders as per DIN ISO 1173-F 6.3.

851/4 BTH bits



Code	EAN	+	mm	mm			
05059540001	034304	PH 1	50	2"			10
05059542001	034311	PH 2	50	2"			10
05059544001	034328	PH 3	50	2"			10

851/4 BTZ bits

BiTorsion with elastic Torsion zone – where kinetic energy is diverted from peak loads – and softer BiTorsion zone to prevent the bit tip from twisting under peak loads.

This greatly extends the product service life. Tough viscous for universal use; 1/4" hexagon, suitable for holders as per DIN ISO 1173-F 6.3.

851/4 BTZ bits

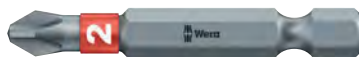

Code	EAN	+	mm	mm			
05059550001	034571	PH 1	50	2"			10
05059552001	034588	PH 2	50	2"			10
05059554001	034595	PH 3	50	2"			10

851/4 RH Reduced tip bits

Bits with reduced shaft diameter for low-lying screw connections, enabling countersinking of screws without any surface damage. Profiled version. Extra-hard. 1/4" hexagon, suitable for holders as per DIN ISO 1173-F 6.3.

851/4 RH Reduced tip bits



Code	EAN	+	mm	mm	mm		
05380161001	157065	PH 2	50	2"	4,2		10

851/4 A bits

The sharp-edged profile ensures a dependable transfer of power between the bit and screw by breaking off the paint e.g. when screw profiles are covered in it.

Extra-hard design: 1/4" hexagon, suitable for holders as per DIN ISO 1173-F 6.3.

851/4 A bits



Code	EAN	+	mm	mm	mm		
05134929001	105165	PH 0	50	2"	3		10
05134906001	105141	PH 0	70	2 3/4"	3		10
05134907001	105172	PH 0	89	3 1/2"	3		10
05134930001	100009	PH 1	50	2"	4,5		10
05134370001	037831	PH 1	70	2 3/4"	4,5		10
05134372001	037855	PH 1	89	3 1/2"	4,5		10
05134931001	100016	PH 2	50	2"	6		10
05134371001	037848	PH 2	70	2 3/4"	6		10
05134373001	037862	PH 2	89	3 1/2"	6		10
05134910001 ¹⁾	105202	PH 2	152	6"	6		10
05134911001 ²⁾	105219	PH 2	152	6"	6		10
05134932001	100023	PH 3	50	2"	-		10
05134913001	105233	PH 3	70	2 3/4"	8		10
05134914001	105240	PH 3	89	3 1/2"	8		10
05134915001	105257	PH 3	152	6"	8		10
05160983001	106575	PH 4	50	2"	10		10

¹⁾Length of drive 100 mm

²⁾Length of drive 20 mm



851/4 R Reduced tip bits

High quality bits with reduced shaft diameter for low-lying screw connections, enabling countersinking of screws without any surface damage. Profiled version. Extra-hard. 1/4" hexagon, suitable for holders as per DIN ISO 1173-F 6.3.

851/4 R Reduced tip bits



Code	EAN	+	mm	mm	mm		
05160899001	105547	PH 2	50	2"	3,0		10
05160896001	105554	PH 2	152	6"	3,0		10

851/4 TH bits

High quality bits with Torsion zone – where kinetic energy is diverted from peak loads. This greatly extends the product service life. Extra-hard; 1/4" hexagon, suitable for holders as per DIN ISO 1173-F 6.3.

851/4 TH bits



Code	EAN	+	mm	mm			
05059855001	013897	PH 1	50	2"			10
05059860001	013903	PH 2	50	2"			10
05059865001	013910	PH 3	50	2"			10

851/4 TZ bits

Bits with Torsion zone – where kinetic energy is diverted from peak loads. This greatly extends the product service life. Tough viscous, for universal use. 1/4" hexagon, suitable for holders as per DIN ISO 1173-F 6.3.

851/4 TZ bits



Code	EAN	+	mm	mm			
05059805001	013927	PH 1	50	2"			10
05059810001	013934	PH 2	50	2"			10
05059815001	013941	PH 3	50	2"			10

851/4 TZ SB bits



Code	EAN	+				
05134380001	037947	+	851/4 TZ PH	2x PH 1x50		3
05134381001	037954	+	851/4 TZ PH	2x PH 2x50		3
05134382001	037961	+	851/4 TZ PH	2x PH 3x50		3

851/4 J bits

Bits optimised for Asian PH screws. In particular, for applications with very small dimensions pursuant to the Japanese Camera Industrial Standard.

Tough viscous for universal use. 1/4" hexagon, suitable for holders as per DIN ISO 1173-F 6.3.

851/4 J bits



Code	EAN	+	mm	mm	mm		
05135530001 ¹⁾	113252	PH 00	50	2"	2,0		10
05380200001 ¹⁾	156204	PH 00	89	3 1/2"	2,0		10
05135531001 ²⁾	113269	PH 0	50	2"	2,5		10
05380201001 ²⁾	156211	PH 0	89	3 1/2"	2,5		10
05135532001	113276	PH 1	50	2"	4,5		10
05380202001	156228	PH 1	89	3 1/2"	4,5		10

¹⁾ Optimised for Asian PH screws

²⁾ Size 0 modified according to JCS 0 (Japanese Camera Industrial Standard)

851/4 Z PH Take it easy bits

Premium bits for Phillips screws. Tough, for universal use. 1/4" hexagonal, suitable for holders as per DIN ISO 1173-F 6.3.

- Take it easy tool finder: colour coding according to profile and size

851/4 Z PH Take it easy bits



	EAN	+	⌀	⌀	⌀		
Code	4013288		mm	⌀	mm		
05059564001	226457	PH 1	89	3 1/2"	4,5		10
05059565001	226464	PH 2	89	3 1/2"	6,0		10

851/4 Z bits

Tough viscous for universal use. 1/4" hexagon, suitable for holders as per DIN ISO 1173-F 6.3.

851/4 Z bits



	EAN	+	⌀	⌀	⌀		
Code	4013288		mm	⌀	mm		
05059755001	013781	PH 1	70	2 3/4"	4,5		10
05059760001	013798	PH 1	89	3 1/2"	4,5		10
05059765001	031044	PH 1	127	5"	4,5		10
05059766001	031051	PH 1	152	6"	4,5		10
05059770001	013804	PH 2	70	2 3/4"	6,0		10
05059775001	013811	PH 2	89	3 1/2"	6,0		10
05059780001	013828	PH 2	110	4 3/8"	6,0		10
05059785001	030474	PH 2	127	5"	6,0		10
05059786001	031068	PH 2	152	6"	6,0		10
05059790001	013835	PH 3	70	2 3/4"	-		10
05059795001	013842	PH 3	89	3 1/2"	-		10
05059800001	013859	PH 3	110	4 3/8"	-		10
05059802001	031075	PH 3	152	6"	-		10

851/4 PH Ni Bits

- Chemically nickel-plated

851/4 PH Ni Bits



	EAN	+	⌀	⌀			
Code	4013288		mm	⌀			
05059574001	226617	PH 3	89	3 1/2"			10

851/4 Z SB bits



Code	EAN	+		
	4013288			
05073520001	105875	+	851/4 Z PH 1x PH 1x89	5
05136305001	213839	+	851/4 Z PH 1x PH 1x152	3
05073521001	105882	+	851/4 Z PH 1x PH 2x89	5
05136306001	213846	+	851/4 Z PH 1x PH 2x152	3
05073522001	105899	+	851/4 Z PH 1x PH 3x89	5
05136307001	213853	+	851/4 Z PH 1x PH 3x152	3

853/4 ACR® SL bits with sleeve, magnetized

Bits with rough ribs (anti cam-out feature, ACR) to prevent any slipping out of the screw head, permanently magnetized, thus screws can be held securely on the tip of the bit; with plastic sleeve, protects components from being damaged when screwdriving.

Tough viscous for universal use. 1/4" hexagon, suitable for holders as per DIN ISO 1173-F 6.3.

853/4 ACR® SL bits with sleeve, magnetized



	EAN	+	⌀	⌀	⌀		
Code	4013288		mm	⌀	mm		
05323780001	165190	PH 2	50	2"	5,2		40
05323781001	165206	PH 2	90	3 1/2"	5,2		40
05203913001	163189	PH 2	150	6"	5,2		40
05203914001	163196	PH 2	200	8"	5,2		60

853/4 Harpoon ACR® bits

Bits with reduced shaft diameter for low-lying screw connections. Countersinking of screws without any surface damage. Come with rough ribs (anti cam-out feature, ACR) to prevent any slipping out of the screw head.

Tough viscous for universal use. 1/4" hexagon, suitable for holders as per DIN ISO 1173-F 6.3.

853/4 Harpoon ACR® bits



	EAN	+	mm	mm	mm		
Code	4013288		mm		mm		
05160901001	105592	PH 2	50	2"	3,3		10
05160895001	105608	PH 2	70	2 3/4"	3,3		10
05160908001	105615	PH 2	152	6"	3,3		10

851/2 Z bits

For universal use. 5/16" hexagon, suitable for holders as per DIN ISO 1173-D 8.

851/2 Z bits



	EAN	+	mm	mm	mm		
Code	4013288		mm		mm		
05057705001	013668	PH 1	32	1 1/4"	4,5		10
05057710001	013675	PH 2	32	1 1/4"	6,0		10
05057715001	013682	PH 3	32	1 1/4"	7,6		10
05057720001	013699	PH 4	32	1 1/4"	-		10

851/11 Bits

With thread drive M 4.

851/11 Bits



	EAN	+	mm	mm	mm		
Code	4013288		mm		mm		
05065081001	014245	PH 2	33	1 1/4"	6,0		5

851/12 Bits

Tough viscous for universal use. Thread drive M 5.

851/12 Bits



	EAN	+	mm	mm	mm		
Code	4013288		mm		mm		
05065110001	014252	PH 2	33	1 1/4"	7,0		5
05065112001	014269	PH 2	35	1 3/8"	7,0		5
05065114001	014276	PH 2	44,5	1 3/4"	6,0		5

851/16 bits

Thread drive #10-32 UNF.

851/16 bits



	EAN	+	mm	mm	mm		
Code	4013288		mm		mm		
05065197001	014351	PH 2	44,5	1 3/4"	6,0		5

851/9 C J PH bits, halfmoon

With 4 mm halfmoon drive. Optimised for Japanese PH screws. Hard design.

851/9 C J PH bits, halfmoon



	EAN	+	mm	mm	mm	mm	mm	
Code	4013288		mm		mm	mm	mm	
05134605001 ¹⁾	190444	PH 000	44	1 47/64"	1,5	20	25/32"	10
05135270001 ¹⁾	112729	PH 00	44	1 47/64"	1,8	20	25/32"	10
05135271001 ¹⁾	112736	PH 00	64	2 33/64"	1,8	20	25/32"	10
05135272001 ²⁾	112743	PH 0	44	1 47/64"	1,8	20	25/32"	10
05135273001 ²⁾	112750	PH 0	64	2 33/64"	1,8	20	25/32"	10
05135276001 ¹⁾	112781	PH 1	44	1 47/64"	3,0	20	25/32"	10
05135277001 ¹⁾	112798	PH 1	64	2 33/64"	3,0	20	25/32"	10

¹⁾ Optimised for Asian PH screws

²⁾ Size 0 modified according to JCIS 0 (Japanese Camera Industrial Standard)

851/21 J bits

With HIOS 4 mm drive. Optimised for Japanese PH screws. Hard design.

851/21 J bits



Code	EAN	+	mm	mm	mm		
05135280001 ¹⁾	112804	PH 00	40	1 9/16"	1,8		10
05135281001 ¹⁾	112811	PH 00	60	2 3/8"	1,8		10
05135284001 ²⁾	112828	PH 0	40	1 9/16"	1,8		10
05135285001 ²⁾	112835	PH 0	60	2 3/8"	1,8		10

¹⁾Size 00 modified according to JCIS 00 (Japanese Camera Industrial Standard)

²⁾Size 0 modified according to JCIS 0 (Japanese Camera Industrial Standard)

Impaktor system - For an above-average service life



High quality bits for Pozidriv screws. The Impaktor technology offers an above-average service life even under extreme circumstances. Enhanced friction resistance, thanks to the rough diamond-particle coating on the bit tip, prevents any slipping out of the screw head. Particularly suitable for use with customary impact drivers. 1/4" hexagon, suitable for holders as per DIN ISO 1173-D 6.3.

855/1 IMP DC PZ DIY Impaktor bits



Code	EAN	+		
05057620001	178718	+	855/1 IMP DC 10x PZ 1x25	1
05057621001	157676	+	855/1 IMP DC 10x PZ 2x25	1
05057622001	157683	+	855/1 IMP DC 10x PZ 3x25	1

855/1 IMP DC SB Impaktor bits



Code	EAN	+		
05073921001	158383	+	855/1 IMP DC 1x PZ 2x25	5
05073922001	158390	+	855/1 IMP DC 1x PZ 3x25	5

Bit-Box 15 Impaktor PZ



Code	EAN	+		
05057763001	187901	+	855/1 IMP DC 15x PZ 2x25	10



Kraftform Stainless - stainless steel to prevent rust

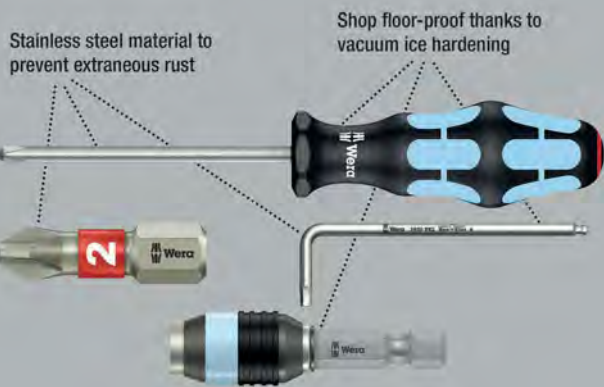

High quality bits out of stainless steel for Pozidriv screws. Wera stainless are made out of stainless steel which prevents the formation of unsightly extraneous rust. Come with Torsion zone: Torsion bits take-up torque peaks and absorb them in the Torsion zone. This prevents premature wear and extends the service life of the bit. 1/4" hexagon, suitable for holders as per DIN ISO 1173-D 6.3.

3855/1 TS bits, stainless



Code	EAN	✳	⌀	ℓ					
	4013288		mm						
05071020001	111012	PZ 1	25	1"					10
05071021001	111029	PZ 2	25	1"					10
05071022001	111036	PZ 3	25	1"					10

3855/1 TS SB bits, stainless



Code	EAN	✳							
	4013288								
05073613001	112101	✳	3855/1 TS PZ						5
			1x PZ 1x25						
05073614001	112118	✳	3855/1 TS PZ						5
			1x PZ 2x25						
05073615001	112125	✳	3855/1 TS PZ						5
			1x PZ 3x25						

BiTorsion system - for longer service life

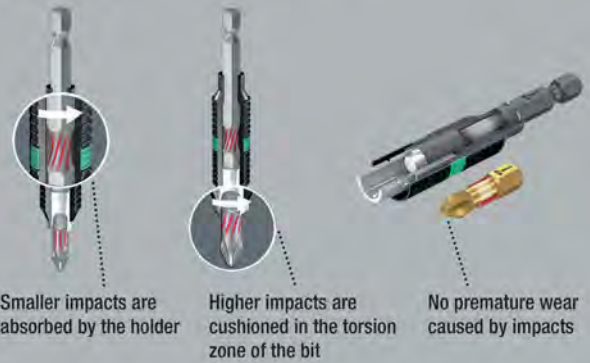

855/1 BDC bits

Bits with tiny diamond particles on the bit tip. This ensures a secure fit of the bit in the screw, reduces the contact pressure required and lowers the risk of slipping.

Comes with Torsion zone – where kinetic energy is diverted from peak loads – and softer BiTorsion zone to prevent the bit tip from twisting under peak loads. This greatly extends the product service life; 1/4" hexagon, suitable for holders as per DIN ISO 1173-D 6.3.

855/1 BDC bits



Code	EAN	✳	⌀	ℓ					
	4013288		mm						
05056700001	034007	PZ 1	25	1"					10
05056702001	034014	PZ 2	25	1"					10
05056704001	034021	PZ 3	25	1"					10

855/1 BDC SB bits



Code	EAN			
	4013288			
05073336001	029362	+	855/1 BDC PZ 1x PZ 1x25	5
05073337001	029379	+	855/1 BDC PZ 1x PZ 2x25	5
05073338001	029386	+	855/1 BDC PZ 1x PZ 3x25	5
05073339001	029393	+	855/1 BDC PZ 2x PZ 2x25	5

855/1 BTH bits

BiTorsion bits with elastic Torsion zone – where kinetic energy is diverted from peak loads – and softer BiTorsion zone to prevent the bit tip from twisting under peak loads. This greatly extends the product service life. This provides the best possible durability together with the matching holder. Extra-hard; 1/4" hexagon, suitable for holders as per DIN ISO 1173-D 6.3.

855/1 BTH bits



Code	EAN		⌀	ℓ				
	4013288		mm					
05056710001	034274	PZ 1	25	1"				10
05056712001	034281	PZ 2	25	1"				10
05056714001	034298	PZ 3	25	1"				10

Bit-Box 20 BTH PZ



Code	EAN			
	4013288			
05057762001	187963	+	855/1 BTH PZ 20x PZ 2x25	10

855/1 BTZ bits

BiTorsion bits with elastic Torsion zone – where kinetic energy is diverted from peak loads – and softer BiTorsion zone to prevent the bit tip from twisting under peak loads. This greatly extends the product service life. Tough, for universal use; 1/4" hexagon, suitable for holders as per DIN ISO 1173-D 6.3.

855/1 BTZ bits



Code	EAN		⌀	ℓ				
	4013288		mm					
05056720001	034489	PZ 1	25	1"				10
05056722001	034496	PZ 2	25	1"				10
05056724001	034502	PZ 3	25	1"				10

Bit-Box 20 BTZ PZ



Code	EAN			
	4013288			
05057761001	187970	+	855/1 BTZ PZ 20x PZ 2x25	10



855/1 RZ bits

Reduced shaft diameter for low-lying screw connections. Countersinking of screws without any surface damage. Especially for drywall construction and suitable for drywall screws.

855/1 RZ bits



Code	EAN	✳	⌀	⌀	⌀		
Code	4013288		mm		mm		
05135017001	175311	PZ 1	25	1"	4,2		10
05135003001	096739	PZ 2	25	1"	4,2		10

855/1 TH bits

With Torsion zone – where kinetic energy is diverted from peak loads. This greatly extends the product service life. Extra-hard; 1/4" hexagon, suitable for holders as per DIN ISO 1173-D 6.3.

855/1 TH bits



Code	EAN	✳	⌀	⌀			
Code	4013288		mm				
05056910001	014740	PZ 1	25	1"			10
05056915001	014757	PZ 2	25	1"			10
05056925001	014764	PZ 3	25	1"			10

855/1 TH SB bits



Code	EAN	✳					
Code	4013288						
05073370001	029638	✳	855/1 TH PZ 2x PZ 1x25				5
05073371001	029645	✳	855/1 TH PZ 2x PZ 2x25				5
05073372001	029652	✳	855/1 TH PZ 2x PZ 3x25				5
05073373001	029669	✳	855/1 TH PZ 1x PZ 1x25; 1x PZ 2x25; 1x PZ 3x25				5

855/1 TiN bits

With extra-hard titanium nitride (TiN) coating for withstanding permanent loads such as e.g. in industrial applications.

1/4" hexagon, suitable for holders as per DIN ISO 1173-D 6.3.

855/1 TiN bits



Code	EAN	✳	⌀	⌀			
Code	4013288		mm				
05480222001	041029	PZ 2	25	1"			10

855/1 TZ bits

With Torsion zone to combat premature wear.

Tough viscous for universal use. 1/4" hexagon, suitable for holders as per DIN ISO 1173-D 6.3.

855/1 TZ bits



Code	EAN	✳	⌀	⌀			
Code	4013288		mm				
05056810001	014801	PZ 1	25	1"			10
05056815001	014818	PZ 2	25	1"			10
05056825001	014825	PZ 3	25	1"			10

855/1 Z bits

Tough viscous for universal use. 1/4" hexagon, suitable for holders as per DIN ISO 1173-D 6.3.

855/1 Z bits



Code	EAN	✳	⌀	⌀			
Code	4013288		mm				
05056805001	014535	PZ 0	25	1"			10
05072080001	014658	PZ 1	25	1"			10
05056812001	014542	PZ 1	50	2"			10
05072082001	014665	PZ 2	25	1"			10
05056820001	014559	PZ 2	50	2"			10
05072084001	014672	PZ 3	25	1"			10
05056835001	014573	PZ 4	32	1 1/4"			10

855/1 Z SB bits



Code	EAN			
	4013288			
05073308001	029096	+	855/1 Z PZ 2x PZ 1x25	5
05073309001	029102	+	855/1 Z PZ 2x PZ 2x25	5
05073310001	029119	+	855/1 Z PZ 2x PZ 3x25	5
05073380001	029621	+	855/1 Z PZ 1x PZ 4x32	5
05073311001	029126	+	855/1 Z PZ 1x PZ 1x25; 1x PZ 2x25; 1x PZ 3x25	5

855/1 Z DIY bits



Code	EAN			
	4013288			
05072403001	115768	+	855/1 Z PZ 10x PZ 1x25	1
05072404001	115775	+	855/1 Z PZ 10x PZ 2x25	1
05072405001	115782	+	855/1 Z PZ 10x PZ 3x25	1

855/1 Z DIY 100 bits



Code	EAN			
	4013288			
05072443001	138484	+	855/1 Z PZ 100x PZ 1x25	1
05072444001	138491	+	855/1 Z PZ 100x PZ 2x25	1

Bit-Box 20 PZ



Code	EAN			
	4013288			
05057760001	188052	+	855/1 Z PZ 20x PZ 2x25	20

Impaktor system - For an above-average service life



The Impaktor technology offers an above-average service life even under extreme circumstances. Enhanced friction resistance, thanks to the rough diamond-particle coating on the bit tip, prevents any slipping out of the screw head.

Particularly suitable for use with customary impact drivers. 1/4" hexagon, suitable for holders as per DIN ISO 1173-F 6.3.

855/4 IMP DC PZ DIY Impaktor bits



Code	EAN			
	4013288			
05057661001	157690	+	855/4 IMP DC 5x PZ 2x50	1
05057662001	157706	+	855/4 IMP DC 5x PZ 3x50	1



855/4 IMP DC Impaktor bits SB



Code	EAN		
	4013288		
05073961001	158505	855/4 IMP DC 1x PZ 2x50	5
05073962001	158512	855/4 IMP DC 1x PZ 3x50	5

Kraftform Stainless - stainless steel to prevent rust



High quality bits out of stainless steel which prevents the formation of unsightly extraneous rust. 1/4" hexagon, suitable for holders as per DIN ISO 1173-F 6.3.

3855/4 Bits, stainless



Code	EAN		mm		
	4013288				
05071084001	115515	PZ 1	89	3 1/2"	10
05071085001	115522	PZ 2	89	3 1/2"	10
05071086001	115539	PZ 3	89	3 1/2"	10

BiTorsion system - for longer service life

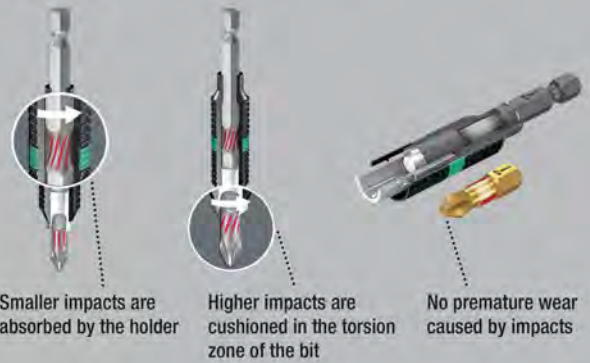

855/4 BDC bits

Bits with tiny diamond particles on the bit tip. This ensures a secure fit of the bit in the screw, reduces the contact pressure required and lowers the risk of slipping.

Comes with Torsion zone – where kinetic energy is diverted from peak loads – and softer BiTorsion zone to prevent the bit tip from twisting under peak loads. This greatly extends the product service life; 1/4" hexagon, suitable for holders as per DIN ISO 1173-F 6.3.

855/4 BDC bits

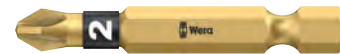

Code	EAN		mm		
	4013288				
05059900001	034120	PZ 1	50	2"	10
05059902001	034137	PZ 2	50	2"	10
05059904001	034144	PZ 3	50	2"	10

855/4 BTH bits

Bits with elastic Torsion zone – where kinetic energy is diverted from peak loads – and softer BiTorsion zone to prevent the bit tip from twisting under peak loads.

This greatly extends the product service life. This provides the best possible durability together with the matching holder. Extra-hard; 1/4" hexagon, suitable for holders as per DIN ISO 1173-F 6.3.

855/4 BTH bits

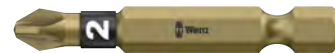

Code	EAN		mm		
	4013288				
05059910001	034335	PZ 1	50	2"	10
05059912001	034342	PZ 2	50	2"	10
05059914001	034359	PZ 3	50	2"	10

855/4 BTZ bits

BiTorsion bits fwith elastic Torsion zone – where kinetic energy is diverted from peak loads – and softer BiTorsion zone to prevent the bit tip from twisting under peak loads.

This greatly extends the product service life. Tough viscous for universal use; 1/4" hexagon, suitable for holders as per DIN ISO 1173-F 6.3.

855/4 BTZ bits



Code	EAN	✳	⌀	ℓ	ℓ	⊠
05059920001	034601	PZ 1	50	2"		10
05059922001	034618	PZ 2	50	2"		10
05059924001	034625	PZ 3	50	2"		10

855/4 TH bits

Bits with Torsion zone – where kinetic energy is diverted from peak loads. This greatly extends the product service life. Extra-hard; 1/4" hexagon, suitable for holders as per DIN ISO 1173-F 6.3.

855/4 TH bits



Code	EAN	✳	⌀	ℓ	ℓ	⊠
05060055001	015068	PZ 1	50	2"		10
05060060001	015075	PZ 2	50	2"		10
05060065001	015082	PZ 3	50	2"		10

855/4 TZ bits

High quality bits with Torsion zone – where kinetic energy is diverted from peak loads.

This greatly extends the product service life. Tough viscous, for universal use. 1/4" hexagon, suitable for holders as per DIN ISO 1173-F 6.3.

855/4 TZ bits



Code	EAN	✳	⌀	ℓ	ℓ	⊠
05060005001	015099	PZ 1	50	2"		10
05060010001	015105	PZ 2	50	2"		10
05060015001	015112	PZ 3	50	2"		10

855/4 TZ SB bits



Code	EAN	✳	⌀	ℓ	ℓ	⊠
05134384001	037985	PZ 1	50	2"		3
05134385001	037992	PZ 2	50	2"		3
05134386001	038005	PZ 3	50	2"		3

855/4 Z PZ Take it easy bits

Premium bits for Pozidriv* screws. Tough, for universal use. 1/4" hexagonal, suitable for holders as per DIN ISO 1173-F 6.3. * Pozidriv = registered trademark of the company European Industrial Service Ltd.

- Take it easy tool finder: colour coding according to profile and size

855/4 Z PZ Take it easy bits



Code	EAN	✳	⌀	ℓ	ℓ	⊠
05059566001	226471	PZ 1	89	3 1/2"	4,5	10
05059567001	226488	PZ 2	89	3 1/2"	6,0	10



855/4 Z bits

Tough viscous for universal use. 1/4" hexagon, suitable for holders as per DIN ISO 1173-F 6.3.

855/4 Z bits



Code	EAN	✳	⌈	⌋	∅			
Code	4013288		mm		mm			
05060027001	014955	PZ 1	70	2 3/4"	4,5			10
05060029001	014962	PZ 1	89	3 1/2"	4,5			10
05060031001	031426	PZ 1	127	5"	4,5			10
05060030001	031259	PZ 1	152	6"	4,5			10
05060033001	014979	PZ 2	70	2 3/4"	6,0			10
05060035001	014986	PZ 2	89	3 1/2"	6,0			10
05060037001	014993	PZ 2	110	4 3/8"	6,0			10
05060036001	031440	PZ 2	127	5"	6,0			10
05060038001	031297	PZ 2	152	6"	6,0			10
05060041001	015006	PZ 3	70	2 3/4"	-			10
05060043001	015013	PZ 3	89	3 1/2"	-			10
05060045001	015020	PZ 3	110	4 3/8"	-			10
05060047001	031433	PZ 3	152	6"	-			10

855/4 Z SB bits



Code	EAN	✳						
Code	4013288							
05073523001	105905	✳	855/4 Z PZ	1x PZ 1x89				5
05073524001	106452	✳	855/4 Z PZ	1x PZ 2x89				5
05073525001	105912	✳	855/4 Z PZ	1x PZ 3x89				5
05136308001	213860	✳	855/4 Z PZ	1x PZ 1x152				3
05136309001	213877	✳	855/4 Z PZ	1x PZ 2x152				3
05136310001	213884	✳	855/4 Z PZ	1x PZ 3x152				3

855/4 PZ Ni Bits

- Chemically nickel-plated

855/4 PZ Ni Bits



Code	EAN	✳	⌈	⌋	∅			
Code	4013288		mm					
05059575001	226624	PZ 3	89	3 1/2"				10

855/2 Z bits

5/16" hexagon, suitable for holders as per DIN ISO 1173-D 8.

855/2 Z bits



Code	EAN	✳	⌈	⌋	∅			
Code	4013288		mm		mm			
05058005001	014863	PZ 1	32	1 1/4"	4,5			10
05058010001	014870	PZ 2	32	1 1/4"	6,0			10
05058015001	014887	PZ 3	32	1 1/4"	7,6			10
05058020001	014894	PZ 4	32	1 1/4"	-			10

855/11 Bits

With thread drive M 4.

855/11 Bits



Code	EAN	✳	⌈	⌋	∅			
Code	4013288		mm		mm			
05065096001	015426	PZ 2	33	1 1/4"	6,0			5

855/12 Bits

With thread drive M 5.

855/12 Bits



Code	EAN	✳	⌈	⌋	∅			
Code	4013288		mm		mm			
05065129001	015457	PZ 2	44,5	1 3/4"	6,0			5

851/4 PH/S PlusMinus bits

Bits with combination profile Phillips/slotted. In electrical applications screws with mixed geometry (slotted and Phillips cross-recess) are quite common.

Bits having a PlusMinus profile are optimum for addressing these screws. Tough viscous for universal use. 1/4" hexagon, suitable for holders as per DIN ISO 1173-F 6.3.

851/4 PH/S PlusMinus bits



	EAN					
Code	4013288		mm		mm	
05059720001	102577	# 1	70	2 3/4"	4,5	10
05059721001	102584	# 2	70	2 3/4"	6	10

855/4 PZ/S PlusMinus bits

Bits with combination profile slotted and Pozidriv, particularly for jobs on terminal blocks, fuse boxes, switches and relays.

Tough viscous for universal use. 1/4" hexagon, suitable for holders as per DIN ISO 1173-F 6.3.

855/4 PZ/S PlusMinus bits



	EAN					
Code	4013288		mm		mm	
05059896001	102591	# 1	70	2 3/4"	4,5	10
05059897001	102607	# 2	70	2 3/4"	6	10

Impaktor system - For an above-average service life



High quality bits for recessed TORX® screws. The Impaktor technology offers an above-average service life even under extreme circumstances. Enhanced friction resistance, thanks to the rough diamond-particle coating on the bit tip, prevents any slipping out of the screw head.

Particularly suitable for use with customary impact drivers. 1/4" hexagon, suitable for holders as per DIN ISO 1173-D 6.3.

867/1 IMP DC TORX® DIY Impaktor bits



Code	EAN		
	4013288		
05057628001	178688		1
		867/1 IMP DC 10x TX 10x25	
05057623001	169242		1
		867/1 IMP DC 10x TX 15x25	
05057624001	163165		1
		867/1 IMP DC 10x TX 20x25	
05057625001	157447		1
		867/1 IMP DC 10x TX 25x25	
05057626001	157454		1
		867/1 IMP DC 10x TX 30x25	
05057627001	157461		1
		867/1 IMP DC 10x TX 40x25	

867/1 IMP DC SB Impaktor bits



Code	EAN		
	4013288		
05073924001	163240		5
		867/1 IMP DC 1x TX 20x25	
05073925001	158406		5
		867/1 IMP DC 1x TX 25x25	
05073926001	158413		5
		867/1 IMP DC 1x TX 30x25	
05073927001	158420		5
		867/1 IMP DC 1x TX 40x25	

Bit-Box 15 Impaktor TX



Code	EAN		
	4013288		
05057772001	187871		10
		867/1 IMP DC 15x TX 20x25	
05057775001	187888		10
		867/1 IMP DC 15x TX 25x25	
05057776001	187895		10
		867/1 IMP DC 15x TX 30x25	



Kraftform Stainless - stainless steel to prevent rust



High quality bits out of stainless steel for recessed TORX® screws. Prevent the formation of unsightly extraneous rust.

Come with Torsion zone: Torsion bits take-up torque peaks and absorb them in the Torsion zone. This prevents premature wear and extends the service life of the bit. 1/4" hexagon, suitable for holders as per DIN ISO 1173-D 6.3.

3867/1 TS TORX® bits, stainless



Code	EAN		mm	inch				
05071030001	111043	TX 8	25	1"				10
05071032001	111067	TX 10	25	1"				10
05071033001	111074	TX 15	25	1"				10
05071034001	111081	TX 20	25	1"				10
05071035001	111098	TX 25	25	1"				10
05071037001	111111	TX 30	25	1"				10
05071038001	111128	TX 40	25	1"				10

3867/1 TS SB TORX® bits, stainless



Code	EAN			
05073620001	117670		3867/1 TS TORX® 1x TX 10x25	5
05073621001	117687		3867/1 TS TORX® 1x TX 15x25	5
05073622001	117694		3867/1 TS TORX® 1x TX 20x25	5
05073623001	117700		3867/1 TS TORX® 1x TX 25x25	5
05073625001	117724		3867/1 TS TORX® 1x TX 30x25	5

BiTorsion system - for longer service life



Smaller impacts are absorbed by the holder

Higher impacts are cushioned in the torsion zone of the bit

No premature wear caused by impacts

867/1 BDC TORX® bits

Bits with tiny diamond particles on the bit tip. This ensures a secure fit of the bit in the screw, reduces the contact pressure required and lowers the risk of slipping.

Come with a Torsion zone – where kinetic energy is diverted from peak loads – and softer BiTorsion zone to prevent the bit tip from twisting under peak loads. This greatly extends the product service life. 1/4" hexagon, suitable for holders as per DIN ISO 1173-D 6.3.

867/1 BDC TORX® bits



Code	EAN								
	4013288			mm					
05066100001	034038	TX 10	25	1"					10
05066102001	034045	TX 15	25	1"					10
05066104001	034052	TX 20	25	1"					10
05066106001	034069	TX 25	25	1"					10
05066108001	034076	TX 30	25	1"					10
05066110001	034083	TX 40	25	1"					10

867/1 BDC SB TORX® bits



Code	EAN								
	4013288								
05134374001	099778		867/1 TORX® BDC	1x TX 10x25					5
05134375001	099785		867/1 TORX® BDC	1x TX 15x25					5
05134376001	099792		867/1 TORX® BDC	1x TX 20x25					5
05134377001	099808		867/1 TORX® BDC	1x TX 25x25					5
05134378001	099822		867/1 TORX® BDC	1x TX 30x25					5
05134379001	099815		867/1 TORX® BDC	1x TX 40x25					5

867/1 BTZ TORX® bits

BiTorsion bits with an elastic Torsion zone – where kinetic energy is diverted from peak loads – and softer BiTorsion zone to prevent the bit tip from twisting under peak loads. This greatly extends the product service life. This provides the best possible durability together with the matching holder.

Tough viscous for universal use. 1/4" hexagon, suitable for holders as per DIN ISO 1173-D 6.3.

867/1 BTZ TORX® bits



Code	EAN								
	4013288			mm					
05066120001	034519	TX 10	25	1"					10
05066122001	034526	TX 15	25	1"					10
05066124001	034533	TX 20	25	1"					10
05066126001	034540	TX 25	25	1"					10
05066128001	034557	TX 30	25	1"					10
05066130001	034564	TX 40	25	1"					10

867/1 TORX® HF Bits with holding function

- For TORX® socket screws
- Holding function for recessed TORX® screws
- Also suitable for Würth ASSY screws as well as Altenloh SPAX T-STAR plus screws
- 1/4" hexagon drive (Wera connecting series 1)
- With Take it easy tool finder: colour coding by size

867/1 TORX® HF Bits with holding function



Code	EAN								
	4013288			mm					
05066140001	226334	TX 10	25	1"					10
05066141001	226341	TX 15	25	1"					10
05066142001	226365	TX 20	25	1"					10
05066143001	226358	TX 25	25	1"					10
05066144001	226389	TX 30	25	1"					10
05066145001 ¹⁾	226655	TX 40	25	1"					10

¹⁾ Pound-thru hexagonal; no Take it easy.



Bit-Box 20 TX HF



Code	EAN			
	4013288			
05057777001	226013		867/1 TORX® HF 20x TX 20x25	20
05057778001	226020		867/1 TORX® HF 20x TX 25x25	20

867/1 TZ TORX® bits

With a Torsion zone – where kinetic energy is diverted from peak loads. This greatly extends the product service life.

Tough viscous for universal use. 1/4" hexagon, suitable for holders as per DIN ISO 1173-D 6.3.

867/1 TZ TORX® bits



Code	EAN						
	4013288		mm		mm		
05066300001	015709	TX 5	25	1"	4,2		10
05066301001	015716	TX 6	25	1"	4,2		10
05066302001	015723	TX 7	25	1"	4,2		10
05066303001	015730	TX 8	25	1"	4,2		10
05066304001	015747	TX 9	25	1"	4,2		10
05066305001	015754	TX 10	25	1"	4,2		10
05066308001	015761	TX 15	25	1"	4,2		10
05066310001	015778	TX 20	25	1"	4,8		10
05066312001	015785	TX 25	25	1"	5,5		10
05066313001	015792	TX 27	25	1"	5,5		10
05066315001	015808	TX 30	25	1"	6,0		10
05066320001	015815	TX 40	25	1"	-		10

867/1 TORX® bits



Code	EAN						
	4013288		mm		mm		
05135140001	107114	TX 1	25	1"	1,5		10
05135141001	107121	TX 2	25	1"	1,5		10
05135142001	111456	TX 3	25	1"	2,0		10
05135143001	111463	TX 4	25	1"	2,0		10
05066492001	030405	TX 5	25	1"	3,0		10
05066493001	030412	TX 6	25	1"	3,0		10
05066494001	030429	TX 7	25	1"	3,0		10
05066495001	030436	TX 8	25	1"	3,0		10
05066496001	030443	TX 9	25	1"	3,0		10
05066485001	030320	TX 10	25	1"	4,0		10
05066486001	030337	TX 15	25	1"	4,0		10
05066487001	030344	TX 20	25	1"	5,0		10
05066488001	030351	TX 25	25	1"	5,0		10
05066489001	030368	TX 27	25	1"	6,0		10
05066490001	030375	TX 30	25	1"	6,0		10
05066491001	030382	TX 40	25	1"	-		10
05066325001	031174	TX 45	35	1 3/8"	8,0		10
05066330001	031181	TX 50	35	1 3/8"	9,0		10
05066335001	031167	TX 55	35	1 3/8"	12,0		10

867/1 SB TORX® bits



Code	EAN					
	4013288					
05073313001	029140		867/1 TORX® 2x TX 10x25			5
05073340001	029591		867/1 TORX® 2x TX 15x25			5
05073314001	029157		867/1 TORX® 2x TX 20x25			5
05073315001	029164		867/1 TORX® 2x TX 25x25			5
05073316001	029171		867/1 TORX® 2x TX 30x25			5
05073317001	029188		867/1 TORX® 2x TX 40x25			5
05073346001	125859		867/1 TORX® 1x TX 50x35			5
05073375001	037503		867/1 TORX® 1x TX 10x25; 1x TX 15x25; 1x TX 20x25			5
05073376001	037510		867/1 TORX® 1x TX 25x25; 1x TX 30x25; 1x TX 40x25			5

867/1 DIY TORX® bits



Code	EAN			
	4013288			
05072406001	115799		867/1 TORX® 10x TX 10x25	1
05072407001	115805		867/1 TORX® 10x TX 15x25	1
05072408001	115812		867/1 TORX® 10x TX 20x25	1
05072409001	115829		867/1 TORX® 10x TX 25x25	1
05072411001	115843		867/1 TORX® 10x TX 30x25	1
05072412001	115850		867/1 TORX® 10x TX 40x25	1

867/1 TORX® DIY 100



Code	EAN			
	4013288			
05072446001	138507		867/1 TORX® 100x TX 10x25	1
05072447001	138514		867/1 TORX® 100x TX 15x25	1
05072448001	138521		867/1 TORX® 100x TX 20x25	1
05072449001	138538		867/1 TORX® 100x TX 25x25	1
05072451001	138552		867/1 TORX® 100x TX 30x25	1
05072452001	138569		867/1 TORX® 100x TX 40x25	1

Bit-Box 20 TX



Code	EAN			
	4013288			
05057770001	187994		867/1 TORX® 20x TX 20x25	20
05057773001	188007		867/1 TORX® 20x TX 25x25	20

867/1 Z TORX® Wedge bits

The conical design of the profile means that a wedging effect is generated that holds the TORX® screw securely on the bit.

Tough viscous for universal use. 1/4" hexagon, suitable for holders as per DIN ISO 1173-D 6.3.

867/1 Z TORX® Wedge bits



Code	EAN								
	4013288		mm						
05066455001	016034		TX 15	25	1"				10
05066460001	016041		TX 20	25	1"				10
05066465001	016058		TX 25	25	1"				10



867/1 ZA TORX® bits with central pin

Come with a pin which, together with the bore hole within the screw, makes it easier to centre the tool.

Tough viscous for universal use. 1/4" hexagon, suitable for holders as per DIN ISO 1173-D 6.3.

867/1 ZA TORX® bits with central pin



Code	EAN						
Code	4013288		mm	1"	mm		
05066081001	107190	TX 15	25	1"	4,0		10
05066082001	107206	TX 20	25	1"	5,0		10
05066083001	107213	TX 25	25	1"	5,0		10

Impaktor system - For an above-average service life



The Impaktor technology offers an above-average service life even under extreme circumstances. Enhanced friction resistance, thanks to the rough diamond-particle coating on the bit tip, prevents any slipping out of the screw head.

Particularly suitable for use with customary impact drivers. 1/4" hexagon, suitable for holders as per DIN ISO 1173-F 6.3.

867/4 IMP DC TORX® DIY Impaktor bits



Code	EAN			
	4013288			
05057664001	163172		867/4 IMP DC 5x TX 20x50	1
05057665001	157515		867/4 IMP DC 5x TX 25x50	1
05057666001	157522		867/4 IMP DC 5x TX 30x50	1
05057667001	157539		867/4 IMP DC 5x TX 40x50	1

867/4 IMP DC SB Impaktor bits



Code	EAN			
	4013288			
05073964001	163257		867/4 IMP DC 1x TX 20x50	5
05073965001	158529		867/4 IMP DC 1x TX 25x50	5
05073966001	158536		867/4 IMP DC 1x TX 30x50	5
05073967001	158543		867/4 IMP DC 1x TX 40x50	5



867/4 Z TORX® bits

Premium bits for TORX® socket screws. Tough, for universal use. 1/4" hexagonal, suitable for holders as per DIN ISO 1173-F 6.3.

867/4 Z TORX® bits



	EAN						
Code	4013288		mm		mm		
05135200001	107138	TX 1	50	2"	2,0		10
05135201001	107145	TX 2	50	2"	2,0		10
05135202001	112620	TX 3	50	2"	2,0		10
05135204001	041333	TX 4	50	2"	3,0		10
05135205001	031808	TX 5	50	2"	3,0		10
05308428001	041340	TX 6	50	2"	3,0		10
05134740001	035905	TX 6	70	2 3/4"	3,0		10
05332600001	033895	TX 6	89	3 1/2"	3,0		10
05328448001	038432	TX 6	152	6"	3,0		10
05160830001	113283	TX 7	50	2"	3,0		10
05345047001	128423	TX 7	70	2 3/4"	3,0		10
05060131001	030498	TX 8	50	2"	3,0		10
05060098001	030504	TX 8	70	2 3/4"	3,0		10
05060185001	030511	TX 8	89	3 1/2"	3,0		10
05060195001	030528	TX 8	152	6"	3,0		10
05319835001	128430	TX 9	70	2 3/4"	3,0		10
05060193001	155566	TX 9	89	3 1/2"	3,0		10
05060194001	156945	TX 9	152	6"	3,0		10
05060132001	030535	TX 10	50	2"	4,0		10
05060100001	016171	TX 10	70	2 3/4"	4,0		10
05060186001	030481	TX 10	89	3 1/2"	4,0		10
05060196001	030542	TX 10	152	6"	4,0		10
05060133001	030559	TX 15	50	2"	4,0		10
05060105001	016188	TX 15	70	2 3/4"	4,0		10
05060187001	030566	TX 15	89	3 1/2"	4,0		10
05060197001	030573	TX 15	152	6"	4,0		10
05060134001	030580	TX 20	50	2"	4,5		10
05060110001	016195	TX 20	70	2 3/4"	4,5		10
05060188001	030597	TX 20	89	3 1/2"	4,5		10
05060198001	030603	TX 20	152	6"	4,5		10
05060135001	030610	TX 25	50	2"	6,0		10
05060115001	016201	TX 25	70	2 3/4"	6,0		10
05060189001	030627	TX 25	89	3 1/2"	6,0		10
05060199001	030634	TX 25	152	6"	6,0		10
05060136001	030641	TX 27	50	2"	6,0		10
05060120001	016218	TX 27	70	2 3/4"	6,0		10
05060190001	030658	TX 27	89	3 1/2"	6,0		10
05060200001	030665	TX 27	152	6"	6,0		10
05060137001	030672	TX 30	50	2"	6,0		10
05060125001	016225	TX 30	70	2 3/4"	6,0		10
05060191001	030689	TX 30	89	3 1/2"	6,0		10
05060201001	030696	TX 30	152	6"	6,0		10
05060138001	030702	TX 40	50	2"	-		10
05060130001	016232	TX 40	70	2 3/4"	-		10
05060192001	030719	TX 40	89	3 1/2"	-		10
05060202001	030726	TX 40	152	6"	-		10

867/4 Z SB Bits



Code	EAN			
	4013288			
05073720001	132789		867/4 Z TORX® 2x TX 10x50	3
05073526001	105929		867/4 Z TORX® 1x TX 10x89	5
05073470001	226273		867/4 Z TORX® 3x TX 10x89	1
05136311001	213891		867/4 Z TORX® 1x TX 10x152	3
05073721001	132796		867/4 Z TORX® 2x TX 15x50	3
05073527001	105936		867/4 Z TORX® 1x TX 15x89	5
05073471001	226228		867/4 Z TORX® 3x TX 15x89	1
05136312001	213907		867/4 Z TORX® 1x TX 15x152	3
05073722001	132802		867/4 Z TORX® 2x TX 20x50	3
05073528001	105943		867/4 Z TORX® 1x TX 20x89	5
05073472001	226235		867/4 Z TORX® 3x TX 20x89	1
05136313001	213914		867/4 Z TORX® 1x TX 20x152	3
05073723001	132826		867/4 Z TORX® 2x TX 25x50	3
05073529001	105950		867/4 Z TORX® 1x TX 25x89	5
05073473001	226242		867/4 Z TORX® 3x TX 25x89	1
05136314001	213921		867/4 Z TORX® 1x TX 25x152	3
05073724001	132833		867/4 Z TORX® 2x TX 30x50	3
05073530001	105967		867/4 Z TORX® 1x TX 30x89	5
05073474001	226259		867/4 Z TORX® 3x TX 30x89	1
05136315001	213938		867/4 Z TORX® 1x TX 30x152	3
05073531001	105974		867/4 Z TORX® 1x TX 40x89	5
05136316001	213945		867/4 Z TORX® 1x TX 40x152	3

867/2 Z TORX® bits

⁵/₁₆" hexagon, suitable for holders as per DIN ISO 1173-D 8.

867/2 Z TORX® bits



	EAN						
Code	4013288		mm		mm		
05066901001	016096	TX 20	35	1 ³ / ₈ "	4,5		10
05066900001	016102	TX 25	35	1 ³ / ₈ "	5,8		10
05066902001	016119	TX 27	35	1 ³ / ₈ "	5,8		10
05066905001	016126	TX 30	35	1 ³ / ₈ "	6,0		10
05066910001	016133	TX 40	35	1 ³ / ₈ "	7,0		10
05066915001	016140	TX 45	35	1 ³ / ₈ "	-		10
05066920001	016157	TX 50	35	1 ³ / ₈ "	-		10
05066941001	104007	TX 50	50	2"	-		10
05066950001	104526	TX 50	70	2 ³ / ₄ "	-		10
05066925001	016164	TX 55	35	1 ³ / ₈ "	12,0		10

867/12 TORX® bits

Thread drive M 5.

867/12 TORX® bits

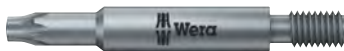

	EAN						
Code	4013288		mm		mm		
05064155001	026484	TX 20	45	1 ³ / ₄ "	6,0		10

867/15 TORX® bits

Thread drive M 6.

867/15 TORX® bits



	EAN						
Code	4013288		mm		mm		
05064170001	032607	TX 20	45	1 ³ / ₄ "	8,0		10
05064175001	032980	TX 25	45	1 ³ / ₄ "	8,0		10

867/9 C TORX® bits, halfmoon

Drive: 4 mm halfmoon for direct power tool connection.

867/9 C TORX® bits, halfmoon



	EAN						
Code	4013288		mm		mm		
05135220001	112637	TX 1	44	1 ⁴⁷ / ₆₄ "	1,5		10
05135221001	112644	TX 2	44	1 ⁴⁷ / ₆₄ "	1,5		10
05135222001	112651	TX 3	44	1 ⁴⁷ / ₆₄ "	1,7		10
05345352001	113597	TX 4	44	1 ⁴⁷ / ₆₄ "	1,8		10
05345018001	113504	TX 4	64	2 ³³ / ₆₄ "	2,0		10
05200496001	214881	TX 5	44	1 ⁴⁷ / ₆₄ "	1,6		10
05345351001	113580	TX 5	44	1 ⁴⁷ / ₆₄ "	3,0		10
05345032001	113542	TX 5	64	2 ³³ / ₆₄ "	2,0		10
05345350001	113573	TX 6	44	1 ⁴⁷ / ₆₄ "	3,0		10
05345056001	113566	TX 6	64	2 ³³ / ₆₄ "	2,0		10
05332610001	035868	TX 6	70	2 ³ / ₄ "	3,0		10
05345035001	113559	TX 7	64	2 ³³ / ₆₄ "	2,3		10
05345026001	113528	TX 8	44	1 ⁴⁷ / ₆₄ "	3,0		10
05345028001	113535	TX 8	64	2 ³³ / ₆₄ "	3,0		10
05332609001	035714	TX 8	70	2 ³ / ₄ "	3,0		10
05332607001	037107	TX 10	70	2 ³ / ₄ "	3,0		10

867/1 Z TORX® BO bits with bore hole

The bore hole in the bit and the pin in the TORX® BO screw prevent any unauthorised loosening – secure fastening.

Tough viscous for universal use. ¹/₄" hexagon, suitable for holders as per DIN ISO 1173-D 6.3.

867/1 Z TORX® BO bits with bore hole



	EAN						
Code	4013288		mm				
05066497001	015822	TX 7	25	1"			10
05066498001	015839	TX 8	25	1"			10
05066499001	015846	TX 9	25	1"			10
05066500001	015853	TX 10	25	1"			10
05066505001	015860	TX 15	25	1"			10
05066510001	015877	TX 20	25	1"			10
05066515001	015884	TX 25	25	1"			10
05066520001	015891	TX 27	25	1"			10
05066525001	015907	TX 30	25	1"			10
05066530001	015914	TX 40	25	1"			10



867/1 Z TORX® BO bits with bore hole SB



Code	EAN			
	4013288			
05073064001	202666		867/1 Z TORX® BO 2x TX 20x25	5
05073065001	202673		867/1 Z TORX® BO 2x TX 25x25	5
05073066001	202680		867/1 Z TORX® BO 2x TX 30x25	5

3867/4 TORX® BO bits with bore hole, stainless

Wera stainless steel bits prevent the formation of unsightly extraneous rust. 1/4" hexagon, suitable for holders as per DIN ISO 1173-F 6.3.

3867/4 TORX® BO bits with bore hole, stainless



Code	EAN						
	4013288		mm		mm		
05071089001	115546	TX 10	89	3 1/2"	4,0		10
05071090001	115553	TX 15	89	3 1/2"	4,0		10
05071091001	115560	TX 20	89	3 1/2"	4,5		10
05071092001	115577	TX 25	89	3 1/2"	5,5		10
05071094001	115584	TX 30	89	3 1/2"	6,0		10

867/4 Z TORX® BO Take it easy bits with hole

Premium bits for TORX® socket screws. TORX® BO screws have a protruding pin in their drive profile. This prevents unauthorized loosening, as these screws cannot be operated with "normal" TORX® tools.

Only special TORX® BO tools have a bore which can mount the pin. Tough, for universal use. 1/4" hexagonal, suitable for holders as per DIN ISO 1173-F 6.3.

- Take it easy tool finder: colour coding according to profile and size

867/4 Z TORX® BO Take it easy bits with hole



Code	EAN						
	4013288		mm		mm		
05059568001	226495	TX 10	89	3 1/2"	4,0		5
05059569001	226501	TX 15	89	3 1/2"	4,0		5
05059570001	226518	TX 20	89	3 1/2"	4,5		5
05059571001	226525	TX 25	89	3 1/2"	6,0		5
05059572001	226532	TX 30	89	3 1/2"	6,0		5

867/4 Z TORX® BO bits with bore hole

Tough viscous for universal use. 1/4" hexagon, suitable for holders as per DIN ISO 1173-D F.3.

867/4 Z TORX® BO bits with bore hole



Code	EAN						
	4013288		mm		mm		
05060139001	030733	TX 8	70	2 3/4"	3,0		10
05060048001	094513	TX 8	89	3 1/2"	3,0		10
05060049001	094520	TX 9	89	3 1/2"	3,0		10
05060140001	026897	TX 10	70	2 3/4"	4,0		10
05060050001	094537	TX 10	89	3 1/2"	4,0		5
05060141001	030740	TX 15	70	2 3/4"	4,0		10
05060051001	094544	TX 15	89	3 1/2"	4,0		5
05060142001	026903	TX 20	70	2 3/4"	4,5		10
05060052001	094551	TX 20	89	3 1/2"	4,5		5
05060143001	026910	TX 25	70	2 3/4"	6,0		10
05060053001	094568	TX 25	89	3 1/2"	6,0		10
05060144001	026927	TX 27	70	2 3/4"	6,0		10
05060057001	094643	TX 27	89	3 1/2"	6,0		5
05060145001	026934	TX 30	70	2 3/4"	6,0		10
05060054001	094575	TX 30	89	3 1/2"	6,0		5
05060146001	026941	TX 40	70	2 3/4"	-		10
05060056001	094582	TX 40	89	3 1/2"	-		5

867/4 Z TORX® B0 bits with bore hole SB



Code	EAN			
	4013288			
05073070001	202604		867/4 Z TORX® B0 2x TX 20x70	5
05073071001	202611		867/4 Z TORX® B0 2x TX 25x70	5
05073072001	202628		867/4 Z TORX® B0 2x TX 30x70	5
05073073001	202574		867/4 Z TORX® B0 2x TX 40x70	5

867/1 IP TORX PLUS® bits

High quality bits for recessed TORX PLUS® screws. TORX PLUS® profile: in comparison to normal TORX® profiles, the enlargement of the 6 torque-transferring flanks between the tool and the screw is effected by means of an ellipse-shaped profile design and not a circular one.

This means that the power applied when screwdriving is spread over a larger area. Higher torque is transferred and the service life of the screw and tool is also enhanced. Tough viscous. 1/4" hexagon, suitable for holders as per DIN ISO 1173-D 6.3.

867/1 IP TORX PLUS® bits



Code	EAN							
	4013288		mm					
05135120001	112606	1 IP	25	1"				10
05135121001	112613	2 IP	25	1"				10
05160956001	113313	3 IP	25	1"				10
05134695001	103109	4 IP	25	1"				10
05066272001	035684	5 IP	25	1"				10
05066274001	031556	6 IP	25	1"				10
05066276001	031563	7 IP	25	1"				10
05066278001	031570	8 IP	25	1"				10
05066279001	033635	9 IP	25	1"				10
05066280001	031549	10 IP	25	1"				10
05066282001	031587	15 IP	25	1"				10
05066284001	031594	20 IP	25	1"				10
05066286001	031600	25 IP	25	1"				10
05066287001	031617	27 IP	25	1"				10
05066288001	031624	30 IP	25	1"				10
05066290001	031631	40 IP	25	1"				10

867/4 IP TORX PLUS® bits



Code	EAN							
	4013288		mm		mm			
05134664001	112514	1 IP	50	2"	2,0			10
05134665001	112521	2 IP	50	2"	2,0			10
05134668001	106568	3 IP	50	2"	2,0			10
05134691001	103093	4 IP	50	2"	3,0			10
05134678001	098030	5 IP	50	2"	3,0			10
05134680001	037220	6 IP	50	2"	3,0			10
05134667001	095596	6 IP	89	3 1/2"	3,0			10
05134690001	095602	6 IP	152	6"	3,0			10
05134681001	037237	7 IP	50	2"	3,0			10
05134679001	037190	8 IP	50	2"	3,0			10
05134670001	032812	8 IP	89	3 1/2"	3,0			10
05134682001	037244	8 IP	152	6"	3,0			10
05160917001	038951	9 IP	50	2"	3,0			10
05134669001	033871	9 IP	89	3 1/2"	3,0			10
05134683001	037251	10 IP	50	2"	4,0			10
05134684001	037268	10 IP	70	2 3/4"	4,0			10
05134671001	032829	10 IP	89	3 1/2"	4,0			10
05134685001	037275	15 IP	50	2"	4,0			10
05134686001	037282	15 IP	70	2 3/4"	4,0			10
05134672001	032836	15 IP	89	3 1/2"	4,0			10
05134687001	037299	20 IP	50	2"	4,5			10
05134688001	037305	20 IP	70	2 3/4"	4,5			10
05134673001	032843	20 IP	89	3 1/2"	4,5			10
05134609001	224767	25 IP	50	2"	6,0			10
05134674001	032850	25 IP	89	3 1/2"	6,0			10
05134675001	032867	27 IP	89	3 1/2"	6,0			10
05320430001	113382	30 IP	50	2"	6,0			10
05134676001	032874	30 IP	89	3 1/2"	6,0			10
05134677001	032881	40 IP	89	3 1/2"	-			10

867/9 C IP TORX PLUS® bits, halfmoon

Drive: 4 mm halfmoon for direct power tool connection.

867/9 C IP TORX PLUS® bits, halfmoon



Code	EAN							
	4013288		mm		mm	mm		
05135230001	112668	1 IP	44	1 47/64"	1,5	20	25/32"	10
05135231001	112675	2 IP	44	1 47/64"	1,5	20	25/32"	10
05135232001	112682	3 IP	44	1 47/64"	1,7	20	25/32"	10
05326310001	113399	4 IP	44	1 47/64"	2,0	20	25/32"	10
05345019001	113511	4 IP	64	2 33/64"	2,0	20	25/32"	10
05135233001	112699	5 IP	44	1 47/64"	2,0	20	25/32"	10
05344900001	113498	6 IP	44	1 47/64"	2,25	20	25/32"	10
05135234001	112705	8 IP	44	1 47/64"	3,0	20	25/32"	10
05332606001	037091	8 IP	70	2 3/4"	3,0	20	25/32"	10
05135235001	112712	10 IP	44	1 47/64"	3,0	20	25/32"	10



IPR TORX PLUS®

A 5-flank TORX PLUS® profile with a borehole.

This drive geometry has only five flanks instead of the usual six and a borehole to protect safety screws against unauthorised unfastening. The screws cannot be turned with conventional, widely available tools.

867/1 IPR TORX PLUS® bits with bore hole



Code	EAN		⌀	ℓ	ℓ				
			mm						
05134699001	034878		8 IPR	25	1"				10
05134698001	037817		9 IPR	25	1"				10
05134700001	034823		10 IPR	25	1"				10
05134701001	034724		15 IPR	25	1"				10
05134702001	034731		20 IPR	25	1"				10
05134703001	034748		25 IPR	25	1"				10
05134704001	034847		27 IPR	25	1"				10
05134705001	034830		30 IPR	25	1"				10
05134706001	034854		40 IPR	35	1 3/8"				10
05134707001	034861		45 IPR	35	1 3/8"				10

867/4 IPR TORX PLUS® bits with bore hole

High quality bits for recessed TORX PLUS® screws. A 5-flank TORX PLUS® profile. 1/4" hexagon, suitable for holders as per DIN ISO 1173-F 6.3.

867/4 IPR TORX PLUS® bits with bore hole



Code	EAN		⌀	ℓ	ℓ	∅			
			mm			mm			
05160821001	160867		10 IPR	50	2"	4,0			10
05134657001	155665		10 IPR	89	3 1/2"	4,0			10
05134654001	155641		15 IPR	50	2"	4,0			10
05134720001	037206		15 IPR	89	3 1/2"	4,0			10
05204126001	160874		20 IPR	50	2"	4,5			10
05259135001	160881		20 IPR	89	3 1/2"	4,5			10
05134655001	155658		25 IPR	50	2"	6,0			10
05134722001	160904		25 IPR	89	3 1/2"	6,0			10
05134656001	156952		27 IPR	50	2"	6,0			10
05134658001	155672		27 IPR	89	3 1/2"	6,0			10
05134732001	160911		30 IPR	50	2"	6,0			10
05134723001	160935		30 IPR	89	3 1/2"	6,0			10

BiTorsion system - for longer service life



800/1 BDC bits

Bits with tiny diamond particles on the bit tip. This ensures a secure fit of the bit in the screw, reduces the contact pressure required and lowers the risk of slipping.

Comes with Torsion zone – where kinetic energy is diverted from peak loads – and softer BiTorsion zone to prevent the bit tip from twisting under peak loads. This greatly extends the product service life; 1/4" hexagon, suitable for holders as per DIN ISO 1173-D 6.3.

800/1 BDC bits



Code	EAN	ℓ	ℓ	ℓ	ℓ				
		mm	mm	mm	mm				
05056172001	033949	0,8	5,5	25	1"				10
05056174001	033956	1,0	5,5	25	1"				10
05056176001	033963	1,2	6,5	25	1"				10

800/1 BTZ bits

Comes with Torsion zone – where kinetic energy is diverted from peak loads – and softer BiTorsion zone to prevent the bit tip from twisting under peak loads.

This greatly extends the product service life. Tough viscous, for universal use; 1/4" inch hexagon, suitable for holders as per DIN ISO 1173-D 6.3.

800/1 BTZ bits



Code	EAN	mm	mm	mm	mm	mm	mm	mm
05056064001	034427	0,8	5,5	25	1"			10
05056066001	034434	1,0	5,5	25	1"			10
05056068001	034441	1,2	6,5	25	1"			10

800/1 TZ bits

Bits with Torsion zone to combat premature wear.

Tough viscous for universal use; 1/4" hexagon, suitable for holders as per DIN ISO 1173-D 6.3.

800/1 TZ bits



Code	EAN	mm	mm	mm	mm	mm	mm	mm
05056203001	011145	0,5	4,0	25	1"	4,0		10
05056210001	011152	0,6	4,5	25	1"	4,5		10
05056220001	011169	0,8	5,5	25	1"	5,5		10
05056225001	011176	1,0	5,5	25	1"	5,5		10
05056233001	011183	1,2	6,5	25	1"	6,2		10
05056240001	011190	1,6	8,0	25	1"	8,0		10

800/1 Z bits

Tough viscous Wera bits for universal use. 1/4" hexagon, suitable for holders as per DIN ISO 1173-D 6.3.

800/1 Z bits



Code	EAN	mm	mm	mm	mm	mm	mm	mm
05056200001	040831	0,5	3,0	25	1"	3,0		10
05072050001	030467	0,5	4,0	25	1"	4,0		10
05072055001	010933	0,6	4,5	25	1"	4,5		10
05072057001	010940	0,8	5,5	25	1"	5,5		10
05072059001	010957	1,0	5,5	25	1"	5,5		10
05072061001	010964	1,2	6,5	25	1"	6,2		10
05072063001	030450	1,2	8,0	25	1"	8,0		10
05072065001	010971	1,6	8,0	25	1"	8,0		10

Kraftform Stainless - stainless steel to prevent rust



High quality stainless steel bits for slotted screws. Made out of stainless steel which prevents the formation of unsightly extraneous rust. 1/4" hexagon, suitable for holders as per DIN ISO 1173-F 6.3.



3800/4 Bits, stainless



Code	EAN	mm	mm	mm	mm	mm	mm	mm
05071080001	115669	1,0	5,5	89	3 1/2"			10

800/4 Z Take it easy bits

Tough Wera bits for slotted screws, for universal use.
 1/4" hexagonal, suitable for holders as per DIN ISO 1173-F 6.3.

- Take it easy tool finder: colour coding according to profile and size

800/4 Z Take it easy bits



	EAN							
Code	4013288	mm	mm	mm	mm	mm	mm	
05059560001	226419	1,0	5,5	89	2"	5,5		10

800/4 Z bits

Tough viscous Wera bits for universal use. 1/4" hexagon, suitable for holders as per DIN ISO 1173-F 6.3.

800/4 Z bits



	EAN							
Code	4013288	mm	mm	mm	mm	mm	mm	
05059305001	011480	0,5	3,0	50	2"	3,0		10
05059466001	011497	0,5	3,0	70	2 3/4"	3,0		10
05059307001	011503	0,5	4,0	50	2"	4,0		10
05059310001	011510	0,6	3,5	50	2"	3,5		10
05059472001	011527	0,6	3,5	70	2 3/4"	3,5		10
05059450001	031471	0,6	3,5	152	6"	3,5		10
05059315001	011534	0,6	4,5	50	2"	4,5		10
05059489001	094230	0,6	4,5	89	3 1/2"	4,5		10
05059320001	011541	0,8	4,0	50	2"	4,0		10
05059478001	011558	0,8	4,0	70	2 3/4"	4,0		10
05059480001	011565	0,8	4,0	89	3 1/2"	4,0		10
05059451001	031389	0,8	4,0	152	6"	4,0		10
05059325001	011572	0,8	5,5	50	2"	5,5		10
05059330001	011589	1,0	5,5	50	2"	5,5		10
05059486001	011596	1,0	5,5	70	2 3/4"	5,5		10
05059488001	011602	1,0	5,5	89	3 1/2"	5,5		10
05059452001	031235	1,0	5,5	152	6"	5,5		10
05059335001	035004	1,0	6,0	50	2"	6,0		10
05059337001	011619	1,2	6,5	50	2"	6,2		10
05059492001	011626	1,2	6,5	70	2 3/4"	6,2		10
05059490001	094247	1,2	6,5	89	3 1/2"	6,2		10
05059453001	031488	1,2	6,5	152	6"	6,2		10
05059340001	011633	1,2	8,0	50	2"	8,0		10
05059496001	011640	1,2	8,0	89	3 1/2"	8,0		10
05059345001	011657	1,6	8,0	50	2"	8,0		10
05059500001	011664	1,6	8,0	89	3 1/2"	8,0		10

800/9 C bits

Hard bits against premature breakage.
 Drive: halfmoon, 4 mm.

800/9 C bits



	EAN							
Code	4013288	mm	mm	mm	mm	mm	mm	
05135265001	168276	0,23	1,5	44	1 47/64"	1,5		10
05135264001	194770	0,35	2,5	44	1 47/64"	2,5		10
05135266001	168283	0,40	2,0	44	1 47/64"	2,0		10
05135267001	168290	0,50	3,0	44	1 47/64"	3,0		10

800/2 Z bits

5/16" hexagon, suitable for holders as per DIN ISO 1173-D 8.

800/2 Z bits



	EAN							
Code	4013288	mm	mm	mm	mm	mm	mm	
05057225001	011275	1,2	8,0	41	1 19/32"	7,8		10
05057235001	011299	1,6	10,0	41	1 19/32"	7,8		10
05057240001	011305	2,0	12,0	41	1 19/32"	12,0		10

Impaktor system - For an above-average service life



High quality Impaktor bits for hexagon socket screws. The Impaktor technology offers an above-average service life even under extreme circumstances.

Enhanced friction resistance, thanks to the rough diamond-particle coating on the bit tip, prevents any slipping out of the screw head. Hex-Plus ensures a greater contact surface in the head of the screw.

The notching effect is therefore reduced to a minimum and damage to the screw head more or less eliminated. 1/4" hexagon, suitable for holders as per DIN ISO 1173-D 6.3.

840/1 IMP DC Hex-Plus DIY Impaktor bits



Code	EAN			
	4013288			
05057603001	178701	○	840/1 IMP DC 10x 3.0x25	1
05057604001	157560	○	840/1 IMP DC 10x 4.0x25	1
05057605001	157423	○	840/1 IMP DC 10x 5.0x25	1
05057606001	157430	○	840/4 IMP DC 10x 6.0x25	1

840/1 IMP DC SB Impaktor bits



Code	EAN			
	4013288			
05073904001	158338	○	840/1 IMP DC 1x 4.0x25	5
05073905001	158345	○	840/1 IMP DC 1x 5.0x25	5
05073906001	158352	○	840/1 IMP DC 1x 6.0x25	5

Kraftform Stainless - stainless steel to prevent rust



High quality bits out of stainless steel for hexagon socket screws. Prevents the formation of unsightly extraneous rust.

The Hex-Plus profile offers a greater contact surface in the head of the screw. The notching effect is therefore reduced to a minimum and damage to the screw head more or less eliminated.

Come with Torsion zone: Torsion bits take-up torque peaks and absorb them in the Torsion zone. This prevents premature wear and extends the service life of the bit. 1/4" hexagon, suitable for holders as per DIN ISO 1173-D 6.3.

3840/1 TS bits, stainless



Code	EAN	mm	mm	mm	mm		
05071070001	111197	1,5	25	1"			10
05071071001	111203	2,0	25	1"			10
05071072001	111210	2,5	25	1"			10
05071073001	111227	3,0	25	1"			10
05071074001	111234	4,0	25	1"			10
05071075001	111241	5,0	25	1"			10
05071077001	115478	5,5	25	1"			10
05071076001	111258	6,0	25	1"			10



840/1 Z Sets SB



Code	EAN			
	4013288			
05073050001	202567		840/1 Z Hex-Plus 2x 2.0x25	5
05073051001	202550		840/1 Z Hex-Plus 2x 2.5x25	5
05073052001	202512		840/1 Z Hex-Plus 2x 3.0x25	5
05073053001	202529		840/1 Z Hex-Plus 2x 4.0x25	5
05073054001	202536		840/1 Z Hex-Plus 2x 5.0x25	5
05073055001	202543		840/1 Z Hex-Plus 2x 6.0x25	5
05073342001	029607		840/1 Z Hex-Plus 1x 2.0x25; 1x 2.5x25; 1x 3.0x25	5
05073344001	029614		840/1 Z Hex-Plus 1x 4.0x25; 1x 5.0x25; 1x 6.0x25	5

842/1 Z bits

The ballpoint drive profile means that it is possible to swivel the tool axis away from the screwdriving axis, thus enabling „round the corner“ screwdriving.

1/4" hexagon, suitable for holders as per DIN ISO 1173-D 6.3.

842/1 Z bits



Code	EAN			mm	mm			
	4013288							
05056350001	013156	2,5		25	1"			10
05056352001	013163	3,0		25	1"			10
05056354001	013170	4,0		25	1"			10
05056356001	013187	5,0		25	1"			10
05056358001	013194	6,0		25	1"			10

Impaktor system - For an above-average service life



High quality Impaktor bits for hexagonal socket screws. The Impaktor technology offers an above-average service life even under extreme circumstances.

Enhanced friction resistance, thanks to the rough diamond-particle coating on the bit tip, prevents any slipping out of the screw head.

Hex-Plus ensures a greater contact surface in the head of the screw. The notching effect is therefore reduced to a minimum and damage to the screw head more or less eliminated.

1/4" hexagon, suitable for holders as per DIN ISO 1173-F 6.3.

840/4 IMP DC Hex-Plus DIY Impaktor bits



Code	EAN			
	4013288			
05057644001	157577		840/4 IMP DC 5x 4.0x50	1
05057645001	157492		840/4 IMP DC 5x 5.0x50	1
05057646001	157508		840/4 IMP DC 5x 6.0x50	1



840/4 IMP DC Impaktor bits SB



Code	EAN			
	4013288			
05073944001	158451		840/4 IMP DC 1x 4.0x50	5
05073945001	158468		840/4 IMP DC 1x 5.0x50	5
05073946001	158475		840/4 IMP DC 1x 6.0x50	5

Krafform Stainless - stainless steel to prevent rust



Wera stainless steel bits prevent the formation of unsightly extraneous rust. The Hex-Plus profile offers a greater contact surface in the head of the screw.

The notching effect is therefore reduced to a minimum and damage to the screw head more or less eliminated. 1/4" hexagon, suitable for holders as per DIN ISO 1173-F 6.3.

3840/4 Bits, stainless



	EAN						
Code	4013288	mm		mm			
05071101001	115621	3,0		89	3 1/2"		10
05071102001	115638	4,0		89	3 1/2"		10
05071103001	115645	5,0		89	3 1/2"		10
05071104001	115652	6,0		89	3 1/2"		10
05071105001	115676		3/32"	89	3 1/2"		10
05071106001	115683		1/8"	89	3 1/2"		10
05071107001	115690		5/32"	89	3 1/2"		10
05071108001	115706		3/16"	89	3 1/2"		10

Hex-Plus - lets hexagon socket screws last longer

Deformation of the screws is reduced

Above-average service life



840/4 Z Take it easy bits

- Take it easy tool finder: colour coding according to profile and size

840/4 Z Take it easy bits



	EAN						
Code	4013288	mm	mm		mm		
05059561001	226426	3,0	89	3 1/2"	4,0		5
05059562001	226433	4,0	89	3 1/2"	5,0		5
05059563001	226440	5,0	89	3 1/2"	6,0		5

840/4 Z bits



	EAN	Ø	Ø	L	L	Ø	
Code	4013288	mm		mm		mm	
05160885001	200976	0,9		50	2"	2,6	10
05059602001	112408	1,5		50	2"	2,0	10
05059603001	034694	2,0		50	2"	4,0	10
05059628001	155450	2,0		89	3 1/2"	4,0	5
05059604001	034700	2,5		50	2"	4,0	10
05059629001	155467	2,5		89	3 1/2"	4,0	5
05059605001	012906	3,0		50	2"	4,0	10
05059630001	094254	3,0		89	3 1/2"	4,0	5
05380033001	156433	3,0		152	6"	4,0	5
05059610001	012913	4,0		50	2"	5,0	10
05059631001	094261	4,0		89	3 1/2"	5,0	5
05059634001	122964	4,0		152	6"	5,0	5
05059615001	012920	5,0		50	2"	6,0	10
05059632001	094278	5,0		89	3 1/2"	6,0	5
05059635001	122971	5,0		152	6"	6,0	5
05059620001	012937	6,0		50	2"	5,0	10
05059633001	094285	6,0		89	3 1/2"	-	5
05059636001	122988	6,0		152	6"	-	5
05059625001	012944	8,0		50	2"	-	10
05059637001	215031	8,0		89	3 1/2"	-	5
05350430001	161406		0,05"	50	2"	2,5	10
05135090001	107053		1/16"	50	2"	2,5	10
05380045001	156730		1/8"	152	6"	4,0	5
05135091001	036414		5/64"	50	2"	3,0	10
05059660001	155474		5/64"	89	3 1/2"	3,0	5
05135092001	036421		3/32"	50	2"	3,0	10
05059661001	155481		3/32"	89	3 1/2"	3,5	5
05135093001	036438		7/64"	50	2"	3,5	10
05059662001	155498		7/64"	89	3 1/2"	4,0	5
05135094001	036445		1/8"	50	2"	4,0	10
05059663001	155504		1/8"	89	3 1/2"	4,0	5
05135095001	036377		9/64"	50	2"	4,5	10
05059664001	155511		9/64"	89	3 1/2"	4,5	5
05380046001	156822		9/64"	152	6"	4,5	5
05135096001	036384		5/32"	50	2"	5,0	10
05059665001	155528		5/32"	89	3 1/2"	5,0	5
05380047001	156839		5/32"	152	6"	5,0	5
05135097001	036391		3/16"	50	2"	6,0	10
05059666001	155535		3/16"	89	3 1/2"	6,0	5
05380048001	156846		3/16"	152	6"	6,0	5
05135098001	036407		7/32"	50	2"	-	10
05059667001	155542		7/32"	89	3 1/2"	-	5
05380049001	156853		7/32"	152	6"	-	5
05135099001	095589		1/4"	50	2"	-	10
05059668001	155559		1/4"	89	3 1/2"	-	5
05380050001	156860		1/4"	152	6"	-	5
05346288001	103895		5/16"	50	2"	-	10

840/4 Z SB bits



Code	EAN			
	4013288			
05073056001	202468	⊙	840/4 Z Hex-Plus 2x 2.0x50	3
05073057001	202475	⊙	840/4 Z Hex-Plus 2x 2.5x50	3
05073058001	202482	⊙	840/4 Z Hex-Plus 2x 3.0x50	3
05136301001	213792	⊙	840/4 Z Hex-Plus 1x 3.0x152	3
05073059001	202499	⊙	840/4 Z Hex-Plus 2x 4.0x50	3
05136302001	213808	⊙	840/4 Z Hex-Plus 1x 4.0x152	3
05073060001	202505	⊙	840/4 Z Hex-Plus 2x 5.0x50	3
05136303001	213815	⊙	840/4 Z Hex-Plus 1x 5.0x152	3
05073061001	202444	⊙	840/4 Z Hex-Plus 2x 6.0x50	3
05136304001	213822	⊙	840/4 Z Hex-Plus 1x 6.0x152	3

840/4 Ni Bits

- Chemically nickel-plated

840/4 Ni Bits



	EAN	Ø	L	L			
Code	4013288	mm	mm				
05059573001	226600	6,0	89	3 1/2"			5



842/4 Bits

The ballpoint drive profile means that it is possible to swivel the tool axis away from the screwdriving axis, thus enabling „round the corner“ screwdriving. 1/4" hexagon, suitable for holders as per DIN ISO 1173-F 6.3.

842/4 Bits



	EAN	⊘	⊘	⏏	⏏			
Code	4013288	mm		mm				
05059680001	155931	3,0		89	3 1/2"			5
05059681001	155948	4,0		89	3 1/2"			5
05059682001	155955	5,0		89	3 1/2"			5
05059683001	155962	6,0		89	3 1/2"			5
05380124001	156587		3/32"	89	3 1/2"			5
05380125001	156594		7/64"	89	3 1/2"			5
05380126001	156600		1/8"	89	3 1/2"			5
05380127001	156617		9/64"	89	3 1/2"			5
05380128001	156624		5/32"	89	3 1/2"			5
05380129001	156631		3/16"	89	3 1/2"			5
05380130001	156648		7/32"	89	3 1/2"			5
05380131001	156655		1/4"	89	3 1/2"			5

840/2 Z Bits

Tough viscous Wera bits for hexagon socket screws for universal use. Hex-Plus offers a greater contact surface in the head of the screw. The notching effect is therefore reduced to a minimum and damage to the screw head more or less eliminated. 5/16" hexagon, suitable for holders as per DIN ISO 1173-D 8.

840/2 Z Bits



	EAN	⊘	⊘	⏏	⏏			
Code	4013288	mm		mm				
05057505001	012753	3		30	1 3/16"			10
05057510001	012760	4		30	1 3/16"			10
05057515001	012777	5		30	1 3/16"			10
05057520001	012784	6		30	1 3/16"			10
05057525001	012791	8		30	1 3/16"			10
05057530001	012807	10		30	1 3/16"			10

840/9 C Bits

Drive: 4 mm halfmoon for direct power tool connection.

840/9 C Bits



	EAN	⊘	⏏	⏏	∅			
Code	4013288	mm	mm		mm			
05135268001	168306	1,5	44	1 47/64"	2,6			10
05135269001	168313	2,0	44	1 47/64"	2,6			10

840/1 Z Tamper-proof Hex-Plus B0 bits

Hexagon socket B0 screws have a protruding pin in their drive profile.

This prevents any unauthorised loosening since the "normal" hex tools cannot move these screws. 1/4" hexagon, suitable for holders as per DIN ISO 1173-D 6.3.

840/1 Z Tamper-proof Hex-Plus B0 bits



	EAN	⊘	⏏	⏏				
Code	4013288	mm	mm					
05056341001	038548	2,0	25	1"				10
05056342001	038555	2,5	25	1"				10
05056343001	038562	3,0	25	1"				10
05056344001	038593	4,0	25	1"				10
05056345001	038579	5,0	25	1"				10
05056346001	038586	6,0	25	1"				10

840/4 Z Tamper-proof Hex-Plus B0 bits

1/4" hexagon, suitable for holders as per DIN ISO 1173-F 6.3.

840/4 Z Tamper-proof Hex-Plus B0 bits



	EAN						
Code		mm	mm	mm	mm		
05059640001	094292	2,0	89	3 1/2"	4,0		5
05059641001	094308	2,5	89	3 1/2"	4,0		5
05059642001	094315	3,0	89	3 1/2"	4,0		5
05059643001	094322	4,0	89	3 1/2"	5,0		5
05059644001	094339	5,0	89	3 1/2"	6,0		5
05059645001	094346	6,0	89	3 1/2"	-		5

9506 SB 4-in-1 Bit 1

Four different screw profiles (hexagonal socket screws sizes 3.0; 4.0; 5.0; 6.0) can be operated with only one bit. Significant weight savings of over 50 %.

The operability of the large profiles is made possible by the spring compression of the small tips.

The bit has a 1/4" hexagon drive (Wera connection series 1) and can therefore also be used with e.g. bit ratchets and bitholding screwdrivers with Rapidaptor.

- Innovative, extremely compact quadruple bit – only one bit for four different screw sizes
- Suitable for hexagonal socket screws sizes 3.0; 4.0; 5.0 and 6.0
- Tough for hard materials
- 1/4" hexagon drive (Wera connecting series 1)

9506 SB 4-in-1 Bit 1



Code	EAN					
05073201001	225269					1
			9506		1x 3,0; 4,0; 5,0; 6,0x37	

9507 SB 4-in-1 Bit 2

Four different screw profiles (hexagonal socket screws sizes 2.5; 5.0; 6.0 and TORX® screws size TX 25) can be operated with just one bit.

The enormous space savings make the bit perfect for mobile use. Significant weight savings of over 50 %. The operability of the large profiles is made possible by the spring compression of the small tips.

The bit with a 1/4" hexagon drive (Wera connection series 1) can also be used with e.g. bit ratchets and bitholding screwdrivers with Rapidaptor.

- Innovative, extremely compact quadruple bit – only one bit for four different screw sizes
- Suitable for hexagonal socket screws sizes 2.5; 5.0; 6.0 and TORX® screws TX 25
- Tough for hard materials
- 1/4" hexagon drive (Wera connecting series 1)

9507 SB 4-in-1 Bit 2



Code	EAN					
05073202001	225276					1
			9507		1x 2,5; 5,0; 6,0; TX 25x37	



Impaktor system - For an above-average service life



High quality bits for square socket screws. The Impaktor technology offers an above-average service life even under extreme circumstances.

Enhanced friction resistance, thanks to the rough diamond-particle coating on the bit tip, prevents any slipping out of the screw head. Particularly suitable for use with customary impact drivers. 1/4" hexagon, suitable for holders as per DIN ISO 1173-D 6.3.

868/1 IMP DC DIY Impaktor square head socket bits



Code	EAN		
05057631001	157478	868/1 IMP DC 10x # 2x25	1
05057632001	157485	868/1 IMP DC 10x # 3x25	1

868/1 IMP DC SB Impaktor Square-Plus bits



Code	EAN		
05073931001	158437	868/1 IMP DC 1x # 2x25	5
05073932001	158444	868/1 IMP DC 1x # 3x25	5

868/1 V Square-Plus bits

High quality bits for square socket screws with wedging function.

The wedging forces resulting from the contact pressure between the drive tip and the screw profile securely hold the screw on the tool. 1/4" hexagon, suitable for holders as per DIN ISO 1173-D 6.3.

868/1 V Square-Plus bits



Code	EAN	□	⌈	⌋	⊘		
	4013288		mm		mm		
05340245001	118202	# 1	25	1"	6,1		10
05066394001	113603	# 2	25	1"	6,1		10
05066396001	169228	# 3	25	1"	6,1		10

Bit-Box 20 V Robertson



Code	EAN		
05057790001	188083	868/1 V 20x # 2x25	20

868/1 Z Square-Plus bits

High quality bits for square socket screws. Tough viscous for universal use. 1/4" hexagon, suitable for holders as per DIN ISO 1173-D 6.3.

868/1 Z Square-Plus bits



	EAN						
Code	4013288		mm		mm		
05066395001	030214	# 00	25	1"	3,5		10
05066400001	030221	# 0	25	1"	3,5		10
05066405001	030207	# 1	25	1"	4,5		10
05066410001	030238	# 2	25	1"	6,0		10
05066415001	030245	# 3	25	1"	6,0		10
05066420001	030252	# 4	25	1"	8,0		10

868/1 Z SB Square-Plus bits



	EAN				
Code	4013288				
05073074001	202727		868/1 Z 2x # 1x25		5
05073075001	202710		868/1 Z 2x # 2x25		5

Impaktor system - For an above-average service life



High quality bits for square socket screws. The Impaktor technology offers an above-average service life even under extreme circumstances.

Enhanced friction resistance, thanks to the rough diamond-particle coating on the bit tip, prevents any slipping out of the screw head. Particularly suitable for use with customary impact drivers. 1/4" hexagon, suitable for holders as per DIN ISO 1173-F 6.3.

868/4 IMP DC DIY Impaktor square head socket bits



	EAN			
Code	4013288			
05057671001	157546		868/4 IMP DC 5x # 2x50	1
05057672001	157553		868/4 IMP DC 5x # 3x50	1



868/4 IMP DC SB Impaktor Square-Plus bits



Code	EAN			
	4013288			
05073971001	158550	○	868/4 IMP DC 1x # 2x50	5
05073972001	158567	○	868/4 IMP DC 1x # 3x50	5

Kraftform Stainless - stainless steel to prevent rust



High quality bits out of stainless steel for square socket screws prevent the formation of unsightly extraneous rust. 1/4" hexagon, suitable for holders as per DIN ISO 1173-F 6.3.

3868/4 Square-Plus bits, stainless



Code	EAN	○	┆	┆	∅		
	4013288		mm		mm		
05071097001	115591	# 1	89	3 1/2"	4,5		10
05071098001	115607	# 2	89	3 1/2"	5,0		10
05071099001	115614	# 3	89	3 1/2"	5,5		10

868/4 BTZ Square-Plus bits



Code	EAN	○	┆	┆	∅		
	4013288		mm		mm		
05060147001	041272	#1	50	2"	4,2		10
05060148001	041289	#2	50	2"	4,2		10
05060149001	041296	#3	50	2"	5,5		10

868/4 Square-Plus bits



Code	EAN	○	┆	┆	∅		
	4013288		mm		mm		
05060150001	030269	# 00	50	2"	3,5		10
05060155001	030276	# 0	50	2"	3,5		10
05060160001	030283	# 1	50	2"	4,5		10
05060180001	041043	# 1	70	2 3/4"	4,5		10
05134800001	040930	# 1	89	3 1/2"	4,5		10
05134805001	040923	# 1	152	6"	4,5		10
05060165001	030290	# 2	50	2"	6,0		10
05060182001	041050	# 2	70	2 3/4"	6,0		10
05134801001	040947	# 2	89	3 1/2"	6,0		10
05134806001	040954	# 2	152	6"	6,0		10
05060170001	030306	# 3	50	2"	6,0		10
05060184001	032805	# 3	70	2 3/4"	6,0		10
05134802001	040961	# 3	89	3 1/2"	6,0		10
05134807001	040978	# 3	152	6"	6,0		10
05060175001	030313	# 4	50	2"	8,0		10

868/4 Z SB Square-Plus bits



Code	EAN			
	4013288			
05073076001	202703	○	868/4 Square-Plus 2x # 1x50	5
05073077001	202697	○	868/4 Square-Plus 2x # 2x50	5

868/4 V Square-Plus bits

With wedging function.

868/4 V Square-Plus bits



	EAN						
Code	4013288		mm	mm	mm		
05060300001	169211	# 1	50	2"	4,5		10
05060297001	169198	# 1	89	3 1/2"	4,5		10
05060301001	113610	# 2	50	2"	6,0		10
05060302001	113627	# 2	70	2 3/4"	6,0		10
05060303001	113634	# 2	89	3 1/2"	6,0		10
05060304001	113641	# 2	152	6"	6,0		10
05060296001	169181	# 3	50	2"	6,0		10
05060298001	169204	# 3	89	3 1/2"	6,0		10

Diamond-coated bits

Minute diamond particles on the tip of the tool literally bite into the screw

Bits fit securely into the head of the screw

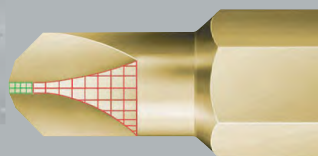

High quality bits with Mplus advantage for more breaking torque and thereby enhanced durability; diamond coating for a secure fit in the screw head.

871/1 DC TORQ-SET® Mplus bits



	EAN						
Code	4013288			mm	mm	mm	
05066638001	099525	4		25	1"	4,7	10
05066640001	033161	6		25	1"	4,7	10
05066642001	033178	8		25	1"	6,0	10
05066644001	033185	10		25	1"	6,0	10
05066646001	033192	--	1/4"	32	1 1/4"	11,0	10

871/1 TORQ-SET® Mplus bits

TORQ-SET® Mplus: The stronger flanks – when compared with the conventional TORQ-SET® profile – result in 70% more breaking torque and thereby enhanced durability whilst at the same time providing a perfect fit in the screw head.

Tough viscous for universal use. 1/4" hexagon, suitable for holders as per DIN ISO 1173-D 6.3.

871/1 TORQ-SET® Mplus bits, 25 mm



	EAN						
Code	4013288			mm	mm	mm	
05066618001	093073	0		25	1"	4,7	10
05066619001	041562	1		25	1"	4,7	10
05066620001	033086	2		25	1"	4,7	10
05066622001	033093	3		25	1"	4,7	10
05066624001	033109	4		25	1"	4,7	10
05066626001	033116	5		25	1"	4,7	10
05066628001	033123	6		25	1"	4,7	10
05066630001	033130	8		25	1"	6,0	10
05066632001	033147	10		25	1"	6,0	10
05066633001	037558	--	1/4"	25	1"	6,0	10

871/1 TORQ-SET® Mplus bits, 32 mm



	EAN						
Code	4013288			mm	mm	mm	
05066634001	033154	1/4"		32	1 1/4"	11,0	10
05066635001	093011	5/16"		32	1 1/4"	11,0	10

871/4 DC TORQ-SET® Mplus bits

High quality bits with Mplus advantage for more breaking torque and thereby enhanced durability; diamond coating for a secure fit in the screw head.

1/4" hexagon, suitable for holders as per DIN ISO 1173-F 6.3.

871/4 DC TORQ-SET® Mplus bits



	EAN						
Code	4013288			mm	mm	mm	
05324901001	162984	2		50	2"		10
05066688001	099532	4		50	2"		10
05066690001	033345	6		50	2"		10
05066692001	033352	8		50	2"		10
05066694001	033369	10		50	2"		10
05066696001	033376	--	1/4"	50	2"		10



871/4 TORQ-SET® Mplus bits



	EAN	+	+	⌈	⌈				
Code	4013288			mm					
0506660001	033239	2		50	2"				10
05066683001	094469	2		89	3 1/2"				5
05066662001	033246	3		50	2"				10
05066684001	094476	3		89	3 1/2"				5
05066664001	033253	4		50	2"				10
05066685001	094483	4		89	3 1/2"				5
05066666001	033260	5		50	2"				10
05066668001	033277	6		50	2"				10
05066676001	033307	6		70	2 3/4"				5
05066686001	094490	6		89	3 1/2"				10
05066670001	033055	8		50	2"				10
05066678001	033314	8		70	2 3/4"				5
05066687001	094506	8		89	3 1/2"				10
05066672001	033284	10		50	2"				10
05066680001	033321	10		70	2 3/4"				5
05066682001	033338	10		89	3 1/2"				5
05066674001	033291	--	1/4"	50	2"				10
05221110001	035851	--	5/16"	50	2"				10

871/2 TORQ-SET® Mplus bits

5/16" hexagon, suitable for holders as per DIN ISO 1173-D 8.

871/2 TORQ-SET® Mplus bits



	EAN	+	+	⌈	⌈				
Code	4013288			mm					
05066654001	033208	--	1/4"	32	1 1/4"				5
05066656001	033215	--	5/16"	32	1 1/4"				5

875/1 TRI-WING® bits, 25 mm

High quality bits for TRI-WING® screws. Tough viscous for universal use. 1/4" hexagon, suitable for holders as per DIN ISO 1173-D 6.3.

875/1 TRI-WING® bits, 25 mm



	EAN	⌈	⌈	⊘					
Code	4013288			mm		mm			
05066758001	093059	0		25	1"	4,7			10
05066760001	033482	1		25	1"	4,7			10
05066762001	033499	2		25	1"	4,7			10
05066764001	033505	3		25	1"	4,7			10
05066766001	033512	4		25	1"	6,2			10
05066768001	033529	5		25	1"	6,2			10

875/4 TRI-WING® bits

Tough viscous for universal use. 1/4" hexagon, suitable for holders as per DIN ISO 1173-F 6.3.

875/4 TRI-WING® bits



	EAN	⌈	⌈	⊘					
Code	4013288			mm					
05066785001	094605	1		89	3 1/2"				5
05066786001	094612	2		89	3 1/2"				5
05066787001	094629	3		89	3 1/2"				5
05066788001	094636	4		89	3 1/2"				5

860/1 XZN Multi-point bits

High quality bits for recessed multi-point screws. Tough viscous for universal use. 1/4" hexagon, suitable for holders as per DIN ISO 1173-D 6.3.

860/1 XZN Multi-point bits



	EAN	⊘	⌈	⌈	⊘				
Code	4013288		mm		mm				
05066150001	034953	M 4	25	1"	4,17				10
05066155001	034960	M 5	25	1"	5,14				10
05066160001	034977	M 6	25	1"	-				10
05066165001	034984	M 8	25	1"	8,0				5
05066170001	034991	M 10	25	1"	10,0				5

872/9 bits for Microstix® screws

With 4 mm halfmoon drive for direct insertion in the power tool.

872/9 bits for Microstix® screws



	EAN	⌈	⌈	⊘	⌈				
Code	4013288			mm	mm				
05066850001	179272	m		44	2,0	1 47/64"			10
05066851001	179296	00		44	2,0	1 47/64"			10
05066852001	179302	F		44	2,0	1 47/64"			10
05066853001	179319	0		44	2,0	1 47/64"			10
05066854001	179326	1		44	2,0	1 47/64"			10

857/1 Z Spanner bits

Bits for spanner screws. Tough viscous for universal use. 1/4" hexagon, suitable for holders as per DIN ISO 1173-D 6.3.

857/1 Z Spanner bits



	EAN						
Code	4013288		mm		mm		
05057150001	038609	4	25	1"	3,18		10
05057151001	038616	6	25	1"	4,32		10
05057152001	038623	8	25	1"	5,21		10
05057153001	038630	10	25	1"	6,10		10

857/4 Z Spanner bits

Tough viscous for universal use. 1/4" hexagon, suitable for holders as per DIN ISO 1173-F 6.3.

857/4 Z Spanner bits



	EAN						
Code	4013288		mm		mm		
05057160001	094810	4	89	3 1/2"	3,18		5
05057161001	094827	6	89	3 1/2"	4,32		5
05057162001	094834	8	89	3 1/2"	5,21		5
05057163001	094841	10	89	3 1/2"	6,10		5

Kraftform Stainless - stainless steel to prevent rust

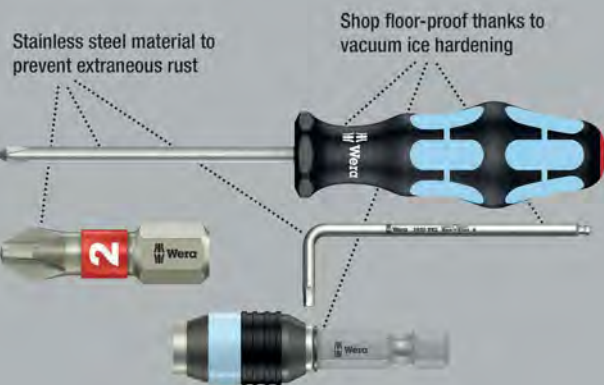

High quality nutsetter out of stainless steel for hexagon head screws. Stainless to prevent the risk of extraneous rust. Non-magnetic design with retaining spring. 1/4" hexagon, suitable for holders as per, DIN ISO 1173-F 6.3.

3869/4 Nutsetters, stainless



	EAN						
Code	4013288	mm		mm	mm		
05071222001	118127	7,0		50,0	12,5		5
05071223001	118257	8,0		50,0	14,0		5
05071224001	118141	10,0		50,0	16,0		5
05071225001	118158	13,0		50,0	19,5		5
05071228001	118189		3/8"	50,0	16,0		5

869/4 Nutsetters

Non-magnetic design. 1/4" hexagon, suitable for holders as per DIN ISO 1173-F 6.3.

869/4 Nutsetters



	EAN						
Code	4013288	mm		mm	mm		
05060400001	100948	5,5		50,0	11,0		5
05060272001	016546	5,5		65,0	9,0		5
05060401001	100955	6,0		50,0	11,0		5
05060274001	016553	6,0		65,0	11,0		5
05060402001	100962	7,0		50,0	11,0		5
05060276001	016560	7,0		65,0	11,0		5
05060403001	100979	8,0		50,0	12,5		5
05060278001	016577	8,0		65,0	12,5		5
05060404001	100986	9,0		50,0	14,0		5
05060280001	016584	9,0		65,0	14,0		5
05060405001	100993	10,0		50,0	14,0		5
05060282001	016591	10,0		65,0	14,0		5
05060406001	101006	11,0		50,0	16,0		5
05060281001	031327	11,0		65,0	16,0		5
05060407001	101013	12,0		50,0	18,0		5
05060283001	031334	12,0		65,0	18,0		5
05060408001	101020	13,0		50,0	18,0		5
05060284001	016607	13,0		65,0	19,0		5
05060409001	101037		1/4"	50,0	11,0		5
05060286001	016614		1/4"	65,0	11,0		5
05060410001	101044		5/16"	50,0	12,5		5
05060290001	016638		5/16"	65,0	12,5		5
05060411001	101051		3/8"	50,0	14,0		5
05060288001	016621		3/8"	65,0	14,0		5
05060412001	101068		7/16"	50,0	16,0		5



869/4 M Nutsetters, magnetic



	EAN						
Code	4013288	mm		mm	mm		
05060420001	101075	5,5		50,0	11,0		5
05060210001	016652	5,5		65,0	11,0		5
05060421001	101082	6,0		50,0	11,0		5
05060215001	016669	6,0		65,0	11,0		5
05060422001	101099	7,0		50,0	11,0		5
05060220001	016676	7,0		65,0	11,0		5
05060423001	101105	8,0		50,0	12,5		5
05060225001	016683	8,0		65,0	12,5		5
05060424001	101112	9,0		50,0	14,0		5
05060230001	016690	9,0		65,0	14,0		5
05060425001	101129	10,0		50,0	14,0		5
05060235001	016706	10,0		65,0	14,0		5
05060426001	101136	11,0		50,0	16,0		5
05060237001	031501	11,0		65,0	16,0		5
05060427001	101143	12,0		50,0	18,0		5
05060238001	031495	12,0		65,0	17,0		5
05060428001	101150	13,0		50,0	18,0		5
05060240001	016713	13,0		65,0	19,0		5
05060429001	101167		1/4"	50,0	11,0		5
05060255001	016720		1/4"	65,0	11,0		5
05060430001	101174		5/16"	50,0	12,5		5
05060260001	016737		5/16"	65,0	12,5		5
05060431001	101181		3/8"	50,0	14,0		5
05060265001	016744		3/8"	65,0	14,0		5
05060432001	101198		7/16"	50,0	16,0		5

869/4 M SB Nutsetters, magnetic



Code	EAN			
	4013288			
05073500001	105691		869/4 M 1x 5.5x50.0	3
05073501001	105707		869/4 M 1x 6.0x50.0	3
05073502001	105606		869/4 M 1x 7.0x50.0	3
05073503001	105714		869/4 M 1x 8.0x50.0	3
05073504001	105721		869/4 M 1x 9.0x50.0	3
05073505001	105738		869/4 M 1x 10.0x50.0	3
05073506001	105745		869/4 M 1x 11.0x50.0	3
05073507001	105752		869/4 M 1x 12.0x50.0	3
05073508001	105769		869/4 M 1x 13.0x50.0	3
05073509001	105776		869/4 M 1x 1/4"x50.0	3
05073510001	105783		869/4 M 1x 3/8"x50.0	3

869/4 M Set A SB



Code	EAN			
05073495001	144584	●	869/4 M 1x 7.0x50.0; 1x 8.0x50.0; 1x 10.0x50.0; 1x 12.0x50.0; 1x 13.0x50.0; 1x 1/4"x50.0; 1x 5/16"x50.0; 1x 3/8"x50.0	1

869/9 Nutsetters

Metric nutsetter for hexagon head screws. Non-magnetic design. With 4 mm halfmoon drive for direct insertion in the power tool.

869/9 Nutsetters



	EAN	⊙	⏏	∅				
Code	4013288	mm	mm	mm				
05135224001	190505	2,5	44,0	5,0				10
05135225001	190499	3,0	44,0	5,0				10

879/4 Internal thread insertion tool

Insertion tool with internal thread for hanger bolts and threaded rods. 1/4" hexagon, suitable for holders as per DIN ISO 1173-F 6.3.

879/4 Internal thread insertion tool



	EAN	⊕	⏏	⏏	∅			
Code	4013288		mm		mm			
05135903001	035059	M8	50,0	2"	12,0			5
05135904001	035066	M10	50,0	2"	12,0			5

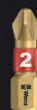



Holders and Adaptors



Impaktor system - For an above-average service life



Wera Impaktor holder for the absorption of impulse peaks. Particular torsion effect thanks to the double-torsion spring.

The retaining ring ensures an optimum fit of the tool in the holder. The magnet provides for additional fixing of the bit and screw.

The Impaktor stainless holder with retaining ring and magnet meets the extremely dynamic demands by doing without any small, mechanical parts that are often susceptible.

Used mostly for industrial assembly applications such as e.g. with screwdriving robots. Output: suitable for bits with 1/4" hexagon head drive as per DIN ISO 1173-C 6.3. Drive: 1/4" hexagon, suitable for power screwdrivers with take-up as per DIN ISO 1173-F 6.3.

897/4 IMP Impaktor holder with retaining ring and magnet



	EAN						
Code	4013288		mm				
05057675001	157805	1/4"	75	3"	1/4"		5

897/4 IMP R Impaktor holder with retaining ring and ring magnet

The Impaktor holder additionally holds long and heavy screws extremely securely with its ring magnet. This enables rapid and dependable positioning of the screw.

Should, situation-related, the magnet not be desired e.g. when working with metal, it can be removed from the screwdriving zone and thereby be neutralised.

Used mostly for manual power tool applications. Output: suitable for bits with 1/4" hexagon head drive as per DIN ISO 1173-C 6.3. Drive: 1/4" hexagon, suitable for power screwdrivers with take-up as per DIN ISO 1173-F 6.3.

897/4 IMP R Impaktor holder with retaining ring and ring magnet



	EAN						
Code	4013288		mm				
05057676001	157812	1/4"	75	3"	1/4"		5

897/4 IMP R SB Impaktor holder with retaining ring and ring magnet



	EAN						
Code	4013288						
05073990001	157836					897/4 Impaktor R 1x 1/4"x75	3

Radidaptor - the amazing compact multifunction tool

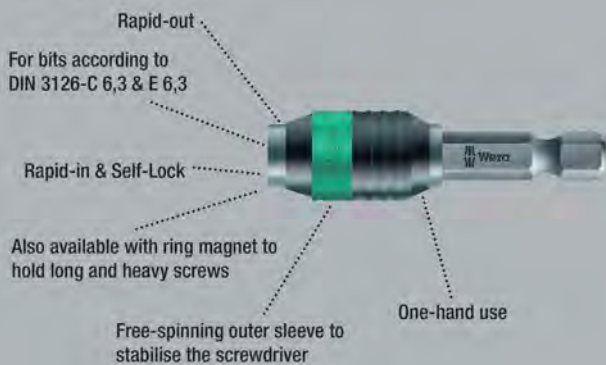

Universal holder for the take-up of bits with 1/4" hexagon head drive as per DIN ISO 1173-C 6.3 (ISO 1173). Stainless design to prevent extraneous rust.

Comes with Rapidaptor technology, which allows bits to be attached without any need to actuate the sleeve. The removal of the bit is simple, just by pushing the sleeve forward – for rapid bit change with just one hand. 1/4" hexagon, suitable for power screwdrivers with take-up as per DIN ISO 1173-F 6.3.

3888/4/1 K Rapidaptor Universal Bit Holder, stainless



	EAN							
Code	4013288		mm			mm		
05071100001	111487	1/4"	50	2"	1/4"	15,0		5

3888/4/1 K SB Rapidaptor Universal Bit Holder, stainless



Code	EAN			Code	Quantity	
05073616001	112170			3888/4/1 K 1x 1/4"x50		3

BiTorsion system - for longer service life



Universal holder for bits with 1/4" hexagon head drive as per DIN ISO 1173-C 6.3 and E 6.3 (ISO 1173). BiTorsion holders by Wera have a torsion spring that absorbs low peak loads during screwdriving jobs.

The combined use with BiTorsion bits and their torsion zones extends the service life of the tool considerably. BiTorsion holders by Wera can, however, also be used with conventional bits. The Rapidaptor technology allows bits to be attached without any need to actuate the sleeve.

The removal of the bit is simple, just by pushing the sleeve forward. This enables rapid bit change with just one hand. 1/4" hexagonal, suitable for power screwdrivers with take-up as per DIN ISO 1173-F 6.3.

897/4 R Rapidaptor BiTorsion Universal Bit Holder



	EAN							
Code	4013288		mm			mm		
05053923001	095633	1/4"	75	3"	1/4"	15,0		5

897/4 R SB Rapidaptor BiTorsion Universal Bit Holder



Code	EAN			Code	Quantity	
05073420001	099464			897/4 R 1x 1/4"x75		3

889/4/1 K Rapidaptor Universal Bit Holder

Rapidaptor universal holder for bits with 1/4" hexagon head drive as per DIN ISO 1173-C 6.3 and E 6.3 (ISO 1173). The Rapidaptor allows bits to be attached without any need to actuate the sleeve.

The removal of the bit is simple, just by pushing the sleeve forward. This enables rapid bit change with just one hand. The strong permanent magnet holds the bits absolutely securely. 1/4" hexagonal, suitable for power screwdrivers with take-up as per DIN ISO 1173-F 6.3.

889/4/1 K Rapidaptor Universal Bit Holder



	EAN						
Code	4013288		mm			mm	
05052502001	095626	1/4"	50	2"	1/4"	15,0	5

889/4/1 K SB Rapidaptor Universal Bit Holder



Code	EAN							
05073421001	099440			889/4/1 K				3
				1x 1/4"x50				

889/4/1 Rapidaptor Universal Bit Holder



	EAN						
Code	4013288		mm			mm	
05052503001	098016	1/4"	75	3"	1/4"	15,0	5

889/4 R Rapidaptor Universal Bit Holder



	EAN						
Code	4013288		mm			mm	
05052504001	101242	1/4"	100	4"	1/4"	15,0	2

888/4/1 K Rapidaptor Universal Bit holder

- Non-magnetic design

888/4/1 K Rapidaptor Universal Bit Holder



	EAN						
Code	4013288		mm			mm	
05052500001	095619	1/4"	50	2"	1/4"	15,0	5

887/4 RR Rapidaptor Universal Bit Holder with ring magnet

Rapidaptor universal holder for bits with hexagon head drive as per DIN ISO 1173-C 6.3 and E 6.3 (ISO 1173). The floating, free-turning magnetic sleeve securely holds even large and heavy screws. The Rapidaptor allows bits to be attached without any need to actuate the sleeve.

The removal of the bit is simple, just by pushing the sleeve forward. This enables rapid bit change with just one hand. 1/4" hexagonal, suitable for power screwdrivers with take-up as per DIN ISO 1173-F 6.3.

887/4 RR Rapidaptor Universal Bit Holder with ring magnet



	EAN						
Code	4013288		mm			mm	
05052490001	104045	1/4"	57	2 1/4"	1/4"	16	5

887/4 RR SB Rapidaptor Universal Bit Holder with ring magnet



Code	EAN							
05073511001	105790			887/4 RR				3
				1x 1/4"x57				

889/4/1 F Rapidaptor free-running bit holder for torque screwdrivers with pistol handle

The free-running feature allows for a particularly quick return movement without having to remove the screwdriver when tightening screws.

Especially for application with Wera torque screwdrivers with pistol handle for fast and ergonomic working.

The Rapidaptor technology allows mounting bits without activating the sleeve. Remove the bits by simply pushing the sleeve forward - for rapid bit change, all with one hand.

- Avoids annoying re-positioning when tightening screws with Wera torque screwdrivers with pistol handle
- Fast and fatigue-free work due to precise free-running mechanism
- Maintenance-free construction with especially slim and solid bearing by leading free-running manufacturer
- Maximum transmissible tightening moment 10,0 Nm
- Bit mounting with Rapidaptor technology for rapid bit change, suitable for bits with 1/4" - external hexagon drive as per DIN ISO 1173-C 6.3 and E 6.3 and Wera connection series 1 and 4

889/4/1 F Rapidaptor free-running bit holder for torque screwdrivers with pistol handle



	EAN							
Code	4013288		mm				mm	
05052501001	217585	1/4"	64	2 33/64"	1/4"	16,5		5

894/4/1 K Universal Bit Holder

Universal holder for the take-up of bits with 1/4" hexagon head drive as per DIN ISO 1173-C 6.3.

Quick-release chuck for rapid bit change. 1/4" hexagonal, suitable for power screwdrivers with take-up as per DIN ISO 1173-F 6.3.

894/4/1 K Universal Bit Holder



	EAN							
Code	4013288		mm				mm	
05053522001	017512	1/4"	51	2"	1/4"	14,3		5

894/4/1 Universal Bit Holder



	EAN							
Code	4013288		mm				mm	
05053520001	017505	1/4"	75	3"	1/4"	14,3		5

895/4/1 K Universal Bit Holder

Universal holder for the take-up of bits with 1/4" hexagon head drive as per DIN ISO 1173-C 6.3. Quick-release chuck for rapid bit change.

The strong permanent magnet holds the bits absolutely securely. 1/4" hexagonal, suitable for power screwdrivers with take-up as per DIN ISO 1173-F 6.3.

895/4/1 K Universal Bit Holder



	EAN							
Code	4013288		mm				mm	
05053872001	035158	1/4"	52	2"	1/4"	14,3		5

895/4/1 K SB Universal Bit Holder



Code	EAN							
05073318001	029195						895/4/1 K 1x 1/4"x52	3

895/4/1 Universal Bit Holder



	EAN							
Code	4013288		mm				mm	
05053870001	017574	1/4"	77	3"	1/4"	14,3		5

898/4 Combination Bit Holder

Combination holder for bits with 4 mm halfmoon drive (Wera series 9) and 4 mm HIOS drive (Wera series 21): quick-release chuck, 1/4" hexagonal drive, suitable for power screwdrivers with a take-up as per DIN ISO 1173-F 6.3.

898/4 Combination Bit Holder



	EAN						
Code	4013288	mm			mm		
05051500001	184177	50	2"	1/4"	10,0		5

898/9 Combination Bit Holder

Suitable for bits with 4 mm halfmoon drive (Wera series 9) and 4 mm HIOS drive (Wera series 21): with quick-release chuck, 4 mm halfmoon drive.

898/9 Combination Bit Holder



	EAN						
Code	4013288	mm		mm			
05051501001	184184	50	2"	10,0			5

898/21 Combination Bit Holder

Suitable for bits with 4 mm halfmoon drive (Wera series 9) and 4 mm HIOS drive (Wera series 21): with quick-release chuck, 4 mm HIOS drive.

898/21 Combination Bit Holder



	EAN						
Code	4013288	mm		mm			
05051502001	184191	50	2"	10,0			5

890/4/1 Universal Bit Holder

Universal holder for the take-up of bits with 1/4" hexagon head drive as per DIN ISO 1173-C 6.3. The retaining ring ensures an optimum fit of the tool in the holder.

1/4" hexagonal, suitable for power screwdrivers with take-up as per DIN ISO 1173-F 6.3.

890/4/1 Universal Bit Holder



	EAN							
Code	4013288		mm			mm		
05052575001	017239	1/4"	57	2 1/4"	1/4"	11,1		5

893/4/1 K Universal Bit Holder

Universal holder for the take-up of bits with 1/4" hexagon head drive as per DIN ISO 1173-C 6.3.

Stainless sleeve for special corrosion protection. 1/4" hexagon, suitable for power screwdrivers with a take-up as per DIN ISO 1173-F 6.3.

893/4/1 K Universal Bit Holder



	EAN							
Code	4013288		mm			mm		
05134480001	017468	1/4"	50	2"	1/4"	10,5		5

893/4/1 K SB Universal Bit Holder



	EAN						
Code	4013288						
05073401001	029133		893/4/1 K	1x 1/4"x50			3

899/3/1 Universal Bit Holder

Stainless steel sleeve for very special corrosion protection. The strong permanent magnet holds the bits absolutely securely.

Universal holder for the take-up of bits with 1/4" hexagon head drive as per DIN ISO 1173-C 6.3. 5.5 mm, suitable for power screwdrivers with take-up as per DIN ISO 1173-B 5.5.

899/3/1 Universal Bit Holder



	EAN						
Code	4013288		mm		mm	mm	
05053425001	017659	1/4"	72	2 3/4"	5,5	10,5	5

899/4/1 Universal Bit Holder

Stainless steel sleeve for very special corrosion protection. The retaining ring ensures an optimum fit of the tool in the holder. The strong permanent magnet holds the bits absolutely securely.

Universal holder for the take-up of bits with 1/4" hexagon head drive as per DIN ISO 1173-C 6.3. 1/4" hexagonal, suitable for power screwdrivers with take-up as per DIN ISO 1173-F 6.3.

899/4/1 Universal Bit Holder



	EAN							
Code	4013288	Art.No.		mm			mm	
05053457001	017673	899/4/1 K	1/4"	50	2"	1/4"	10,5	5
05053455001	017666	899/4/1 75	1/4"	75	3"	1/4"	10,5	5
05053459001	036711	899/4/1 100	1/4"	100	4"	1/4"	10,5	5
05053458001	036728	899/4/1 152	1/4"	152	6"	1/4"	10,5	5

899/4/1 SB Universal Bit Holder



Code	EAN							
05347100001	095268			899/4/1	1x 1/4"x50			3
05073357001	029720			899/4/1	1x 1/4"x75			3
05134398001	099907			899/4/1	1x 1/4"x152			3

899/4/1 S Universal Bit Holder with strong retaining ring

The particularly strong retaining ring ensures an optimum fixing of the tool in the holder. The especially strong permanent magnet makes sure that the bits are held absolutely securely.

Universal holder for the take-up of bits with 1/4" hexagon head drive as per DIN ISO 1173-C 6.3. 1/4" hexagon, suitable for holders as per DIN ISO 1173-F 6.3.

899/4/1 S Universal Bit Holder with strong retaining ring



	EAN						
Code	4013288		mm			mm	
05160976001	105271	1/4"	50	2"	1/4"	10,5	5
05160924001	105264	1/4"	75	3"	1/4"	10,5	5
05160977001	105288	1/4"	100	4"	1/4"	10,5	5
05160979001	105301	1/4"	200	8"	1/4"	10,5	1
05160981001	105325	1/4"	300	12"	1/4"	10,5	1

899/8/1 Universal Bit Holder

7 mm, suitable for power screwdrivers with take-up as per DIN ISO 1173-H 7.

899/8/1 Universal Bit Holder



	EAN						
Code	4013288		mm		mm	mm	
05053475001	017697	1/4"	75	3"	7	10,5	5

899/14/1 Universal Bit Holder

Drive: SDS plus.

899/14/1 SB Universal Bit Holder



Code	EAN							
05134397001	099891			899/14/1	1x 1/4"x79			3

881/4/1 SB Bit holder with variable screw depth limitation

For patio construction, the screws should be countersunk to be evenly flush with the decking.

The 881/4/1 bit holder with variable screw depth limitation and felt ring allows for a uniform depth and protects the surface from brush marks. Two spare felt rings included.

- Bit holder for evenly flush countersunk screws in patio construction
- With adjustable screw depth limitation
- Felt ring (exchangeable) prevents brush marks on decking
- Included: 2 spare felt rings

881/4/1 SB Bit holder with variable screw depth limitation



	Code	EAN		
	05130002001	4013288 219282		1
			881/4/1 1x 1/4"x90 ¹⁾	
			9201 2x 27,0	

¹⁾The spare part kit with 5x felt rings can be ordered with the code number 05130003001.

9200 Spare part kit felt rings for 881/4/1 bit holder

- Five spare felt rings for the 881/4/1 SB bit holder with variable screw depth limitation.
- Felt rings prevent brush marks on decking.

9200 Spare part kit felt rings for 881/4/1 bit holder



Code	EAN		
05130003001	4013288 219299		1
		9201 5x 27,0	

896/4/1 SB Bit Holder with adjustable depth-control stop

High quality spacer out of aluminium: the screwdriving depth can be infinitely adjusted and allows the flush-mounting of screws.

896/4/1 SB Bit Holder with adjustable depth-control stop



	Code	EAN		
	05073210001	4013288 178725		1
			896/4/1 1x 1/4"x50	

870/1 Adaptor

Tool shaft for nutsetters. Output: 1/4" square head; drive: 1/4" hexagon.

870/1 Adaptor



	EAN					
Code	4013288		mm			
05136000001 ¹⁾	016997	1/4"	25	1"	1/4"	5

¹⁾With friction ball; for manual nut spinner sockets

870/4 Adaptor

Tool shaft for manual nutsetter inserts; with ball. Output: 1/4" square head; drive 1/4" hexagon.

870/4 Adaptor



	EAN					
Code	4013288		mm			
05311517001 ¹⁾	098214	1/4"	50	2"	1/4"	10

¹⁾With friction ball; for manual nut spinner sockets

870/4 SB



Code	EAN	Icon	Product Name	Quantity
05134399001	4013288 099914		870/4 A 1x 1/4"x50 ¹⁾	3

¹⁾With friction ball; for manual nut spinner sockets

870/2 Adaptor

Tool shaft for power tool nutsetter inserts with square head drive.
5/16" hexagon drive.

870/2 Adaptor



Code	EAN	Icon	Length	Hex Size	Hex Size	Quantity
05136001001 ¹⁾	4013288 184245		mm	3/8"	1 3/16"	5
05136002001 ¹⁾	184269		35	1/2"	1 3/8"	5

¹⁾With friction ball; for manual nut spinner sockets

870/4 Adaptor

Tool shaft (adaptor) for power tool sockets with hexagon head drive by Wera.
Drive: 1/4" hexagon.

870/4 Adaptor



Code	EAN	Icon	Length	Hex Size	Hex Size	Quantity
05050205001 ¹⁾	4013288 017055		mm	1/4"	2"	5
05050210001 ¹⁾	017062		100	1/4"	4"	5
05050215001 ¹⁾	017079		50	3/8"	2"	5
05050220001 ¹⁾	017086		100	3/8"	4"	5

¹⁾With locking pin; for machine-operated nut spinner sockets

870/4/7 Set A SB



Code	EAN	Icon	Product Name	Quantity
05073200001	4013288 139115		870/4 1x 1/4"x50 ¹⁾ ; 1x 3/8"x50 ¹⁾	1
			870/7 1x 1/2"x75 ¹⁾	

¹⁾With locking pin; for machine-operated nut spinner sockets

870/14 Adaptor

Tool shaft for power tool sockets with square head drive.
Drive: SDS plus.

870/14 Adaptor



Code	EAN	Icon	Length	Hex Size	Quantity
05050650001 ¹⁾	4013288 017208		mm	1/4"	5
			70	2 3/4"	

¹⁾With locking pin; for machine-operated nut spinner sockets

870/7 Adaptor

Tool shank for power tool sockets; square head output.
7/16" hexagonal, suitable for power screwdrivers with take-up as per DIN ISO 1173-F 11.2.

870/7 Adaptor



Code	EAN	Icon	Length	Hex Size	Hex Size	Quantity
05050510001 ¹⁾	4013288 017178		mm	1/2"	75	5
			3"	7/16"		

¹⁾With locking pin; for machine-operated nut spinner sockets

781 A 1/4" Connection parts

Connection part 1/4" square head socket to 3/8" (1/2") external square head. For manual and machine-operated tools (non-impact), with ball stop groove to safely lock the socket, knurling at the rear end for manageability during manual use; chrome-vanadium, brushed chrome-plated finish.

- With 1/4" square head socket drive
- With secure socket fixing
- Made of chrome-vanadium for high load capacity

781 A 1/4" Connection parts



Code	EAN	Art.No.	mm	mm	mm	mm	mm
05042670001	221193	781 A/B	3/8"	25,2	1"	1/4"	1
05042671001	221209	781 A/C	1/2"	36,0	1 27/64"	1/4"	1

781 B 3/8" Connection parts

Connection part 3/8" square head socket to 1/4" (1/2") external square head. For manual and machine-operated tools (non-impact), with ball stop groove to safely lock the socket, knurling at the rear end for manageability during manual use; chrome-vanadium, brushed chrome-plated finish.

- With 3/8" square head socket drive
- With secure socket fixing
- Made of chrome-vanadium for high load capacity

781 B 3/8" Connection parts



Code	EAN	Art.No.	mm	mm	mm	mm	mm
05042672001	221247	781 B/A	1/4"	27,0	1 1/16"	3/8"	1
05042673001	221056	781 B/C	1/2"	36,0	1 27/64"	3/8"	1

781 C 1/2" Connection parts

Connection part 1/2" square head socket to 3/8" external square head. For manual and machine-operated tools (non-impact), with ball stop groove to safely lock the socket, knurling at the rear end for manageability during manual use; chrome-vanadium, brushed chrome-plated finish.

- With 1/2" square head socket drive
- With secure socket fixing
- Made of chrome-vanadium for high load capacity

781 C 1/2" Connection parts



Code	EAN	Art.No.	mm	mm	mm	mm	mm
05042674001	221216	781 C/B	3/8"	35,5	1 25/64"	1/2"	1

781/5 Set 1

Robust textile belt with 5 connection parts: 781 A: 1/4" square head socket drive, for 3/8" and 1/2" square head socket wrench inserts with ball lock; 781 B: 3/8" square head socket drive, for 1/4" and 1/2" square head socket wrench inserts with ball lock; 781 C: 1/2" square head socket drive, for 3/8" square head socket wrench inserts with ball lock.

- Set with 5 connection parts (adapters) for square head socket wrench inserts
- With secure socket fixing
- With square head socket drive
- With external square head drive
- Made of chrome-vanadium for high load capacity

781/5 Set 1



Code	EAN	Art.No.	mm	mm	mm	mm	mm	
05042680001	221223						1	
		781 A						
		1x 781 A/B, 3/8"x25,2x1/4"; 1x 781 A/C, 1/2"x36,0x1/4"						
		781 B						
		1x 781 B/A, 1/4"x27,0x3/8"; 1x 781 B/C, 1/2"x36,0x3/8"						
		781 C						
		1x 781 C/B, 3/8"x35,5x1/2"						
		Belt 781 0/5						
		1x 45,0x210,0						

784 A 1/4" Adaptor with quick-release chuck

Adaptor from square to hexagonal. Comes with quick-release chuck for rapid bit change.

Suitable for the attachment of bits with 1/4" hexagon drive as per DIN ISO 1173-C 6.3. Drive: 1/4" square.

784 A 1/4" Adaptor with quick-release chuck



	EAN						
Code	4013288	Art.No.	mm				
05042750001	008022	784 A/1	1/4"	30	1 3/16"	1/4"	5

784 B 3/8" Adaptor with quick-release chuck



	EAN						
Code	4013288	Art.No.	mm				
05042755001	008039	784 B/1	1/4"	43	1 5/8"	3/8"	5
05042765001	008046	784 B/2	5/16"	50	2"	3/8"	5

784 C 1/2" Adaptor with quick-release chuck



	EAN						
Code	4013288	Art.No.	mm				
05042760001	008053	784 C/1	1/4"	50	2"	1/2"	5
05042768001	008060	784 C/2	5/16"	50	2"	1/2"	5

780 A 1/4" Adaptor

Adaptor from square to hexagonal. Suitable for bits with 1/4" hexagon drive as per DIN ISO 1173-C 6.3.

Drive: 1/4" square.

780 A 1/4" Adaptor

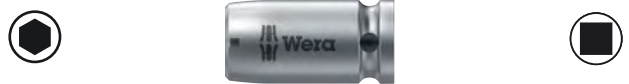

	EAN						
Code	4013288	Art.No.	mm				
05042605001	007940	780 A/1	1/4"	25	1"	1/4"	5

780 B 3/8" Adaptor



	EAN						
Code	4013288	Art.No.	mm				
05042655001	007971	780 B/1	1/4"	30	1 3/16"	3/8"	5
05344511001 ¹⁾	113450	780 B/1-S	1/4"	30	1 3/16"	3/8"	5
05042665001	007988	780 B/2	5/16"	30	1 3/16"	3/8"	5
05344512001 ¹⁾	113467	780 B/2-S	5/16"	30	1 3/16"	3/8"	5

¹⁾S = extra strong

780 C 1/2" Adaptor



	EAN						
Code	4013288	Art.No.	mm				
05042705001	007995	780 C/1	1/4"	35	1 3/8"	1/2"	5
05344513001	113474	780 C/1-S	1/4"	35	1 3/8"	1/2"	5
05042715001	008008	780 C/2	5/16"	35	1 3/8"	1/2"	5
05344514001 ¹⁾	113481	780 C/2-S	5/16"	35	1 3/8"	1/2"	5

¹⁾S = extra strong





Wera
BS - TOOL RANGE

Bit Sets



Impaktor system - For an above-average service life



The Impaktor technology offers an above-average service life even under extreme circumstances thanks to the best possible utilisation of the material properties and the optimised geometry; particularly suitable for use with customary impact drivers.

The rough diamond-coating of the bits reduces the risk of a slipping out of the screw head thanks to the enhanced frictional resistance.

The profile and size of the bits are easy to recognise thanks to the Wera Take it easy Tool Finder with its colour coding and clearly visible imprint.

The multi-component Bit-Check is convincing on account of its low weight and the maximum possible degree of compactness. In this respect, the soft material in the lower section of the Bit-Check ensures that the bits are securely held whilst being simple to remove at the same time.

Bit-Check 30 Impaktor 1



Code	EAN			
05057690001	156778			1
		<ul style="list-style-type: none"> ● 897/4 Impaktor R 1x 1/4"x75 ⊕ 851/1 IMP DC 2x PH 1x25; 3x PH 2x25; 2x PH 3x25 ⊕ 855/1 IMP DC 2x PZ 1x25; 3x PZ 2x25; 2x PZ 3x25 ⊕ 867/1 IMP DC 1x TX 10x25; 1x TX 15x25; 2x TX 20x25; 3x TX 25x25; 2x TX 30x25; 2x TX 40x25 ○ 840/1 IMP DC 1x 3,0x25; 1x 4,0x25; 1x 5,0x25; 1x 6,0x25 		

Bit-Check 30 Impaktor 2



Code	EAN			
05057697001	203946			1
		<ul style="list-style-type: none"> ● 897/4 Impaktor 1x 1/4"x75 ⊕ 851/1 IMP DC 2x PH 1x25; 3x PH 2x25; 2x PH 3x25 ⊕ 855/1 IMP DC 2x PZ 1x25; 3x PZ 2x25; 2x PZ 3x25 ⊕ 867/1 IMP DC 1x TX 10x25; 1x TX 15x25; 2x TX 20x25; 3x TX 25x25; 2x TX 30x25; 2x TX 40x25 ○ 840/1 IMP DC 1x 3,0x25; 1x 4,0x25; 1x 5,0x25; 1x 6,0x25 		

Bit-Check 10 Impaktor 1



Code	EAN			
05057680001	156785			10
		<ul style="list-style-type: none"> ● 897/4 Impaktor R 1x 1/4"x75 ⊕ 851/1 IMP DC 1x PH 2x25; 1x PH 3x25 ⊕ 855/1 IMP DC 1x PZ 2x25; 1x PZ 3x25 ⊕ 867/1 IMP DC 1x TX 20x25; 1x TX 25x25; 1x TX 30x25 ○ 840/1 IMP DC 1x 4,0x25; 1x 5,0x25 		

Bit-Check 10 Impaktor 1 SB

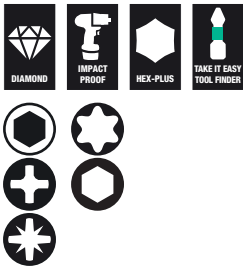

Code	EAN		
	4013288		
05073980001	158574	897/4 Impaktor R 1x 1/4"x75	1
		851/1 IMP DC 1x PH 2x251x PH 3x25	
		855/1 IMP DC 1x PZ 2x251x PZ 3x25	
		867/1 IMP DC 1x TX 20x251x TX 25x251x TX 30x25	
		840/1 IMP DC 1x 4.0x251x 5.0x25	

Bit-Check 10 Impaktor 2

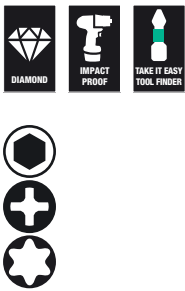

Code	EAN		
	4013288		
05057682001	156792		10
		897/4 Impaktor R 1x 1/4"x75	
		851/1 IMP DC 3x PH 2x25; 1x PH 3x25	
		867/1 IMP DC 3x TX 25x25; 1x TX 30x25; 1x TX 40x25	

Bit-Check 10 Impaktor 3



Code	EAN		
	4013288		
05057683001	156761		10
		897/4 Impaktor R 1x 1/4"x75	
		851/1 IMP DC 3x PZ 2x25; 1x PZ 3x25	
		867/1 IMP DC 3x TX 25x25; 1x TX 30x25; 1x TX 40x25	

Bit-Check 10 Impaktor 4

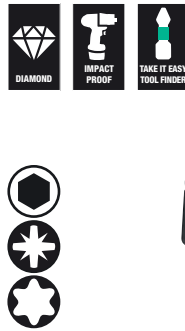

Code	EAN		
	4013288		
05057417001	180148		10
		897/4 Impaktor 1x 1/4"x75	
		855/1 IMP DC 3x PZ 2x25; 1x PZ 3x25	
		867/1 IMP DC 2x TX 20x25; 2x TX 25x25; 1x TX 30x25	

Bit-Check 10 PZ Impaktor 1

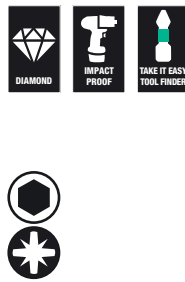

Code	EAN		
	4013288		
05057684001	157829		10
		897/4 Impaktor R 1x 1/4"x75	
		855/1 IMP DC 7x PZ 2x25; 2x PZ 3x25	

Bit-Check 10 TX Impaktor 1

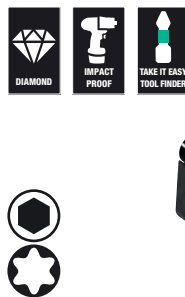

Code	EAN		
	4013288		
05057688001	163394		10
		897/4 Impaktor R 1x 1/4"x75	
		867/1 IMP DC 3x TX 20x25; 3x TX 25x25; 2x TX 30x25; 1x TX 40x25	



Bit-Check 6 Impaktor 1



Code	EAN		
05057695001	4013288 157751		10
		+	851/4 IMP DC 1x PH 2x50; 1x PH 3x50
		+	855/4 IMP DC 1x PZ 2x50; 1x PZ 3x50
		+	867/4 IMP DC 1x TX 25x50; 1x TX 30x50

Bit-Check 6 Impaktor 1 SB



Code	EAN		
05073890001	4013288 158635		1
		+	851/4 IMP DC 1x PH 2x50; 1x PH 3x50
		+	855/4 IMP DC 1x PZ 2x50; 1x PZ 3x50
		+	867/4 IMP DC 1x TX 25x50; 1x TX 30x50

Bit-Check 6 PH Impaktor 1



Code	EAN		
05057691001	4013288 157713		20
		+	851/4 IMP DC 4x PH 2x50; 2x PH 3x50

Bit-Check 6 PZ Impaktor 1



Code	EAN		
05057692001	4013288 157737		20
		+	855/4 IMP DC 4x PZ 2x50; 2x PZ 3x50

Bit-Check 6 TX Impaktor 1



Code	EAN		
05057693001	4013288 157744		20
		+	867/4 IMP DC 2x TX 20x50; 2x TX 25x50; 1x TX 30x50; 1x TX 40x50

Kraftform Stainless - stainless steel to prevent rust

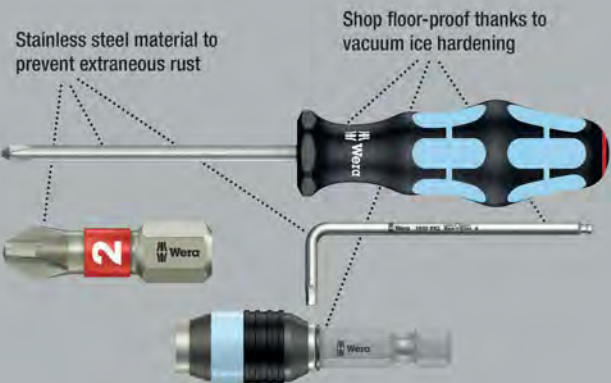

Bit-Check that can be positioned upright with high quality bits out of stainless steel. Wera stainless tools are manufactured out of stainless steel, thus preventing the formation of unsightly extraneous rust. The multi-component Bit-Check is convincing on account of its low weight and the maximum possible degree of compactness.

In this respect, the soft material in the lower section of the Bit-Check ensures that the bits are securely held whilst being simple to remove at the same time. The profile and size of the bits are easy to recognise thanks to the Wera Take it easy Tool Finder with its colour coding and clearly visible imprint.

Bit-Check 30 Stainless 1

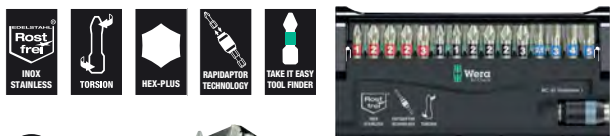

Code		EAN			
		4013288			
05071109001	115126				1
			3888/4/1 K		
			1x 1/4"x50		
			3851/1 TS PH		
			1x PH 1x25; 3x PH 2x25; 1x PH 3x25		
			3855/1 TS PZ		
			2x PZ 1x25; 3x PZ 2x25; 1x PZ 3x25		
			3867/1 TS TORX®		
			2x TX 10x25; 2x TX 15x25; 3x TX 20x25; 3x TX 25x25; 2x TX 30x25; 1x TX 40x25		
			3840/1 TS		
			1x 2,5x25; 1x 3,0x25; 1x 4,0x25; 1x 5,0x25; 1x 5,5x25		

Bit-Check 10 Stainless 1



Code		EAN			
		4013288			
05071110001	111494				10
			3888/4/1 K		
			1x 1/4"x50		
			3851/1 TS PH		
			1x PH 2x25		
			3855/1 TS PZ		
			1x PZ 1x25; 2x PZ 2x25		
			3867/1 TS TORX®		
			1x TX 10x25; 1x TX 15x25; 1x TX 20x25; 1x TX 25x25; 1x TX 30x25		

Bit-Check 10 Stainless 1 SB



Code		EAN			
		4013288			
05073630001	112163				1
			3888/4/1 K		
			1x 1/4"x50		
			3851/1 TS PH		
			1x PH 2x25		
			3855/1 TS PZ		
			1x PZ 1x25; 2x PZ 2x25		
			3867/1 TS TORX®		
			1x TX 10x25; 1x TX 15x25; 1x TX 20x25; 1x TX 25x25; 1x TX 30x25		

Bit-Check 6 Stainless 1 SB



Code		EAN			
		4013288			
05073634001	164636				1
			3855/4		
			2x PZ 2x50		
			3867/4 TORX®		
			1x TX 20x50; 2x TX 25x50		
			3840/4 Hex-Plus		
			1x 5.5x50		



BiTorsion system - for longer service life



Bit-Safe 61 BiTorsion 1

Robust textile box with bits and holder, 61-piece. 49 BiTorsion bits for long service life, in diamond-coated design (BDC) for a secure fit in the screw head, tough-absorbing (BTZ), for universal use, extra hard (BTH); 11 bits, tough-absorbing (Z), for universal use. 1 universal holder 889/4/1 K with quick-release chuck for take-up in the power screwdriver or use in the chuck of the power drill.

The profile and size of the bits are easy to recognise thanks to the Wera Take it easy Tool Finder with its colour coding and clearly visible imprint. The textile box allows users a high degree of mobility with a minimum space requirement.

The greatly reduced weight of a set makes carrying far more pleasant. Sensitive surfaces are protected when the box is set down – yet the textile box is still very robust. The box and the tools will even survive a fall unscathed.

Bit-Safe 61 BiTorsion 1



Code	EAN		
05057441001	4013288 179937		1
		● 889/4/1 K 1x 1/4"x50	
		⊕ 851/1 BDC PH 1x PH 1x25; 2x PH 2x25; 1x PH 3x25	
		⊕ 851/1 BTZ PH 2x PH 1x25; 8x PH 2x25; 1x PH 3x25	
		⊕ 855/1 BDC PZ 1x PZ 1x25; 2x PZ 2x25; 1x PZ 3x25	
		⊕ 855/1 BTH PZ 2x PZ 1x25; 8x PZ 2x25; 1x PZ 3x25	
		⊕ 867/1 TORX® BTZ 3x TX 10x25; 2x TX 15x25; 4x TX 20x25; 4x TX 25x25; 2x TX 30x25; 1x TX 40x25	
		● 800/1 BDC 1x 0,8x5,5x25; 1x 1,0x5,5x25; 1x 1,2x6,5x25	
		● 840/1 BTZ Hex-Plus 3x 2,5x25; 3x 3,0x25; 3x 4,0x25; 2x 5,0x25	

Bit-Checks BiTorsion

BiTorsion bits with an elastic torsion zone – where kinetic energy is diverted from peak loads – and softer BiTorsion zone to prevent the bit tip from twisting under high strain. This greatly extends the product service life. Offer the best possible service life with the appropriate holder.

The multi-component Bit-Check is convincing on account of its low weight and the maximum possible degree of compactness. In this respect, the soft material in the lower section of the Bit-Check ensures that the bits are securely held whilst being simple to remove at the same time. The profile and size of the bits are easy to recognise thanks to the Wera Take it easy Tool Finder with its colour coding and clearly visible imprint.

Bit-Check 30 BiTorsion 1



Code	EAN			
05057430001	4013288 179821			1
		●○	889/4/1 K 1x 1/4"x50	
		+	851/1 BTZ PH 2x PH 1x25; 5x PH 2x25; 2x PH 3x25	
		+	855/1 BTZ PZ 2x PZ 1x25; 6x PZ 2x25; 2x PZ 3x25	
		✦	867/1 TORX® BTZ 1x TX 10x25; 2x TX 15x25; 2x TX 20x25; 2x TX 25x25; 2x TX 30x25; 1x TX 40x25	

Bit-Check 12 BiTorsion 1



Code	EAN			
05057420001	4013288 179869			10
		●○	889/4/1 K 1x 1/4"x50	
		+	851/1 BTZ PH 1x PH 1x25; 2x PH 2x25	
		+	855/1 BTZ PZ 1x PZ 1x25; 2x PZ 2x25	
		✦	867/1 TORX® BTZ 1x TX 10x25; 1x TX 15x25; 1x TX 20x25; 1x TX 25x25; 1x TX 30x25	

Bit-Check 12 BiTorsion 1 SB



Code	EAN			
05136385001	4013288 213969			1
		●○	889/4/1 K 1x 1/4"x50	
		+	851/1 BTZ PH 1x PH 1x25; 2x PH 2x25	
		+	855/1 BTZ PZ 1x PZ 1x25; 2x PZ 2x25	
		✦	867/1 TORX® BTZ 1x TX 10x25; 1x TX 15x25; 1x TX 20x25; 1x TX 25x25; 1x TX 30x25	



Bit-Check 10 BiTorsion 1



Code	EAN			
05056374001	4013288 095688			10
		● ○	897/4 R 1x 1/4"x75	
		+	851/1 BTZ PH 1x PH 1x25; 1x PH 2x25; 1x PH 3x25	
		+	855/1 BTZ PZ 1x PZ 1x25; 1x PZ 2x25; 1x PZ 3x25	
		◐	800/1 BTZ 1x 0,8x5,5x25; 1x 1,0x5,5x25; 1x 1,2x6,5x25	

Bit-Check 10 BiTorsion 3 SB



Code	EAN			
05073418001	4013288 128157			1
		● ○	897/4 R 1x 1/4"x75	
		+	851/1 BTZ PH 1x PH 2x25	
		+	855/1 BTZ PZ 1x PZ 1x25; 1x PZ 2x25; 1x PZ 3x25	
		⊕	867/1 TORX® BTZ 1x TX 10x25; 1x TX 15x25; 1x TX 20x25; 1x TX 25x25; 1x TX 30x25	

Bit-Check 10 PZ BiTorsion 2



Code	EAN			
05347153001	4013288 107152			10
		● ○	897/4 R 1x 1/4"x75	
		+	855/1 BTH PZ 1x PZ 1x25; 7x PZ 2x25; 1x PZ 3x25	

Diamond-coated bits

Minute diamond particles on the tip of the tool literally bite into the screw

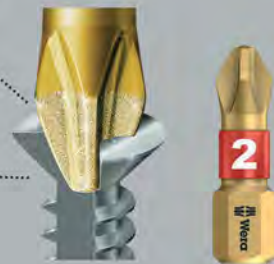

Bits fit securely into the head of the screw

Bits with tiny diamond particles on the bit tip. This ensures a secure fit in the screw head, reduces the contact pressure required and lowers the risk of slipping.

BiTorsion bits with an elastic torsion zone – where kinetic energy is diverted from peak loads – and softer BiTorsion zone to prevent the bit tip from twisting under high strain. This greatly extends the product service life.

The multi-component Bit-Check is convincing on account of its low weight and the maximum possible degree of compactness. In this respect, the soft material in the lower section of the Bit-Check ensures that the bits are securely held whilst being simple to remove at the same time.

The profile and size of the bits are easy to recognise thanks to the Wera Take it easy Tool Finder with its colour coding and clearly visible imprint.

Bit-Check 30 Diamond 1



Code	EAN			
05057431001	179814			1
			889/4/1 K 1x 1/4"x50	
			851/1 BDC PH 2x PH 1x25; 4x PH 2x25; 1x PH 3x25	
			855/1 BDC PZ 2x PZ 1x25; 4x PZ 2x25; 1x PZ 3x25	
			867/1 TORX® BDC 2x TX 10x25; 2x TX 15x25; 3x TX 20x25; 3x TX 25x25; 1x TX 30x25; 1x TX 40x25	
			800/1 BDC 1x 0,8x5,5x25; 1x 1,0x5,5x25; 1x 1,2x6,5x25	

Bit-Check 12 Diamond 1



Code	EAN			
05057421001	180025			10
			889/4/1 K 1x 1/4"x50	
			851/1 BDC PH 1x PH 1x25; 2x PH 2x25	
			855/1 BDC PZ 1x PZ 1x25; 2x PZ 2x25	
			867/1 TORX® BDC 1x TX 10x25; 1x TX 15x25; 1x TX 20x25; 1x TX 25x25; 1x TX 30x25	

Bit-Check 12 Diamond 1 SB



Code	EAN			
05136392001	213976			1
			889/4/1 K 1x 1/4"x50	
			851/1 BDC PH 1x PH 1x25; 2x PH 2x25	
			855/1 BDC PZ 1x PZ 1x25; 2x PZ 2x25	
			867/1 TORX® BDC 1x TX 10x25; 1x TX 15x25; 1x TX 20x25; 1x TX 25x25; 1x TX 30x25	

Bit-Check 7 Diamond 1



Code	EAN			
05057416001	179999			10
			889/4/1 K 1x 1/4"x50	
			851/1 BDC PH 1x PH 1x25; 1x PH 2x25	
			855/1 BDC PZ 1x PZ 1x25; 1x PZ 2x25	
			800/1 BDC 1x 1,0x5,5x25; 1x 1,2x6,5x25	



Bit-Check 7 Diamond 1 SB



Code	EAN			
05073419001	183682		889/4/1 K 1x 1/4"x50	1
			851/1 BDC PH 1x PH 1x25; 1x PH 2x25	
			855/1 BDC PZ 1x PZ 1x25; 1x PZ 2x25	
			800/1 BDC 1x 1.0x5.5x25; 1x 1.2x6.5x25	

Bit-Check 7 PZ Diamond 1



Code	EAN			
05057412001	180001		889/4/1 K 1x 1/4"x50	10
			855/1 BDC PZ 2x PZ 1x25; 3x PZ 2x25; 1x PZ 3x25	

Bit-Check 7 TX Diamond 1



Code	EAN			
05057415001	180018			10
			889/4/1 K 1x 1/4"x50	
			867/1 TORX® BDC 1x TX 10x25; 1x TX 15x25; 1x TX 20x25; 1x TX 25x25; 1x TX 30x25; 1x TX 40x25	

Textile boxes



Bit-Safe 61 Universal 1

Comprehensive 61-piece bit set in a robust Bit-Safe. Provides a quick overview of the tools available and bits not needed are simply reinserted into the set and do not get lost.

1 universal holder with Rapidaptor technology: allows bits to be attached without any need to actuate the sleeve. The removal of the bit is simple, just by pushing the sleeve forward – for rapid bit change with just one hand.

The strong permanent magnet holds the bits absolutely securely. Can be inserted in the power screwdriver or for use in the chuck of the electric drill.

Bit-Safe 61 Universal 1



Code	EAN			
05057122001	4013288 100689			1
		●○	889/4/1 K 1x 1/4"x50	
		+	851/1 TZ PH 3x PH 1x25; 10x PH 2x25; 2x PH 3x25	
		+	855/1 TZ PZ 3x PZ 1x25; 10x PZ 2x25; 2x PZ 3x25	
		✦	867/1 TZ TORX® 2x TX 10x25; 3x TX 15x25; 3x TX 20x25; 3x TX 25x25; 3x TX 30x25; 2x TX 40x25	
		—	800/1 TZ 1x 0,6x4,5x25; 1x 1,0x5,5x25; 1x 1,2x6,5x25	
		○	840/1 Z Hex-Plus 3x 2,5x25; 3x 3,0x25; 3x 4,0x25; 2x 5,0x25	

Bit-Safe 43 Universal 1

43-piece; robust textile box with bits for universal applications.

1 universal holder 899/4/1 with stainless sleeve, retaining ring and strong permanent magnet for insertion in the power screwdriver or for use in the chuck of the electric drill.

Bit-Safe 43 Universal 1



Code	EAN			
05057450001	4013288 179951			1
		●○	899/4/1 1x 1/4"x50	
		+	851/1 Z PH 1x PH 2x25	
		+	851/4 TZ PH 1x PH 1x50; 2x PH 2x50	
		+	855/1 Z PZ 2x PZ 1x25; 5x PZ 2x25; 2x PZ 3x25	
		+	855/4 TZ PZ 1x PZ 1x50; 2x PZ 2x50	
		✦	867/1 TORX® 3x TX 10x25; 4x TX 15x25; 4x TX 20x25; 4x TX 25x25; 4x TX 30x25; 1x TX 40x25	
		✦	867/4 Z TORX® 1x TX 10x50; 1x TX 15x50; 1x TX 20x50; 1x TX 25x50; 1x TX 30x50; 1x TX 40x50	



Bit-Check 30 Universal 1

29 bits in a minimum of space; simple removal and reinsertion of the bits. Rapidaptor holder ensures rapid bit change.

Universal bits fitted for diverse applications.

Bit-Check 30 Universal 1



Code	EAN		
05056440001	115096		1
		889/4/1 K 1x 1/4"x50	
		851/1 TZ PH 2x PH 1x25; 3x PH 2x25; 1x PH 3x25	
		855/1 TH PZ 2x PZ 1x25; 3x PZ 2x25; 1x PZ 3x25	
		867/1 TZ TORX® 1x TX 10x25; 1x TX 15x25; 1x TX 20x25; 1x TX 25x25; 1x TX 30x25; 1x TX 40x25	
		867/1 Z TORX® BO 1x TX 10x25; 1x TX 15x25; 1x TX 20x25; 1x TX 25x25; 1x TX 30x25	
		800/1 TZ 1x 1,0x5,5x25	
		840/1 Z Hex-Plus 1x 3,0x25; 1x 4,0x25; 1x 5,0x25; 1x 6,0x25; 1x 8,0x25	

Bit-Check 30 TX Universal 1

30-piece. Tough-absorbing bits for universal use. 1 universal holder 899/4/1 K for take-up in the power screwdriver or use in the chuck of the power drill.

Comes with tough viscous TORX® bits for universal use.

Bit-Check 30 TX Universal 1



Code	EAN		
05057908001	163820		10
		899/4/1 1x 1/4"x50	
		867/1 TORX® 3x TX 10x25; 5x TX 15x25; 8x TX 20x25; 7x TX 25x25; 4x TX 30x25; 2x TX 40x25	

Bit-Check 10 Universal 1

- Tough viscous bits for universal use
- Universal holder with quick-release chuck for rapid bit change

Bit-Check 10 Universal 1



Code	EAN		
05056161001	033772		10
		895/4/1 K 1x 1/4"x52	
		851/1 TZ PH 1x PH 1x25; 1x PH 2x25; 1x PH 3x25	
		855/1 TZ PZ 1x PZ 1x25; 1x PZ 2x25; 1x PZ 3x25	
		800/1 TZ 1x 0,8x5,5x25; 1x 1,0x5,5x25; 1x 1,2x6,5x25	

Bit-Check 10 Universal 2

- Extra-hard bits
- Torsion design against premature wear
- Universal holder with quick-release chuck and strong permanent magnet

Bit-Check 10 Universal 2



Code	EAN		
	4013288		
0513420001	038821		10
			895/4/1 K 1x 1/4"x52
			855/1 TH PZ 1x PZ 1x25; 2x PZ 2x25
			867/1 TORX® 1x TX 10x25; 1x TX 15x25; 1x TX 20x25; 1x TX 25x25; 1x TX 30x25; 1x TX 40x25

Bit-Check 10 Universal 3

- Tough viscous bits for universal use
- Rapidaptor holder for rapid bit change

Bit-Check 10 Universal 3



Code	EAN		
	4013288		
05056375001	095695		10
			889/4/1 K 1x 1/4"x50
			851/1 TZ PH 1x PH 1x25; 1x PH 2x25; 1x PH 3x25
			855/1 TZ PZ 1x PZ 1x25; 1x PZ 2x25; 1x PZ 3x25
			800/1 TZ 1x 0,8x5,5x25; 1x 1,0x5,5x25; 1x 1,2x6,5x25

Bit-Check 10 Universal 3 SB



Code	EAN		
	4013288		
05073410001	099495		1
			889/4/1 K 1x 1/4"x50
			800/1 TZ 1x 0,8x5,5x25; 1x 1,0x5,5x25; 1x 1,2x6,5x25
			851/1 TZ PH 1x PH 1x25; 1x PH 2x25; 1x PH 3x25
			855/1 TZ PZ 1x PZ 1x25; 1x PZ 2x25; 1x PZ 3x25

Bit-Check 10 Universal 4

- Tough viscous bits for universal use
- Universal holder with stainless sleeve, retaining ring and strong permanent magnet

Bit-Check 10 Universal 4



Code	EAN		
	4013288		
05056159001	033758		10
			899/4/1 1x 1/4"x50
			851/1 TZ PH 1x PH 1x25; 1x PH 2x25; 1x PH 3x25
			855/1 TZ PZ 1x PZ 1x25; 1x PZ 2x25; 1x PZ 3x25
			800/1 TZ 1x 0,8x5,5x25; 1x 1,0x5,5x25; 1x 1,2x6,5x25



Bit-Check 10 Universal 5 SB

- Tough viscous bits for universal use
- Includes universal holder for the take-up of bits with 1/4" hex head drive

Bit-Check 10 Universal 5 SB



Code	EAN			
05073416001	128164	4013288		1
		899/4/1	1x 1/4"x50	
		851/1 Z PH	1x PH 2x25	
		855/1 Z PZ	1x PZ 1x25; 1x PZ 2x25; 1x PZ 3x25	
		867/1 TORX®	1x TX 10x25; 1x TX 15x25; 1x TX 20x25; 1x TX 25x25; 1x TX 30x25	

Bit-Check 10 TX Universal 1

- Tough viscous bits for universal use
- Torsion design against premature wear
- Universal holder with quick-release chuck for rapid bit change

Bit-Check 10 TX Universal 1



Code	EAN			
05056164001	033802	4013288		10
		894/4/1 K	1x 1/4"x51	
		867/1 TZ TORX®	1x TX 8x25; 1x TX 9x25; 1x TX 10x25; 1x TX 15x25; 1x TX 20x25; 1x TX 25x25; 1x TX 27x25; 1x TX 30x25; 1x TX 40x25	

Bit-Check 10 TX Universal 2

- Tough viscous bits for universal use
- Rapidaptor holder for rapid bit change

Bit-Check 10 TX Universal 2



Code	EAN			
05057115001	127747	4013288		10
		888/4/1 K	1x 1/4"x50	
		867/1 TORX®	1x TX 6x25; 1x TX 8x25; 1x TX 9x25; 1x TX 10x25; 1x TX 15x25; 1x TX 20x25; 1x TX 25x25; 1x TX 30x25; 1x TX 40x25	

Bit-Check 7 Universal 1

- Tough viscous bits for universal use
- Universal holder with stainless sleeve and strong permanent magnet

Bit-Check 7 Universal 1



Code	EAN			
05056295001	038166	4013288		20
		893/4/1 K	1x 1/4"x50	
		851/1 Z PH	1x PH 1x25; 1x PH 2x25	
		855/1 Z PZ	1x PZ 1x25; 1x PZ 2x25	
		800/1 Z	1x 1,0x5,5x25; 1x 1,2x6,5x25	

Bit-Check 7 Universal 1 SB



Code	EAN		
05073406001	036186	893/4/1 K 1x 1/4"x50	1
		851/1 Z PH 1x PH 1x25; 1x PH 2x25	
		855/1 Z PZ 1x PZ 1x25; 1x PZ 2x25	
		800/1 Z 1x 1.0x5.5x25; 1x 1.2x6.5x25	

Bit-Check 7 Universal 4



Code	EAN		
05135810001	179265	893/4/1 K 1x 1/4"x50	20
		851/1 Z PH 1x PH 2x25	
		855/1 Z PZ 1x PZ 1x25; 1x PZ 2x25	
		867/1 TORX® 1x TX 15x25; 1x TX 20x25; 1x TX 25x25	

Bit-Check 7 PZ Universal 1



Code	EAN		
05056296001	038135	893/4/1 K 1x 1/4"x50	20
		855/1 Z PZ 2x PZ 1x25; 3x PZ 2x25; 1x PZ 3x25	

Bit-Check 7 TX Universal 1

- Tough viscous bits for universal use
- Universal holder with stainless sleeve and strong permanent magnet

Bit-Check 7 TX Universal 1



Code	EAN		
05056294001	041500	893/4/1 K 1x 1/4"x50	20
		867/1 TORX® 1x TX 10x25; 1x TX 15x25; 1x TX 20x25; 1x TX 25x25; 1x TX 30x25; 1x TX 40x25	

Bit-Check 7 TX Universal 1 SB



Code	EAN		
05073404001	038111	893/4/1 K 1x 1/4"x50	1
		867/1 TORX® 1x TX 10x25; 1x TX 15x25; 1x TX 20x25; 1x TX 25x25; 1x TX 30x25; 1x TX 40x25	

Bit-Check 7 TX B0 Universal 1

- Tough viscous bits for universal use
- Universal holder with quick-release chuck for rapid bit change

Bit-Check 7 TX B0 Universal 1



Code	EAN		
05056158001	4013288 033741		20
		894/4/1 K 1x 1/4"x51	
		867/1 Z TORX® B0 1x TX 10x25; 1x TX 15x25; 1x TX 20x25; 1x TX 25x25; 1x TX 30x25; 1x TX 40x25	

Hex-Plus - lets hexagon socket screws last longer

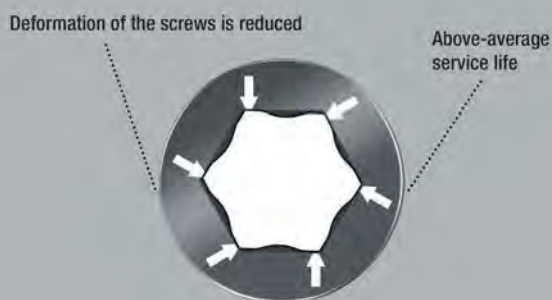

Bit-Check 7 Hex-Plus 1



Code	EAN		
05056168001	4013288 033840		20
		895/4/1 K 1x 1/4"x52	
		840/1 Z Hex-Plus 1x 2,0x25; 1x 2,5x25; 1x 3,0x25; 1x 4,0x25; 1x 5,0x25; 1x 6,0x25	

Bit-Check 6 Universal 1

- Tough viscous bits for universal use
- The Torsion design absorbs torque peaks
- Prevents premature breakage of the drive tip

Bit-Check 6 Universal 1



Code	EAN		
05056474001	4013288 156143		20
		851/4 TZ PH 1x PH 1x50; 1x PH 2x50	
		855/4 TZ PZ 1x PZ 1x50; 1x PZ 2x50	
		800/4 Z 1x 1,0x5,5x50; 1x 1,2x6,5x50	

Bit-Check 6 Universal 1 SB



Code	EAN		
05073635001	4013288 155276		1
		851/4 TZ PH 1x PH 1x50; 1x PH 2x50	
		855/4 TZ PZ 1x PZ 1x50; 1x PZ 2x50	
		800/4 Z 1x 1,0x5,5x50; 1x 1,2x6,5x50	

Bit-Check 6 Universal 2



Code	EAN		
	4013288		
05056473001	156136		20
		851/4 TZ PH 1x PH 2x50	
		855/4 TZ PZ 1x PZ 1x50; 1x PZ 2x50	
		867/4 Z TORX® 1x TX 15x50; 1x TX 20x50; 1x TX 25x50	

Bit-Check 6 Universal 2 SB



Code	EAN		
	4013288		
05073638001	155245	851/4 TZ PH 1x PH 2x50	1
		855/4 TZ PZ 1x PZ 1x50; 1x PZ 2x50	
		867/4 Z TORX® 1x TX 15x50; 1x TX 20x50; 1x TX 25x50	

Bit-Check 6 TX Universal 1

- Tough viscous bits for universal use

Bit-Check 6 TX Universal 1



Code	EAN		
	4013288		
05056472001	156112		20
		867/4 Z TORX® 1x TX 10x50; 1x TX 15x50; 1x TX 20x50; 1x TX 25x50; 1x TX 30x50; 1x TX 40x50	

Bit-Check 6 TX Universal 1 SB



Code	EAN		
	4013288		
05073637001	155252	867/4 Z TORX® 1x TX 10x50; 1x TX 15x50; 1x TX 20x50; 1x TX 25x50; 1x TX 30x50; 1x TX 40x50	1



Bit-Check 6 PZ Universal 1

6 50 mm-long Pozidriv bits tidily arranged in a minimum of space in a practical Bit-Check.

The tough viscous bits are suitable for universal use. Torsion design to combat premature wear.

Bit-Check 6 PZ Universal 1



Code	EAN		
	4013288		
05056471001	156105		20
			855/4 TZ PZ 2x PZ 1x50; 3x PZ 2x50; 1x PZ 3x50

Bit-Check 6 V Universal 1

6 50 mm-long bits tidily arranged in a minimum of space in a practical Bit-Check. Bits for square socket screws with holding function.

The wedging forces resulting from the contact pressure between the drive tip and the screw profile securely hold the screw on the tool. 1/4" hexagon, suitable for holders as per DIN ISO 1173-F 6.3.

Bit-Check 6 V Universal 1



Code	EAN		
	4013288		
05056478001	190802		10
			868/4 V 1x # 1x50; 3x # 2x50; 2x # 3x50

Bit-Check 30 Wood TX HF 1

Bits and holder set, particularly suitable for woodworking. With their special geometry and as per the Acument Intellectual Properties specification, the 867/1 TORX® HF bits hold TORX® screws securely on the tool!

This is particularly helpful in hard-to-reach work areas where the second hand cannot be used to hold the screw.

They are also suitable for Würth ASSY screws as well as Altenloh SPAX T-STAR plus screws.

With Take it easy tool finder: Colour coding by size. Rapidaptor holder for lightning-fast bit changes. The Bit-Check allows a quick overview of the available tools.

Unused bits are simply put back in the holder and will not be lost. Easy transport e.g. in the shirt pocket. The Bit-Check can be set up at the work place, which allows for quick access of the tools.

- Holding function for recessed TORX® screws
- Also suitable for Würth ASSY screws as well as Altenloh SPAX T-STAR plus screws

Bit-Check 30 Wood TX HF 1



Code	EAN		
	4013288		
05057436001	226204		10
			887/4 RR 1x 1/4"x57
			851/1 TZ 2x PH 2x25; 1x PH 3x25
			855/1 TH 3x PZ 1x25; 6x PZ 2x25; 2x PZ 3x25
			867/1 TORX® HF 2x TX 10x25; 2x TX 15x25; 4x TX 20x25; 4x TX 25x25; 2x TX 30x25; 1x TX 40x25 ¹⁾

¹⁾ Pound-thru hexagonal; no Take it easy.

Bit-Check 30 Wood 1

- Ring magnet Rapidaptor, holder for holding even longer and heavier screws

Bit-Check 30 Wood 1



Code	EAN			
05057433001	4013288 179807			1
			887/4 RR 1x 1/4"x57	
			851/1 TZ PH 2x PH 2x25; 1x PH 3x25	
			855/1 TH PZ 3x PZ 1x25; 6x PZ 2x25; 2x PZ 3x25	
			867/1 TZ TORX® 2x TX 10x25; 2x TX 15x25; 4x TX 20x25; 4x TX 25x25; 2x TX 30x25; 1x TX 40x25	

Bit-Check 30 Wood 2

- Universal holder with stainless sleeve

Bit-Check 30 Wood 2



Code	EAN			
05057432001	4013288 179845			10
			899/4/1 1x 1/4"x50	
			851/1 Z PH 1x PH 2x25	
			855/1 Z PZ 2x PZ 1x25; 5x PZ 2x25; 2x PZ 3x25	
			867/1 TORX® 3x TX 10x25; 4x TX 15x25; 4x TX 20x25; 4x TX 25x25; 3x TX 30x25; 1x TX 40x25	

Bit-Check 12 Wood TX HF 1

Bits and holder set, particularly suitable for woodworking. With their special geometry and as per the Acument Intellectual Properties specification, the 867/1 TORX® HF bits hold TORX® screws securely on the tool!

This is particularly helpful in hard-to-reach work areas where the second hand cannot be used to hold the screw. They are also suitable for Würth ASSY screws as well as Altenloh SPAX T-STAR plus screws.

With Take it easy tool finder: Colour coding by size. Ring magnet Rapidaptor holding tool to hold long and heavy screws.

The Bit-Check allows a quick overview of the available tools. Unused bits are simply put back in the holder and will not be lost.

Easy transport e.g. in the shirt pocket. The Bit-Check can be set up at the work place, which allows for quick access of the tools.

- 867/1 TORX® HF bits with holding function for TORX® screws as per the Acument Intellectual Properties specification
- Also suitable for Würth ASSY screws as well as Altenloh SPAX T-STAR plus screws

Bit-Check 12 Wood TX HF 1



Code	EAN			
05057435001	4013288 226198			10
			887/4 RR 1x 1/4"x57	
			855/1 Z 1x PZ 1x25; 1x PZ 2x25	
			867/1 TORX® HF 1x TX 10x25; 1x TX 15x25; 1x TX 20x25; 2x TX 25x25; 1x TX 30x25; 1x TX 40x25 ¹⁾	
			867/1 TORX® 1x TX 20x25; 1x TX 25x25	

¹⁾Pound-thru hexagonal; no Take it easy.



Bit-Check 12 Wood 1

- Ring magnet Rapidaptor, holder for holding even longer and heavier screws

Bit-Check 12 Wood 1



Code	EAN			
05057423001	179876			10
		●●	887/4 RR 1x 1/4"x57	
		+	855/1 TH PZ 1x PZ 1x25; 2x PZ 2x25; 1x PZ 3x25	
		+	851/1 TH PH 1x PH 2x25	
		✦	867/1 TORX® 1x TX 10x25; 1x TX 15x25; 1x TX 20x25; 1x TX 25x25; 1x TX 30x25; 1x TX 40x25	

Bit-Check 12 Wood 1 SB



Code	EAN			
05136390001	214010			1
		●●	887/4 RR 1x 1/4"x57	
		+	851/1 TH PH 1x PH 2x25	
		+	855/1 TH PZ 1x PZ 1x25; 2x PZ 2x25; 1x PZ 3x25	
		✦	867/1 TORX® 1x TX 10x25; 1x TX 15x25; 1x TX 20x25; 1x TX 25x25; 1x TX 30x25; 1x TX 40x25	

Bit-Check 12 Wood 2

- Universal holder with stainless sleeve

Bit-Check 12 Wood 2



Code	EAN			
05057422001	179890			10
		●●	899/4/1 1x 1/4"x50	
		+	851/1 Z PH 1x PH 2x25	
		+	855/1 Z PZ 1x PZ 1x25; 2x PZ 2x25; 1x PZ 3x25	
		✦	867/1 TORX® 1x TX 10x25; 1x TX 15x25; 1x TX 20x25; 1x TX 25x25; 1x TX 30x25; 1x TX 40x25	

Bit-Check 12 Wood 2 SB



Code	EAN			
05136391001	214027			1
		●●	899/4/1 1x 1/4"x50	
		+	851/1 Z PH 1x PH 2x25	
		+	855/1 Z PZ 1x PZ 1x25; 2x PZ 2x25; 1x PZ 3x25	
		✦	867/1 TORX® 1x TX 10x25; 1x TX 15x25; 1x TX 20x25; 1x TX 25x25; 1x TX 30x25; 1x TX 40x25	

Bit-Check 6 Wood TX HF 1

Bit-Set, particularly suitable for woodworking. With their special geometry and as per the Acument Intellectual Properties specification, the 867/4 TORX® HF bits hold TORX® screws securely on the tool!

This is particularly helpful in hard-to-reach work areas where the second hand cannot be used to hold the screw. They are also suitable for Würth ASSY screws as well as Altenloh SPAX T-STAR plus screws.

With Take it easy tool finder: Colour coding by size.

The Bit-Check allows a quick overview of the available tools. Unused bits are simply put back in the holder and will not be lost.

Easy transport e.g. in the shirt pocket. The Bit-Check can be set up at the work place, which allows for quick access of the tools.

- Particularly for wood applications
- For TORX® socket screws
- Holding function for TORX® screws
- Also suitable for Würth ASSY screws as well as Altenloh SPAX T-STAR plus screws
- 50 mm-long bits

Bit-Check 6 Wood TX HF 1



Code	EAN		
05056470001	4013288 226181		20
		867/4 TORX® HF 2x TX 20x50; 2x TX 25x50; 1x TX 30x50; 1x TX 40x50 ¹⁾	

¹⁾Pound-thru hexagonal; no Take it easy.

Bit-Check 30 Metal 1

- Tough viscous bits for universal use
- Universal holder with stainless sleeve and strong permanent magnet

Bit-Check 30 Metal 1



Code	EAN		
05057434001	4013288 179838		10
		899/4/1 1x 1/4"x50	
		851/1 Z PH 3x PH 1x25; 3x PH 2x25; 2x PH 3x25	
		855/1 Z PZ 3x PZ 1x25; 3x PZ 2x25; 3x PZ 3x25	
		867/1 TORX® 1x TX 10x25; 1x TX 15x25; 1x TX 20x25; 1x TX 25x25; 1x TX 30x25; 1x TX 40x25	
		800/1 Z 1x 0,6x4,5x25; 1x 1,0x5,5x25; 1x 1,2x6,5x25	
		840/1 Z Hex-Plus 1x 4,0x25; 1x 5,0x25; 1x 6,0x25	



888/4/1 K

Rapidaptor universal holder for bits with 1/4" hexagon drive.
Non-magnetic design.

844/7 Tap Bits Set



	Code	EAN		
	05104654001	4013288 119278		1
			888/4/1 K 1x 1/4"x50	
			844 1x 3,0x33,0; 1x 4,0x35,0; 1x 5,0x36,0; 1x 6,0x40,0; 1x 8,0x40,0; 1x 10,0x40,0	

845 1-flute Countersink Bits

1-flute countersink bit by Wera. For countersinking and de-burring. The hexagon shaft ensures very good power transfer, vibration-free and score-free working.

Perfect chip removal and long service life. 1/4" hexagon, suitable for holders as per DIN ISO 1173-D 6.3.

845 1-flute Countersink Bits



	EAN						
Code	4013288	mm	mm	mm			
05104660001	117519	6,30	21,00	32,0	M 3		1
05104661001	117526	8,30	21,00	32,0	M 4		1
05104662001	117533	10,40	21,00	34,0	M 5		1
05104663001	117540	12,40	21,00	36,0	M 6		1
05104664001	117557	16,50	22,00	40,0	M 8		1
05104665001	117564	20,50	22,00	43,0	M 10		1

816 R

Bit holder with Rapidaptor quick-release chuck for bits with 1/4" hexagon drive.

888/4/1 K

Rapidaptor universal holder for bits with 1/4" hexagon drive.
Non-magnetic design.

845/8 1-flute Countersink Bits Set



	Code	EAN		
	05104655001	4013288 119285		1
			816 R 1x 1/4"x119	
			888/4/1 K 1x 1/4"x50	
			845 1x 6,30x32,0; 1x 8,30x32,0; 1x 10,40x34,0; 1x 12,40x36,0; 1x 16,50x40,0; 1x 20,50x43,0	



846 3-flute Countersink Bit

3-flute countersink bit for deburring, chamfering and countersinking. A finely-tuned material elasticity provides for great durability.

Perfect chip removal and a low tilt risk ensure pleasant working. Cutting section as per DIN 335-C, 90° with 3 cutters. 1/4" hexagon, suitable for holders with take-up as per DIN ISO 1173-D 6.3.

846 3-flute Countersink Bit



Code	EAN					
05104630001	101440	6,30	20,00	31,0	M 3	1
05104631001	101457	8,30	20,00	31,0	M 4	1
05104632001	101464	10,40	20,00	34,0	M 5	1
05104633001	101471	12,40	20,00	35,0	M 6	1
05104634001	101488	16,50	20,00	40,0	M 8	1
05104635001	101495	20,50	20,00	41,0	M 10	1

816 R

Bit holder with Rapidaptor quick-release chuck for bits with 1/4" hexagon drive.

888/4/1 K

Rapidaptor universal holder for bits with 1/4" hexagon drive. Non-magnetic design.

846/8 3-flute Countersink Bits Set



Code	EAN		Description	
05104650001	111678		816 R 1x 1/4"x119	1
			888/4/1 K 1x 1/4"x50	
			846 HSS 1x 6,30x31,0; 1x 8,30x31,0; 1x 10,40x34,0; 1x 12,40x35,0; 1x 16,50x40,0; 1x 20,50x41,0	

847 HSS Combined Tap Bits

Combination tapping drill bits for drilling, tapping and deburring. Made out of high speed steel (HSS). A finely-tuned material elasticity provides for great durability.

The very good centring properties, perfect chip removal and a low tilt risk ensure pleasant working. The hexagonal shaft ensures very good power transfer. Drive: 1/4" hexagon, suitable for holders with take-up as per DIN ISO 1173-D 6.3.

847 HSS Combined Tap Bits



Code	EAN	Ø	L	L ₁	T		
05104640001	101501	2,5	12,00	36,0	M 3		1
05104641001	101518	3,3	12,00	39,0	M 4		1
05104642001	101525	4,2	12,00	41,0	M 5		1
05104643001	101532	5,0	12,00	44,0	M 6		1
05104644001	101549	6,8	12,00	51,0	M 8		1
05104645001	101556	8,5	12,00	59,0	M 10		1

888/4/1 K Rapidaptor Universal Bit holder

- Non-magnetic design

847/7 Set Combination Drill Bits Set



Code	EAN		
05104651001	111685		1
		888/4/1 K 1x 1/4"x50	
		847 HSS 1x 2,5x36,0; 1x 3,3x39,0; 1x 4,2x41,0; 1x 5,0x44,0; 1x 6,8x51,0; 1x 8,5x59,0	

848 HSS Metal Twist Drill Bits

Metal twist drill bits for precise drilling in metal. Made out of high speed steel (HSS). A finely-tuned material elasticity provides for a long service life. Very good concentricity.

Tough viscous tempered bits ensure a particularly long service life. The hexagonal shaft ensures very good power transfer.

Drive: 1/4" hexagon, suitable for holders as per DIN ISO 1173-D 6.3.

848 HSS Metal Twist Drill Bits



Code	EAN	Ø	L	L ₁			
05104610001	101310	3,0	16,00	38,0			1
05104611001	101327	3,1	18,00	40,0			1
05104612001	101334	3,3	18,00	40,0			1
05104613001	101341	4,0	20,00	44,0			1
05104614001	101358	4,1	20,00	44,0			1
05104615001	101365	4,2	20,00	45,0			1
05104616001	101372	5,0	26,00	50,0			1
05104617001	101389	5,1	26,00	50,0			1
05104618001	101396	6,0	26,00	50,0			1
05104619001	101402	6,8	30,00	50,0			1
05104620001	101419	8,0	32,00	51,0			1
05104621001	101426	8,5	33,00	53,0			1
05104622001	101433	10,0	38,00	54,0			1

849 HSS Twist Wood Drill Bits

Wood twist drill bits for precise, splinter-free drilling in soft wood, hard wood and laminated panel material. Made out of high speed steel (HSS).

The hexagonal shaft ensures very good power transfer. A finely-tuned material elasticity provides for a long service life. Very good concentricity. 1/4" drive suitable for holders as per DIN ISO 1173-D 6.3.

849 HSS Twist Wood Drill Bits



Code	EAN	Ø	L	L ₁			
05104600001	101259	3,0	32,00	70,0			1
05104601001	101266	4,0	32,00	74,0			1
05104602001	101273	5,0	43,00	85,0			1
05104603001	101280	6,0	45,00	95,0			1
05104604001	101297	8,0	60,00	110,0			1
05104605001	101303	10,0	70,00	120,0			1

848/851/867/19 Metal Twist Drill Bits and Bits Set

19-piece metal twist drill bit and bit set. High quality metal twist drill bits for precise drilling in metal.

Made out of high speed steel (HSS). A finely-tuned material elasticity provides for great durability.

Very good concentricity. The hexagonal shaft ensures very good power transfer. Tough viscous bits for universal use.

Drive: 1/4" hexagon, suitable for holders as per DIN ISO 1173-D 6.3. Includes robust belt pouch for secure storage.

848/851/867/19 Metal Twist Drill Bits and Bits Set



Code	EAN			
05104652001	111654			1
		●○	888/4/1 K 1x 1/4"x50	
		+	851/1 TZ PH 2x PH 1x25; 3x PH 2x25; 1x PH 3x25	
		⊗	848 HSS 1x 3,0x38,0; 1x 4,0x44,0; 1x 4,2x45,0; 1x 5,0x50,0; 1x 6,0x50,0; 1x 8,0x51,0	
		✱	867/1 TORX® 1x TX 10x25; 1x TX 15x25; 1x TX 20x25; 1x TX 25x25; 1x TX 30x25; 1x TX 40x25	

849/855/867/18 Wood Twist Drill Bits and Bits Set

18-piece wood twist drill bit and bit set. High quality, metal twist drill bits for precise, splinter-free drilling in soft wood, hard wood and laminated panel material.

Made out of high speed steel (HSS). A finely-tuned material elasticity provides for great durability. Very good concentricity.

The hexagonal shaft ensures very good power transfer. The Rapidaptor universal holder ensures rapid bit change without any extra tools. Drive: 1/4" hexagon, suitable for holders with take-up as per DIN ISO 1173-D 6.3.

849/855/867/18 Wood Twist Drill Bits and Bits Set



Code	EAN			
05104653001	111661			1
		●○	889/4/1 K 1x 1/4"x50	
		⊗	849 HSS 1x 3,0x70,0; 1x 4,0x74,0; 1x 5,0x85,0; 1x 6,0x95,0; 1x 8,0x110,0	
		+	855/1 TH PZ 2x PZ 1x25; 3x PZ 2x25; 1x PZ 3x25	
		✱	867/1 TORX® 1x TX 10x25; 1x TX 15x25; 1x TX 20x25; 1x TX 25x25; 1x TX 30x25; 1x TX 40x25	

Patio construction set T 1

Compact Wera tool set with the 17 most common screwdriving tools for patio construction. Bits in stainless steel design prevent extraneous rust.

With extra smart bit holder, which enables a uniform depth thanks to the variable screw depth limitation, and prevents damage to decking with the fitted felt ring.

- High-quality 17-piece tool set for evenly flush countersunk screw heads for decking in patio construction
- Bit holder with adjustable screw depth limitation and protective felt ring for surface protection
- 15 bits (TORX®, PH, PZ) made from stainless steel to prevent extraneous rust plus 3888/4/1 K Rapidaptor stainless steel bit holder
- Take it easy tool finder: colour coding according to profile and size
- Compact folding bag with Wera 2go compatibility incl. 4 spare felt rings

Patio construction set T 1



Code	EAN			
05134021001	4013288 219510			1
		●●	881/4/1 1x 1/4"x90 ¹⁾	
		●●	3888/4/1 K 1x 1/4"x50	
		+	3851/1 TS PH 1x PH 1x25; 1x PH 2x25; 1x PH 3x25	
		+	3855/1 TS PZ 1x PZ 1x25; 2x PZ 2x25; 1x PZ 3x25	
		✱	3867/1 TS TORX® 1x TX 10x25; 1x TX 15x25; 1x TX 20x25; 1x TX 25x25; 1x TX 30x25; 1x TX 40x25	
		✱	3867/1 TS P TORX® 2x TX 25x25	
			9201 4x 27,0	

¹⁾The spare part kit with 5x felt rings can be ordered with the code number 05130003001.

Bit-Check 10 Drywall 1

Bit-Check for drywall construction. High quality spacer out of aluminium; the screwdriving depth can be infinitely adjusted and allows the flush-mounting of screws; 9 drywall bits with modified output shaft, 25 mm in length.

Bit-Check 10 Drywall 1



Code	EAN			
05136011001	4013288 178657			1
		●●	896/4/1 1x 1/4"x50	
		+	851/1 RZ PH 9x PH 2x25	





Torque Tools



Series 7400 Krafftform adjustable torque screwdrivers with Rapidaptor quick-release chuck

Variable torque setting option with highest precision. Simple adjustment of the required torque value without any special tools. Easy-to-read scale value; audible click signal. Rapidaptor quick-release technology for rapid bit change. Unlimited torque to loosen seized screws.

Multi-component Krafftform handle with hard and soft zones for high working speeds, whilst being easy on the hand.

Suitable for bits with 1/4" hexagon head drive as per DIN ISO 1173-C 6.3 and E 6.3 (ISO 1173).

Series 7400 Krafftform adjustable torque screwdrivers (0.1-3.0 Nm) with Rapidaptor quick-release chuck



	EAN							
Code	4013288	Art.No.		Nm	Nm	mm	mm	
05074770001 ¹⁾	179012	7430	1/4"	0,10-0,34	0,015	89	142	1
05074772001 ¹⁾	179128	7431	1/4"	0,30-1,00	0,05	89	142	1
05074774001 ¹⁾	179135	7432	1/4"	0,90-1,50	0,05	89	142	1
05074700001	100641	7440	1/4"	0,3-1,2	0,05	105	155	1
05074701001	100658	7441	1/4"	1,2-3,0	0,10	105	155	1

¹⁾With attachable magnifying glass, dramatically improving visibility.

Series 7400 Krafftform pistol grip, adjustable torque screwdrivers (3.0-8.8 Nm) with Rapidaptor quick-release chuck



	EAN							
Code	4013288	Art.No.		Nm	Nm	mm	mm	
05074702001	101730	7442	1/4"	3,0-6,0	0,25	150	100	1
05074705001	119308	7443	1/4"	4,0-8,8	0,40	150	100	1

Series 7400 Krafftform ESD adjustable torque screwdrivers (0.1-3.0 Nm) with Rapidaptor quick-release chuck

- ESD-safe tool thanks to surface resistance of $\leq 10^9$ Ohm

Series 7400 Krafftform ESD adjustable torque screwdrivers (0.1-3.0 Nm) with Rapidaptor quick-release chuck



	EAN							
Code	4013288	Art.No.		Nm	Nm	mm	mm	
05074780001 ¹⁾	179159	7430 ESD	1/4"	0,10-0,34	0,015	89	142	1
05074782001 ¹⁾	179166	7431 ESD	1/4"	0,30-1,00	0,05	89	142	1
05074784001 ¹⁾	179173	7432 ESD	1/4"	0,90-1,50	0,05	89	142	1
05074730001	106964	7440 ESD	1/4"	0,3-1,2	0,05	105	155	1
05074731001	106971	7441 ESD	1/4"	1,2-3,0	0,10	105	155	1

¹⁾With attachable magnifying glass, dramatically improving visibility.

Series 7400 Krafftform adjustable torque screwdrivers (2.5-29.0 in. lbs.) with Rapidaptor quick-release chuck



	EAN							
Code	4013288	Art.No.		in. lbs.	in. lbs.	mm	mm	
05074710001	102881	7445	1/4"	2,5-11,5	0,5	105	155	1
05074711001	102898	7446	1/4"	11,0-29,0	1,0	105	155	1

Series 7400 Krafftform pistol grip, adjustable torque screwdrivers (25.0-55.0 in. lbs.) with Rapidaptor quick-release chuck



	EAN							
Code	4013288	Art.No.		in. lbs.	in. lbs.	mm	mm	
05074712001	102904	7447	1/4"	25,0-55,0	2,5	150	100	1

Series 7400 Krafftform ESD adjustable torque screwdrivers (2.5-29.0 in. lbs.) with Rapidaptor quick-release chuck

- ESD-safe tool thanks to surface resistance of $\leq 10^9$ Ohm

Series 7400 Krafftform ESD adjustable torque screwdrivers (2.5-29.0 in. lbs.) with Rapidaptor quick-release chuck



	EAN							
Code	4013288	Art.No.		in. lbs.	in. lbs.	mm	mm	
05074733001	106988	7445 ESD	1/4"	2,5-11,5	0,5	105	155	1
05074734001	106995	7446 ESD	1/4"	11,0-29,0	1,0	105	155	1

Series 7400 Krafftform ESD adjustable torque screwdrivers (0.1-1.0 Nm)

- ESD-safe tool thanks to surface resistance of $\leq 10^9$ Ohm
- Suitable for bits with 4 mm halfmoon and 4 mm HIOS drive

Series 7400 Krafftform ESD adjustable torque screwdrivers (0.1-1.0 Nm)



	EAN							
Code	4013288	Art.No.	Nm	Nm	mm	mm		
05074786001 ¹⁾	179036	7435 ESD	0,10-0,34	0,015	89	142	5 7/16"	1
05074788001 ¹⁾	179029	7436 ESD	0,30-1,00	0,05	89	142	5 7/16"	1

¹⁾With attachable magnifying glass, dramatically improving visibility.

1430 Krafftform Micro ESD adjustable torque screwdrivers (0.02-0.11 Nm) with quick-release chuck

- ESD-safe tool thanks to surface resistance of $\leq 10^9$ Ohm
- Suitable for bits with 4 mm halfmoon and 4 mm HIOS drive
- Applications e.g. on smartphones, mobile phones, cameras, electronic equipment

1430 Krafftform Micro ESD adjustable torque screwdrivers (0.02-0.11 Nm) with quick-release chuck



	EAN						
Code	4013288	Art.No.	Nm	Nm	mm		
05074802001 ¹⁾	179043	1430 ESD	0,02-0,06	0,0025	141	5 7/16"	1
05074804001 ¹⁾	179104	1431 ESD	0,05-0,11	0,005	141	5 7/16"	1

¹⁾With attachable magnifying glass, dramatically improving visibility.





7440/41 Krafftorm torque screwdriver set 0.3-3.0 Nm

Two torque screwdrivers with variable torque setting option with highest precision. Simple adjustment of the required torque value without any special tools.

Easy-to-read scale value. Rapidaptor quick-release technology for rapid bit change. Unlimited torque to loosen seized screws.

Multi-component Krafftorm handle with hard and soft zones for high working speeds, whilst being easy on the hand.

Includes bit assortment in a high quality and stable plastic case.

7440/41 Krafftorm torque screwdriver set 0.3-3.0 Nm



Code	EAN		
05074738001	4013288 112354		1
		<ul style="list-style-type: none"> 7400 1x 7440, 1/4", 0,3-1,2 Nm; 1x 7441, 1/4", 1,2-3,0 Nm 	
		<ul style="list-style-type: none"> 867/1 TZ TORX® 1x TX 6x25; 1x TX 7x25; 1x TX 8x25; 1x TX 9x25; 1x TX 10x25; 1x TX 15x25; 1x TX 20x25; 1x TX 25x25; 1x TX 30x25 	
		<ul style="list-style-type: none"> 867/1 IP TORX PLUS® 1x 6 IPx25; 1x 7 IPx25; 1x 8 IPx25; 1x 9 IPx25; 1x 10 IPx25; 1x 15 IPx25; 1x 20 IPx25; 1x 25 IPx25; 1x 30 IPx25 	
		<ul style="list-style-type: none"> 840/1 Z Hex-Plus 1x 2,0x25; 1x 2,5x25; 1x 3,0x25; 1x 4,0x25; 1x 5,0x25; 1x 6,0x25 	

7445/46/47 Krafftorm torque screwdriver set 2.5-55.0 in. lbs.



Code	EAN		
05350451001	4013288 161383		1
		<ul style="list-style-type: none"> 7400 inch 1x 7445, 1/4", 2,5-11,5 in. lbs; 1x 7446, 1/4", 11,0-29,0 in. lbs 	
		<ul style="list-style-type: none"> 7400 PISTOLE inch 1x 7447, 25,0-55,0 in. lbs 	
		<ul style="list-style-type: none"> 867/1 TZ TORX® 1x TX 6x25; 1x TX 7x25; 1x TX 8x25; 1x TX 9x25; 1x TX 10x25; 1x TX 15x25; 1x TX 20x25; 1x TX 25x25; 1x TX 30x25 	
		<ul style="list-style-type: none"> 867/1 IP TORX PLUS® 1x 6 IPx25; 1x 7 IPx25; 1x 8 IPx25; 1x 9 IPx25; 1x 10 IPx25; 1x 15 IPx25; 1x 20 IPx25; 1x 25 IPx25; 1x 30 IPx25 	
		<ul style="list-style-type: none"> 840/1 Z Hex-Plus 1x 2,0x25; 1x 2,5x25; 1x 3,0x25; 1x 4,0x25; 1x 5,0x25; 1x 6,0x25 	

7440/41/42 Krafftorm torque screwdriver set 0.3-6.0 Nm



Code	EAN		
05074739001	4013288 113924		1
		<ul style="list-style-type: none"> 7400 1x 7440, 1/4", 0,3-1,2 Nm; 1x 7441, 1/4", 1,2-3,0 Nm 	
		<ul style="list-style-type: none"> 7400 PISTOLE 1x 7442, 3,0-6,0 Nm 	
		<ul style="list-style-type: none"> 867/1 TZ TORX® 1x TX 6x25; 1x TX 7x25; 1x TX 8x25; 1x TX 9x25; 1x TX 10x25; 1x TX 15x25; 1x TX 20x25; 1x TX 25x25; 1x TX 30x25 	
		<ul style="list-style-type: none"> 867/1 IP TORX PLUS® 1x 6 IPx25; 1x 7 IPx25; 1x 8 IPx25; 1x 9 IPx25; 1x 10 IPx25; 1x 15 IPx25; 1x 20 IPx25; 1x 25 IPx25; 1x 30 IPx25 	
		<ul style="list-style-type: none"> 840/1 Z Hex-Plus 1x 2,0x25; 1x 2,5x25; 1x 3,0x25; 1x 4,0x25; 1x 5,0x25; 1x 6,0x25 	

7443/61/9 Assembly set for tyre pressure control systems

9-piece tool set for the proper assembly and disassembly of tyre pressure control systems. Comes with torque technology for controlled screw tightening.

Hand tool with multi-component Kraftform handle for high working speeds and ergonomic working. Two pre-set tools to connect the union nut with the screw and to fasten the sensor component to the valve. An adjustable Kraftform pistol handle for torque values of between 4.0 and 8.8 Nm. Two TX bits with holding function, socket adaptor, two sockets plus a valve dolly (for applications up to 4.5 Nm). Suitable for tyre control, systems from e.g. Schrader®, Alligator®, VDO®.

7443/61/9 Assembly set for tyre pressure control systems

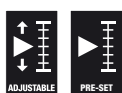

Code	EAN			
05074745001	4013288 168818			1
		7400 vor	1x 7461, 1,2 Nm	
		7400 Pistole	1x 7443, 4,0-8,8 Nm	
		300 TX	1x TX 10x1,4	
		870/1	1x 1/4"x25 ¹⁾	
		790 A/50	1x 11,0x50,0; 1x 12,0x50,0	
		867/4 TORX® HF	1x TX 15x50; 1x TX 20x50	
		327	1x 32	

¹⁾With friction ball; for manual nut spinner sockets

7443/12 Assembly set for tyre pressure control systems

12-piece tool set for the proper assembly and disassembly of tyre pressure control systems. Comes with torque technology for controlled screw tightening. Hand tool with multi-component Kraftform handle for high working speeds and ergonomic working. Five pre-set tools to connect the union nut with the screw and to fasten the sensor component to the valve. Two pre-set valve insertion tools with 0.25 and 0.45 Nm. An adjustable Kraftform pistol handle for torque values of between 4.0 and 8.8 Nm. Suitable for all customary tyre pressure control systems. Dependable fastening thanks to distinctly coloured marking of the pre-set torque values (Beru/Huf®: TX 10 yellow 1.25 Nm; Schrader®: TX 10 green 1.4 Nm; Cup®/RTS®: TX 20 grey 2.0 Nm). Two TX bits with holding function, socket adaptor, two sockets plus a valve dolly (for applications up to 4.5 Nm). Suitable for tyre control, systems from e.g. Schrader®, Alligator®, VDO®. The pre-set torque screwdriver fixed at 3.3 Nm actuates both the union nut as well as the connecting screw on the sensors of the Alligator system. Additionally included: socket adaptor, two bits, valve dolly (for applications up to 4.5 Nm).

7443/12 Assembly set for tyre pressure control systems

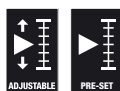

Code	EAN			
05074746001	4013288 178404			1
		7400 Pistole	1x 7443, 4,0-8,8 Nm	
		7400 vor	1x 7464, 3,3 Nm	
		300 TX	1x TX 10x1,25; 1x TX 10x1,4	
		790 A/50	1x 11,0x50,0; 1x 12,0x50,0	
		867/4 TORX® HF	1x TX 15x50; 1x TX 20x50	
		870/1	1x 1/4"x25 ¹⁾	
		300 V	1x 0,25; 1x 0,45	
		327	1x 32	

¹⁾With friction ball; for manual nut spinner sockets



Series 7400 Krafftform pre-set, adjustable torque screwdrivers (0,1-1,5 Nm) with Rapidaptor quick-release chuck, handle size 89 mm

Wera torque screwdriver. With a factory pre-set torque value set to the smallest scale value. For all applications, where the same constant torque and repeat accuracy are required. The torque can be changed with an extra tool within the measuring range (re-calibration kit can be ordered with the code number 05137003001).

Afterwards you can check the set value using an off-the-shelf torque tester. Unlimited loosening torque for slackening stuck screws. Rapidaptor quick-release technology for rapid bit changes.

Suitable for bits with a 1/4" external hexagon drive as per DIN ISO 1173-C 6.3 and E 6.3 (ISO 1173).

Multi-component Krafftform handle with hard and soft zones for high working speeds, whilst being easy on the hand.

Please note: 1 Ncm = 0.01 Nm.

Series 7400 Krafftform pre-set, adjustable torque screwdrivers (0,1-1,5 Nm) with Rapidaptor quick-release chuck, handle size 89 mm



Code	EAN	Art.No.	1/4"	Nm	Nm	mm	mm	
05074790001	179395	7450	1/4"	0,1	0,1-0,34	89	133	1
05074792001	179203	7451	1/4"	0,3	0,3-1,0	89	133	1
05074794001	179197	7452	1/4"	0,9	0,9-1,5	89	133	1

Series 7400 Krafftform pre-set, adjustable torque screwdrivers (0.3-3.0 Nm) with Rapidaptor quick-release chuck, handle size 105 mm

Wera torque screwdrivers. With a factory pre-set torque value set to the smallest scale value. For all applications, where the same constant torque and repeat accuracy are required. The torque can be changed with an extra tool within the measuring range (re-calibration kit can be ordered with the code number 05137001001).

Afterwards you can check the set value using an off-the-shelf torque tester. Unlimited loosening torque for slackening stuck screws. Rapidaptor quick-release technology for rapid bit changes.

Suitable for bits with a 1/4" external hexagon drive as per DIN ISO 1173-C 6.3 and E 6.3 (ISO 1173).

Multi-component Krafftform handle with hard and soft zones for high working speeds, whilst being easy on the hand.

Please note: 1 Ncm = 0.01 Nm.

Series 7400 Krafftform pre-set, adjustable torque screwdrivers (0.3-3.0 Nm) with Rapidaptor quick-release chuck, handle size 105 mm



Code	EAN	Art.No.	1/4"	Nm	Nm	mm	mm	
05074715001	102911	7460	1/4"	0,3	0,3-1,2	105	155	1
05074716001	102928	7461	1/4"	1,2	1,2-3,0	105	155	1

Series 7400 Kraftform pistol grip, pre-set adjustable torque screwdrivers (3.0-8.8 Nm) with Rapidaptor quick-release chuck

Wera torque screwdriver. Kraftform pistol handle for particularly high torque transmission, multi-component for high working speeds and particularly ergonomic screwdriving. With a factory pre-set torque value set to the smallest scale value. For all applications, where the same constant torque and repeat accuracy are required. The torque can be changed with an extra tool within the measuring range (re-calibration kit can be ordered with the code number 05137002001).

Afterwards you can check the set value using an off-the-shelf torque tester. Unlimited loosening torque for slackening stuck screws. Rapidaptor quick-release technology for rapid bit changes.

Suitable for bits with a 1/4" external hexagon drive as per DIN ISO 1173-C 6.3 and E 6.3 (ISO 1173).

Multi-component Kraftform handle with hard and soft zones for high working speeds, whilst being easy on the hand.

Suitable for bits with a 1/4" hexagon drive as per DIN ISO 1173-C 6.3 and E 6.3 (ISO 1173).

Please note: 1 Ncm = 0.01 Nm.

Series 7400 Kraftform pistol grip, pre-set adjustable torque screwdrivers (3.0-8.8 Nm) with Rapidaptor quick-release chuck



Code	EAN	Art.No.						
	4013288			Nm	Nm	mm	mm	
05074717001	102935	7462	1/4"	3,0	3,0-6,0	150	100	1
05074728001	156167	7463	1/4"	4,0	4,0-8,8	150	100	1

Series 7400 ESD Kraftform pre-set, adjustable torque screwdrivers (0,1-1,5 Nm) with Rapidaptor quick-release chuck, handle size 89 mm

Wera torque screwdriver. Safe protection against electrostatic charge and associated damage. With a factory pre-set torque value set to the smallest scale value. For all applications, where the same constant torque and repeat accuracy are required.

The torque can be changed with an extra tool within the measuring range (re-calibration kit can be ordered with the code number 05137003001).

Afterwards you can check the set value using an off-the-shelf torque tester. Rapidaptor quick-release technology for rapid bit changes. Unlimited loosening torque for slackening stuck screws.

Multi-component Kraftform handle with hard and soft zones for high working speeds, whilst being easy on the hand.

Suitable for bits with a 1/4" hexagon drive as per DIN ISO 1173-C 6.3 and E 6.3 (ISO 1173).

Please note: 1 Ncm = 0.01 Nm.

- ESD-safe tool thanks to surface resistance of $\leq 10^9$ Ohm

Series 7400 ESD Kraftform pre-set, adjustable torque screwdrivers (0,1-1,5 Nm) with Rapidaptor quick-release chuck, handle size 89 mm



Code	EAN	Art.No.						
	4013288			Nm	Nm	mm	mm	
05074820001	179210	7450 ESD	1/4"	0,1	0,1-0,34	89	133	1
05074822001	179470	7451 ESD	1/4"	0,3	0,3-1,0	89	133	1
05074824001	179227	7452 ESD	1/4"	0,9	0,9-1,5	89	133	1



Series 7400 ESD Kraftform pre-set, adjustable torque screwdrivers (0,1-1,5 Nm) with Rapidaptor quick-release chuck, handle size 105 mm

Wera torque screwdriver. Safe protection against electrostatic charge and associated damage. With a factory pre-set torque value set to the smallest scale value.

For all applications, where the same constant torque and repeat accuracy are required. The torque can be changed with an extra tool within the measuring range (re-calibration kit can be ordered with the code number 05137001001).

Afterwards you can check the set value using an off-the-shelf torque tester. Unlimited loosening torque for slackening stuck screws. Rapidaptor quick-release technology for rapid bit changes.

Suitable for bits with a 1/4" hexagon drive as per DIN ISO 1173-C 6.3 and E 6.3 (ISO 1173). Multi-component Kraftform handle with hard and soft zones for high working speeds, whilst being easy on the hand.

Please note: 1 Ncm = 0.01 Nm.

- ESD-safe tool thanks to surface resistance of $\leq 10^9$ Ohm

Series 7400 ESD Kraftform pre-set, adjustable torque screwdrivers (0,1-1,5 Nm) with Rapidaptor quick-release chuck, handle size 105 mm



Code	EAN	Art.No.	Hexagon Drive	Torque Scale 1	Torque Scale 2	Length	Bit Length	Weight
05074840001	179487	7460 ESD	1/4"	0,3	0,3-1,2	105	155	1
05074842001	179098	7461 ESD	1/4"	1,2	1,2-3,0	105	155	1

Series 7400 Imperial Kraftform pre-set adjustable torque screwdrivers (2.5-29.0 in. lbs.) with Rapidaptor quick-release chuck, handle size 105 mm

Wera torque screwdrivers. With a factory pre-set torque value set to the smallest scale value. For all applications, where the same constant torque and repeat accuracy are required.

The torque can be changed with an extra tool within the measuring range (re-calibration kit can be ordered with the code number 05137001001).

Afterwards you can check the set value using an off-the-shelf torque tester. Unlimited loosening torque for slackening stuck screws. Rapidaptor quick-release technology for rapid bit changes.

Suitable for bits with a 1/4" external hexagon drive as per DIN ISO 1173-C 6.3 and E 6.3 (ISO 1173). Multi-component Kraftform handle with hard and soft zones for high working speeds, whilst being easy on the hand.

Please note: 1 Ncm = 0.01 Nm.

Series 7400 Imperial Kraftform pre-set adjustable torque screwdrivers (2.5-29.0 in. lbs.) with Rapidaptor quick-release chuck, handle size 105 mm



Code	EAN	Art.No.	Hexagon Drive	Torque Scale 1	Torque Scale 2	Length	Bit Length	Weight
05074720001	102942	7465	1/4"	2,5	2,5-11,5	105	155	1
05074722001	103116	7466	1/4"	11,0	11,0-29,0	105	155	1

Series 7400Imperial Kraffform pistol grip, pre-set adjustable torque screwdriver (25.0-55.0 in. lbs.) with Rapidaptor quick-release chuck

Wera torque screwdriver. Kraffform pistol handle for particularly high torque transmission, multi-component for high working speeds and particularly ergonomic screwdriving.

With a factory pre-set torque value set to the smallest scale value. For all applications, where the same constant torque and repeat accuracy are required. The torque can be changed with an extra tool within the measuring range (re-calibration kit can be ordered with the code number 05137002001).

Afterwards you can check the set value using an off-the-shelf torque tester. Unlimited loosening torque for slackening stuck screws. Rapidaptor quick-release technology for rapid bit changes. Suitable for bits with a 1/4" external hexagon drive as per DIN ISO 1173-C 6.3 and E 6.3 (ISO 1173).

Multi-component Kraffform handle with hard and soft zones for high working speeds, whilst being easy on the hand.

Suitable for bits with a 1/4" hexagon drive as per DIN ISO 1173-C 6.3 and E 6.3 (ISO 1173).

Please note: 1 Ncm = 0.01 Nm.

Series 7400Imperial Kraffform pistol grip, pre-set adjustable torque screwdriver (25.0-55.0 in. lbs.) with Rapidaptor quick-release chuck



	EAN							
Code	4013288	Art.No.		in. lbs.	in. lbs.	mm	mm	
05074721001	102959	7467	1/4"	25,0	25,0-55,0	150	100	1

Serie 7400 ESD Kraffform pre-set adjustable torque screwdrivers (0.1-1.0 Nm) with quick-release chuck

Wera torque screwdriver. Safe protection against electrostatic charge and associated damage. With a factory pre-set torque value set to the smallest scale value.

For all applications, where the same constant torque and repeat accuracy are required. The torque can be changed with an extra tool within the measuring range (re-calibration kit can be ordered with the code number 05137003001).

Afterwards you can check the set value using an off-the-shelf torque tester. With quick-release chuck for rapid bit change. Unlimited loosening torque for slackening stuck screws.

Multi-component Kraffform handle with hard and soft zones for high working speeds, whilst being easy on the hand.

Suitable for bits with a 4 mm Halfmoon drive (Wera series 9) and a 4 mm HIOS drive (Wera series 21).

Please note: 1 Ncm = 0.01 Nm.

- ESD-safe tool thanks to surface resistance of $\leq 10^9$ Ohm
- Suitable for bits with 4 mm halfmoon and 4 mm HIOS drive

Serie 7400 ESD Kraffform pre-set adjustable torque screwdrivers (0.1-1.0 Nm) with quick-release chuck



	EAN							
Code	4013288	Art.No.	Nm	Nm	mm	mm		
05074826001	179067	7455 ESD	0,1	0,1-0,34	89	138	5 1/4"	1
05074828001	179050	7456 ESD	0,3	0,3-1,0	89	138	5 1/4"	1



1460 ESD Kraffform Micro pre-set adjustable torque screwdrivers (0.02-0.11 Nm) with quick-release chuck

With a factory pre-set torque value set to the smallest scale value. For all applications, where the same constant torque and repeat accuracy are required. The torque can be changed within the measuring range with the extra tool 05137004001.

Afterwards you can check the set value using an off-the-shelf torque tester.

Compact handle/interchangeable blades system for torque-controlled precision screwdriving. The Kraffform Micro ESD torque screwdriver is ideal for torque-controlled jobs on electrostatically sensitive components. Suitable for bits with a 4 mm Halfmoon drive (Wera series 9) and a 4 mm HIOS drive (Wera series 21). Tamper-proof. Clearly audible and tactile signal when the set torque is reached. Repeatability is 100% guaranteed. Unlimited manual loosening torque.

Electrical surface resistance $\leq 10^9$ ohms for safe protection against electrostatic charge.

Manufactured as per DIN EN 61340-5-1. Handle/interchangeable blades system for rapid blade changes. Kraffform Micro handle with rotating cap and free-turning zone for rapid turning, making any time-consuming repositioning of the fingers unnecessary.

Power zone with integrated soft zones ensures the transmission of high tightening and loosening torques. Precision zone directly above the blade for the correct rotation angle for adjustment work.

Rapid bit fixing: Simply push the bit into the holder for automatic locking and a secure fit. To change the bit, simply push the sleeve forward and remove the bit. Free-running actuating sleeve for easy handling of the tool during the screwdriving process.

Bits suitable for manual and machine operated screwdriving connections with electric screwdrivers (including HIOS, Delvo, Sehan). Use with e.g. smartphones, mobile phones, cameras, electronic devices, in dental laboratories and dental surgeries.

Please note: 1 Ncm = 0.01 Nm.

- ESD-safe tool thanks to surface resistance of $\leq 10^9$ Ohm
- Suitable for the take-up of bits with 4 mm halfmoon drive and 4 mm HIOS drive
- Applications e.g. on smartphones, mobile phones, cameras, electronic equipment

1460 ESD Kraffform Micro pre-set adjustable torque screwdrivers (0.02-0.11 Nm) with quick-release chuck



	EAN							
Code	4013288	Art.No.	Nm	Nm	mm	mm	mm	
05074800001	168351	1460 ESD	0,035	0,02-0,06	131	5 1/4"		1
05074810001	179463	1461 ESD	0,050	0,05-0,11	131	5 1/4"		1

Series 7400 Kraffform torque screwdrivers with a customised factory pre-set measurement value, handle size 89 mm

Wera torque screwdriver. With a customised factory pre-set torque value. For all applications, where the same constant torque and repeat accuracy are required.

The torque can be changed with an extra tool within the measuring range (re-calibration kit can be ordered with the code number 05137003001). Afterwards you can check the set value using an off-the-shelf torque tester.

Unlimited loosening torque for slackening stuck screws. Rapidaptor quick-release technology for rapid bit changes.

Suitable for bits with a 1/4" external hexagon drive as per DIN ISO 1173-C 6.3 and E 6.3 (ISO 1173).

Multi-component Kraffform handle with hard and soft zones for high working speeds, whilst being easy on the hand.

Please note: 1 Ncm = 0.01 Nm.

Series 7400 Kraffform torque screwdrivers with a customised factory pre-set measurement value, handle size 89 mm



	EAN							
Code	4013288	Art.No.	Nm	mm	mm	mm	mm	
05074790010	188106	7450	1/4"	0,1-0,34	89	133	5 1/4"	1
05074792010	188113	7451	1/4"	0,3-1,0	89	133	5 1/4"	1
05074794010	188137	7452	1/4"	0,9-1,5	89	133	5 1/4"	1

Series 7400 Krafftform torque screwdrivers with a customised factory pre-set measurement value, handle size 105 mm

Wera torque screwdriver. With a customised factory pre-set torque value. For all applications, where the same constant torque and repeat accuracy are required.

The torque can be changed with an extra tool within the measuring range (re-calibration kit can be ordered with the code number 05137001001). Afterwards you can check the set value using an off-the-shelf torque tester.

Unlimited loosening torque for slackening stuck screws.
Rapidaptor quick-release technology for rapid bit changes.

Suitable for bits with a 1/4" external hexagon drive as per DIN ISO 1173-C 6.3 and E 6.3 (ISO 1173).

Multi-component Krafftform handle with hard and soft zones for high working speeds, whilst being easy on the hand.

Please note: 1 Ncm = 0.01 Nm.

- Customized pre-set torque screwdriver with Rapidaptor quick-release chuck
- Only adjustable with an extra tool
- Suitable for bits with 1/4" hex head drive
- Distinct signal when pre-set value is reached
- Multi-component Krafftform handle for high working speeds

Series 7400 Krafftform torque screwdrivers with a customised factory pre-set measurement value, handle size 105 mm



	EAN	Art.No.						
Code	4013288	188144	7460	Nm	mm	mm	6"	1
05074715010	188144	7460	1/4"	0,3-1,2	105	155	6"	1
05074716010	188151	7461	1/4"	1,2-3,0	105	155	6"	1

Series 7400 Krafftform torque screwdrivers with a customised factory pre-set measurement value, pistol handle

Wera torque screwdriver. Krafftform pistol handle for particularly high torque transmission, multi-component for high working speeds and particularly ergonomic screwdriving.

With a customised factory pre-set torque value. For all applications, where the same constant torque and repeat accuracy are required. The torque can be changed with an extra tool within the measuring range (re-calibration kit can be ordered with the code number 05137002001). Afterwards you can check the set value using an off-the-shelf torque tester.

Rapidaptor quick-release technology for rapid bit changes.
Unlimited loosening torque for slackening stuck screws.

Multi-component Krafftform handle with hard and soft zones for high working speeds, whilst being easy on the hand.

Please note: 1 Ncm = 0.01 Nm.

Series 7400 Krafftform torque screwdrivers with a customised factory pre-set measurement value, pistol handle



	EAN	Art.No.						
Code	4013288	188168	7462	Nm	mm	mm	6"	1
05074717010	188168	7462	1/4"	3,0-6,0	150	100	6"	1
05074728010	188199	7463	1/4"	4,0-8,8	150	100	6"	1



Series 7400 ESD Kraftform torque screwdrivers with a customised factory pre-set measurement value, handle size 89 mm

Wera torque screwdriver. Safe protection against electrostatic charge and associated damage.

With a customised factory pre-set torque value.

For all applications, where the same constant torque and repeat accuracy are required.

The torque can be changed with an extra tool within the measuring range (re-calibration kit can be ordered with the code number 05137003001). Afterwards you can check the set value using an off-the-shelf torque tester.

Unlimited loosening torque for slackening stuck screws. Rapidaptor quick-release technology for rapid bit changes.

Suitable for bits with a 1/4" external hexagon drive as per DIN ISO 1173-C 6.3 and E 6.3 (ISO 1173).

Multi-component Kraftform handle with hard and soft zones for high working speeds, whilst being easy on the hand.

Please note: 1 Ncm = 0.01 Nm.

- ESD-safe tool thanks to surface resistance of $\leq 10^9$ Ohm

Series 7400 ESD Kraftform torque screwdrivers with a customised factory pre-set measurement value, handle size 105 mm

Wera torque screwdriver. Safe protection against electrostatic charge and associated damage. With a customised factory pre-set torque value.

For all applications, where the same constant torque and repeat accuracy are required.

The torque can be changed with an extra tool within the measuring range (re-calibration kit can be ordered with the code number 05137001001). Afterwards you can check the set value using an off-the-shelf torque tester.

Rapidaptor quick-release technology for rapid bit changes. Unlimited loosening torque for slackening stuck screws.

Multi-component Kraftform handle with hard and soft zones for high working speeds, whilst being easy on the hand.

Suitable for bits with a 1/4" external hexagon drive as per DIN ISO 1173-C 6.3 and E 6.3 (ISO 1173).

Please note: 1 Ncm = 0.01 Nm.

- ESD-safe tool thanks to surface resistance of $\leq 10^9$ Ohm

Series 7400 ESD Kraftform torque screwdrivers with a customised factory pre-set measurement value, handle size 89 mm



Code	EAN	Art.No.	Drive	Scale	Length	Width	Weight	Box
05074820010	188205	7450 ESD	1/4"	0,1-0,34	89	133	5 1/4"	1
05074822010	188212	7451 ESD	1/4"	0,3-1,0	89	133	5 1/4"	1
05074824010	188229	7452 ESD	1/4"	0,9-1,5	89	133	5 1/4"	1

Series 7400 ESD Kraftform torque screwdrivers with a customised factory pre-set measurement value, handle size 105 mm



Code	EAN	Art.No.	Drive	Scale	Length	Width	Weight	Box
05074840010	188236	7460 ESD	1/4"	0,3-1,2	105	133	6"	1
05074842010	188243	7461 ESD	1/4"	1,2-3,0	105	155	6"	1

Series 7400 Imperial Kraftform torque screwdrivers with a customised factory pre-set measurement value, handle size 105 mm

Wera torque screwdriver. With a customised factory pre-set torque value.

For all applications, where the same constant torque and repeat accuracy are required.

The torque can be changed with an extra tool within the measuring range (re-calibration kit can be ordered with the code number 05137001001). Afterwards you can check the set value using an off-the-shelf torque tester.

Unlimited loosening torque for slackening stuck screws.
Rapidaptor quick-release technology for rapid bit changes.

Suitable for bits with a 1/4" external hexagon drive as per DIN ISO 1173-C 6.3 and E 6.3 (ISO 1173).

Multi-component Kraftform handle with hard and soft zones for high working speeds, whilst being easy on the hand.

Please note: 1 Ncm = 0.01 Nm.

Series 7400 Imperial Kraftform torque screwdrivers with a customised factory pre-set measurement value, handle size 105 mm



	EAN	Art.No.						
Code			in. lbs.	mm	mm			
05074720010	188250	7465	1/4"	2,5-11,5	105	155	6"	1
05074722010	188267	7466	1/4"	11,0-29,0	105	155	6"	1

Series 7400 Imperial Kraftform torque screwdrivers with a customised factory pre-set measurement value, pistol handle

Wera torque screwdriver. Kraftform pistol handle for particularly high torque transmission, multi-component for high working speeds and particularly ergonomic screwdriving.

With a customised factory pre-set torque value. For all applications, where the same constant torque and repeat accuracy are required.

The torque can be changed with an extra tool within the measuring range (re-calibration kit can be ordered with the code number 05137002001). Afterwards you can check the set value using an off-the-shelf torque tester.

Rapidaptor quick-release technology for rapid bit changes.
Unlimited loosening torque for slackening stuck screws.

Multi-component Kraftform handle with hard and soft zones for high working speeds, whilst being easy on the hand.

Please note: 1 Ncm = 0.01 Nm.

Series 7400 Imperial Kraftform torque screwdrivers with a customised factory pre-set measurement value, pistol handle



	EAN	Art.No.							
Code			in. lbs.	mm	mm				
05074721010	188274	7467	1/4"	25,0-55,0	150	100	6"	1	



Series 7400 ESD Kraftform torque screwdrivers with a customised factory pre-set measurement value, with quick-release chuck

Wera torque screwdriver. Safe protection against electrostatic charge and associated damage. With a customised factory pre-set torque value.

For all applications, where the same constant torque and repeat accuracy are required.

The torque can be changed within the measuring range with the extra tool 05137003001. Afterwards you can check the set value using an off-the-shelf torque tester.

Rapidaptor quick-release technology for rapid bit changes. Unlimited loosening torque for slackening stuck screws.

Multi-component Kraftform handle with hard and soft zones for high working speeds, whilst being easy on the hand.

Suitable for bits with a 4 mm Halfmoon drive (Wera series 9) and a 4 mm HIOS drive (Wera series 21).

Please note: 1 Ncm = 0.01 Nm.

- ESD-safe tool thanks to surface resistance of $\leq 10^9$ Ohm
- Suitable for bits with 4 mm halfmoon and 4 mm HIOS drive

Series 7400 ESD Kraftform torque screwdrivers with a customised factory pre-set measurement value, with quick-release chuck



	EAN	Art.No.	Nm	mm	mm		
Code	4013288						
05074826010	188281	7455 ESD	0,1-0,34	89	138	5 1/4"	1
05074828010	188298	7456 ESD	0,3-1,0	89	138	5 1/4"	1

1460 ESD Kraftform Micro torque screwdrivers with a customised factory pre-set measurement value with quick-release chuck

With a customised factory pre-set torque value. The torque can be changed with an extra tool within the measuring range (re-calibration kit can be ordered with the code number 05137004001).

Afterwards you can check the set value using an off-the-shelf torque tester. Compact handle/interchangeable blades system for torque-controlled precision screwdriving.

The Kraftform Micro ESD torque screwdriver is ideal for torque-controlled jobs on electrostatically sensitive components. Suitable for bits with a 4 mm Halfmoon drive (Wera series 9) and a 4 mm HIOS drive (Wera series 21).

Tamper-proof. Clearly audible and tactile signal when the set torque is reached. Repeatability is 100% guaranteed. Unlimited manual loosening torque.

Electrical surface resistance $\leq 10^9$ ohms for safe protection against electrostatic charge.

Manufactured as per DIN EN 61340-5-1. Handle/interchangeable blades system for rapid blade changes.

Kraftform Micro handle with rotating cap and free-turning zone for rapid turning, making any time-consuming repositioning of the fingers unnecessary.

Power zone with integrated soft zones ensures the transmission of high tightening and loosening torques. Precision zone directly above the blade for the correct rotation angle for adjustment work. Rapid bit fixing: Simply push the bit into the holder for automatic locking and a secure fit.

To change the bit, simply push the sleeve forward and remove the bit. Free-running actuating sleeve for easy handling of the tool during the screwdriving process.

Bits suitable for manual and machine operated screwdriving connections with electric screwdrivers (including HIOS, Delvo, Sehan).

Use with e.g. smartphones, mobile phones, cameras, electronic devices, in dental laboratories and dental surgeries.

Please note: 1 Ncm = 0.01 Nm.

- ESD-safe tool thanks to surface resistance of $\leq 10^9$ Ohm
- Suitable for the take-up of bits with 4 mm halfmoon drive and 4 mm HIOS drive
- Applications e.g. on smartphones, mobile phones, cameras, electronic equipment

1460 ESD Krafftform Micro torque screwdrivers with a customised factory pre-set measurement value with quick-release chuck



	EAN	Art.No.	Nm	mm				
Code	4013288							
05074800010	188304	1460 ESD	0,02-0,06	131	5 1/4"			1
05074810010	188311	1461 ESD	0,05-0,11	131	5 1/4"			1

300 Hex Torque-indicator

Wera torque screwdriver with fixed torque for hexagon socket screws. Tamperproof and with a slim hex blade. Unlimited torque for loosening seized screws.

Multi-component Krafftform handle for pleasant, ergonomic working that prevents blisters and calluses. Hard gripping zones for high working speeds whereas soft zones ensure high torque transfer.

Comes with Hex-Plus profile which avoids any rounding of the screw head. The Black Point tip offers high corrosion protection and an exact fit.

300 Hex Torque-indicator



	EAN		Nm	ft. lb.	mm	mm	mm	
Code	4013288							
05027910001	096425	2,0	1,4	1,0	4	3,5	65	1
05027911001	096432	2,5	2,0	1,5	4	3,8	65	1
05027912001	096449	3,0	3,0	2,2	4	3,8	65	1

300 Hex Torque-indicator, pistol handle



	EAN		Nm	ft.lb.	mm	mm	mm	
Code	4013288							
05027913001	099150	4,0	5,0	3,7	160	100	65	1

300 TX TORX® Torque-indicator

- For recessed TORX® screws

300 TX TORX® Torque-indicator



	EAN		Nm	ft. lb.	mm	mm	mm	
Code	4013288							
05027930001	093325	TX 6	0,6	0,4	4	3,5	65	1
05027931001	093332	TX 7	0,9	0,7	4	3,5	65	1
05027932001	093349	TX 8	1,2	0,9	4	3,5	65	1
05027933001	093356	TX 9	1,4	1,0	4	3,5	65	1
05027934001	093370	TX 10	2,0	1,5	4	3,8	65	1
05027935001	093363	TX 15	3,0	2,2	4	3,8	65	1

300 TX TORX® Torque-indicator, pistol handle



	EAN		Nm	ft.lb.	mm	mm	mm	
Code	4013288							
05027936001	099143	TX 20	5,0	3,7	160	100	65	1

300 IP TORX PLUS® Torque-indicator

- For TORX PLUS® screws

300 IP TORX PLUS® Torque-indicator



	EAN		Nm	ft. lb.	mm	mm	mm	
Code	4013288							
05028040001	093387	6 IP	0,6	0,4	4	3,5	65	1
05028041001	093394	7 IP	0,9	0,7	4	3,5	65	1
05028042001	093431	8 IP	1,2	0,9	4	3,5	65	1
05028043001	093400	9 IP	1,4	1,0	4	3,5	65	1
05028044001	093417	10 IP	2,0	1,5	4	3,8	65	1
05028045001	093424	15 IP	3,0	2,2	4	3,8	65	1

300 IP TORX PLUS® Torque-indicator, pistol handle



	EAN							
Code	4013288		Nm	ft.lb.	mm	mm	mm	
05028046001	099136	20 IP	5,0	3,7	160	100	65	1

400 Hex Torque-indicator

Wera torque indicator with fixed torque for hexagon sockets. Tamper proof. The robust slip clutch guarantees a clearly audible and tactile trigger signal when the set torque value is reached, and it is therefore impossible to apply any further torque.

The loosening torque is significantly higher than the set tightening torque, therefore no additional tools are needed for loosening screw connections. The shape of the handle fills the whole hand well and the fingers lie in the softly rounded recessed grips. This ensures optimal, ergonomic power transmission.

400 Hex Torque-indicator



	EAN							
Code	4013288		Nm	mm	mm	mm		
05005080001	208835	4,0	4,0	60	48	100	2 3/8"	1
05005081001	208842	5,0	5,0	60	48	100	2 3/8"	1

400 TX Torque-indicator

- For recessed TORX® screws

400 TX Torque-indicator



	EAN							
Code	4013288		Nm	mm	mm	mm		
05005090001	208811	TX 20	4,0	60	48	100	2 3/8"	1
05005091001	208828	TX 25	5,0	60	48	100	2 3/8"	1

Click-Torque A 5 torque wrench with reversible ratchet

Click-Torque wrench in the unmistakable, robust Wera design with high accuracy as per DIN EN ISO 6789-1: 2017-07. Easy setting and saving of the default value.

The audible and tactile clicks on reaching the scale values also facilitate the safe setting of the desired torque value. The robust release mechanism guarantees a clearly audible and tactile release signal when the set torque is reached.

For right-hand use (clockwise torque-control) and with 45-tooth reversible ratchet mechanism.

- With 1/4" square drive, reversible ratchet, 45 teeth
- Measuring range: 2.5-25 Nm; precise to +/- 4% as per DIN EN ISO 6789-1:2017-07

Click-Torque A 5 torque wrench with reversible ratchet, 2.5-25 Nm



	EAN							
Code	4013288		Nm	Nm	lbf. ft.	mm	mm	
05075604001	193179	1/4"	2,5-25	1,0	1-18	290	121	1

Click-Torque A 6 torque wrench with reversible ratchet

- With 1/4" hex drive, reversible ratchet, 45 teeth
- Measuring range: 2.5-25 Nm; precise to +/- 4% as per DIN EN ISO 6789-1:2017-07

Click-Torque A 6 torque wrench with reversible ratchet, 2.5-25 Nm



	EAN							
Code	4013288		Nm	Nm	lbf. ft.	mm	mm	
05075605001	193186	1/4"	2,5-25	1,0	1-18	290	121	1

Click-Torque A 6 Set 1

Click torque wrench in the unmistakable Wera design. Very robust design with high accuracy as per DIN EN ISO 6789-1: 2017-07.

Easy setting and saving of the default value. The audible and tactile clicks on reaching the scale values facilitate the safe setting of the desired torque value. The robust release mechanism guarantees a clearly audible and tactile release signal when the set torque is reached.

Provides clockwise torque-control and 45-tooth ratchet mechanism. The Wera click torque wrench is accompanied with various accessories in a compact set arrangement.

Included are: Click-Torque A 6 1/4" from 2.5 to 25 Nm, 6 sockets with 1/4" drive, 11 Hex-Plus hexagon bits, Phillips head bits and TORX® bits, plus an extension and socket adaptor.

Click-Torque A 6 Set 1



	Code	EAN	
	05130110001	205643	1
		Click-Torque A 6 1x 1/4", 2,5-25 Nm	
		851/4 TZ PH 1x PH 2x50	
		867/4 Z TORX® 1x TX 15x50; 1x TX 20x50; 1x TX 25x50; 1x TX 27x50; 1x TX 30x50; 1x TX 40x50	
		840/4 Z Hex-Plus 1x 3,0x50; 1x 4,0x50; 1x 5,0x50; 1x 6,0x50	
		870/1 1x 1/4"x25 ¹⁾	
		8794 SA 1x 1/4"x75,0	
		8790 HMA 1x 6,0x23,0; 1x 7,0x23,0; 1x 8,0x23,0; 1x 10,0x23,0; 1x 12,0x23,0; 1x 13,0x23,0	
		K240 1x 50,0x240,0	

¹⁾With friction ball; for manual nut spinner sockets



Bicycle Set Torque 1

The 16-piece set from the screwdriving tool specialist Wera solves the most important screwdriving problems associated with bicycles, with reliable control of applied torque to protect sensitive components. With a click-torque wrench in the unmistakable Wera design.

Very robust design with high accuracy as per DIN EN ISO 6789-1:2017-07. Easy setting and saving of the default values. The audible and tactile snapping on reaching the scale values also facilitates the safe setting of the desired torque values.

The robust release mechanism guarantees a clearly audible and tactile trigger signal when the set torque is reached.

For clockwise torque-control and with a reversible 45-tooth ratchet. The torque wrench is extremely space-saving and supplemented with accessories that are suitable for the torque range and adapted to the most common screwed connections on bicycles; in a robust, surface-friendly textile box.

Included are: Click Torque A 5, 1/4", 2.5 - 25 Nm, 4 sockets with 1/4" drive, 7 Hex Plus hexagon bit sockets and 4 TORX® bit sockets. Sockets and bit sockets with Take it easy tool finder with colour coding by size - for easy and quick location of the required tool.

Bit sockets with holding function for extra comfortable screw-driving without the screw falling off the tool. Incredibly compact arrangement for a lot of tools in a small space.

Textile box with very high robustness and longevity. Additional surface protection through the textile outer material.

Low weight and volume for easier mobility. Bit sockets with all the benefits of Wera bit technology such as fitting accuracy, wear resistance and concentric run-out properties.

Bicycle Set Torque 1



Code	EAN		
05004180001	4013288 207685		1
		Click-Torque A 5 1x 1/4", 2,5-25 Nm	
		● 8790 HMA 1x 10,0x23,0; 1x 13,0x23,0; 1x 14,0x23,0; 1x 15,0x23,0	
		⊕ 8767 A 1x TX 10x28,0; 1x TX 20x28,0; 1x TX 25x28,0; 1x TX 30x28,0	
		○ 8740 A HF 1x 3,0x28,0; 1x 4,0x28,0; 1x 5,0x28,0; 1x 5,0x100,0; 1x 6,0x28,0; 1x 6,0x100,0; 1x 8,0x28,0	
		K240 1x 50,0x240,0	

Click-Torque B 1 torque wrench with reversible ratchet

- With 3/8" square drive, reversible ratchet, 45 teeth
- Measuring range: 10-50 Nm; precise to +/- 3% as per DIN EN ISO 6789-1:2017-07

Click-Torque B 1 torque wrench with reversible ratchet, 10-50 Nm



Code	EAN		Nm	Nm	lbf. ft.	mm	mm	
05075610001	4013288 193193	3/8"	10-50	2,5	8-36	360	140	1

Click-Torque B 2 torque wrench with reversible ratchet

- With 3/8" square drive, reversible ratchet, 45 teeth
- Measuring range: 20-100 Nm; precise to +/- 3% as per DIN EN ISO 6789-1:2017-07

Click-Torque B 2 torque wrench with reversible ratchet, 20-100 Nm



	EAN								
Code	4013288		Nm	Nm	lbf. ft.	mm	mm		
05075611001	193209	3/8"	20-100	5,0	15-73	405	140		1

Click-Torque C 1 torque wrench with reversible ratchet

- With 1/2" square drive, reversible ratchet, 45 teeth
- Measuring range: 10-50 Nm; precise to +/- 3% as per DIN EN ISO 6789-1:2017-07

Click-Torque C 1 torque wrench with reversible ratchet, 10-50 Nm



	EAN								
Code	4013288		Nm	Nm	lbf. ft.	mm	mm		
05075620001	193216	1/2"	10-50	2,5	8-36	360	140		1

Click-Torque C 2 torque wrench with reversible ratchet

- With 1/2" square drive, reversible ratchet, 45 teeth
- Measuring range: 20-100 Nm; precise to +/- 3% as per DIN EN ISO 6789-1:2017-07

Click-Torque C 2 torque wrench with reversible ratchet, 20-100 Nm



	EAN								
Code	4013288		Nm	Nm	lbf. ft.	mm	mm		
05075621001	193223	1/2"	20-100	5,0	15-73	405	140		1

Click-Torque C 3 torque wrench with reversible ratchet

- With 1/2" square drive, reversible ratchet, 45 teeth
- Measuring range: 40-200 Nm; precise to +/- 3% as per DIN EN ISO 6789-1:2017-07

Click-Torque C 3 torque wrench with reversible ratchet, 40-200 Nm



	EAN								
Code	4013288		Nm	Nm	lbf. ft.	mm	mm		
05075622001	193230	1/2"	40-200	10,0	30-146	510	140		1



Click-Torque C 3 Set 1

Click torque wrench set in the unmistakable Wera design. Very robust design with high accuracy as per DIN EN ISO 6789-1: 2017-07.

Easy setting and saving of the default values. The audible and tactile snapping on reaching the scale values also facilitates the safe setting of the desired torque values.

The robust release mechanism guarantees a clearly audible and tactile trigger signal when the set torque is reached. For clockwise torque-control and with reversible 45-tooth ratchet.

Torque wrenches and torque-compatible accessories are packed in an extremely space-saving, robust, surface-friendly textile box.

Contains: Click Torque C 3, 1/2", 40-200 Nm, 4 sockets with 1/2" drive, 7 hex plus hexagon socket and TORX® bit sockets plus extension.

Click-Torque C 3 Set 1, 40-200 Nm



Code	EAN		
05075680001	4013288 207609		1
		Click-Torque C 3 1x 1/2", 40-200 Nm	
		● 8790 HMC 1x 10,0x37,0; 1x 13,0x37,0; 1x 17,0x37,0; 1x 19,0x37,0	
		⊕ 8767 C HF 1x TX 30x60,0; 1x TX 40x60,0; 1x TX 45x60,0; 1x TX 50x60,0	
		○ 8740 C HF 1x 6,0x60,0; 1x 8,0x60,0; 1x 10,0x60,0	
		◐◑ 8794 SC 1x 1/2"x125,0	

Click-Torque C 3 set 2 for cement screwdriving, 40-200 Nm

11-piece set for fitting security-relevant cement screws with defined torque moments as per screw manufacturer instructions.

With Take it easy tool finder with colour coding and size stamping - for easy and fast location of the required tool.

- For fitting security-relevant cement screws with defined torque moments as per screw manufacturer instructions
- 8790 C Impaktor socket wrench inserts for the application with compressed air or electrically driven impact wrenches with 12.5 mm = 1/2" drive (13 mm to 21 mm)
- Click-Torque C 3 torque wrench with reversible ratchet (measuring range: 40-200 Nm; precision ± 3 % as per DIN EN ISO 6789-1:2017-07)
- 11-piece set in premium textile tool box

Click-Torque C 3 set 2 for cement screwdriving, 40-200 Nm



Code	EAN		
05075681001	4013288 217561		1
		Click-Torque C 3 1x 1/2", 40-200 Nm	
		● 8790 C Impaktor 1x 13,0x38,0; 1x 14,0x38,0; 1x 15,0x38,0; 1x 16,0x38,0; 1x 17,0x38,0; 1x 18,0x38,0; 1x 19,0x38,0; 1x 20,0x38,0; 1x 21,0x38,0	
		◐◑ 8894 SC 1x 1/2"x125,0	

Click-Torque C 4 torque wrench with reversible ratchet

- With 1/2" square drive, reversible ratchet, 45 teeth
- Measuring range: 60-300 Nm; precise to +/- 3% as per DIN EN ISO 6789-1:2017-07

Click-Torque C 4 torque wrench with reversible ratchet, 60-300 Nm



	EAN							
Code	4013288		Nm	Nm	lbf. ft.	mm	mm	
05075623001	193247	1/2"	60-300	10,0	45-220	595	140	1

Click-Torque C 5 torque wrench with reversible ratchet

- With 1/2" square drive, reversible ratchet, 45 teeth
- Measuring range: 80-400 Nm; precise to +/- 3% as per DIN EN ISO 6789-1:2017-07

Click-Torque C 5 torque wrench with reversible ratchet, 80-400 Nm



	EAN							
Code	4013288		Nm	Nm	lbf. ft.	mm	mm	
05075624001	193254	1/2"	80-400	10,0	60-295	680	140	1

Click-Torque E 1 torque wrench with reversible ratchet

- With 3/4" square drive, reversible ratchet, 45 teeth
- Measuring range: 200-1000 Nm; precise to +/- 3% as per DIN EN ISO 6789-1:2017-07

Click-Torque E 1 torque wrench with reversible ratchet, 200-1000 Nm



	EAN							
Code	4013288		Nm	Nm	lbf. ft.	mm	mm	
05075630001	193261	3/4"	200-1000	20,0	148-737	1250	140	1

Click-Torque C 2 Push R/L adjustable torque wrenches for clockwise and anti-clockwise torque-control

Click torque wrench in the unmistakable Wera design. For clockwise and anti-clockwise torque-control. Very robust design with high accuracy as per DIN EN ISO 6789-1: 2017-07. Easy setting and saving of the default value.

The audible and tactile clicks on reaching the scale values facilitate the safe setting of the desired torque value. The robust release mechanism guarantees a clearly audible and tactile release signal when the set torque is reached.

With captive 3/4" square head insert to change direction. 1/2" square head drive with socket locking.

- For clockwise and anti-clockwise torque-control thanks to the smooth reversing of the captive square head insert
- Measuring range: 20-100 Nm; precise to +/- 3% as per DIN EN ISO 6789-1:2017-07
- 45 teeth and 1/2" square head drive with socket locking
- Easy setting and saving of the desired torque value with audible and tactile clicks when reaching the scale values
- Audible and tactile release mechanism when the set torque value is reached

Click-Torque C 2 Push R/L adjustable torque wrench for clockwise and anti-clockwise torque-control, 20-100 Nm

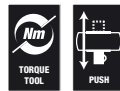

	EAN							
Code	4013288		Nm	Nm	lbf. ft.	mm	mm	
05075625001	218926	1/2"	20-100	5,0	15-73	405	140	1



Click-Torque C 3 Push R/L adjustable torque wrench for clockwise and anti-clockwise torque-control, 40-200 Nm

- Measuring range: 40-200 Nm; precise to +/- 3% as per DIN EN ISO 6789-1:2017-07
- For clockwise and anti-clockwise torque-control thanks to the smooth reversing of the captive square head insert
- 45 teeth and 1/2" square head drive with socket locking

Click-Torque C 3 Push R/L adjustable torque wrench for clockwise and anti-clockwise torque-control, 40-200 Nm



Code	EAN	□	Nm	Nm	lbf. ft.	mm	mm	
05075626001	218933	1/2"	40-200	10,0	30-146	510	140	1

Click-Torque E 1 Push R/L adjustable torque wrench for clockwise and anti-clockwise torque-control, 200-1000 Nm

- For clockwise and anti-clockwise torque-control thanks to smooth reversing of the captive square head insert
- Measuring range: 200-1000 Nm; precise to +/- 3% as per DIN EN ISO 6789-1:2017-07
- 45 teeth and 3/4" square head drive

Click-Torque E 1 Push R/L adjustable torque wrench for clockwise and anti-clockwise torque-control, 200-1000 Nm



Code	EAN	□	Nm	Nm	lbf. ft.	mm	mm	
05075631001	219053	3/4"	200-1000	20,0	148-737	1250	140	1

Click-Torque X 1 torque wrench for insert tools

Click-Torque wrench in the unmistakable, robust Wera design with high accuracy as per DIN EN ISO 6789-1: 2017-07. Easy setting and saving of the default value.

The audible and tactile clicks on reaching the scale values also facilitate the safe setting of the desired torque value. The robust release mechanism guarantees a clearly audible and tactile release signal when the set torque is reached.

For right-hand and left-hand use and with 9x12mm insert square for the insertion of insert tools.

- For 9x12 mm interchangeable insert tools.
- Measuring range: 2.5-25 Nm; precise to +/- 4% as per DIN EN ISO 6789-1:2017-07

Click-Torque X 1 torque wrench for insert tools, 2.5-25 Nm



Code	EAN	□	Nm	Nm	lbf. ft.	mm	mm	
05075651001	193773	9x12	2,5-25	1,0	1-18	283	121	1

Click-Torque X 2 torque wrench for insert tools

- For 9x12 mm interchangeable insert tools.
- Measuring range: 10-50 Nm; precise to +/- 3% as per DIN EN ISO 6789-1:2017-07

Click-Torque X 2 torque wrench for insert tools, 10-50 Nm



Code	EAN	□	Nm	Nm	lbf. ft.	mm	mm	
05075652001	193797	9x12	10-50	2,5	8-36	338	140	1

Click-Torque X 3 torque wrench for insert tools

- For 9x12 mm interchangeable insert tools.
- Measuring range: 20-100 Nm; precise to +/- 3% as per DIN EN ISO 6789-1:2017-07

Click-Torque X 3 torque wrench for insert tools, 20-100 Nm



		EAN							
Code	4013288		Nm	Nm	lb. ft.	mm	mm		
05075653001	193780	9x12	20-100	5,0	15-73	372	140	1	

Click-Torque X 4 torque wrench for insert tools

- For 14x18 mm interchangeable insert tools
- Measuring range: 40-200 Nm; precise to +/- 3% as per DIN EN ISO 6789-1:2017-07

Click-Torque X 4 torque wrench for insert tools, 40-200 Nm



		EAN							
Code	4013288		Nm	Nm	lb. ft.	mm	mm		
05075654001	193803	14x18	40-200	10,0	30-146	480	140	1	

Click-Torque X 5 torque wrench for insert tools

- For 14x18 mm interchangeable insert tools
- Measuring range: 60-300 Nm; precise to +/- 3% as per DIN EN ISO 6789-1:2017-07

Click-Torque X 5 torque wrench for insert tools, 60-300 Nm



		EAN							
Code	4013288		Nm	Nm	lb. ft.	mm	mm		
05075655001	193810	14x18	60-300	10,0	45-220	570	140	1	

Click-Torque X 6 torque wrench for insert tools

- For 14x18 mm interchangeable insert tools
- Measuring range: 80-400 Nm; precise to +/- 3% as per DIN EN ISO 6789-1:2017-07

Click-Torque X 6 torque wrench for insert tools, 80-400 Nm



		EAN							
Code	4013288		Nm	Nm	lb. ft.	mm	mm		
05075656001	193827	14x18	80-400	10,0	60-295	655	140	1	



Click-Torque XP 1 pre-set adjustable torque wrench for insert tools

Torque wrench with pre-set torque value for all applications where the same torque and repeat accuracy is required. The torque value can be changed within the metered range.

The robust release mechanism guarantees a clearly audible and tactile trigger signal when the set torque value is reached.

Square socket for interchangeable plug-in tools for clockwise and anti-clockwise torque-control.

A presetting which deviates from this value to a desired torque value within the specified metered range is possible on request.

- With square socket (9x12 mm) for interchangeable plug-in tools; clockwise and anti-clockwise torque-control
- Pre-set click torque wrench in unmistakable Wera design
- Measuring range: 2.5-25 Nm; precise to +/- 2% as per DIN EN ISO 6789-1:2017-07
- Pre-set torque values can be changed within the metered range in the test laboratory

Click-Torque XP 1 pre-set adjustable torque wrench for insert tools, 2.5-25 Nm



		EAN							
Code	4013288		Nm	Nm	lbf. ft.	mm	mm		
05075670001	206169	9x12	2,5	2,5-25	2-18	217	137	1	
05075670010 ¹⁾	206206	9x12	2,5	2,5-25	2-18	217	137	1	

¹⁾Any presetting which differs from this value, can be set to a desired torque value within the specified metered range upon request.

Click-Torque XP 2 pre-set adjustable torque wrench for insert tools

- With square socket (9x12 mm) for interchangeable plug-in tools; clockwise and anti-clockwise torque-control
- Measuring range: 10-50 Nm; precise to +/- 2% as per DIN EN ISO 6789-1:2017-07
- Pre-set torque values can be changed within the metered range in the test laboratory

Click-Torque XP 2 pre-set adjustable torque wrench for insert tools, 10-50 Nm



		EAN							
Code	4013288		Nm	Nm	lbf. ft.	mm	mm		
05075671001	206176	9x12	10,0	10-50	8-36	262	137	1	
05075671010 ¹⁾	206213	9x12	10,0	10-50	8-36	262	137	1	

¹⁾Any presetting which differs from this value, can be set to a desired torque value within the specified metered range upon request.

Click-Torque XP 3 pre-set adjustable torque wrench for insert tools

- With square socket (9x12 mm) for interchangeable plug-in tools; clockwise and anti-clockwise torque-control
- Measuring range: 15-100 Nm; precise to +/- 2% as per DIN EN ISO 6789-1:2017-07
- Pre-set torque values can be changed within the metered range in the test laboratory

Click-Torque XP 3 pre-set adjustable torque wrench for insert tools, 15-100 Nm



		EAN							
Code	4013288		Nm	Nm	lbf. ft.	mm	mm		
05075672001	206183	9x12	15,0	15-100	11-74	332	137	1	
05075672010 ¹⁾	207999	9x12	15,0	15-100	11-74	332	137	1	

¹⁾Any presetting which differs from this value, can be set to a desired torque value within the specified metered range upon request.

Click-Torque XP 4 pre-set adjustable torque wrench for insert tools

- With square socket (14x18) for interchangeable plug-in tools; clockwise and anti-clockwise torque-control
- Measuring range: 20-250 Nm; precise to +/- 2% as per DIN EN ISO 6789-1:2017-07
- Pre-set torque values can be changed within the metered range in the test laboratory

Click-Torque XP 4 pre-set adjustable torque wrench for insert tools, 20-250 Nm



		EAN							
Code	4013288		Nm	Nm	lbf. ft.	mm	mm		
05075673001	206190	14x18	20,0	20-250	15-184	457	145	1	
05075673010 ¹⁾	206220	14x18	20,0	20-250	15-184	457	145	1	

¹⁾ Any presetting which differs from this value, can be set to a desired torque value within the specified metered range upon request.

7770 Open end insert, 9x12 mm

- Square insert tool 9x12 mm
- For torque wrenches of the Click-Torque X and XP series with 9x12 mm holder
- Application: Hexagon screw heads or nuts
- With safety pin
- The chrome-vanadium steel version makes the plug-in tools suitable for heavy loads

A Form

- 05078600001
- 05078601001
- 05078602001
- 05078603001
- 05078604001
- 05078605001



B Form

- 05078606001
- 05078607001
- 05078608001
- 05078609001
- 05078610001
- 05078611001
- 05078612001



7770 Open end insert, 9x12 mm







	EAN							
Code	4013288	mm	mm	mm	mm	mm	mm	
05078600001	196101	7	39,0	22,0	22,0	5,0		1
05078601001	196095	8	39,0	22,0	22,0	5,0		1
05078602001	196088	9	39,0	22,0	22,0	5,0		1
05078603001	196071	10	39,0	22,0	22,0	5,0		1
05078604001	196064	11	39,0	22,0	22,0	5,0		1
05078605001	196057	12	39,0	22,0	22,0	5,0		1
05078606001	196040	13	41,0	24,0	30,0	7,0		1
05078607001	196033	14	41,0	24,0	30,0	7,0		1
05078608001	196026	15	41,0	24,0	30,0	7,0		1
05078609001	196019	16	41,0	24,0	30,0	7,0		1
05078610001	196002	17	41,0	24,0	30,0	7,0		1
05078611001	196118	18	41,0	24,0	30,0	7,0		1
05078612001	196125	19	41,0	24,0	30,0	7,0		1





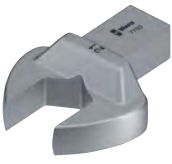















7780 Open end insert, 14x18 mm

Open end insert, for hexagon screw heads or nuts; for torque wrenches of the Click-Torque X and XP series with 14x18 mm holder.

A Form	
05078670001	
B Form	
05078671001	
05078672001	
05078673001	
05078674001	
05078675001	
05078676001	
C Form	
05078677001	
05078678001	
05078679001	
05078680001	
05078681001	
D Form	
05078682001	
05078683001	
05078684001	
05078685001	
05078686001	
05078687001	



7780 Open end insert, 14x18 mm



Code	EAN																				
05078670001	196729	13	56,0	32,0	30,0	7,0														1	
05078671001	196736	14	58,0	33,0	32,0	8,0															1
05078672001	196743	15	58,0	33,0	32,0	8,0															1
05078673001	196750	16	58,0	33,0	32,0	9,0															1
05078674001	196767	17	58,0	33,0	32,0	9,0															1
05078675001	196774	18	58,0	33,0	32,0	9,7															1
05078676001	196781	19	58,0	33,0	32,0	9,7															1
05078677001	196798	21	61,0	36,0	52,0	11,0															1
05078678001	196804	22	61,0	36,0	52,0	11,0															1
05078679001	196811	24	61,0	36,0	52,0	12,0															1
05078680001	196828	26	61,0	36,0	52,0	13,0															1
05078681001	196835	27	61,0	36,0	52,0	13,0															1
05078682001	196842	29	61,0	36,0	52,0	14,0															1
05078683001	196859	30	61,0	36,0	52,0	14,0															1
05078684001	196866	32	61,0	36,0	52,0	14,0															1
05078685001	196873	36	61,0	36,0	52,0	15,0															1
05078686001	196880	38	61,0	36,0	52,0	15,0															1
05078687001	196897	41	61,0	36,0	52,0	15,0															1





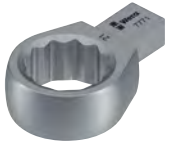

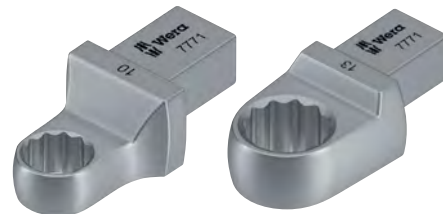

7771 Ring spanner insert, 9x12 mm

Ring spanner insert, for hexagon screw heads or nuts; for torque wrenches of the Click-Torque X and XP series with 9x12 mm holder.

A Form	
05078620001	
05078621001	
05078622001	
05078623001	
05078624001	
B Form	
05078625001	
05078626001	
05078627001	
05078628001	
05078629001	
05078630001	
05078631001	
05078632001	
C Form	
05078633001	

7771 Ring spanner insert, 9x12 mm



Code	EAN															
05078620001	196163	7	41,0	24,0	22,0	8,0										1
05078621001	196156	8	41,0	24,0	22,0	8,0										1
05078622001	196170	9	41,0	24,0	22,0	8,0										1
05078623001	196187	10	41,0	24,0	22,0	8,0										1
05078624001	196194	11	41,0	24,0	22,0	8,0										1
05078625001	196200	12	44,0	27,0	22,0	11,0										1
05078626001	196217	13	44,0	27,0	22,0	11,0										1
05078627001	196224	14	44,0	27,0	22,0	11,0										1
05078628001	196231	15	44,0	27,0	22,0	11,0										1
05078629001	196248	16	44,0	27,0	22,0	11,0										1
05078630001	196255	17	44,0	27,0	22,0	11,0										1
05078631001	196262	18	44,0	27,0	22,0	11,0										1
05078632001	196279	19	44,0	27,0	22,0	11,0										1
05078633001	196286	21	51,0	34,0	33,0	15,0										1

7781 Ring spanner insert, 14x18 mm

Ring spanner insert, for hexagon screw heads or nuts; for torque wrenches of the Click-Torque X and XP series with 14x18 mm holder.

A Form

05078690001
05078691001
05078692001



B Form

05078693001
05078694001
05078695001
05078696001
05078697001
05078698001
05078699001



C Form

05078700001
05078701001
05078702001
05078703001
05078704001
05078705001



7781 Ring spanner insert, 14x18 mm



Code	EAN							
05078690001	196132	13	62,0	37,0	30,0	11,0		1
05078691001	196576	14	62,0	37,0	30,0	11,0		1
05078692001	196583	15	62,0	37,0	30,0	11,0		1
05078693001	196590	16	64,0	39,0	28,0	12,0		1
05078694001	196606	17	64,0	39,0	28,0	12,0		1
05078695001	196620	18	64,0	39,0	28,0	12,0		1
05078696001	196637	19	64,0	39,0	28,0	12,0		1
05078697001	196644	21	64,0	39,0	28,0	12,0		1
05078698001	196613	22	64,0	39,0	28,0	12,0		1
05078699001	196651	24	64,0	39,0	28,0	12,0		1
05078700001	196668	27	81,0	56,0	53,0	21,0		1
05078701001	196675	30	81,0	56,0	53,0	21,0		1
05078702001	196682	32	81,0	56,0	53,0	21,0		1
05078703001	196699	34	81,0	56,0	53,0	21,0		1
05078704001	196705	36	81,0	56,0	53,0	21,0		1
05078705001	196712	41	81,0	56,0	53,0	21,0		1

7772 A Ratchet insert, reversible, 9x12 mm

Ratchet insert, reversible, for 1/4" square socket wrench inserts and 1/4" connecting parts with square drive; for torque wrenches of the Click-Torque X and XP series with 9x12 mm holder.

7772 A Ratchet insert, reversible, 9x12 mm



	EAN							
Code	4013288		mm	mm	mm	mm		
05078635001	196347	1/4"	49,0	32,0	28,0	15,0		1

7772 B Ratchet insert, reversible, 9x12 mm

Ratchet insert, reversible, for 3/8" square socket wrench inserts and 3/8" connecting parts with square drive; for torque wrenches of the Click-Torque X and XP series with 9x12 mm holder.

7772 B Ratchet insert, reversible, 9x12 mm



	EAN							
Code	4013288		mm	mm	mm	mm		
05078636001	196446	3/8"	52,0	35,0	35,0	21,0		1

7772 C Ratchet insert, reversible, 9x12 mm

Ratchet insert, reversible, for 1/2" square socket wrench inserts and 1/2" connecting parts with square drive; for torque wrenches of the Click-Torque X and XP series with 9x12 mm holder.

7772 C Ratchet insert, reversible, 9x12 mm



	EAN							
Code	4013288		mm	mm	mm	mm		
05078637001	196453	1/2"	58,0	41,0	42,0	23,0		1



7782 C Ratchet insert, reversible, 14x18 mm

Ratchet insert, reversible, for 1/2" square socket wrench inserts and 1/2" connecting parts with square drive; for torque wrenches of the Click-Torque X and XP series with 14x18 mm holder.

7782 C Ratchet insert, reversible, 14x18 mm



	EAN								
Code	4013288		mm	mm	mm	mm	mm		
05078707001	196552	1/2"	66,0	41,0	42,0	23,0			1

7782 E Ratchet insert, reversible, 14x18 mm

Ratchet insert, reversible, for 3/4" square socket wrench inserts and 3/4" connecting parts with square drive; for torque wrenches of the Click-Torque X and XP series with 14x18 mm holder.

7782 E Ratchet insert, reversible, 14x18 mm



	EAN								
Code	4013288		mm	mm	mm	mm	mm		
05078708001	196569	3/4"	90,0	65,0	65,0	36,0			1

7773 A Square drive insert, 9x12 mm

Square drive insert, for 1/4" square socket wrench inserts and 1/4" connecting parts with square drive; for torque wrenches of the Click-Torque X and XP series with 9x12 mm holder.

7773 A Square drive insert, 9x12 mm



	EAN								
Code	4013288		mm	mm					
05078200001	023742	1/4"	44,0	28,0	21,0	14,0			1

7773 B Square drive insert, 9x12 mm



	EAN								
Code	4013288		mm	mm					
05078205001	023759	3/8"	44,0	28,0	21,0	14,0			1

7773 C Square drive insert, 9x12 mm



	EAN								
Code	4013288		mm	mm	mm	mm			
05078210001	023766	1/2"	44,0	28,0	21,0	14,0			1

7783 C Square drive insert, 14x18 mm

Square drive insert, for 1/2" square socket wrench inserts and 1/2" connecting parts with square drive; for torque wrenches of the Click-Torque X and XP series with 14x18 mm holder.

7783 C Square drive insert, 14x18 mm



	EAN							
Code	4013288		mm	mm				
05078345001	024183	1/2"	65,0	40,0	30,0	18,0		1

7783 E Push-through square insert tool, 14x18 mm

Square drive insert, for 3/4" square socket wrench inserts and 3/4" connecting parts with square drive; for torque wrenches of the Click-Torque X and XP series with 14x18 mm holder.

7783 E Push-through square insert tool, 14x18 mm



	EAN							
Code	4013288		mm	mm	mm	mm		
05078710001	196460	3/4"	70,0	45,0	40,0	25,0		1

7774/1 Bit adapter insert, 1/4", 9x12 mm

Bit adapter insert, 1/4"; for torque wrenches of the Click-Torque X and XP series with 9x12 mm holder.

7774/1 Bit adapter insert, 1/4", 9x12 mm



	EAN							
Code	4013288		mm	mm	mm	mm		
05078640001	196316	1/4"	42,0	25,0	22,0	12,5		1

7774/2 Bit adapter insert, 5/16", 9x12 mm

Bit adapter insert, 5/16"; for torque wrenches of the Click-Torque X and XP series with 9x12 mm holder.

7774/2 Bit adapter insert, 5/16", 9x12 mm



	EAN							
Code	4013288		mm	mm	mm	mm		
05078641001	196309	5/16"	42,0	25,0	22,0	12,5		1

7774/3 Bit adapter insert, 5/16", 14x18 mm

Bit adapter insert, 5/16"; for torque wrenches of the Click-Torque X and XP series with 14x18 mm holder.

7774/3 Bit adapter insert, 5/16", 14x18 mm



	EAN							
Code	4013288		mm	mm	mm	mm		
05078642001	196293	5/16"	58,0	33,0	30,0	13,0		1



7775 Open ring spanner insert, 9x12 mm

Open ring spanner insert, for hexagon screw heads or nuts; for torque wrenches of the Click-Torque X and XP series with 9x12 mm holder.

A Form

- 05078650001
- 05078651001
- 05078652001
- 05078653001
- 05078654001
- 05078655001



B Form

- 05078656001
- 05078657001
- 05078658001



7775 Open ring spanner insert, 9x12 mm



	EAN							
Code	4013288	mm	mm	mm	mm	mm		
05078650001	196330	10	44,0	27,0	22,0	11,0		1
05078651001	196361	11	44,0	27,0	22,0	11,0		1
05078652001	196378	12	44,0	27,0	22,0	11,0		1
05078653001	196385	13	44,0	27,0	22,0	11,0		1
05078654001	196392	14	44,0	27,0	22,0	11,0		1
05078655001	196408	17	44,0	27,0	22,0	11,0		1
05078656001	196415	18	49,0	32,0	33,0	15,0		1
05078657001	196422	19	49,0	32,0	33,0	15,0		1
05078658001	196439	22	49,0	32,0	33,0	15,0		1

7776 External TORX® insert, 9x12 mm

External TORX® insert; for torque wrenches of the Click-Torque X and XP series with 9x12 mm holder.

A Form

- 05078660001
- 05078661001
- 05078662001
- 05078663001



B Form

- 05078664001



7776 External TORX® insert, 9x12 mm



	EAN							
Code	4013288		mm	mm	mm	mm		
05078660001	195968	TX 6	40,0	23,0	22,0	8,0		1
05078661001	195975	TX 8	40,0	23,0	22,0	8,0		1
05078662001	195982	TX 10	40,0	23,0	22,0	8,0		1
05078663001	195999	TX 12	40,0	23,0	22,0	8,0		1
05078664001	196149	TX 14	45,0	28,0	22,0	11,0		1

7786 External TORX® insert, 14x18 mm

External TORX® insert; for torque wrenches of the Click-Torque X and XP series with 14x18 mm holder.

A Form 05078714001 05078715001	
B Form 05078716001 05078717001	

7786 External TORX® insert, 14x18 mm



	EAN						
Code	4013288		mm	mm	mm	mm	
05078714001	196507	TX 14	37,0	62,0	30,0	11,0	1
05078715001	196514	TX 18	37,0	62,0	30,0	11,0	1
05078716001	196521	TX 20	40,0	65,0	32,0	12,0	1
05078717001	196538	TX 24	40,0	65,0	32,0	12,0	1

7779/1 Adapter insert, 9x12 mm

Adapter insert for the use of square plug-in tools 14x18 mm in torque wrenches with internal square 9x12 mm; for torque wrenches of the Click-Torque X and XP series with 9x12 mm holder.

7779/1 Adapter insert, 9x12 mm



	EAN						
Code	4013288	mm	mm	mm	mm	mm	
05078666001	196323	14x18	9x12	49,0	33,0	32,0	1

7779/2 Adapter insert, 14x18 mm

Adapter insert for the use of square plug-in tools 9x12 mm in torque wrenches with internal square 14x18 mm; for torque wrenches of the Click-Torque X and XP series with 14x18 mm holder.

7779/2 Adapter insert, 14x18 mm



	EAN						
Code	4013288	mm	mm	mm	mm	mm	
05078667001	196545	9x12	14x18	52,0	27,0	28,0	1

7790/1 Push-fit weld-on adapter, 9x12 mm

Push-fit weld-on adapter; for torque wrenches of the Click-Torque X series with 9x12 mm holder.

7790/1 Push-fit weld-on adapter, 9x12 mm



	EAN						
Code	4013288	mm	mm	mm	mm		
05078720001	196354	24,0	8,0	22,0	14,0		1

7790/2 Push-fit weld-on adapter, 14x18 mm

Push-fit weld-on adapter; for torque wrenches of the Click-Torque X and XP series with 14x18 mm holder.

7790/2 Push-fit weld-on adapter, 14x18 mm



	EAN						
Code	4013288	mm	mm	mm	mm		
05078721001	196477	38,0	13,0	31,0	22,0		1



Click-Torque collar

The collar prevents the handle of the Click-Torque torque wrench from touching the ground. Dirt and damage are avoided when putting down the tool while working.

Also prevents the tool from rolling away, and it serves to fix the Click-Torque torque wrench in the storage/transport box. The collar can be easily attached to the torque wrench tube and is removable.

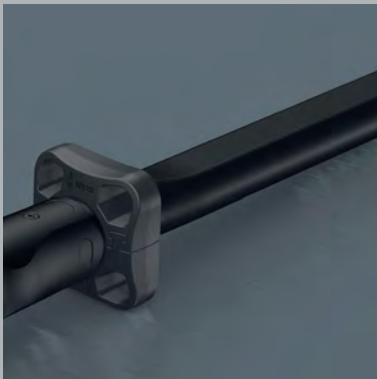

7762 Click-Torque collar M3

Click-Torque collar as an accessory for Click-Torque Torque wrenches B 1, B 2, C 1, C 2, C 3, C 4, X 2, X 3, X 4, X 5, XP 4, Click-Torque Push R/L C 2 and Click-Torque Push R/L C 3.

7762 Click-Torque collar M3



	EAN							
Code	4013288	mm	mm	mm				
05078709001	211767	55,0	70,0	21,5				1

7761 Click-Torque collar M4

Click-Torque collar as an accessory for Click-Torque Torque wrenches C 5 and X 6.

7761 Click-Torque collar M4



	EAN							
Code	4013288	mm	mm	mm				
05078706001	211750	55,0	68,0	21,5				1

7763 Click-Torque collar M5

Click-Torque collar as an accessory for Click-Torque Torque wrench E 1 and Click-Torque Push R/L E 1.

7763 Click-Torque collar M5



	EAN							
Code	4013288	mm	mm	mm				
05078711001	211774	73,0	88,0	27,0				1

Safe-Torque A 1 torque wrench with 1/4" square head drive, 2-12 Nm

Torque wrench with slide-over mechanism. Once the set torque has been reached, the tool cannot be overtightened, so that excessive torque cannot be applied.

Setting range of 2 to 12 Nm for controlled clockwise and counterclockwise torque operation. Easy setting and saving of the default value: The audible and tactile clicks on reaching the scale values facilitate the safe setting of the desired torque value. With Torque Lock function for use as a standard ratchet without torque function.

Max. breaking torque of the 1/4" square head as per DIN 3122. The return angle of only 5° allows the ratchet to be used even in confined spaces and therefore also for applications with angles of rotation.

- Slip-over release mechanism – the set torque can never be overtightened
- Torque Lock function: The torque function can be deactivated and the tool can then be used as a standard ratchet for high loosening moments and for applications with defined angles of rotation
- For controlled clockwise and counterclockwise torque operation – tightening and loosening with or without torque
- Easy setting and saving of the desired torque value with audible and tactile clicks when reaching the scale values
- Comfortable working thanks to a small release angle of only 30°
- 1/4" square head drive with socket locking

Safe-Torque A 1 torque wrench with 1/4" square head drive, 2-12 Nm



Code	EAN	Drive	Nm	Nm	lbf. ft.	mm	mm	Box
0507580001	223012	1/4"	2-12	0,10	2-9	244	94	1

Safe-Torque A 2 torque wrench with 1/4" hexagon drive, 2-12 Nm

- 1/4" hexagon drive for the use of 1/4" bits

Safe-Torque A 2 torque wrench with 1/4" hexagon drive, 2-12 Nm



Code	EAN	Drive	Nm	Nm	lbf. ft.	mm	mm	Box
05075801001	223036	1/4"	2-12	0,10	2-9	244	94	1

Safe-Torque A 1 Set 1, 1/4" square head drive, 2-12 Nm

10-piece 1/4" torque wrench set in a robust textile box; torque wrench with slide-over mechanism. Once the set torque has been reached, the tool cannot be overtightened, so that excessive torque cannot be applied.

Setting range of 2 to 12 Nm for controlled clockwise and counterclockwise torque operation. Easy setting and saving of the default value: The audible and tactile clicks on reaching the scale values facilitate the safe setting of the desired torque value.

The Torque Lock function allows use as a standard ratchet without torque function. Thus also usable for applications with angles of rotation. Max. breaking torque of the 1/4" square head as per DIN 3122. The return angle of only 5° allows the ratchet to be used even in confined spaces.

Included are: Safe-Torque A 1 torque wrench, 1/4" square head, 2-12 Nm, 8 sockets with 1/4" drive and one short extension.

- 1/4" square head drive with socket locking

Safe-Torque A 1 Set 1, 1/4" square head drive, 2-12 Nm



Code	EAN	Contents	Box
05075830001	223005	1x Safe-Torque A 1 1x 1/4", 2-12 Nm	1
		8790 HMA 1x 5,5x23,0; 1x 6,0x23,0; 1x 7,0x23,0; 1x 8,0x23,0; 1x 10,0x23,0; 1x 11,0x23,0; 1x 12,0x23,0; 1x 13,0x23,0	
		8794 SA 1x 1/4"x75,0	
		Hook and Loop Fastener Strip 70 1x 50,0x240,0	



Safe-Torque A 1 Imperial Set 1, 1/4" square head drive, 2-12 Nm

10-piece 1/4" torque wrench set in a robust textile box; torque wrench with slide-over mechanism. Once the set torque has been reached, the tool cannot be overtightened, so that excessive torque cannot be applied.

Setting range of 2 to 12 Nm for controlled clockwise and counterclockwise torque operation. Easy setting and saving of the default value: The audible and tactile clicks on reaching the scale values facilitate the safe setting of the desired torque value.

The Torque Lock function allows use as a standard ratchet without torque function. Thus also usable for applications with angles of rotation. Max. breaking torque of the 1/4" square head as per DIN 3122. The return angle of only 5° allows the ratchet to be used even in confined spaces.

Included are: Safe-Torque A 1 torque wrench, 1/4" square head, 2-12 Nm, 8 sockets with 1/4" drive and one short extension.

- 1/4" square head drive with socket locking

Safe-Torque A 1 Imperial Set 1, 1/4" square head drive, 2-12 Nm



Code	EAN		
05075831001	4013288 223074		1
		<input type="checkbox"/> Safe-Torque A 1 1x 1/4", 2-12 Nm	
		<input checked="" type="checkbox"/> 8790 HMA 1x 3/16"x23,0; 1x 7/32"x23,0; 1x 1/4"x23,0; 1x 9/32"x23,0; 1x 5/16"x23,0; 1x 3/8"x23,0; 1x 7/16"x23,0; 1x 1/2"x23,0	
		<input checked="" type="checkbox"/> 8794 SA 1x 1/4"x75,0	
		Hook and Loop Fastener Strip 70 1x 50,0x240,0	

Safe-Torque A 2 Set 1, 1/4" hexagonal, 2-12 Nm

23-piece set; in surface-friendly, compact and extremely robust textile box. Small size and low weight for better mobility.

1 Safe-Torque A 2 torque wrench with 1/4" hexagonal drive, measuring range 2-12 Nm; for controlled clockwise and counterclockwise torque operation; tightening and loosening with or without torque, disengageable torque function (Torque Lock function); 72 teeth; low return angle of 5°; easy setting and saving of the desired torque value, with audible and tactile locking when the scale values are reached, slip-over release mechanism when the set torque is reached; ergonomic 2-component handle; 9 Zyklop sockets, 12 bits (1/4", 50 mm long), one connector for sockets (1/4" external hexagonal to 1/4" external square head).

- 1/4" hexagon drive for the use of 1/4" bits
- Use of 1/4" sockets also possible with the Wera adaptor 870/1

Safe-Torque A 2 Set 1, 1/4" hexagonal, 2-12 Nm



Code	EAN		
05075832001	4013288 223043		1
		<input checked="" type="checkbox"/> Safe-Torque A 2 1x 1/4", 2-12 Nm	
		<input checked="" type="checkbox"/> 8790 HMA 1x 5,5x23,0; 1x 6,0x23,0; 1x 7,0x23,0; 1x 8,0x23,0; 1x 9,0x23,0; 1x 10,0x23,0; 1x 11,0x23,0; 1x 12,0x23,0; 1x 13,0x23,0	
		<input type="checkbox"/> 870/1 1x 1/4"x25 ¹⁾	
		<input checked="" type="checkbox"/> 851/4 Z 1x PH 2x50	
		<input checked="" type="checkbox"/> 867/4 Z TORX® 1x TX 10x50; 1x TX 15x50; 1x TX 20x50; 1x TX 25x50; 1x TX 27x50; 1x TX 30x50	
		<input checked="" type="checkbox"/> 840/4 Z 1x 2,5x50; 1x 3,0x50; 1x 4,0x50; 1x 5,0x50; 1x 6,0x50	
		Hook and Loop Fastener Strip 240 1x 50,0x240,0	

¹⁾ With friction ball; for manual nut spinner sockets

101 Soft-faced hammer with nylon head sections

The hammer head is made out of nylon. Suitable for sheet metal and renovation work as well as for tent, hall and fair booth construction jobs.

101 Soft-faced hammer with nylon head sections



	EAN						
Code	4013288	#	mm	mm	mm		
05000305001	001351	1	23,0	76,0	250,0		2
05000310001	001368	2	28,0	87,0	265,0		2
05000315001	001375	3	33,0	96,0	280,0		2
05000320001	001382	4	36,0	102,0	290,0		2
05000325001	001399	5	41,0	108,0	320,0		2
05000330001	001405	6	51,0	117,0	340,0		2
05000335001	001412	7	61,0	131,0	380,0		2

102 Soft-faced hammer with urethane head sections

The hammer head is made out of semi-hard urethane. Suitable for car body, engineering and automotive applications.

102 Soft-faced hammer with urethane head sections



	EAN						
Code	4013288	#	mm	mm	mm		
05000505001	001498	1	23,0	76,0	250,0		2
05000510001	001504	2	28,0	87,0	265,0		2
05000515001	001511	3	33,0	96,0	280,0		2
05000520001	001528	4	36,0	102,0	290,0		2
05000525001	001535	5	41,0	108,0	320,0		2
05000530001	001542	6	51,0	117,0	340,0		2
05000535001	001559	7	61,0	131,0	380,0		2

100 S Replacement ashwood handles for hammers 100, 101, 102

Handles for hammers 100, 101, 102 out of best-quality ash wood.

100 S Replacement ashwood handles for hammers 100, 101, 102



	EAN						
Code	4013288	#	mm				
05000205001	001283	1	250,0				1
05000210001	001290	2	265,0				1
05000215001	001306	3	280,0				1
05000220001	001313	4	290,0				1
05000225001	001320	5	320,0				1
05000230001	001337	6	340,0				1
05000235001	001344	7	380,0				1

100 L Replacement head sections out of Cellidor for hammer 100

Interchangeable soft-face heads out of cellidor for demanding repair and maintenance applications.

100 L Replacement head sections out of Cellidor for hammer 100



	EAN						
Code	4013288	#	mm				
05000105001	001214	1	23,0				10
05000110001	001221	2	28,0				10
05000115001	001238	3	33,0				10
05000120001	001245	4	36,0				10
05000125001	001252	5	41,0				10
05000130001	001269	6	51,0				10
05000135001	001276	7	61,0				10

101 L Replacement head sections out of nylon for hammer 101

Interchangeable soft-face heads out of nylon for sheet metal and renovation work as well as for tent, hall and fair booth construction jobs.

101 L Replacement head sections out of nylon for hammer 101



	EAN						
Code	4013288	#	mm				
05000405001	001429	1	23,0				10
05000410001	001436	2	28,0				10
05000415001	001443	3	33,0				10
05000420001	001450	4	36,0				10
05000425001	001467	5	41,0				10
05000430001	001474	6	51,0				10
05000435001	001481	7	61,0				10

102 L Replacement head sections out of urethane for hammer 102

Interchangeable soft-face heads out of semi-hard urethane for car body, engineering and automotive applications.

102 L Replacement head sections out of urethane for hammer 102



	EAN						
Code	4013288	#	mm				
05000605001	001566	1	23,0				10
05000610001	001573	2	28,0				10
05000615001	001580	3	33,0				10
05000620001	001597	4	36,0				10
05000625001	001603	5	41,0				10
05000630001	001610	6	51,0				10
05000635001	001627	7	61,0				10

TORQUE Test Values



Slotted Tools

Drives: DIN ISO 2380, VSM 35601.
TORQUE values evaluated in test gages according to DIN ISO 2380 on TORQUE testing equipment.



Hexagon Tools

Drives: DIN ISO 2936. TORQUE values evaluated in test gages according to DIN ISO 2936 on TORQUE testing equipment.



PH and PZ Tools

Drives: DIN 5260, ISO 8764 and SMS-SS 1687.
TORQUE values evaluated in test gages according to DIN 5261, ISO 8764 on TORQUE testing equipment.



Tools with TORQ-SET® drive

TORQUE values evaluated with testing gages of Phillips Screw Company, licensor of TORQ-SET®, on TORQUE testing equipment.

a x b mm	TORQUE in Nm (min)	
	handuse	poweruse
0,3 x 2,0	0,18	0,20
0,4 x 2,0	0,30	0,35
0,4 x 2,5	0,40	0,45
0,5 x 3,0	0,70	0,80
0,5 x 3,5	0,90	0,98
0,6 x 3,5	1,30	1,40
0,6 x 4,0	1,40	1,61
0,6 x 4,5	-	1,80
0,8 x 4,0	2,60	2,90
0,8 x 4,5	2,88	
0,8 x 5,0	3,20	3,58
0,8 x 5,5	3,50	3,90
1,0 x 5,5	5,50	6,20
1,0 x 6,5	6,50	7,28
1,0 x 7,0	7,0	7,80
1,2 x 6,5	9,40	10,50
1,2 x 7,0	10,0	11,28
1,2 x 8,0	11,5	12,90
1,4 x 9,0	17,6	19,70
1,5 x 13	29	32
1,6 x 8,0	20,5	22,9
1,6 x 9,0	23	25
1,6 x 10	25,6	28,7
2,0 x 12	48,0	53
2,0 x 13	52	58
2,5 x 14	87	98
2,5 x 16	100	112
3,0 x 18	162	181

SW (mm)	TORQUE in Nm (min)
0,7	0,08
0,9	0,18
1,3	0,53
1,5	0,82
2,0	1,9
2,5	3,8
3	6,6
3,5	11
4	16
4,5	24
5	30
6	52
7	78
8	120
9	180
10	220
11	295
12	370
13	480
14	590
17	1000
19	1000
22	1000
24	1000
27	1000

TORQUE in Nm (min)	TORQUE in Nm (min)	
	handuse	poweruse
0	1,0	1,0
1	3,5	3,9
2	8,2	10,3
3	19,5	32,0
4	38,0	88,7



TORQUE in Nm (min)	TORQUE in Nm (min)	
	Bits	Screw- drivers
2	1,1	1,1
3	1,7	1,7
4	2,8	2,8
5	4,0	4,0
6	5,1	5,1
8	8,5	8,5
10	11,3	11,3
1/4"	28	17
5/16"	56	28
3/8"	102	62
7/16"	147	
1/2"	249	
9/16"	271	
5/8"	339	

Important device:

After TORQUE testing with the minimum value, screwdrivers shall not show any deformation or injuries at the tip.

TORQUE in Nm (min.)	TORX®			TORX PLUS®		
	Bit	Resis-Bit	Screw- driver	Bit	Resis-Bit	Screw- drivers
1	0,10	-	0,08	0,11		
2	0,14	-	0,12	0,16		
3	0,25	-	0,21	0,28		
4	0,37	-	0,31	0,44		
5	0,51	-	0,43	0,61		
6	0,91	-	0,75	1,11		0,92
7	1,7	1,4	1,4	2,10		1,68
8	2,6	2,2	2,2	3,21	2,5	2,79
9	3,4	2,9	2,8	4,19	3,3	3,49
10	4,5	3,8	3,7	5,42	4,3	4,47
15	7,7	6,5	6,4	9,62	7,3	8,06
20	12,7	10,8	10,5	16,15	11,9	13,41
25	19,0	16,1	15,9	23,50	17,4	19,58
27	26,9	22,9	22,5	34,62	25,1	28,95
30	37,4	31,8	31,1	47,18	33,5	39,34
40	65,1	55,3	54,1	82,08	59,4	68,40
45	104	88	86	137,38	97,3	114,44
50	159	135	132	194,54	152,4	162,14
55	257	218	218	352,10	291,5	299,25
60	445	379	379	566,11	483,0	481,24
70	701	596	600	910,40	713,3	773,91



Dimensions Of Profiles

TORX® Recess Screws

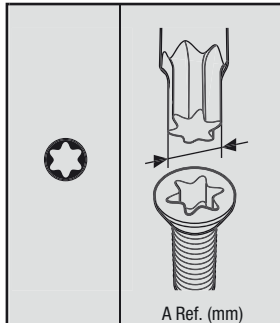

	A Ref. (mm)
TX 1	0,84
TX 2	0,94
TX 3	1,12
TX 4	1,30
TX 5	1,37
TX 6	1,65
TX 7	1,97
TX 8	2,30
TX 9	2,48
TX 10	2,72
TX 15	3,26
TX 20	3,84
TX 25	4,40
TX 27	4,96
TX 30	5,49
TX 40	6,60
TX 45	7,77
TX 50	8,79
TX 55	11,17
TX 60	13,20
TX 70	15,49

TORX PLUS® Recess Screws

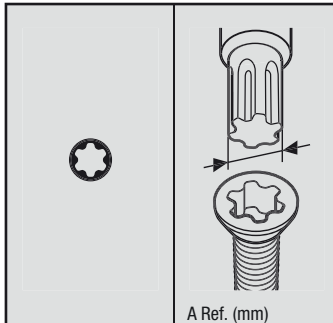

	A Ref. (mm)
1 IP	0,84
2 IP	0,95
3 IP	1,13
4 IP	1,29
5 IP	1,41
6 IP	1,69
7 IP	1,97
8 IP	2,29
9 IP	2,48
10 IP	2,72
15 IP	3,25
20 IP	3,84
25 IP	4,39
27 IP	4,95
30 IP	5,49
40 IP	6,60
45 IP	7,77
50 IP	8,79
55 IP	11,16
60 IP	13,20
70 IP	15,48

TORQ-SET® Recess Screws

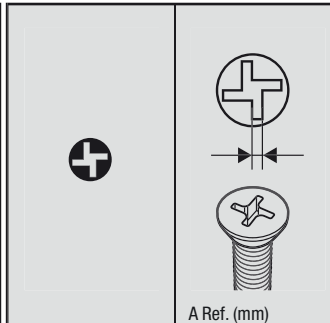

	A Ref. (mm)
0	0,43
1	0,43
2	0,43
3	0,48
4	0,56
5	0,63
6	0,71
8	0,84
10	0,96
1/4"	1,27
5/16"	1,60
3/8"	1,90
7/16"	2,23
1/2"	2,54

TRI-WING® Recess Screws

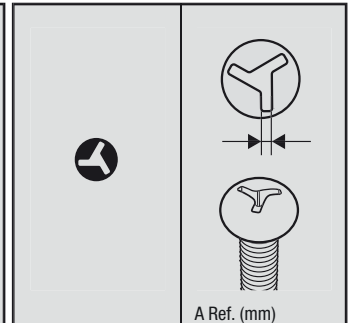

	A Ref. (mm)
0	0,45
1	0,57
2	0,75
3	0,95
4	1,08
5	1,23
6	1,54
7	1,87
8	2,17
9	2,48
10	2,78

XZN Recess Screws

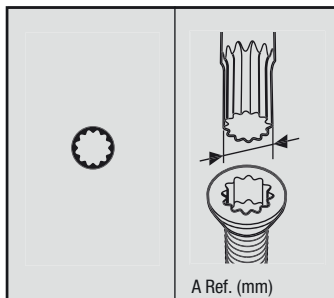

	A Ref. (mm)
M 4	3,83
M 5	4,80
M 6	6,00
M 8	7,20
M 10	9,60
M 12	11,41
M 14	13,22
M 16	15,63
M 18	16,85
M 20	19,25

Square Recess Screws

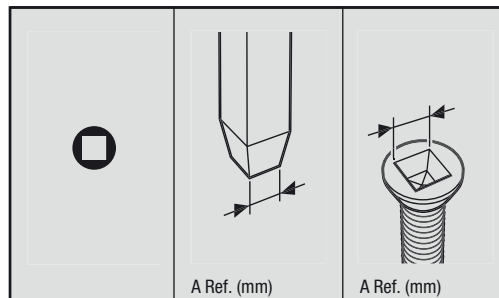

	A Ref. (mm)	A Ref. (mm)
00	1,27	1,4
0	1,78	2
1	2,31	2,5
2	2,85	3,1
3	3,37	3,7
4	4,84	5,1

Spanner Recess Screws

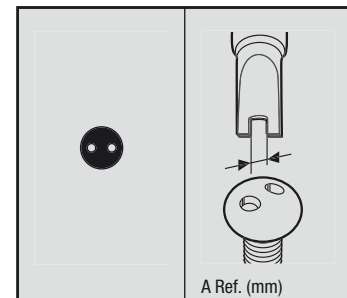

	A Ref. (mm)
4	1,52
6	2,41
8	2,79
10	3,30



TORQUE Conversion Table

Conversion Units	SI Units			Metric scale		USA GB scale		
	cNm	dNm	Nm	cmkg	mkg	ft.lb	in.lb	in.oz
1 cNm =	1	0,1	0,01	0,1020	0,0010	0,0074	0,0885	1,4161
1 dNm =	10	1	0,1	1,0197	0,0102	0,0738	0,8851	14,1612
1 Nm =	100	10	1	10,1972	0,1020	0,7376	8,8508	141,6123
1 cmkg =	9,8067	0,9807	0,0981	1	0,0100	0,0723	0,8680	13,8874
1 mkg =	980,6650	98,0665	9,8067	100	1	7,2330	86,7964	1388,7422
1 ft.lb =	135,5818	13,5581	1,3558	13,8255	0,1383	1	12	192
1 in.lb =	11,2985	1,1298	0,1130	1,1521	0,0115	0,0833	1	16
1 in. oz =	0,7062	0,0706	0,0071	0,0720	0,0007	0,0052	0,0625	1

Example 1
 1 Nm = 0,102 mkg
 17,4 Nm = 17,4 x 0,102 mkg
 17,4 Nm = 1,775 mkg

Example 2
 1 mkg = 9,8067 Nm
 12,5 mkg = 12,5 x 9,8067 Nm
 12,5 mkg = 122,58 Nm

Conversion Nm in mkg											1 Nm = 0,10197 mkg
Nm	0	1	2	3	4	5	6	7	8	9	
0	0,00	0,10	0,20	0,31	0,41	0,51	0,61	0,71	0,82	0,92	
10	1,02	1,12	1,22	1,33	1,43	1,53	1,63	1,73	1,84	1,94	
20	2,04	2,14	2,24	2,35	2,45	2,55	2,65	2,75	2,86	2,96	
30	3,06	3,16	3,26	3,37	3,47	3,57	3,67	3,77	3,87	3,98	
40	4,08	4,18	4,28	4,38	4,49	4,59	4,69	4,79	4,89	5,00	
50	5,10	5,20	5,30	5,40	5,51	5,61	5,71	5,81	5,91	6,02	
60	6,12	6,22	6,32	6,42	6,53	6,63	6,73	6,83	6,93	7,04	
70	7,14	7,24	7,34	7,44	7,55	7,65	7,75	7,85	7,95	8,06	
80	8,16	8,26	8,36	8,46	8,57	8,67	8,77	8,87	8,97	9,08	
90	9,18	9,28	9,38	9,48	9,59	9,69	9,79	9,89	9,99	10,10	
100	10,20	10,30	10,40	10,50	10,60	10,71	10,81	10,91	11,01	11,11	

Conversion mkg in Nm											1 mkg = 9,80665 Nm
mkg	0	1	2	3	4	5	6	7	8	9	
0	0,00	9,81	19,61	29,42	39,23	49,03	58,84	68,65	78,45	88,26	
10	98,07	107,87	117,68	127,49	137,29	147,10	156,91	166,71	176,52	186,33	
20	196,13	205,94	215,75	225,55	235,36	245,17	254,97	264,78	274,59	284,39	
30	294,20	304,01	313,81	323,62	333,43	343,23	353,04	362,85	372,65	382,46	
40	392,27	402,07	411,88	421,69	431,49	441,30	451,11	460,91	470,72	480,53	
50	490,33	500,14	509,95	519,75	529,56	539,37	549,17	558,98	568,79	578,59	
60	588,40	598,21	608,01	617,82	627,63	637,43	647,24	657,05	666,85	676,66	
70	686,47	696,27	706,08	715,89	725,69	735,50	745,31	755,11	764,92	774,73	
80	784,53	794,34	804,15	813,95	823,76	833,57	843,37	853,18	862,99	872,79	
90	882,60	892,41	902,21	912,02	921,83	931,63	941,44	951,25	961,05	970,86	
100	980,67	990,47	1000,28	1010,08	1019,89	1029,70	1039,50	1049,31	1059,12	1068,92	

Conversion Nm in ft.lb											1 Nm = 0,73756 ft.lb
Nm	0	1	2	3	4	5	6	7	8	9	
0	0,00	0,74	1,48	2,21	2,95	3,69	4,43	5,16	5,90	6,64	
10	7,38	8,11	8,85	9,59	10,33	11,06	11,80	12,54	13,28	14,01	
20	14,75	15,49	16,23	16,96	17,70	18,44	19,18	19,91	20,65	21,39	
30	22,13	22,86	23,60	24,34	25,08	25,81	26,55	27,29	28,03	28,76	
40	29,50	30,24	30,98	31,72	32,45	33,19	33,93	34,67	35,40	36,14	
50	36,88	37,62	38,35	39,09	39,83	40,57	41,30	42,04	42,78	43,52	
60	44,25	44,99	45,73	46,47	47,20	47,94	48,68	49,42	50,15	50,89	
70	51,63	52,37	53,10	53,84	54,58	55,32	56,05	56,79	57,53	58,27	
80	59,00	59,74	60,48	61,22	61,96	62,69	63,43	64,17	64,91	65,64	
90	66,38	67,12	67,86	68,59	69,33	70,07	70,81	71,54	72,28	73,02	
100	73,76	74,49	75,23	75,97	76,71	77,44	78,18	78,92	79,66	80,39	

Conversion ft.lb in Nm											1 ft.lb = 1,35581 Nm
ft.lb	0	1	2	3	4	5	6	7	8	9	
0	0,00	1,36	2,71	4,07	5,42	6,78	8,13	9,49	10,85	12,20	
10	13,56	14,91	16,27	17,63	18,98	20,34	21,69	23,05	24,40	25,76	
20	27,12	28,47	29,83	31,18	32,54	33,90	35,25	36,61	37,96	39,32	
30	40,67	42,03	43,39	44,74	46,10	47,45	48,81	50,16	51,52	52,88	
40	54,23	55,59	56,94	58,30	59,66	61,01	62,37	63,72	65,08	66,43	
50	67,79	69,15	70,50	71,86	73,21	74,57	75,93	77,28	78,64	79,99	
60	81,35	82,70	84,06	85,42	86,77	88,13	89,48	90,84	92,20	93,55	
70	94,91	96,26	97,62	98,97	100,33	101,69	103,04	104,40	105,75	107,11	
80	108,46	109,82	111,18	112,53	113,89	115,24	116,60	117,96	119,31	120,67	
90	122,02	123,38	124,73	126,09	127,45	128,80	130,16	131,51	132,87	134,23	
100	135,58	136,94	138,29	139,65	141,00	142,36	143,72	145,07	146,43	147,78	

Conversion Nm in in.lb											1 Nm = 8,85077 in.lb
Nm	0	1	2	3	4	5	6	7	8	9	
0	0,00	8,85	17,70	26,55	35,40	44,25	53,10	61,96	70,81	79,66	
10	88,51	97,36	106,21	115,06	123,91	132,76	141,61	150,46	159,31	168,16	
20	177,02	185,87	194,72	203,57	212,42	221,27	230,12	238,97	247,82	256,67	
30	265,52	274,37	283,22	292,08	300,93	309,78	318,63	327,48	336,33	345,18	
40	354,03	362,88	371,73	380,58	389,43	398,28	407,14	415,99	424,84	433,69	
50	442,54	451,39	460,24	469,09	477,94	486,79	495,64	504,49	513,34	522,20	
60	531,05	539,90	548,75	557,60	566,45	575,30	584,15	593,00	601,85	610,70	
70	619,55	628,40	637,26	646,11	654,96	663,81	672,66	681,51	690,36	699,21	
80	708,06	716,91	725,76	734,61	743,46	752,32	761,17	770,02	778,87	787,72	
90	796,57	805,42	814,27	823,12	831,97	840,82	849,67	858,52	867,38	876,23	
100	885,08	893,93	902,78	911,63	920,48	929,33	938,18	947,03	955,88	964,73	

Conversion in.lb in Nm											1 in.lb = 0,11298 Nm
in.lb	0	1	2	3	4	5	6	7	8	9	
0	0,00	0,11	0,23	0,34	0,45	0,56	0,68	0,79	0,90	1,02	
10	1,13	1,24	1,36	1,47	1,58	1,69	1,81	1,92	2,03	2,15	
20	2,26	2,37	2,49	2,60	2,71	2,82	2,94	3,05	3,16	3,28	
30	3,39	3,50	3,62	3,73	3,84	3,95	4,07	4,18	4,29	4,41	
40	4,52	4,63	4,75	4,86	4,97	5,08	5,20	5,31	5,42	5,54	
50	5,65	5,76	5,87	5,99	6,10	6,21	6,33	6,44	6,55	6,67	
60	6,78	6,89	7,00	7,12	7,23	7,34	7,46	7,57	7,68	7,80	
70	7,91	8,02	8,13	8,25	8,36	8,47	8,59	8,70	8,81	8,93	
80	9,04	9,15	9,26	9,38	9,49	9,60	9,72	9,83	9,94	10,06	
90	10,17	10,28	10,39	10,51	10,62	10,73	10,85	10,96	11,07	11,19	
100	11,30	11,41	11,52	11,64	11,75	11,86	11,98	12,09	12,20	12,31	



Conversion Of Inches To Millimeters

Inches		0	1	2	3	4	5	6	7	8	9
			25.400	50.800	76.200	101.600	127.000	152.400	177.800	203.200	228.600
1/64	0.015625	0.397	25.797	51.197	76.597	101.997	127.397	152.797	178.197	203.597	228.997
1/32	0.03125	0.794	26.194	51.594	76.994	102.394	127.794	153.194	178.594	203.994	229.394
3/64	0.046875	1.191	26.591	51.991	77.391	102.791	128.191	153.591	178.991	204.391	229.791
1/16	0.0625	1.588	26.988	52.388	77.788	103.188	128.588	153.988	179.388	204.788	230.188
5/64	0.078125	1.984	27.384	52.784	78.184	103.584	128.984	154.384	179.784	205.184	230.584
3/32	0.09375	2.381	27.781	53.181	78.581	103.981	129.381	154.781	180.181	205.581	230.981
7/64	0.109375	2.778	28.178	53.578	78.978	104.378	129.778	155.178	180.578	205.978	231.378
1/8	0.125	3.175	28.575	53.975	79.375	104.775	130.175	155.575	180.975	206.375	231.775
9/64	0.140625	3.572	28.972	54.372	79.772	105.172	130.572	155.972	181.372	206.772	232.172
5/32	0.15625	3.969	29.369	54.769	80.169	105.569	130.969	156.369	181.769	207.169	232.569
11/64	0.171875	4.366	29.766	55.166	80.566	105.966	131.366	156.766	182.166	207.566	232.966
3/16	0.1875	4.762	30.162	55.562	80.962	106.362	131.762	157.162	182.562	207.962	233.362
13/64	0.203125	5.159	30.559	55.959	81.359	106.759	132.159	157.559	182.959	208.359	233.759
7/32	0.21875	5.556	30.956	56.356	81.756	107.156	132.556	157.956	183.356	208.756	234.156
15/64	0.234375	5.953	31.353	56.753	82.153	107.553	132.953	158.353	183.753	209.153	234.553
1/4	0.25	6.350	31.750	57.150	82.550	107.950	133.350	158.750	184.150	209.550	234.950
17/64	0.265625	6.747	32.147	57.547	82.947	108.347	133.747	159.147	184.547	209.947	235.347
9/32	0.28125	7.144	32.544	57.944	83.344	108.744	134.144	159.544	184.944	210.344	235.744
19/64	0.296875	7.541	32.941	58.341	83.741	109.141	134.541	159.941	185.341	210.741	236.141
5/16	0.3125	7.938	33.338	58.738	84.138	109.538	134.938	160.338	185.738	211.138	236.538
21/64	0.328125	8.334	33.734	59.134	84.534	109.934	135.334	160.734	186.134	211.534	236.934
11/32	0.34375	8.731	34.131	59.531	84.931	110.331	135.731	161.131	186.531	211.931	237.331
23/64	0.359375	9.128	34.528	59.928	85.328	110.728	136.128	161.528	186.928	212.328	237.728
3/8	0.375	9.525	34.925	60.325	85.725	111.125	136.525	161.925	187.325	212.725	238.125
25/64	0.390625	9.922	35.322	60.722	86.122	111.522	136.922	162.322	187.722	213.122	238.522
13/32	0.40625	10.319	35.719	61.119	86.519	111.919	137.319	162.719	188.119	213.519	238.919
27/64	0.421875	10.716	36.116	61.516	86.916	112.316	137.716	163.116	188.516	213.916	239.316
7/16	0.4375	11.112	36.512	61.912	87.312	112.712	138.112	163.512	188.912	214.312	239.712
29/64	0.453125	11.509	36.909	62.309	87.709	113.109	138.509	163.909	189.309	214.709	240.109
15/32	0.46875	11.906	37.306	62.706	88.106	113.506	138.906	164.306	189.706	215.106	240.506
31/64	0.484375	12.303	37.703	63.103	88.503	113.903	139.303	164.703	190.103	215.503	240.903
1/2	0.5	12.700	38.100	63.500	88.900	114.300	139.700	165.100	190.500	215.900	241.300
33/64	0.515625	13.097	38.497	63.897	89.297	114.697	140.097	165.497	190.897	216.297	241.697
17/32	0.53125	13.494	38.894	64.294	89.694	115.094	140.494	165.894	191.294	216.694	242.094
35/64	0.546875	13.891	39.291	64.691	90.091	115.491	140.891	166.291	191.691	217.091	242.491
9/16	0.5625	14.288	39.688	65.088	90.488	115.888	141.288	166.688	192.088	217.488	242.888
37/64	0.578125	14.684	40.084	65.484	90.884	116.284	141.684	167.084	192.484	217.884	243.284
19/32	0.59375	15.081	40.481	65.881	91.281	116.681	142.081	167.481	192.881	218.281	243.681
39/64	0.609375	15.478	40.878	66.278	91.678	117.078	142.478	167.878	193.278	218.678	244.078
5/8	0.625	15.875	41.275	66.675	92.075	117.475	142.875	168.275	193.675	219.075	244.475
41/64	0.640625	16.272	41.672	67.072	92.472	117.872	143.272	168.672	194.072	219.472	244.872
21/32	0.65625	16.669	42.069	67.469	92.869	118.269	143.669	169.069	194.469	219.869	245.269
43/64	0.671875	17.066	42.466	67.866	93.266	118.666	144.066	169.466	194.866	220.266	245.666
11/16	0.6875	17.462	42.862	68.262	93.662	119.062	144.462	169.862	195.262	220.662	246.062
45/64	0.703125	17.859	43.259	68.659	94.059	119.459	144.859	170.259	195.659	221.059	246.459
23/32	0.71875	18.256	43.656	69.056	94.456	119.856	145.256	170.656	196.056	221.456	246.856
47/64	0.734375	18.653	44.053	69.453	94.853	120.253	145.653	171.053	196.453	221.853	247.253
3/4	0.75	19.050	44.450	69.850	95.250	120.650	146.050	171.450	196.850	222.250	247.650
49/64	0.765625	19.447	44.847	70.247	95.647	121.047	146.447	171.847	197.247	222.647	248.047
25/32	0.78125	19.844	45.244	70.644	96.044	121.444	146.844	172.244	197.644	223.044	248.444
51/64	0.796875	20.241	45.641	71.041	96.441	121.841	147.241	172.641	198.041	223.441	248.841
13/16	0.8125	20.638	46.038	71.438	96.838	122.238	147.638	173.038	198.438	223.838	249.238
53/64	0.828125	21.034	46.434	71.834	97.234	122.634	148.034	173.434	198.834	224.234	249.634
27/32	0.84375	21.431	46.831	72.231	97.631	123.031	148.431	173.831	199.231	224.631	250.031
55/64	0.859375	21.828	47.228	72.628	98.028	123.428	148.828	174.228	199.628	225.028	250.428
7/8	0.875	22.225	47.625	73.025	98.425	123.825	149.225	174.625	200.025	225.425	250.825
57/64	0.890625	22.622	48.022	73.422	98.822	124.222	149.622	175.022	200.422	225.822	251.222
29/32	0.90625	23.019	48.419	73.819	99.219	124.619	150.019	175.419	200.819	226.219	251.619
59/64	0.921875	23.416	48.816	74.216	99.616	125.016	150.416	175.816	201.216	226.616	252.016
15/16	0.9375	23.812	49.212	74.612	100.012	125.412	150.812	176.212	201.612	227.012	252.412
61/64	0.953125	24.209	49.609	75.009	100.409	125.809	151.209	176.609	202.009	227.409	252.809
31/32	0.96875	24.606	50.006	75.406	100.806	126.206	151.606	177.006	202.406	227.806	253.206
63/64	0.984375	25.003	50.403	75.803	101.203	126.603	152.003	177.403	202.803	228.203	253.603

Values in mm

Code No. Index

Code No.	Page	Code No.	Page	Code No.	Page	Code No.	Page
05 000005 001	383	05 002946 001	237	05 003093 001	126	05 003405 001	80
05 000010 001	383	05 002948 001	237	05 003094 001	126	05 003406 001	81
05 000015 001	383	05 002950 001	237	05 003180 001	128	05 003407 001	81
05 000020 001	383	05 002960 001	237	05 003181 001	128	05 003408 001	81
05 000025 001	383	05 002966 001	237	05 003185 001	126	05 003410 001	81
05 000030 001	383	05 002968 001	237	05 003210 001	236	05 003411 001	81
05 000035 001	383	05 002970 001	237	05 003320 001	109	05 003412 001	81
05 000105 001	384	05 002973 001	237	05 003321 001	109	05 003413 001	81
05 000110 001	384	05 002976 001	237	05 003322 001	109	05 003414 001	81
05 000115 001	384	05 002980 001	237	05 003330 001	108	05 003415 001	83
05 000120 001	384	05 002990 001	235	05 003331 001	108	05 003416 001	83
05 000125 001	384	05 003010 001	102	05 003332 001	108	05 003417 001	83
05 000130 001	384	05 003030 001	126	05 003333 001	108	05 003418 001	83
05 000135 001	384	05 003031 001	126	05 003334 001	108	05 003420 001	84
05 000205 001	384	05 003032 001	126	05 003335 001	108	05 003421 001	84
05 000210 001	384	05 003033 001	126	05 003336 001	108	05 003422 001	84
05 000215 001	384	05 003034 001	126	05 003337 001	108	05 003423 001	84
05 000220 001	384	05 003035 001	126	05 003338 001	108	05 003424 001	84
05 000225 001	384	05 003036 001	126	05 003339 001	108	05 003429 001	83
05 000230 001	384	05 003037 001	126	05 003340 001	108	05 003430 001	83
05 000235 001	384	05 003038 001	126	05 003341 001	108	05 003431 001	83
05 000305 001	384	05 003039 001	126	05 003342 001	108	05 003432 001	83
05 000310 001	384	05 003040 001	126	05 003345 001	109	05 003433 001	83
05 000315 001	384	05 003041 001	126	05 003350 001	109	05 003434 001	83
05 000320 001	384	05 003042 001	126	05 003351 001	109	05 003435 001	83
05 000325 001	384	05 003043 001	126	05 003352 001	109	05 003436 001	83
05 000330 001	384	05 003044 001	126	05 003353 001	109	05 003437 001	83
05 000335 001	384	05 003050 001	127	05 003354 001	109	05 003438 001	83
05 000405 001	384	05 003051 001	127	05 003355 001	109	05 003439 001	83
05 000410 001	384	05 003052 001	127	05 003360 001	106	05 003440 001	82
05 000415 001	384	05 003054 001	127	05 003361 001	106	05 003441 001	82
05 000420 001	384	05 003056 001	127	05 003362 001	106	05 003442 001	82
05 000425 001	384	05 003059 001	124	05 003363 001	106	05 003443 001	82
05 000430 001	384	05 003060 001	124	05 003364 001	106	05 003445 001	82
05 000435 001	384	05 003061 001	124	05 003365 001	106	05 003446 001	82
05 000505 001	384	05 003062 001	124	05 003366 001	106	05 003447 001	82
05 000510 001	384	05 003063 001	124	05 003367 001	106	05 003448 001	82
05 000515 001	384	05 003064 001	124	05 003368 001	106	05 003450 001	81
05 000520 001	384	05 003065 001	124	05 003369 001	106	05 003451 001	81
05 000525 001	384	05 003066 001	124	05 003370 001	106	05 003452 001	81
05 000530 001	384	05 003067 001	124	05 003371 001	106	05 003455 001	82
05 000535 001	384	05 003068 001	124	05 003372 001	106	05 003456 001	82
05 000605 001	384	05 003069 001	124	05 003375 001	107	05 003460 001	84
05 000610 001	384	05 003070 001	124	05 003380 001	108	05 003461 001	84
05 000615 001	384	05 003071 001	124	05 003381 001	108	05 003462 001	84
05 000620 001	384	05 003072 001	124	05 003382 001	108	05 003463 001	84
05 000625 001	384	05 003073 001	124	05 003383 001	108	05 003470 001	78
05 000630 001	384	05 003074 001	125	05 003384 001	108	05 003471 001	75
05 000635 001	384	05 003075 001	125	05 003385 001	108	05 003472 001	79
05 002900 001	236	05 003080 001	126	05 003386 001	108	05 003473 001	78
05 002901 001	233	05 003081 001	126	05 003387 001	108	05 003474 001	78
05 002910 001	237	05 003082 001	126	05 003388 001	108	05 003475 001	78
05 002913 001	237	05 003083 001	126	05 003389 001	108	05 003484 001	77
05 002920 001	237	05 003084 001	126	05 003390 001	106	05 003499 001	102
05 002923 001	237	05 003085 001	126	05 003391 001	106	05 003500 001	98
05 002926 001	237	05 003086 001	126	05 003392 001	106	05 003501 001	102
05 002930 001	237	05 003087 001	126	05 003393 001	106	05 003502 001	102
05 002933 001	237	05 003088 001	126	05 003400 001	80	05 003503 001	102
05 002936 001	237	05 003089 001	126	05 003401 001	80	05 003504 001	102
05 002938 001	237	05 003090 001	126	05 003402 001	80	05 003505 001	102
05 002940 001	237	05 003091 001	126	05 003403 001	80	05 003506 001	102
05 002943 001	237	05 003092 001	126	05 003404 001	80	05 003507 001	102



Code No. Index

Code No.	Page	Code No.	Page	Code No.	Page	Code No.	Page
05 003508 001	102	05 003585 001	130	05 003690 001	165	05 003832 001	146
05 003509 001	102	05 003590 001	131	05 003692 001	155	05 003833 001	146
05 003510 001	102	05 003591 001	130	05 003695 001	155	05 003834 001	146
05 003511 001	102	05 003592 001	130	05 003696 001	155	05 003835 001	146
05 003512 001	102	05 003594 001	114	05 003697 001	155	05 003836 001	146
05 003513 001	102	05 003596 001	114	05 003717 001	102	05 003837 001	146
05 003514 001	102	05 003600 001	134	05 003718 001	102	05 003838 001	146
05 003515 001	102	05 003601 001	141	05 003719 001	102	05 003840 001	148
05 003516 001	102	05 003602 001	141	05 003720 001	102	05 003841 001	148
05 003517 001	102	05 003603 001	141	05 003721 001	102	05 003842 001	148
05 003518 001	102	05 003604 001	141	05 003722 001	102	05 003843 001	148
05 003519 001	102	05 003605 001	141	05 003723 001	102	05 003844 001	148
05 003520 001	102	05 003606 001	141	05 003724 001	102	05 003845 001	148
05 003521 001	102	05 003607 001	141	05 003725 001	102	05 003850 001	146
05 003522 001	102	05 003608 001	141	05 003726 001	102	05 003851 001	146
05 003523 001	102	05 003609 001	141	05 003727 001	102	05 003852 001	146
05 003524 001	110	05 003610 001	141	05 003728 001	102	05 003853 001	146
05 003525 001	110	05 003611 001	141	05 003729 001	102	05 003854 001	146
05 003526 001	110	05 003612 001	141	05 003730 001	141	05 003855 001	146
05 003527 001	111	05 003613 001	141	05 003731 001	141	05 003856 001	146
05 003528 001	110	05 003614 001	141	05 003732 001	141	05 003857 001	146
05 003529 001	111	05 003615 001	141	05 003733 001	141	05 003858 001	146
05 003530 001	110	05 003616 001	141	05 003734 001	141	05 003880 001	103
05 003531 001	109	05 003617 001	141	05 003735 001	141	05 003881 001	108
05 003533 001	96	05 003618 001	141	05 003736 001	141	05 003882 001	107
05 003535 001	97	05 003619 001	141	05 003737 001	141	05 003883 001	103
05 003536 001	112	05 003620 001	141	05 003738 001	141	05 003884 001	104
05 003550 001	115	05 003621 001	141	05 003739 001	141	05 003890 001	111
05 003551 001	120	05 003622 001	141	05 003740 001	120	05 003891 001	111
05 003552 001	120	05 003623 001	141	05 003741 001	120	05 003892 001	155
05 003553 001	120	05 003624 001	141	05 003742 001	120	05 003893 001	156
05 003554 001	120	05 003625 001	141	05 003743 001	120	05 003970 001	121
05 003555 001	120	05 003626 001	141	05 003744 001	120	05 003971 001	127
05 003556 001	120	05 003627 001	141	05 003745 001	120	05 003972 001	125
05 003557 001	120	05 003628 001	141	05 003746 001	120	05 003973 001	121
05 003558 001	120	05 003629 001	141	05 003747 001	120	05 003974 001	129
05 003559 001	120	05 003630 001	141	05 003748 001	120	05 003980 001	131
05 003560 001	120	05 003631 001	141	05 003749 001	120	05 003981 001	131
05 003561 001	120	05 003632 001	141	05 003750 001	120	05 003982 001	89
05 003562 001	120	05 003633 001	141	05 003751 001	120	05 003990 001	79
05 003563 001	120	05 003634 001	141	05 003752 001	120	05 003991 001	71
05 003564 001	120	05 003635 001	141	05 003753 001	120	05 003995 001	142
05 003565 001	120	05 003636 001	151	05 003755 001	94	05 003996 001	149
05 003566 001	120	05 003637 001	150	05 003756 001	101	05 003997 001	146
05 003567 001	120	05 003638 001	150	05 003760 001	171	05 004003 001	100
05 003568 001	120	05 003639 001	151	05 003765 001	171	05 004004 001	101
05 003569 001	120	05 003640 001	151	05 003780 001	135	05 004016 001	95
05 003570 001	120	05 003641 001	151	05 003781 001	136	05 004016 001	256
05 003571 001	120	05 003642 001	150	05 003785 001	119	05 004017 001	99
05 003572 001	120	05 003643 001	150	05 003793 001	165	05 004018 001	100
05 003573 001	120	05 003645 001	133	05 003820 001	148	05 004019 001	95
05 003574 001	120	05 003647 001	134	05 003821 001	148	05 004020 001	99
05 003575 001	120	05 003660 001	164	05 003822 001	148	05 004021 001	101
05 003576 001	120	05 003665 001	165	05 003823 001	148	05 004033 001	117
05 003577 001	120	05 003666 001	165	05 003824 001	148	05 004034 001	119
05 003578 001	120	05 003667 001	165	05 003825 001	148	05 004046 001	113
05 003579 001	120	05 003668 001	165	05 003826 001	148	05 004047 001	116
05 003580 001	120	05 003669 001	165	05 003827 001	148	05 004048 001	118
05 003581 001	130	05 003670 001	165	05 003828 001	148	05 004049 001	113
05 003582 001	130	05 003675 001	165	05 003829 001	148	05 004050 001	117
05 003583 001	130	05 003684 001	165	05 003830 001	146	05 004051 001	119
05 003584 001	131	05 003685 001	165	05 003831 001	146	05 004063 001	137



Code No.	Page	Code No.	Page	Code No.	Page	Code No.	Page
05 004064 001	138	05 004431 001	83	05 004578 001	138	05 005300 001	64
05 004076 001	132	05 004432 001	83	05 004580 001	139	05 005305 001	64
05 004077 001	136	05 004433 001	83	05 004590 001	143	05 005310 001	64
05 004078 001	137	05 004434 001	83	05 004591 001	143	05 005315 001	64
05 004079 001	133	05 004436 001	83	05 004592 001	143	05 005320 001	64
05 004080 001	137	05 004447 001	83	05 004595 001	144	05 005325 001	64
05 004081 001	138	05 004448 001	83	05 004780 001	64	05 005330 001	64
05 004090 001	135	05 004455 001	82	05 004781 001	64	05 005335 001	64
05 004095 001	135	05 004456 001	82	05 004782 001	64	05 005340 001	64
05 004170 001	162	05 004500 001	105	05 004783 001	64	05 005400 001	104
05 004171 001	212	05 004501 001	105	05 004784 001	64	05 005410 001	106
05 004172 001	163	05 004502 001	105	05 004830 001	140	05 005420 001	104
05 004173 001	188	05 004503 001	105	05 004831 001	140	05 005430 001	122
05 004174 001	48	05 004504 001	105	05 004832 001	140	05 005440 001	124
05 004175 001	115	05 004505 001	105	05 004833 001	140	05 005450 001	122
05 004176 001	129	05 004506 001	105	05 004834 001	140	05 005460 001	147
05 004177 001	163	05 004507 001	105	05 004835 001	140	05 005470 001	145
05 004178 001	175	05 004508 001	105	05 004836 001	140	05 005480 001	142
05 004179 001	223	05 004509 001	105	05 004837 001	140	05 005490 001	139
05 004180 001	366	05 004510 001	105	05 004838 001	140	05 005655 001	64
05 004181 001	176	05 004511 001	105	05 004839 001	140	05 006100 001	60
05 004182 001	33	05 004512 001	105	05 004840 001	140	05 006105 001	60
05 004184 001	33	05 004525 001	105	05 004841 001	140	05 006110 001	60
05 004185 001	223	05 004530 001	123	05 004900 001	88	05 006115 001	60
05 004190 001	30	05 004531 001	123	05 004901 001	88	05 006116 001	60
05 004201 001	149	05 004532 001	123	05 004902 001	88	05 006120 001	60
05 004202 001	147	05 004533 001	123	05 004903 001	88	05 006121 001	60
05 004203 001	143	05 004534 001	123	05 004920 001	88	05 006125 001	60
05 004210 001	149	05 004535 001	123	05 004921 001	88	05 006126 001	60
05 004211 001	147	05 004536 001	123	05 004922 001	88	05 006130 001	60
05 004212 001	148	05 004537 001	123	05 004923 001	88	05 006135 001	60
05 004280 001	152	05 004538 001	123	05 004924 001	88	05 006140 001	60
05 004281 001	153	05 004539 001	123	05 004925 001	88	05 006145 001	65
05 004282 001	152	05 004540 001	123	05 004930 001	87	05 006147 001	66
05 004283 001	154	05 004541 001	123	05 004940 001	88	05 006148 001	66
05 004310 001	65	05 004542 001	123	05 004941 001	88	05 006150 001	61
05 004313 001	22	05 004543 001	123	05 004942 001	88	05 006152 001	61
05 004350 001	252	05 004544 001	123	05 004950 001	88	05 006153 001	61
05 004351 001	252	05 004545 001	123	05 004951 001	88	05 006154 001	61
05 004351 001	256	05 004550 001	144	05 004952 001	88	05 006156 001	61
05 004352 001	253	05 004551 001	144	05 004953 001	88	05 006158 001	61
05 004353 001	254	05 004552 001	144	05 004954 001	88	05 006159 001	61
05 004354 001	254	05 004553 001	144	05 004955 001	88	05 006160 001	62
05 004355 001	254	05 004554 001	144	05 004956 001	88	05 006162 001	62
05 004356 001	254	05 004555 001	144	05 004957 001	88	05 006163 001	62
05 004357 001	253	05 004556 001	144	05 004958 001	88	05 006164 001	62
05 004400 001	80	05 004557 001	144	05 004959 001	88	05 006165 001	62
05 004401 001	80	05 004558 001	144	05 004960 001	88	05 006166 001	62
05 004402 001	80	05 004559 001	144	05 004961 001	88	05 006168 001	62
05 004403 001	80	05 004560 001	144	05 004962 001	88	05 006169 001	64
05 004404 001	80	05 004561 001	144	05 004963 001	88	05 006170 001	64
05 004405 001	80	05 004562 001	144	05 004964 001	89	05 006172 001	64
05 004406 001	81	05 004563 001	144	05 004965 001	89	05 006174 001	64
05 004407 001	81	05 004565 001	145	05 004966 001	87	05 006176 001	64
05 004408 001	81	05 004570 001	138	05 004970 001	86	05 006177 001	64
05 004413 001	81	05 004571 001	138	05 004980 001	91	05 006178 001	64
05 004414 001	81	05 004572 001	138	05 004981 001	91	05 006179 001	64
05 004420 001	84	05 004573 001	138	05 005080 001	364	05 006181 001	64
05 004421 001	84	05 004574 001	138	05 005081 001	364	05 006182 001	64
05 004422 001	84	05 004575 001	138	05 005090 001	364	05 006183 001	64
05 004423 001	84	05 004576 001	138	05 005091 001	364	05 006184 001	64
05 004424 001	84	05 004577 001	138	05 005120 001	86	05 006190 001	63



Code No. Index

Code No.	Page	Code No.	Page	Code No.	Page	Code No.	Page
05 006191 001	63	05 008844 001	20	05 018142 001	220	05 020093 001	172
05 006380 001	62	05 008850 001	20	05 018150 001	219	05 020099 001	178
05 006381 001	62	05 008851 001	20	05 018151 001	219	05 020100 001	178
05 006440 001	61	05 008852 001	20	05 018152 001	219	05 020101 001	178
05 006441 001	61	05 008853 001	20	05 018153 001	219	05 020102 001	179
05 006442 001	61	05 008854 001	20	05 018154 001	219	05 020103 001	178
05 006450 001	61	05 008855 001	20	05 018155 001	219	05 020104 001	178
05 006451 001	61	05 008856 001	20	05 018156 001	219	05 020110 001	179
05 006455 001	63	05 008857 001	20	05 018157 001	219	05 020129 001	61
05 006456 001	63	05 008858 001	20	05 018160 001	218	05 020131 001	62
05 006460 001	62	05 008859 001	20	05 018161 001	218	05 020132 001	63
05 006461 001	62	05 008860 001	20	05 018162 001	218	05 020133 001	62
05 006465 001	63	05 008861 001	20	05 018163 001	219	05 020134 001	63
05 006466 001	63	05 008862 001	20	05 018164 001	219	05 020150 001	90
05 006470 001	69	05 008863 001	21	05 018165 001	219	05 020151 001	91
05 006480 001	66	05 008864 001	21	05 018166 001	219	05 020152 001	91
05 007610 001	13	05 008870 001	28	05 018167 001	219	05 020153 001	91
05 007620 001	13	05 008871 001	29	05 018168 001	219	05 020170 001	90
05 007621 001	13	05 008872 001	29	05 018169 001	219	05 020190 001	173
05 007635 001	13	05 008873 001	221	05 018170 001	219	05 020198 001	173
05 007640 001	13	05 008874 001	221	05 018171 001	220	05 020199 001	173
05 007670 001	13	05 008875 001	222	05 018172 001	220	05 020200 001	173
05 007671 001	13	05 008876 001	29	05 018173 001	220	05 020201 001	173
05 007672 001	13	05 008877 001	222	05 018260 001	8	05 020202 001	173
05 007673 001	13	05 008878 001	222	05 018262 001	8	05 020203 001	173
05 007674 001	13	05 008880 001	232	05 018264 001	8	05 020204 001	173
05 007675 001	13	05 008881 001	57	05 018266 001	8	05 020205 001	173
05 007676 001	13	05 008882 001	57	05 018268 001	8	05 020206 001	173
05 007677 001	13	05 008883 001	220	05 018270 001	8	05 020207 001	173
05 007680 001	22	05 008884 001	221	05 018272 001	8	05 020208 001	173
05 007681 001	23	05 008885 001	221	05 018274 001	8	05 020209 001	173
05 008006 001	12	05 008886 001	221	05 018282 001	11	05 020210 001	173
05 008007 001	12	05 008900 001	29	05 018283 001	11	05 020211 001	173
05 008008 001	12	05 008901 001	30	05 018287 001	11	05 020212 001	173
05 008009 001	12	05 009305 001	14	05 018300 001	8	05 020213 001	173
05 008015 001	12	05 009310 001	14	05 018301 001	8	05 020214 001	173
05 008027 001	12	05 009312 001	14	05 018302 001	8	05 020215 001	173
05 008055 001	12	05 009313 001	14	05 020012 001	169	05 020216 001	173
05 008060 001	12	05 009315 001	14	05 020013 001	169	05 020217 001	173
05 008061 001	12	05 009317 001	14	05 020022 001	169	05 020218 001	173
05 008100 001	27	05 009319 001	14	05 020064 001	170	05 020219 001	173
05 008101 001	18	05 009320 001	14	05 020065 001	170	05 020220 001	173
05 008102 001	18	05 009325 001	14	05 020066 001	170	05 020221 001	173
05 008705 001	13	05 009340 001	14	05 020067 001	170	05 020228 001	177
05 008706 001	13	05 009341 001	14	05 020068 001	170	05 020229 001	177
05 008710 001	13	05 009342 001	14	05 020069 001	170	05 020230 001	175
05 008712 001	13	05 009343 001	14	05 020070 001	170	05 020231 001	174
05 008715 001	13	05 017005 001	9	05 020071 001	170	05 020232 001	174
05 008720 001	13	05 017010 001	9	05 020072 001	170	05 020240 001	176
05 008723 001	13	05 017015 001	9	05 020073 001	170	05 020241 001	175
05 008725 001	13	05 017020 001	9	05 020074 001	170	05 020259 001	171
05 008730 001	13	05 017040 001	9	05 020075 001	171	05 020260 001	171
05 008735 001	13	05 017041 001	9	05 020076 001	171	05 020261 001	171
05 008740 001	13	05 017050 001	9	05 020077 001	171	05 020262 001	171
05 008750 001	13	05 017052 001	9	05 020078 001	171	05 020263 001	171
05 008751 001	13	05 017054 001	9	05 020079 001	171	05 020264 001	171
05 008752 001	13	05 017056 001	9	05 020080 001	171	05 020302 001	174
05 008753 001	13	05 018100 001	218	05 020081 001	171	05 020310 001	179
05 008840 001	20	05 018110 001	217	05 020082 001	171	05 020311 001	179
05 008841 001	20	05 018111 001	218	05 020090 001	172	05 020312 001	179
05 008842 001	20	05 018140 001	220	05 020091 001	171	05 020313 001	179
05 008843 001	20	05 018141 001	220	05 020092 001	172	05 020314 001	179

Code No.	Page	Code No.	Page	Code No.	Page	Code No.	Page
05 020500 001	173	05 022067 001	192	05 022665 001	189	05 022760 001	59
05 020501 001	173	05 022068 001	192	05 022666 001	189	05 022761 001	59
05 020502 001	173	05 022070 001	192	05 022667 001	189	05 022762 001	59
05 020503 001	173	05 022071 001	192	05 022668 001	189	05 022763 001	59
05 020504 001	173	05 022072 001	192	05 022669 001	182	05 022764 001	59
05 020505 001	173	05 022073 001	192	05 022670 001	191	05 022765 001	59
05 020506 001	173	05 022074 001	192	05 022671 001	191	05 022766 001	59
05 020507 001	173	05 022076 001	192	05 022672 001	191	05 022767 001	60
05 021005 001	193	05 022078 001	192	05 022673 001	191	05 022795 001	15
05 021010 001	193	05 022079 001	192	05 022674 001	191	05 022800 001	15
05 021015 001	193	05 022080 001	192	05 022675 001	191	05 022805 001	15
05 021020 001	193	05 022081 001	192	05 022676 001	191	05 022810 001	15
05 021025 001	193	05 022082 001	192	05 022677 001	191	05 022815 001	15
05 021030 001	193	05 022086 001	186	05 022678 001	191	05 022820 001	15
05 021035 001	193	05 022087 001	185	05 022680 001	197	05 022825 001	15
05 021040 001	193	05 022089 001	184	05 022681 001	197	05 022830 001	15
05 021045 001	193	05 022095 001	192	05 022682 001	197	05 022835 001	15
05 021050 001	193	05 022096 001	192	05 022683 001	197	05 022850 001	190
05 021055 001	193	05 022101 001	187	05 022684 001	197	05 022851 001	190
05 021060 001	193	05 022120 001	193	05 022685 001	197	05 022852 001	190
05 021065 001	193	05 022121 001	193	05 022686 001	197	05 022853 001	190
05 021070 001	193	05 022122 001	193	05 022687 001	197	05 022854 001	190
05 021075 001	193	05 022123 001	193	05 022688 001	197	05 022855 001	190
05 021080 001	193	05 022124 001	193	05 022689 001	195	05 022856 001	190
05 021085 001	193	05 022125 001	193	05 022693 001	189	05 022857 001	190
05 021090 001	193	05 022130 001	185	05 022694 001	189	05 022858 001	190
05 021095 001	193	05 022171 001	188	05 022695 001	189	05 022860 001	184
05 021406 001	186	05 022181 001	187	05 022696 001	189	05 022905 001	15
05 021600 001	193	05 022200 001	190	05 022697 001	189	05 022910 001	15
05 021605 001	193	05 022201 001	190	05 022698 001	189	05 022920 001	15
05 021610 001	193	05 022202 001	190	05 022699 001	182	05 023105 001	15
05 021615 001	193	05 022203 001	190	05 022700 001	190	05 023107 001	15
05 021620 001	193	05 022204 001	190	05 022701 001	190	05 023110 001	15
05 021625 001	193	05 022205 001	190	05 022702 001	190	05 023115 001	15
05 021630 001	193	05 022210 001	183	05 022703 001	190	05 023120 001	15
05 021632 001	193	05 022210 001	256	05 022704 001	190	05 023125 001	15
05 021635 001	193	05 022534 001	185	05 022705 001	190	05 023130 001	15
05 021640 001	193	05 022600 001	191	05 022706 001	190	05 023330 001	41
05 021645 001	193	05 022602 001	191	05 022708 001	190	05 023332 001	41
05 021721 001	188	05 022604 001	191	05 022709 001	190	05 023334 001	42
05 021728 001	187	05 022606 001	191	05 022710 001	190	05 023338 001	42
05 021737 001	187	05 022608 001	191	05 022711 001	190	05 023339 001	42
05 021909 001	186	05 022610 001	191	05 022712 001	190	05 023340 001	42
05 022040 001	192	05 022612 001	191	05 022713 001	190	05 023342 001	42
05 022041 001	192	05 022614 001	191	05 022714 001	190	05 023343 001	42
05 022042 001	192	05 022616 001	191	05 022715 001	190	05 023344 001	42
05 022043 001	192	05 022630 001	191	05 022716 001	190	05 023346 001	42
05 022044 001	192	05 022631 001	191	05 022717 001	190	05 023347 001	42
05 022045 001	192	05 022632 001	191	05 022718 001	190	05 023348 001	42
05 022046 001	192	05 022633 001	191	05 022720 001	183	05 023350 001	42
05 022047 001	192	05 022634 001	191	05 022721 001	183	05 023351 001	42
05 022048 001	192	05 022635 001	191	05 022728 001	59	05 023352 001	42
05 022050 001	192	05 022636 001	191	05 022729 001	59	05 023353 001	42
05 022052 001	192	05 022637 001	191	05 022730 001	59	05 023354 001	42
05 022054 001	192	05 022638 001	191	05 022731 001	59	05 023355 001	42
05 022056 001	192	05 022639 001	185	05 022732 001	59	05 023356 001	42
05 022058 001	192	05 022640 001	185	05 022733 001	59	05 023357 001	42
05 022060 001	192	05 022660 001	189	05 022734 001	59	05 023358 001	42
05 022062 001	192	05 022661 001	189	05 022740 001	59	05 023359 001	42
05 022063 001	192	05 022662 001	189	05 022741 001	59	05 023360 001	42
05 022064 001	192	05 022663 001	189	05 022745 001	59	05 023361 001	42
05 022066 001	192	05 022664 001	189	05 022750 001	60	05 023362 001	42



Code No. Index

Code No.	Page	Code No.	Page	Code No.	Page	Code No.	Page
05 023363 001	42	05 024171 001	197	05 024478 001	197	05 027935 001	363
05 023364 001	42	05 024172 001	197	05 024479 001	197	05 027936 001	363
05 023365 001	42	05 024173 001	197	05 024480 001	195	05 028000 001	16
05 023366 001	42	05 024174 001	197	05 024481 001	198	05 028001 001	16
05 023367 001	42	05 024175 001	197	05 024482 001	198	05 028002 001	16
05 023368 001	42	05 024176 001	197	05 024483 001	198	05 028003 001	16
05 023369 001	42	05 024177 001	197	05 024484 001	197	05 028004 001	16
05 023370 001	42	05 024178 001	197	05 024485 001	197	05 028005 001	16
05 023371 001	42	05 024179 001	195	05 024486 001	197	05 028008 001	16
05 023372 001	42	05 024199 001	199	05 024487 001	197	05 028010 001	16
05 023373 001	42	05 024200 001	199	05 024488 001	197	05 028012 001	16
05 023374 001	42	05 024202 001	199	05 024489 001	197	05 028013 001	16
05 023375 001	42	05 024204 001	199	05 026350 001	30	05 028015 001	16
05 023376 001	42	05 024206 001	199	05 026351 001	30	05 028020 001	16
05 023377 001	42	05 024208 001	199	05 026352 001	30	05 028029 001	17
05 023378 001	42	05 024210 001	199	05 026353 001	30	05 028030 001	17
05 023379 001	42	05 024242 001	196	05 026354 001	30	05 028031 001	17
05 023380 001	42	05 024244 001	195	05 026360 001	31	05 028032 001	17
05 023381 001	43	05 024335 001	196	05 026361 001	31	05 028033 001	17
05 023382 001	43	05 024350 001	198	05 026363 001	31	05 028034 001	17
05 023383 001	43	05 024351 001	198	05 026372 001	31	05 028035 001	17
05 023384 001	43	05 024352 001	198	05 026373 001	31	05 028036 001	17
05 023385 001	43	05 024353 001	198	05 026374 001	31	05 028037 001	17
05 023386 001	43	05 024354 001	198	05 026382 001	31	05 028038 001	17
05 023387 001	43	05 024355 001	198	05 027101 001	192	05 028040 001	363
05 023389 001	43	05 024356 001	198	05 027102 001	192	05 028041 001	363
05 023391 001	43	05 024357 001	198	05 027103 001	192	05 028042 001	363
05 023393 001	43	05 024358 001	198	05 027104 001	192	05 028043 001	363
05 023400 001	236	05 024400 001	9	05 027105 001	192	05 028044 001	363
05 023404 001	43	05 024401 001	9	05 027106 001	192	05 028045 001	363
05 023450 001	45	05 024402 001	9	05 027107 001	192	05 028046 001	364
05 023451 001	46	05 024403 001	9	05 027108 001	192	05 028048 001	16
05 023452 001	47	05 024404 001	9	05 027109 001	192	05 028049 001	16
05 023453 001	45	05 024405 001	9	05 027110 001	192	05 028050 001	16
05 023454 001	46	05 024410 001	11	05 027111 001	192	05 028051 001	16
05 023456 001	47	05 024450 001	195	05 027201 001	194	05 028052 001	16
05 023460 001	44	05 024451 001	198	05 027202 001	194	05 028053 001	16
05 023461 001	44	05 024452 001	198	05 027203 001	194	05 028054 001	16
05 023470 001	216	05 024453 001	198	05 027204 001	194	05 028055 001	16
05 023471 001	215	05 024454 001	198	05 027205 001	194	05 028056 001	16
05 024001 001	199	05 024455 001	198	05 027206 001	194	05 028059 001	26
05 024002 001	199	05 024456 001	198	05 027207 001	194	05 028062 001	27
05 024003 001	199	05 024457 001	198	05 027208 001	194	05 028070 001	16
05 024004 001	199	05 024458 001	198	05 027209 001	194	05 028071 001	16
05 024005 001	199	05 024459 001	198	05 027210 001	194	05 028072 001	16
05 024008 001	199	05 024460 001	196	05 027211 001	194	05 028073 001	16
05 024010 001	199	05 024461 001	199	05 027212 001	194	05 028074 001	26
05 024012 001	199	05 024462 001	199	05 027213 001	194	05 028148 001	18
05 024013 001	199	05 024463 001	199	05 027214 001	194	05 028150 001	18
05 024015 001	199	05 024464 001	198	05 027215 001	194	05 028152 001	18
05 024020 001	199	05 024465 001	198	05 027405 001	31	05 028160 001	231
05 024100 001	199	05 024466 001	198	05 027450 001	51	05 028161 001	231
05 024105 001	199	05 024467 001	198	05 027455 001	31	05 028205 001	19
05 024160 001	199	05 024468 001	198	05 027456 001	37	05 028210 001	19
05 024161 001	199	05 024469 001	198	05 027910 001	363	05 028215 001	19
05 024162 001	199	05 024470 001	195	05 027911 001	363	05 028220 001	19
05 024163 001	199	05 024471 001	197	05 027912 001	363	05 028225 001	19
05 024164 001	199	05 024472 001	197	05 027913 001	363	05 028230 001	19
05 024165 001	199	05 024473 001	197	05 027930 001	363	05 029405 001	19
05 024166 001	199	05 024474 001	197	05 027931 001	363	05 029410 001	19
05 024167 001	199	05 024475 001	197	05 027932 001	363	05 029415 001	19
05 024168 001	199	05 024476 001	197	05 027933 001	363	05 029420 001	19
05 024170 001	197	05 024477 001	197	05 027934 001	363	05 029425 001	19



Code No.	Page	Code No.	Page	Code No.	Page	Code No.	Page
05 029430 001	19	05 030402 001	50	05 042605 001	319	05 051603 001	85
05 029435 001	19	05 030403 001	50	05 042655 001	319	05 051611 001	85
05 029440 001	19	05 030404 001	50	05 042665 001	319	05 051613 001	85
05 029445 001	19	05 030405 001	50	05 042670 001	318	05 051835 001	236
05 029450 001	19	05 030406 001	50	05 042671 001	318	05 052490 001	312
05 029460 001	19	05 030410 001	51	05 042672 001	318	05 052500 001	312
05 029461 001	19	05 030411 001	51	05 042673 001	318	05 052501 001	313
05 029462 001	19	05 030412 001	51	05 042674 001	318	05 052502 001	312
05 029463 001	19	05 030413 001	51	05 042680 001	318	05 052503 001	312
05 029464 001	19	05 030414 001	51	05 042705 001	319	05 052504 001	312
05 029465 001	19	05 030415 001	51	05 042715 001	319	05 052575 001	314
05 029466 001	19	05 030416 001	51	05 042750 001	319	05 053425 001	315
05 029501 001	19	05 030417 001	51	05 042755 001	319	05 053455 001	315
05 029502 001	19	05 030418 001	51	05 042760 001	319	05 053457 001	315
05 029503 001	19	05 032001 001	6	05 042765 001	319	05 053458 001	315
05 029504 001	19	05 032002 001	6	05 042768 001	319	05 053459 001	315
05 029505 001	19	05 032003 001	6	05 050005 001	103	05 053475 001	315
05 029506 001	19	05 032004 001	6	05 050205 001	317	05 053520 001	313
05 029507 001	19	05 032005 001	6	05 050210 001	317	05 053522 001	313
05 029510 001	28	05 032006 001	6	05 050215 001	317	05 053870 001	313
05 030080 001	51	05 032007 001	6	05 050220 001	317	05 053872 001	313
05 030081 001	51	05 032020 001	6	05 050510 001	317	05 053923 001	311
05 030082 001	51	05 032021 001	6	05 050650 001	317	05 056064 001	291
05 030083 001	51	05 032022 001	6	05 051005 001	232	05 056066 001	291
05 030084 001	51	05 032023 001	6	05 051010 001	21	05 056068 001	291
05 030099 001	49	05 032030 001	7	05 051011 001	22	05 056158 001	336
05 030100 001	49	05 032031 001	7	05 051016 001	204	05 056159 001	333
05 030101 001	49	05 032032 001	7	05 051017 001	205	05 056161 001	332
05 030102 001	49	05 032033 001	7	05 051019 001	205	05 056164 001	334
05 030103 001	49	05 032050 001	7	05 051021 001	205	05 056168 001	336
05 030104 001	49	05 032051 001	7	05 051023 001	205	05 056172 001	290
05 030105 001	49	05 032052 001	7	05 051024 001	206	05 056174 001	290
05 030106 001	49	05 032053 001	7	05 051025 001	206	05 056176 001	290
05 030107 001	49	05 032054 001	7	05 051030 001	234	05 056200 001	291
05 030108 001	49	05 032055 001	7	05 051031 001	234	05 056203 001	291
05 030109 001	50	05 032056 001	7	05 051040 001	233	05 056210 001	291
05 030110 001	49	05 032057 001	7	05 051041 001	233	05 056220 001	291
05 030111 001	49	05 032058 001	7	05 051042 001	211	05 056225 001	291
05 030112 001	49	05 032060 001	7	05 051043 001	55	05 056233 001	291
05 030113 001	50	05 032061 001	7	05 051045 001	98	05 056240 001	291
05 030114 001	50	05 032063 001	8	05 051205 001	232	05 056294 001	335
05 030115 001	50	05 032070 002	7	05 051272 001	231	05 056295 001	334
05 030116 001	50	05 032071 002	7	05 051273 001	54	05 056296 001	335
05 030117 001	49	05 033404 001	31	05 051274 001	232	05 056303 001	294
05 030118 001	49	05 033600 001	72	05 051276 001	37	05 056305 001	294
05 030119 001	49	05 033601 001	72	05 051461 001	233	05 056310 001	294
05 030120 001	50	05 033606 001	72	05 051462 001	231	05 056315 001	294
05 030121 001	50	05 033607 001	72	05 051464 001	54	05 056320 001	294
05 030122 001	50	05 033608 001	72	05 051465 001	230	05 056325 001	294
05 030135 001	50	05 033613 001	72	05 051482 001	230	05 056330 001	294
05 030150 001	51	05 033614 001	72	05 051500 001	314	05 056332 001	294
05 030151 001	51	05 033629 001	73	05 051501 001	314	05 056335 001	294
05 030158 001	50	05 033630 001	73	05 051502 001	314	05 056340 001	294
05 030159 001	50	05 033631 001	73	05 051510 001	206	05 056341 001	298
05 030160 001	35	05 033636 001	73	05 051511 001	207	05 056342 001	298
05 030170 001	53	05 033637 001	73	05 051512 001	207	05 056343 001	298
05 030180 001	53	05 033638 001	73	05 051575 001	85	05 056344 001	298
05 030181 001	40	05 033639 001	73	05 051576 001	86	05 056345 001	298
05 030182 001	53	05 033647 001	73	05 051580 001	85	05 056346 001	298
05 030330 001	51	05 033648 001	73	05 051582 001	85	05 056350 001	295
05 030331 001	51	05 033655 001	73	05 051583 001	85	05 056352 001	295
05 030400 001	50	05 033656 001	73	05 051587 001	85	05 056354 001	295
05 030401 001	50	05 040001 001	236	05 051601 001	85	05 056356 001	295

Code No. Index

Code No.	Page	Code No.	Page	Code No.	Page	Code No.	Page
05 056358 001	295	05 057122 001	331	05 057626 001	279	05 059298 001	208
05 056374 001	328	05 057150 001	305	05 057627 001	279	05 059299 001	208
05 056375 001	333	05 057151 001	305	05 057628 001	279	05 059303 001	210
05 056400 001	261	05 057152 001	305	05 057631 001	300	05 059305 001	292
05 056402 001	261	05 057153 001	305	05 057632 001	300	05 059307 001	292
05 056404 001	261	05 057160 001	305	05 057644 001	295	05 059310 001	292
05 056410 001	261	05 057161 001	305	05 057645 001	295	05 059315 001	292
05 056412 001	261	05 057162 001	305	05 057646 001	295	05 059320 001	292
05 056414 001	261	05 057163 001	305	05 057656 001	265	05 059325 001	292
05 056420 001	262	05 057225 001	292	05 057657 001	265	05 059330 001	292
05 056422 001	262	05 057235 001	292	05 057661 001	275	05 059335 001	292
05 056424 001	262	05 057240 001	292	05 057662 001	275	05 059337 001	292
05 056440 001	332	05 057412 001	330	05 057664 001	284	05 059340 001	292
05 056470 001	341	05 057415 001	330	05 057665 001	284	05 059345 001	292
05 056471 001	338	05 057416 001	329	05 057666 001	284	05 059450 001	292
05 056472 001	337	05 057417 001	323	05 057667 001	284	05 059451 001	292
05 056473 001	337	05 057418 001	161	05 057671 001	301	05 059452 001	292
05 056474 001	336	05 057420 001	327	05 057672 001	301	05 059453 001	292
05 056478 001	338	05 057421 001	329	05 057675 001	310	05 059466 001	292
05 056490 001	159	05 057422 001	340	05 057676 001	310	05 059472 001	292
05 056491 001	159	05 057423 001	340	05 057680 001	322	05 059478 001	292
05 056500 001	264	05 057424 001	342	05 057682 001	323	05 059480 001	292
05 056505 001	264	05 057430 001	327	05 057683 001	323	05 059486 001	292
05 056507 001	264	05 057431 001	329	05 057684 001	323	05 059488 001	292
05 056510 001	264	05 057432 001	339	05 057688 001	323	05 059489 001	292
05 056515 001	264	05 057433 001	339	05 057690 001	322	05 059490 001	292
05 056520 001	264	05 057434 001	341	05 057691 001	324	05 059492 001	292
05 056525 001	264	05 057435 001	339	05 057692 001	324	05 059496 001	292
05 056535 001	264	05 057436 001	338	05 057693 001	324	05 059500 001	292
05 056605 001	263	05 057441 001	326	05 057695 001	324	05 059530 001	266
05 056610 001	263	05 057450 001	331	05 057697 001	322	05 059532 001	266
05 056625 001	263	05 057460 001	214	05 057705 001	270	05 059534 001	266
05 056653 001	203	05 057470 001	215	05 057710 001	270	05 059540 001	267
05 056680 001	294	05 057471 001	222	05 057715 001	270	05 059542 001	267
05 056681 001	294	05 057472 001	57	05 057720 001	270	05 059544 001	267
05 056682 001	294	05 057473 001	216	05 057750 001	265	05 059550 001	267
05 056683 001	294	05 057474 001	217	05 057751 001	262	05 059552 001	267
05 056684 001	294	05 057480 001	203	05 057752 001	260	05 059554 001	267
05 056685 001	294	05 057481 001	80	05 057760 001	275	05 059560 001	292
05 056686 001	294	05 057482 001	202	05 057761 001	273	05 059561 001	296
05 056687 001	294	05 057483 001	202	05 057762 001	273	05 059562 001	296
05 056700 001	272	05 057484 001	79	05 057763 001	271	05 059563 001	296
05 056702 001	272	05 057484 001	256	05 057770 001	283	05 059564 001	269
05 056704 001	272	05 057485 001	80	05 057772 001	279	05 059565 001	269
05 056710 001	273	05 057505 001	298	05 057773 001	283	05 059566 001	277
05 056712 001	273	05 057510 001	298	05 057775 001	279	05 059567 001	277
05 056714 001	273	05 057515 001	298	05 057776 001	279	05 059568 001	288
05 056720 001	273	05 057520 001	298	05 057777 001	282	05 059569 001	288
05 056722 001	273	05 057525 001	298	05 057778 001	282	05 059570 001	288
05 056724 001	273	05 057530 001	298	05 057790 001	300	05 059571 001	288
05 056805 001	274	05 057603 001	293	05 057908 001	332	05 059572 001	288
05 056810 001	274	05 057604 001	293	05 058005 001	278	05 059573 001	297
05 056812 001	274	05 057605 001	293	05 058010 001	278	05 059574 001	269
05 056815 001	274	05 057606 001	293	05 058015 001	278	05 059575 001	278
05 056820 001	274	05 057615 001	260	05 058020 001	278	05 059602 001	297
05 056825 001	274	05 057616 001	260	05 059030 001	77	05 059603 001	297
05 056835 001	274	05 057617 001	260	05 059040 001	71	05 059604 001	297
05 056910 001	274	05 057620 001	271	05 059041 001	70	05 059605 001	297
05 056915 001	274	05 057621 001	271	05 059291 001	74	05 059610 001	297
05 056925 001	274	05 057622 001	271	05 059293 001	209	05 059615 001	297
05 057110 001	213	05 057623 001	279	05 059294 001	211	05 059620 001	297
05 057111 001	213	05 057624 001	279	05 059295 001	211	05 059625 001	297
05 057115 001	334	05 057625 001	279	05 059297 001	212	05 059628 001	297

Code No.	Page	Code No.	Page	Code No.	Page	Code No.	Page
05 059629 001	297	05 059920 001	277	05 060175 001	302	05 060409 001	305
05 059630 001	297	05 059922 001	277	05 060180 001	302	05 060410 001	305
05 059631 001	297	05 059924 001	277	05 060182 001	302	05 060411 001	305
05 059632 001	297	05 060005 001	277	05 060184 001	302	05 060412 001	305
05 059633 001	297	05 060010 001	277	05 060185 001	286	05 060420 001	306
05 059634 001	297	05 060015 001	277	05 060186 001	286	05 060421 001	306
05 059635 001	297	05 060027 001	278	05 060187 001	286	05 060422 001	306
05 059636 001	297	05 060029 001	278	05 060188 001	286	05 060423 001	306
05 059637 001	297	05 060030 001	278	05 060189 001	286	05 060424 001	306
05 059640 001	299	05 060031 001	278	05 060190 001	286	05 060425 001	306
05 059641 001	299	05 060033 001	278	05 060191 001	286	05 060426 001	306
05 059642 001	299	05 060035 001	278	05 060192 001	286	05 060427 001	306
05 059643 001	299	05 060036 001	278	05 060193 001	286	05 060428 001	306
05 059644 001	299	05 060037 001	278	05 060194 001	286	05 060429 001	306
05 059645 001	299	05 060038 001	278	05 060195 001	286	05 060430 001	306
05 059660 001	297	05 060041 001	278	05 060196 001	286	05 060431 001	306
05 059661 001	297	05 060043 001	278	05 060197 001	286	05 060432 001	306
05 059662 001	297	05 060045 001	278	05 060198 001	286	05 060505 001	285
05 059663 001	297	05 060047 001	278	05 060199 001	286	05 060506 001	285
05 059664 001	297	05 060048 001	288	05 060200 001	286	05 060507 001	285
05 059665 001	297	05 060049 001	288	05 060201 001	286	05 060508 001	285
05 059666 001	297	05 060050 001	288	05 060202 001	286	05 060509 001	285
05 059667 001	297	05 060051 001	288	05 060210 001	306	05 060510 001	285
05 059668 001	297	05 060052 001	288	05 060215 001	306	05 060511 001	285
05 059680 001	298	05 060053 001	288	05 060220 001	306	05 060512 001	285
05 059681 001	298	05 060054 001	288	05 060225 001	306	05 060513 001	285
05 059682 001	298	05 060055 001	277	05 060230 001	306	05 060514 001	285
05 059683 001	298	05 060056 001	288	05 060235 001	306	05 060515 001	285
05 059700 001	285	05 060057 001	288	05 060237 001	306	05 060516 001	285
05 059701 001	285	05 060060 001	277	05 060238 001	306	05 060517 001	285
05 059702 001	285	05 060065 001	277	05 060240 001	306	05 064155 001	287
05 059703 001	285	05 060098 001	286	05 060255 001	306	05 064170 001	287
05 059704 001	285	05 060100 001	286	05 060260 001	306	05 064175 001	287
05 059705 001	285	05 060105 001	286	05 060265 001	306	05 065081 001	270
05 059720 001	279	05 060110 001	286	05 060272 001	305	05 065096 001	278
05 059721 001	279	05 060115 001	286	05 060274 001	305	05 065110 001	270
05 059755 001	269	05 060120 001	286	05 060276 001	305	05 065112 001	270
05 059760 001	269	05 060125 001	286	05 060278 001	305	05 065114 001	270
05 059765 001	269	05 060130 001	286	05 060280 001	305	05 065129 001	278
05 059766 001	269	05 060131 001	286	05 060281 001	305	05 065197 001	270
05 059770 001	269	05 060132 001	286	05 060282 001	305	05 066081 001	284
05 059775 001	269	05 060133 001	286	05 060283 001	305	05 066082 001	284
05 059780 001	269	05 060134 001	286	05 060284 001	305	05 066083 001	284
05 059785 001	269	05 060135 001	286	05 060286 001	305	05 066100 001	281
05 059786 001	269	05 060136 001	286	05 060288 001	305	05 066102 001	281
05 059790 001	269	05 060137 001	286	05 060290 001	305	05 066104 001	281
05 059795 001	269	05 060138 001	286	05 060296 001	303	05 066106 001	281
05 059800 001	269	05 060139 001	288	05 060297 001	303	05 066108 001	281
05 059802 001	269	05 060140 001	288	05 060298 001	303	05 066110 001	281
05 059805 001	268	05 060141 001	288	05 060300 001	303	05 066120 001	281
05 059810 001	268	05 060142 001	288	05 060301 001	303	05 066122 001	281
05 059815 001	268	05 060143 001	288	05 060302 001	303	05 066124 001	281
05 059855 001	268	05 060144 001	288	05 060303 001	303	05 066126 001	281
05 059860 001	268	05 060145 001	288	05 060304 001	303	05 066128 001	281
05 059865 001	268	05 060146 001	288	05 060400 001	305	05 066130 001	281
05 059896 001	279	05 060147 001	302	05 060401 001	305	05 066140 001	281
05 059897 001	279	05 060148 001	302	05 060402 001	305	05 066141 001	281
05 059900 001	276	05 060149 001	302	05 060403 001	305	05 066142 001	281
05 059902 001	276	05 060150 001	302	05 060404 001	305	05 066143 001	281
05 059904 001	276	05 060155 001	302	05 060405 001	305	05 066144 001	281
05 059910 001	276	05 060160 001	302	05 060406 001	305	05 066145 001	281
05 059912 001	276	05 060165 001	302	05 060407 001	305	05 066150 001	304
05 059914 001	276	05 060170 001	302	05 060408 001	305	05 066155 001	304



Code No. Index

Code No.	Page	Code No.	Page	Code No.	Page	Code No.	Page
05 066160 001	304	05 066530 001	287	05 066915 001	287	05 072055 001	291
05 066165 001	304	05 066618 001	303	05 066920 001	287	05 072057 001	291
05 066170 001	304	05 066619 001	303	05 066925 001	287	05 072059 001	291
05 066272 001	289	05 066620 001	303	05 066941 001	287	05 072061 001	291
05 066274 001	289	05 066622 001	303	05 066950 001	287	05 072063 001	291
05 066276 001	289	05 066624 001	303	05 071010 001	260	05 072065 001	291
05 066278 001	289	05 066626 001	303	05 071011 001	260	05 072070 001	264
05 066279 001	289	05 066628 001	303	05 071012 001	260	05 072072 001	264
05 066280 001	289	05 066628 001	303	05 071020 001	272	05 072074 001	264
05 066282 001	289	05 066630 001	303	05 071021 001	272	05 072080 001	274
05 066284 001	289	05 066632 001	303	05 071022 001	272	05 072082 001	274
05 066286 001	289	05 066633 001	303	05 071022 001	272	05 072084 001	274
05 066287 001	289	05 066634 001	303	05 071030 001	280	05 072084 001	274
05 066288 001	289	05 066635 001	303	05 071032 001	280	05 072400 001	264
05 066288 001	289	05 066638 001	303	05 071032 001	280	05 072401 001	264
05 066290 001	289	05 066638 001	303	05 071033 001	280	05 072402 001	264
05 066300 001	282	05 066640 001	303	05 071034 001	280	05 072402 001	264
05 066301 001	282	05 066642 001	303	05 071035 001	280	05 072403 001	275
05 066302 001	282	05 066644 001	303	05 071037 001	280	05 072404 001	275
05 066302 001	282	05 066646 001	303	05 071038 001	280	05 072405 001	275
05 066303 001	282	05 066654 001	304	05 071038 001	280	05 072406 001	283
05 066304 001	282	05 066656 001	304	05 071070 001	293	05 072406 001	283
05 066305 001	282	05 066660 001	304	05 071071 001	293	05 072407 001	283
05 066308 001	282	05 066662 001	304	05 071072 001	293	05 072408 001	283
05 066310 001	282	05 066662 001	304	05 071073 001	293	05 072409 001	283
05 066312 001	282	05 066664 001	304	05 071073 001	293	05 072409 001	283
05 066312 001	282	05 066664 001	304	05 071074 001	293	05 072411 001	283
05 066313 001	282	05 066666 001	304	05 071075 001	293	05 072412 001	283
05 066315 001	282	05 066666 001	304	05 071075 001	293	05 072412 001	283
05 066320 001	282	05 066668 001	304	05 071076 001	293	05 072441 001	265
05 066325 001	282	05 066670 001	304	05 071077 001	293	05 072443 001	275
05 066330 001	282	05 066672 001	304	05 071080 001	291	05 072444 001	275
05 066335 001	282	05 066674 001	304	05 071081 001	266	05 072446 001	283
05 066339 001	300	05 066676 001	304	05 071082 001	266	05 072447 001	283
05 066395 001	301	05 066678 001	304	05 071083 001	266	05 072448 001	283
05 066396 001	300	05 066680 001	304	05 071084 001	276	05 072449 001	283
05 066400 001	301	05 066682 001	304	05 071085 001	276	05 072451 001	283
05 066405 001	301	05 066683 001	304	05 071086 001	276	05 072452 001	283
05 066410 001	301	05 066684 001	304	05 071089 001	288	05 073050 001	295
05 066415 001	301	05 066685 001	304	05 071090 001	288	05 073051 001	295
05 066420 001	301	05 066686 001	304	05 071091 001	288	05 073052 001	295
05 066455 001	283	05 066687 001	304	05 071092 001	288	05 073053 001	295
05 066460 001	283	05 066688 001	303	05 071094 001	288	05 073054 001	295
05 066465 001	283	05 066690 001	303	05 071097 001	302	05 073055 001	295
05 066485 001	282	05 066692 001	303	05 071098 001	302	05 073056 001	297
05 066486 001	282	05 066694 001	303	05 071099 001	302	05 073057 001	297
05 066487 001	282	05 066696 001	303	05 071100 001	311	05 073058 001	297
05 066488 001	282	05 066758 001	304	05 071101 001	296	05 073059 001	297
05 066489 001	282	05 066760 001	304	05 071102 001	296	05 073060 001	297
05 066490 001	282	05 066762 001	304	05 071103 001	296	05 073061 001	297
05 066491 001	282	05 066764 001	304	05 071104 001	296	05 073064 001	288
05 066492 001	282	05 066766 001	304	05 071105 001	296	05 073065 001	288
05 066493 001	282	05 066768 001	304	05 071106 001	296	05 073066 001	288
05 066494 001	282	05 066785 001	304	05 071107 001	296	05 073070 001	289
05 066495 001	282	05 066786 001	304	05 071107 001	296	05 073071 001	289
05 066496 001	282	05 066787 001	304	05 071108 001	296	05 073072 001	289
05 066497 001	287	05 066788 001	304	05 071109 001	325	05 073073 001	289
05 066498 001	287	05 066788 001	304	05 071110 001	325	05 073073 001	289
05 066499 001	287	05 066788 001	304	05 071110 001	325	05 073074 001	301
05 066500 001	287	05 066850 001	304	05 071116 001	209	05 073074 001	301
05 066505 001	287	05 066851 001	304	05 071117 001	210	05 073075 001	301
05 066510 001	287	05 066852 001	304	05 071222 001	305	05 073076 001	302
05 066515 001	287	05 066853 001	304	05 071223 001	305	05 073077 001	302
05 066520 001	287	05 066854 001	304	05 071224 001	305	05 073200 001	317
05 066525 001	287	05 066900 001	287	05 071225 001	305	05 073201 001	299
		05 066901 001	287	05 071228 001	305	05 073202 001	299
		05 066902 001	287	05 072014 001	383	05 073210 001	316
		05 066905 001	287	05 072017 001	383	05 073220 001	160
		05 066910 001	287	05 072050 001	291	05 073230 001	164

Code No.	Page	Code No.	Page	Code No.	Page	Code No.	Page
05 073240 001	207	05 073376 001	282	05 073634 001	325	05 074717 001	355
05 073241 001	207	05 073380 001	275	05 073635 001	336	05 074717 010	359
05 073260 001	98	05 073391 001	185	05 073637 001	337	05 074720 001	356
05 073261 001	116	05 073401 001	314	05 073638 001	337	05 074720 010	361
05 073262 001	134	05 073404 001	335	05 073640 001	157	05 074721 001	357
05 073268 001	168	05 073406 001	335	05 073645 001	161	05 074721 010	361
05 073270 001	168	05 073410 001	333	05 073660 001	235	05 074722 001	356
05 073271 001	168	05 073416 001	334	05 073661 002	235	05 074722 010	361
05 073272 001	168	05 073418 001	328	05 073665 001	234	05 074728 001	355
05 073273 001	168	05 073419 001	330	05 073670 001	56	05 074728 010	359
05 073274 001	168	05 073420 001	311	05 073671 001	56	05 074730 001	350
05 073275 001	168	05 073421 001	312	05 073675 001	38	05 074731 001	350
05 073276 001	168	05 073470 001	286	05 073676 001	39	05 074733 001	351
05 073277 001	168	05 073471 001	286	05 073677 001	39	05 074734 001	351
05 073278 001	168	05 073472 001	286	05 073680 001	32	05 074738 001	352
05 073279 001	168	05 073473 001	286	05 073681 001	32	05 074739 001	352
05 073280 001	168	05 073474 001	286	05 073720 001	286	05 074745 001	353
05 073281 001	168	05 073495 001	307	05 073721 001	286	05 074746 001	353
05 073282 001	168	05 073500 001	306	05 073722 001	286	05 074750 001	79
05 073283 001	168	05 073501 001	306	05 073723 001	286	05 074752 001	79
05 073284 001	168	05 073502 001	306	05 073724 001	286	05 074757 001	79
05 073285 001	168	05 073503 001	306	05 073890 001	324	05 074770 001	350
05 073286 001	168	05 073504 001	306	05 073904 001	293	05 074772 001	350
05 073287 001	168	05 073505 001	306	05 073905 001	293	05 074774 001	350
05 073290 001	169	05 073506 001	306	05 073906 001	293	05 074780 001	350
05 073295 001	170	05 073507 001	306	05 073916 001	260	05 074782 001	350
05 073304 001	264	05 073508 001	306	05 073917 001	260	05 074784 001	350
05 073305 001	264	05 073509 001	306	05 073921 001	271	05 074786 001	351
05 073306 001	264	05 073510 001	306	05 073922 001	271	05 074788 001	351
05 073307 001	264	05 073511 001	312	05 073924 001	279	05 074790 001	354
05 073308 001	275	05 073520 001	269	05 073925 001	279	05 074790 010	358
05 073309 001	275	05 073521 001	269	05 073926 001	279	05 074792 001	354
05 073310 001	275	05 073522 001	269	05 073927 001	279	05 074792 010	358
05 073311 001	275	05 073523 001	278	05 073931 001	300	05 074794 001	354
05 073313 001	282	05 073524 001	278	05 073932 001	300	05 074794 010	358
05 073314 001	282	05 073525 001	278	05 073944 001	296	05 074800 001	358
05 073315 001	282	05 073526 001	286	05 073945 001	296	05 074800 010	363
05 073316 001	282	05 073527 001	286	05 073946 001	296	05 074802 001	351
05 073317 001	282	05 073528 001	286	05 073956 001	266	05 074804 001	351
05 073318 001	313	05 073529 001	286	05 073957 001	266	05 074810 001	358
05 073323 001	264	05 073530 001	286	05 073961 001	276	05 074810 010	363
05 073324 001	264	05 073531 001	286	05 073962 001	276	05 074820 001	355
05 073325 001	264	05 073540 001	231	05 073964 001	284	05 074820 010	360
05 073326 001	264	05 073541 001	230	05 073965 001	284	05 074822 001	355
05 073332 001	261	05 073544 001	183	05 073966 001	284	05 074822 010	360
05 073333 001	261	05 073593 001	184	05 073967 001	284	05 074824 001	355
05 073334 001	261	05 073594 001	186	05 073971 001	302	05 074824 010	360
05 073335 001	261	05 073596 001	186	05 073972 001	302	05 074826 001	357
05 073336 001	273	05 073598 001	196	05 073980 001	323	05 074826 010	362
05 073337 001	273	05 073599 001	196	05 073984 001	58	05 074828 001	357
05 073338 001	273	05 073610 001	261	05 073990 001	310	05 074828 010	362
05 073339 001	273	05 073611 001	261	05 074700 001	350	05 074840 001	356
05 073340 001	282	05 073613 001	272	05 074701 001	350	05 074840 010	360
05 073342 001	295	05 073614 001	272	05 074702 001	350	05 074842 001	356
05 073344 001	295	05 073615 001	272	05 074705 001	350	05 074842 010	360
05 073346 001	282	05 073616 001	311	05 074710 001	350	05 075604 001	364
05 073357 001	315	05 073620 001	280	05 074711 001	350	05 075605 001	365
05 073370 001	274	05 073621 001	280	05 074712 001	351	05 075610 001	366
05 073371 001	274	05 073622 001	280	05 074715 001	354	05 075611 001	367
05 073372 001	274	05 073623 001	280	05 074715 010	359	05 075620 001	367
05 073373 001	274	05 073625 001	280	05 074716 001	354	05 075621 001	367
05 073375 001	282	05 073630 001	325	05 074716 010	359	05 075622 001	367



Code No. Index

Code No.	Page	Code No.	Page	Code No.	Page	Code No.	Page
05 075623 001	369	05 078641 001	377	05 078720 001	379	05 104619 001	345
05 075624 001	369	05 078642 001	377	05 078721 001	379	05 104620 001	345
05 075625 001	369	05 078650 001	378	05 100000 001	61	05 104621 001	345
05 075626 001	370	05 078651 001	378	05 100001 001	61	05 104622 001	345
05 075630 001	369	05 078652 001	378	05 100002 001	61	05 104630 001	344
05 075631 001	370	05 078653 001	378	05 100003 001	61	05 104631 001	344
05 075651 001	370	05 078654 001	378	05 100004 001	61	05 104632 001	344
05 075652 001	370	05 078655 001	378	05 100011 001	61	05 104633 001	344
05 075653 001	371	05 078656 001	378	05 100012 001	61	05 104634 001	344
05 075654 001	371	05 078657 001	378	05 100015 001	62	05 104635 001	344
05 075655 001	371	05 078658 001	378	05 100016 001	62	05 104640 001	345
05 075656 001	371	05 078660 001	378	05 100019 001	62	05 104641 001	345
05 075670 001	372	05 078661 001	378	05 100020 001	62	05 104642 001	345
05 075670 010	372	05 078662 001	378	05 100021 001	63	05 104643 001	345
05 075671 001	372	05 078663 001	378	05 100022 001	63	05 104644 001	345
05 075671 010	372	05 078664 001	378	05 100024 001	64	05 104645 001	345
05 075672 001	372	05 078666 001	379	05 100025 001	64	05 104650 001	344
05 075672 010	372	05 078667 001	379	05 100026 001	64	05 104651 001	345
05 075673 001	373	05 078670 001	374	05 100030 001	13	05 104652 001	346
05 075673 010	373	05 078671 001	374	05 100031 001	13	05 104653 001	346
05 075680 001	368	05 078672 001	374	05 100042 001	12	05 104654 001	343
05 075681 001	368	05 078673 001	374	05 100043 001	12	05 104655 001	343
05 075800 001	381	05 078674 001	374	05 100044 001	12	05 104660 001	343
05 075801 001	381	05 078675 001	374	05 100050 001	14	05 104661 001	343
05 075830 001	381	05 078676 001	374	05 100051 001	14	05 104662 001	343
05 075831 001	382	05 078677 001	374	05 100052 001	14	05 104663 001	343
05 075832 001	382	05 078678 001	374	05 100055 001	14	05 104664 001	343
05 078200 001	376	05 078679 001	374	05 100056 001	14	05 104665 001	343
05 078205 001	376	05 078680 001	374	05 100057 001	14	05 104666 001	342
05 078210 001	376	05 078681 001	374	05 100060 001	16	05 104667 001	342
05 078345 001	377	05 078682 001	374	05 100061 001	16	05 104668 001	342
05 078600 001	373	05 078683 001	374	05 100062 001	16	05 104669 001	342
05 078601 001	373	05 078684 001	374	05 100063 001	16	05 104670 001	342
05 078602 001	373	05 078685 001	374	05 100064 001	16	05 104671 001	342
05 078603 001	373	05 078686 001	374	05 100070 001	18	05 104672 001	342
05 078604 001	373	05 078687 001	374	05 100071 001	18	05 105622 001	23
05 078605 001	373	05 078690 001	375	05 100072 001	18	05 105623 001	24
05 078606 001	373	05 078691 001	375	05 100075 001	9	05 105624 001	25
05 078607 001	373	05 078692 001	375	05 100076 001	9	05 105625 001	25
05 078608 001	373	05 078693 001	375	05 100077 001	9	05 105626 001	26
05 078609 001	373	05 078694 001	375	05 100080 001	9	05 105630 001	21
05 078610 001	373	05 078695 001	375	05 100081 001	9	05 105631 001	65
05 078611 001	373	05 078696 001	375	05 100082 001	9	05 105650 001	23
05 078612 001	373	05 078697 001	375	05 100085 001	8	05 105656 001	23
05 078620 001	374	05 078698 001	375	05 100086 001	8	05 110000 001	12
05 078621 001	374	05 078699 001	375	05 100087 001	8	05 110001 001	12
05 078622 001	374	05 078700 001	375	05 100100 001	64	05 110002 001	12
05 078623 001	374	05 078701 001	375	05 104600 001	345	05 110003 001	12
05 078624 001	374	05 078702 001	375	05 104601 001	345	05 110004 001	12
05 078625 001	374	05 078703 001	375	05 104602 001	345	05 110005 001	12
05 078626 001	374	05 078704 001	375	05 104603 001	345	05 110006 001	12
05 078627 001	374	05 078705 001	375	05 104604 001	345	05 110007 001	12
05 078628 001	374	05 078706 001	380	05 104605 001	345	05 110008 001	12
05 078629 001	374	05 078707 001	376	05 104610 001	345	05 110010 001	13
05 078630 001	374	05 078708 001	376	05 104611 001	345	05 110011 001	13
05 078631 001	374	05 078709 001	380	05 104612 001	345	05 110104 001	13
05 078632 001	374	05 078710 001	377	05 104613 001	345	05 110105 001	13
05 078633 001	374	05 078711 001	380	05 104614 001	345	05 117680 001	18
05 078635 001	375	05 078714 001	379	05 104615 001	345	05 117681 001	18
05 078636 001	375	05 078715 001	379	05 104616 001	345	05 117682 001	18
05 078637 001	375	05 078716 001	379	05 104617 001	345	05 117683 001	18
05 078640 001	377	05 078717 001	379	05 104618 001	345	05 117684 001	18



Code No.	Page	Code No.	Page	Code No.	Page	Code No.	Page
05 117685 001	18	05 118100 001	36	05 134025 001	256	05 134701 001	290
05 117686 001	18	05 118102 001	36	05 134025 001	256	05 134702 001	290
05 117687 001	18	05 118103 001	36	05 134200 001	333	05 134703 001	290
05 117691 001	18	05 118106 001	36	05 134275 001	28	05 134704 001	290
05 117990 001	34	05 118108 001	37	05 134370 001	267	05 134705 001	290
05 117991 001	34	05 118109 001	37	05 134371 001	267	05 134706 001	290
05 117992 001	34	05 118110 001	37	05 134372 001	267	05 134707 001	290
05 117993 001	34	05 118112 001	37	05 134373 001	267	05 134720 001	290
05 117994 001	34	05 118114 001	37	05 134374 001	281	05 134722 001	290
05 117995 001	34	05 118116 001	37	05 134375 001	281	05 134723 001	290
05 117997 001	34	05 118118 001	37	05 134376 001	281	05 134732 001	290
05 118000 001	34	05 118120 001	37	05 134377 001	281	05 134740 001	286
05 118002 001	34	05 118122 001	37	05 134378 001	281	05 134800 001	302
05 118003 001	34	05 118124 001	37	05 134379 001	281	05 134801 001	302
05 118004 001	34	05 118126 001	37	05 134380 001	268	05 134802 001	302
05 118005 001	34	05 118128 001	37	05 134381 001	268	05 134805 001	302
05 118006 001	34	05 118130 001	37	05 134382 001	268	05 134806 001	302
05 118007 001	34	05 118132 001	37	05 134384 001	277	05 134807 001	302
05 118008 001	34	05 118134 001	37	05 134385 001	277	05 134905 001	264
05 118010 001	34	05 118135 001	37	05 134386 001	277	05 134906 001	267
05 118012 001	34	05 118136 001	37	05 134397 001	315	05 134907 001	267
05 118014 001	34	05 118137 001	37	05 134398 001	315	05 134910 001	267
05 118017 001	34	05 118145 001	36	05 134399 001	317	05 134911 001	267
05 118019 001	35	05 118150 001	40	05 134480 001	314	05 134913 001	267
05 118020 001	35	05 118152 001	40	05 134491 001	208	05 134914 001	267
05 118022 001	35	05 118154 001	41	05 134605 001	270	05 134915 001	267
05 118023 001	35	05 118156 001	41	05 134609 001	289	05 134919 001	262
05 118024 001	35	05 118158 001	41	05 134654 001	290	05 134920 001	262
05 118026 001	35	05 118180 001	35	05 134655 001	290	05 134921 001	262
05 118030 001	34	05 118181 001	35	05 134656 001	290	05 134929 001	267
05 118032 001	34	05 118182 001	35	05 134657 001	290	05 134930 001	267
05 118035 001	35	05 118183 001	35	05 134658 001	290	05 134931 001	267
05 118036 001	35	05 118184 001	35	05 134664 001	289	05 134932 001	267
05 118037 001	35	05 118185 001	35	05 134665 001	289	05 135003 001	274
05 118039 001	35	05 118186 001	35	05 134667 001	289	05 135005 001	263
05 118040 001	35	05 130002 001	316	05 134668 001	289	05 135008 001	263
05 118042 001	35	05 130003 001	316	05 134669 001	289	05 135009 001	263
05 118044 001	35	05 130110 001	365	05 134670 001	289	05 135017 001	274
05 118046 001	35	05 133150 001	193	05 134671 001	289	05 135040 001	265
05 118048 001	35	05 133151 001	193	05 134672 001	289	05 135041 001	265
05 118050 001	35	05 133152 001	193	05 134673 001	289	05 135060 001	294
05 118052 001	35	05 133153 001	193	05 134674 001	289	05 135068 001	294
05 118054 001	35	05 133154 001	193	05 134675 001	289	05 135069 001	294
05 118060 001	36	05 133155 001	193	05 134676 001	289	05 135070 001	294
05 118062 001	36	05 133156 001	193	05 134677 001	289	05 135071 001	294
05 118064 001	36	05 133157 001	193	05 134678 001	289	05 135072 001	294
05 118066 001	36	05 133158 001	193	05 134679 001	289	05 135073 001	294
05 118068 001	36	05 133163 001	186	05 134680 001	289	05 135074 001	294
05 118070 001	36	05 133164 001	184	05 134681 001	289	05 135075 001	294
05 118072 001	36	05 133180 001	188	05 134682 001	289	05 135076 001	294
05 118074 001	36	05 133285 001	10	05 134683 001	289	05 135077 001	294
05 118075 001	36	05 133355 001	67	05 134684 001	289	05 135078 001	294
05 118076 001	36	05 133356 001	66	05 134685 001	289	05 135079 001	294
05 118078 001	36	05 133862 001	154	05 134686 001	289	05 135090 001	297
05 118080 001	36	05 134000 001	38	05 134687 001	289	05 135091 001	297
05 118082 001	36	05 134001 001	32	05 134688 001	289	05 135092 001	297
05 118089 001	36	05 134002 001	32	05 134690 001	289	05 135093 001	297
05 118090 001	36	05 134011 001	255	05 134691 001	289	05 135094 001	297
05 118092 001	36	05 134013 001	229	05 134695 001	289	05 135095 001	297
05 118094 001	36	05 134015 001	229	05 134698 001	290	05 135096 001	297
05 118096 001	36	05 134019 001	52	05 134699 001	290	05 135097 001	297
05 118098 001	36	05 134021 001	347	05 134700 001	290	05 135098 001	297



Code No. Index

Code No.	Page	Code No.	Page	Code No.	Page	Code No.	Page
05 135099 001	297	05 136011 001	347	05 150120 001	245	05 345032 001	287
05 135120 001	289	05 136013 001	67	05 150121 001	246	05 345035 001	287
05 135121 001	289	05 136018 001	68	05 150122 001	246	05 345047 001	286
05 135140 001	282	05 136019 001	69	05 150130 001	240	05 345056 001	287
05 135141 001	282	05 136022 001	68	05 150140 001	247	05 345281 001	37
05 135142 001	282	05 136026 001	228	05 150150 001	247	05 345282 001	37
05 135143 001	282	05 136027 001	76	05 150180 001	248	05 345284 001	36
05 135200 001	286	05 136301 001	297	05 150181 001	248	05 345285 001	36
05 135201 001	286	05 136302 001	297	05 150182 001	249	05 345290 001	35
05 135202 001	286	05 136303 001	297	05 150183 001	249	05 345350 001	287
05 135204 001	286	05 136304 001	297	05 160785 001	97	05 345351 001	287
05 135205 001	286	05 136305 001	269	05 160821 001	290	05 345352 001	287
05 135220 001	287	05 136306 001	269	05 160830 001	286	05 346281 001	263
05 135221 001	287	05 136307 001	269	05 160885 001	297	05 346288 001	297
05 135222 001	287	05 136308 001	278	05 160895 001	270	05 346293 001	157
05 135224 001	307	05 136309 001	278	05 160896 001	268	05 347100 001	315
05 135225 001	307	05 136310 001	278	05 160899 001	268	05 347106 001	22
05 135230 001	289	05 136311 001	286	05 160901 001	270	05 347107 001	76
05 135231 001	289	05 136312 001	286	05 160908 001	270	05 347108 001	75
05 135232 001	289	05 136313 001	286	05 160917 001	289	05 347153 001	328
05 135233 001	289	05 136314 001	286	05 160924 001	315	05 347735 002	24
05 135234 001	289	05 136315 001	286	05 160956 001	289	05 347736 002	24
05 135235 001	289	05 136316 001	286	05 160976 001	315	05 347743 001	14
05 135264 001	292	05 136385 001	327	05 160977 001	315	05 347777 001	67
05 135265 001	292	05 136390 001	340	05 160979 001	315	05 350430 001	297
05 135266 001	292	05 136391 001	340	05 160981 001	315	05 350451 001	352
05 135267 001	292	05 136392 001	329	05 160983 001	267	05 380033 001	297
05 135268 001	298	05 136393 001	342	05 200496 001	287	05 380045 001	297
05 135269 001	298	05 136400 001	155	05 200995 001	160	05 380046 001	297
05 135270 001	270	05 136420 001	111	05 203913 001	269	05 380047 001	297
05 135271 001	270	05 136421 001	131	05 203914 001	269	05 380048 001	297
05 135272 001	270	05 136422 001	156	05 204126 001	290	05 380049 001	297
05 135273 001	270	05 136424 001	48	05 221110 001	304	05 380050 001	297
05 135276 001	270	05 136425 001	48	05 223161 001	26	05 380124 001	298
05 135277 001	270	05 136426 001	49	05 259135 001	290	05 380125 001	298
05 135280 001	271	05 137811 001	10	05 300004 001	54	05 380126 001	298
05 135281 001	271	05 137812 001	10	05 308428 001	286	05 380127 001	298
05 135284 001	271	05 137813 001	10	05 311517 001	316	05 380128 001	298
05 135285 001	271	05 138070 001	15	05 319835 001	286	05 380129 001	298
05 135311 001	28	05 138250 001	27	05 320430 001	289	05 380130 001	298
05 135530 001	268	05 138257 001	17	05 320540 001	24	05 380131 001	298
05 135531 001	268	05 138258 001	17	05 323780 001	269	05 380161 001	267
05 135532 001	268	05 138259 001	17	05 323781 001	269	05 380200 001	268
05 135810 001	335	05 138260 001	17	05 324901 001	303	05 380201 001	268
05 135870 001	225	05 138261 001	17	05 326310 001	289	05 380202 001	268
05 135871 001	225	05 138262 001	17	05 328448 001	286	05 480172 001	264
05 135903 001	307	05 138263 001	17	05 332600 001	286	05 480222 001	274
05 135904 001	307	05 138264 001	17	05 332606 001	289	05 670446 001	257
05 135906 001	74	05 138265 001	17	05 332607 001	287	05 670447 001	257
05 135918 001	158	05 138266 001	17	05 332609 001	287	05 670448 001	257
05 135926 001	224	05 138268 001	17	05 332610 001	287		
05 135927 001	228	05 138269 001	17	05 340245 001	300		
05 135928 001	227	05 138270 001	17	05 340330 001	13		
05 135938 001	40	05 140310 001	237	05 344511 001	319		
05 135939 001	226	05 150101 001	241	05 344512 001	319		
05 135942 001	203	05 150102 001	242	05 344513 001	319		
05 135949 001	96	05 150103 001	242	05 344514 001	319		
05 135961 001	67	05 150104 001	243	05 344900 001	289		
05 135973 001	55	05 150110 001	243	05 345018 001	287		
05 136000 001	316	05 150111 001	244	05 345019 001	289		
05 136001 001	317	05 150112 001	244	05 345026 001	287		
05 136002 001	317	05 150113 001	245	05 345028 001	287		



Article No. Index

68	237	334 SK	13	454/10 HF Set Imperial 2	46
80	236	334 SK/6	22	467 TORX® HF	42
80 RA	233	334/355/6 Rack	23	467/7 TORX® Set 1	47
81	237	334/355 SK/6	23	467/7 TORX® Set 2	47
82	237	334/368/6	27	495	43
83	237	335	12	712	236
84	237	335 SB	12	780 A	319
85	237	335 Stubby/carburetor screwdriver	20	780 B	319
86	237	335/350/355/3	24	780 C	319
87	237	335/350/355/4	24	781 A	318
88/1	235	335/350/355/6	23	781 B	318
91	236	335/350/367/7	24	781 C	318
95 Vario	236	338	18	781/5 Set 1	318
100	383	338/2	27	784 A/1	319
100 L	384	350	13	784 B	319
100 S	384	350 SB	14	784 C	319
101	384	350 SK	13	800 S	220
101 L	384	350 PH Stubby/carburetor screwdriver	20	800/1 BDC	290
102	384	352	15	800/1 BTZ	291
102 L	384	354	15	800/1 TZ	291
160 i VDE	60	355	14	800/1 Z	291
160 i VDE SB	61	355 SB	14	800/2 Z	292
160 i/6	65	355 SK	14	800/4 Z	292
160 i/7	66	355 Stubby/carburetor screwdriver	20	800/4 Z Take it easy	292
160 i/162 i/167 i/9	67	367 TORX®	16	800/9 C	292
160 i/165 i/7	66	367 TORX® SB	16	809/1 ESD Stubby	57
160 i/168 i/6	67	367/6 TORX®	27	810/1 Vario	232
160 iS VDE	61	367 TORX® Stubby/carburetor screwdriver	20	811/1 ESD Stubby	57
160 iS/7	66	367 TORX® B0	17	811/1 Stubby	232
160 iSS	61	367 TORX® HF	16	812/1 Vario	232
160 iSS/7	67	367/4 TORX® HF	26	813	232
162 i PH/S VDE	62	367/6 TORX® B0	27	813 R	231
162 i PH/S VDE SB	62	367/6 TORX® HF	26	813 R ESD	54
162 i VDE PH	61	367/6 TORX® HF	26	816 R	231
162 i VDE PH SB	61	367/7 TORX® HF	26	816 R SB	231
162 iS PH VDE	61	367 TORX PLUS®	17	816 R ESD	54
162 iS PH/S VDE	63	368	18	816 RA	233
162 iSS PH VDE	62	368 SB	18	817 R	230
165 i PZ VDE	62	368 Stubby/carburetor screwdriver	21	817 R SB	230
165 i PZ VDE SB	62	391	18	817 VDE	79
165 i PZ/S VDE	63	391/3	28	826 T Krafftform Turbo	203
165 i PZ/S VDE SB	63	392	231	827 T Krafftform Turbo	80
165 iS PZ VDE	62	393 S	231	830	236
165 iS PZ/S VDE	63	395	19	840 S Hex-Plus	219
165 iS PZ/S VDE # 1 + 2	69	395 H0	19	840/1 BTZ	294
165 iSS PZ/S VDE	63	395 H0/3	28	840/1 IMP DC Hex-Plus 3,0 x 25 mm DIY	293
167 i TORX® VDE	64	395 H0/7 SM	28	840/1 IMP DC Hex-Plus 4,0 x 25 mm DIY	293
167 i/6 TORX® VDE	66	400 Hex	364	840/1 IMP DC Hex-Plus 5,0 x 25 mm DIY	293
168 i VDE	64	400 i Hex	91	840/1 IMP DC Hex-Plus 6,0 x 25 mm DIY	293
168 i VDE SB	64	400 TX	364	840/1 IMP DC SB	293
190 i VDE	64	410 i VDE B	86	840/1 Z	294
247	64	411 A RA	44	840/1 Z SB	295
247 SB	64	416 R	43	840/1 Z B0	298
300 Hex	363	416 RA	44	840/2 Z	298
300 IP	363, 364	454	41	840/4 Hex-Plus Ni	297
300 TX	363	454 Imperial	42	840/4 IMP DC Hex-Plus 4,0 x 50 mm DIY	295
300/7 Mix 1	29	454 HF	42	840/4 IMP DC Hex-Plus 5,0 x 50 mm DIY	295
300/7 Mix 2	30	454 Imperial HF	42	840/4 IMP DC Hex-Plus 6,0 x 50 mm DIY	295
334	13	454/7 HF Set 1	45	840/4 IMP DC SB	296
334 SB	13	454/7 HF Set 2	45	840/4 Z	297
334/6	23	454/10 HF Set Imperial 1	46	840/4 Z SB	297



Article No. Index

840/4 Z Hex-Plus Take it easy	296	851/11	270	867/1 TZ TORX®	282
840/4 Z B0	299	851/12	270	867/1 ZA TORX®	284
840/9 C	298	851/16	270	867/1 Z TORX® B0	287
842/1 Z	295	851/21 J	271	867/1 Z TORX® B0 SB	288
842/4	298	853/4 ACR® Harpoon	270	867/1 Z TORX® W	283
843	342	853/4 ACR® SL	269	867/2 Z TORX®	287
844	342	855 S	219	867/4 IMP DC TORX® 20 x 50 mm DIY	284
844/7	343	855/1 BDC	272	867/4 IMP DC TORX® 25 x 50 mm DIY	284
845	343	855/1 BDC SB	273	867/4 IMP DC TORX® 30 x 50 mm DIY	284
845/8	343	855/1 BTH	273	867/4 IMP DC TORX® 40 x 50 mm DIY	284
846 HSS	344	855/1 BTZ	273	867/4 IMP DC TORX® SB	284
846/8	344	855/1 IMP DC PZ 1 x 25 mm DIY	271	867/4 TORX® HF	285
847 HSS	345	855/1 IMP DC PZ 2 x 25 mm DIY	271	867/4 TORX® KK	285
847/7 HSS	345	855/1 IMP DC PZ 3 x 25 mm DIY	271	867/4 Z TORX®	286
848 HSS	345	855/1 IMP DC SB	271	867/4 Z TORX® SB	286
848/851/867/19	346	855/1 RZ	274	867/9 C TORX®	287
849 HSS	345	855/1 TH	274	867/12 TORX®	287
849/855/867/18	346	855/1 TH SB	274	867/15 TORX®	287
851 S	218	855/1 TiN	274	867/4 Z TORX® B0	288
851/1 A	262	855/1 TZ	274	867/4 Z TORX® B0 SB	289
851/1 BDC	261	855/1 Z	274	867/4 Z TORX® B0 Take it easy	288
851/1 BDC SB	261	855/1 Z DIY	275	867/1 IP TORX PLUS®	289
851/1 BTH	261	855/1 Z DIY 100	275	867/4 IP TORX PLUS®	289
851/1 BTZ	262	855/1 Z SB	275	867/9 C IP TORX PLUS®	289
851/1 IMP DC PH 1 x 25 mm DIY	260	855/2 Z	278	867/1 IPR TORX PLUS®	290
851/1 IMP DC PH 2 x 25 mm DIY	260	855/4 BDC	276	867/4 IPR TORX PLUS®	290
851/1 IMP DC PH 3 x 25 mm DIY	260	855/4 BTH	276	868 S	220
851/1 IMP DC SB	260	855/4 BTZ	277	868/1 IMP DC # 2 x 25 mm DIY	300
851/1 J	265	855/4 IMP DC PZ 2 x 50 mm DIY	275	868/1 IMP DC # 3 x 25 mm DIY	300
851/1 RDC	263	855/4 IMP DC SB	276	868/1 IMP DC SB	300
851/1 RH	263	855/4 PZ Ni	278	868/1 V	300
851/1 RZ	263	855/4 TH	277	868/1 Z	301
851/1 RZ SB	263	855/4 TZ	277	868/1 Z SB	301
851/1 TH	263	855/4 TZ SB	277	868/4	302
851/1 TiN	264	855/4 Z	278	868/4 SB	302
851/1 TZ	264	855/4 Z SB	278	868/4 BTZ	302
851/1 TZ SB	264	855/4 Z PZ Take it easy	277	868/4 IMP DC # 2 x 50 mm DIY	301
851/1 Z	264	855/11	278	868/4 IMP DC # 3 x 50 mm DIY	301
851/1 Z DIY	264	855/12	278	868/4 IMP DC SB	302
851/1 Z DIY 100	265	855/4 PZ/S	279	868/4 V	303
851/1 Z SB	264	857/1 Z	305	869/4	305
851/2 Z	270	857/4 Z	305	869/4 M	306
851/4 A	267	860/1 XZN	304	869/4 M SB	306
851/4 BDC	266	867 S TORX®	219	869/4 M SB Set A	307
851/4 BTH	267	867/1 IMP DC TORX 10 x 25 mm DIY	279	869/9	307
851/4 BTZ	267	867/1 IMP DC TORX® 15 x 25 mm DIY	279	870/1	316
851/4 IMP DC PH 2 x 50 mm DIY	265	867/1 IMP DC TORX® 20 x 25 mm DIY	279	870/2	317
851/4 IMP DC PH 3 x 50 mm DIY	265	867/1 IMP DC TORX® 25 x 25 mm DIY	279	870/4	317
851/4 IMP DC SB	266	867/1 IMP DC TORX® 30 x 25 mm DIY	279	870/4 A	316
851/4 J	268	867/1 IMP DC TORX® DIY	279	870/4 SB	317
851/4 PH Ni	269	867/1 IMP DC TORX® SB	279	870/4/7 Set A SB	317
851/4 PH/S	279	867/1 TORX®	282	870/7	317
851/4 R	268	867/1 TORX® BDC	281	870/14	317
851/4 RH	267	867/1 TORX® BDC SB	281	871/1 DC TORQ-SET® Mplus	303
851/4 TH	268	867/1 TORX® BTZ	281	871/1 TORQ-SET® Mplus 25 mm	303
851/4 TZ	268	867/1 TORX® DIY	283	871/1 TORQ-SET® Mplus 32 mm	303
851/4 TZ SB	268	867/1 TORX® DIY 100	283	871/2 TORQ-SET® Mplus	304
851/4 Z	269	867/1 TORX® HF	281	871/4 DC TORQ-SET® Mplus	303
851/4 Z SB	269	867/1 TORX® SB	282		
851/4 Z PH Take it easy	269				
851/9 C	270				

871/4 TORQ-SET® Mplus	304	950 SPKS Multicolour	191	1428	31
872/9	304	950/7 Hex-Plus 1	187	1429	37
875/1 TRI-WING® 25 mm	304	950/7 Hex-Plus Magnet 1	187	1430 ESD	351
875/4 TRI-WING®	304	950/7 Hex-Plus Multicolour Magnet 1	185	1440/1442	32
879/4	307	950/9 Hex-Plus 1	185	1441	32
881/4/1 SB	316	950/9 Hex-Plus 1 SB	185	1460 ESD	358, 363
887/4 RR	312	950/9 Hex-Plus 2	186	1529 ESD	51
887/4 RR SB	312	950/9 Hex-Plus 3	186	1550 ESD Micro	49
888/4/1 K	312	950/9 Hex-Plus 4	186	1550 ESD PH S Micro	50
889/4 R	312	950/9 Hex-Plus 5	186	1550/6 ESD Micro	53
889/4/1	312	950/9 Hex-Plus 6	186	1555 ESD PZ Micro	50
889/4/1 F	313	950/9 Hex-Plus 6 SB	186	1567 ESD TORX® Micro	50
889/4/1 K	312	950/9 Hex-Plus 7	187	1567 ESD TORX® BO Micro	50
889/4/1 K SB	312	950/9 Hex-Plus Imperial 1	188	1567 ESD TORX® HF Micro	50
890/4/1	314	950/9 Hex-Plus Imperial 1 SB	188	1567 ESD TORX PLUS® IPR Micro	50
893/4/1 K	314	950/9 Hex-Plus Multicolour 1	184	1569 ESD Micro	51
893/4/1 K SB	314	950/9 Hex-Plus Multicolour 1 SB	184	1572 ESD Micro	51
894/4/1	313	950/9 Hex-Plus Multicolour 2	184	1573 ESD Micro	51
894/4/1 K	313	950/9 Hex-Plus Multicolour HF 1	183	1578 A ESD Micro	49
895/4/1	313	950/9 Hex-Plus Multicolour HF 1	256	1578 A/6 ESD Micro	53
895/4/1 K	313	950/9 Hex-Plus Multicolour Imperial 1	185	2035 Micro	34
895/4/1 K SB	313	950/9 Hex-Plus Multicolour Imperial 2	185	2035/6 A Micro	40
896/4/1 SB	316	950/9 L Hex-Plus HF 1	185	2035/6 B Micro	40
897/4 IMP R	310	950/13 Hex-Plus Imperial 1	187	2050 Micro	35
897/4 Impaktor	310	950/13 Hex-Plus Imperial 1 SB	188	2050/6 Micro	40
897/4 Impaktor R	310	967 L TORX® HF	199	2052 Micro	36
897/4 R	311	967 PKL TORX®	199	2052/6 Micro	41
897/4 R SB	311	967 PKXL TORX®	198	2054 Micro	36
898/4	314	967 SL TORX® HF	197	2055 Micro	34
898/9	314	967 SPKL TORX® BO Multicolour	198	2067 TORX® Micro	35
898/21	314	967 SPKXL TORX® Multicolour	197	2067 TORX® BO Micro	35
899/3/1	315	967 SXL HF TORX® Multicolour	197	2067/6 TORX® BO Micro	41
899/4/1	315	967 SXL TORX® Multicolour	198	2067 TORX® HF Micro	35
899/4/1 S	315	967 TORX®	199	2067 TORX PLUS® IPR Micro	35
899/4/1 SB	315	967 XL TORX®	199	2069 Micro	37
899/8/1	315	967 XL HF TORX®	198	2069/6 Micro	41
899/14/1 SB	315	967/9 TX 1	196	2072 Micro	36
917 SPH	9	967/9 TX 1 SB	196	2090	383
917 SPH SB	9	967/9 TX HF 1	195	2090/17	383
917 SPHS	9	967/9 TX Multicolour HF 1	195	3160 i VDE	59
918 SPZ	9	967/9 TX XL 1	196	3160 i/7 Rack	59
918 SPZ SB	9	967/9 TX XL HF 1	195	3162 i VDE	59
921	218	967/9 TX XL Multicolour 1	195	3165 i VDE	59
932 A	8	967/9 TX XL Multicolour HF 1	195	3165 i/6 Rack	59
932 A SB	8	967/9 TX BO Multicolour 1	196	3167 i VDE TORX®	59
932 AS	8	967/9 TX BO Multicolour 1 SB	196	3167 i/7 Rack	60
932 S/6	11	977 TORX®	9	3334	6
932/6	11	977/6 TORX®	11	3334/3350/3355/6	8
932/918/6	11	1013 Kraftform Micro	37	3334/3355/6	7
950	193	1013 Kraftform Micro ESD	54	3334/6	7
950 BM	194	1060 i VDE	85	3335	6
950 L	193	1060 i/1062 i/6 VDE	85	3350	6
950 L HF	193	1060 i/1065 i/6 VDE	86	3355	7
950 PKL	192	1062 i PH VDE	85	3367	7
950 PKL BM	192	1065 i VDE	85	3368	7
950 PKL Imperial	192	1267 A TORX®	30	3800/4	291
950 PKLS	192	1267 A TORX PLUS®	31	3816 R	230
950 PKS	193	1267 B TORX®	31	3817 VDE Stainless	71
950 SPKL HF Multicolour	190	1267 B TORX PLUS®	31	3840/1 TS	293
950 SPKL Multicolour	191	1427	31	3840/4	296
950 SPKL Multicolour Imperial	191				

Article No. Index

3851/1 TS	260	6004 Joker VDE L	91	8004 B	119
3851/1 TS SB	261	6004 Joker VDE M	91	8004 C	138
3851/4	266	6004 Joker VDE S	91	8005	164
3855/1 TS	272	6004 Joker VDE XS	90	8006 C	135
3855/1 TS SB	272	6004 Joker VDE 4 Set 1	90	8006 SC 1	135
3855/4	276	6005 Joker Double	179	8007 B VDE	87
3867/1 TS TORX®	280	6005 Joker 4 Set 1	179	8008 A	165
3867/1 TS TORX® SB	280	7400	350, 351, 354, 355, 356, 357, 358, 359, 361	8009 Zyklop Pocket Set 1	152
3867/4 TORX® BO	288	7400 Imperial	350	8009 Zyklop Pocket Set 2	153
3868/4	302	7400 ESD	350, 355, 356, 360	8009 Zyklop Pocket Imperial Set 1	152
3869/4	305	7400 ESD Imperial	351	8009 Zyklop Pocket Set Imperial 2	154
3888/4/1 K	311	7400 ESD Halfmoon	351, 362, 357	8100 SA 2	96
3888/4/1 K SB	311	7400 VDE	79	8100 SA 4	97
3950 PKL	190	7440/41	352	8100 SA 6	95
3950 PKL Imperial	190	7440/41/42	352	8100 SA 7	99
3950 SPKL Multicolour	189	7443/12	353	8100 SA 8	100
3950 SPKL Multicolour HF	189	7443/61/9	353	8100 SA 9	95
3950 SPKL Multicolour Imperial	190	7445/46/47	352	8100 SA 10	99
3950/9 Hex-Plus Stainless 1	183	7761	380	8100 SA 11	101
3950/9 Hex-Plus Stainless 1 SB	183	7762	380	8100 SA 12 HF	101
3950/9 Hex-Plus Imperial Stainless 1	183	7763	380	8100 SA All-In	94
3950/9 Hex-Plus Multicolour HF		7763	380	8100 SA/SC 2	97
Stainless 1	182	7770	373	8100 SB 2	114
3950/9 Hex-Plus Multicolour Stainless 1	182	7771	374	8100 SB 4	114
3950/9 Hex-Plus Multicolour Imperial		7772 A	375	8100 SB 6	113
Stainless 1	184	7772 B	375	8100 SB 7	116
3967 SXL HF TORX® Multicolour	197	7772 C	375	8100 SB 8	118
3967/9 TX SXL Multicolour HF		7773 A	376	8100 SB 9	113
Stainless 1	195	7773 B	376	8100 SB 10	117
6000 Joker	168	7773 C	376	8100 SB 11	119
6000 Joker Imperial	168	7774/1	377	8100 SB All-in	112
6000 Joker 4 Set 1	169	7774/2	377	8100 SB HF 1	119
6000 Joker 4 Imperial Set 1	170	7774/3	377	8100 SB VDE 1	86
6000 Joker 8 Imperial Set 1	169	7775	378	8100 SC 2	133
6000 Joker 11 Set 1	169	7776	378	8100 SC 4	134
6000/6002 Joker 6 Set 1	169	7779/1	379	8100 SC 6	132
6001 Joker Switch	170	7779/2	379	8100 SC 7	136
6001 Joker Switch Imperial	171	7780	374	8100 SC 8	137
6001 Joker Switch 4 Set 1	172	7781	375	8100 SC 9	133
6001 Joker Switch 4 Imperial Set 1	172	7782 C	376	8100 SC 10	137
6001 Joker Switch 8 Imperial Set 1	172	7782 E	376	8100 SC 11	138
6001 Joker Switch 11 Set 1	171	7783 C	377	8740 A	108
6002 Joker Double	171	7783 E	377	8700 A FL	109
6003 Joker	173	7786	379	8740 A HF	108
6003 Joker Imperial	173	7790/1	379	8740 A HF 1	109
6003 Joker 4 Set 1	177	7790/2	379	8740 B	127
6003 Joker Set 4 Imperial Set 1	177	8000 A	98	8740 B HF	126
6003 Joker 5 Set 1	175	8000 A SB	98	8740 B HF 1	128
6003 Joker 5 Imperial Set 1	176	8000 B	115	8740 B HF Imperial 1	128
6003 Joker 8 Imperial Set 1	175	8000 B SB	116	8740 B VDE HF	88
6003 Joker 11 Set 1	174	8000 C	134	8740 C HF	148
6003 Joker 15 Set 1	174	8000 C SB	134	8740 C HF 1	149
6003 Joker 22 Set 1	174	8000 E	155	8740 C HF 2	149
6003 Joker Pedal	173	8001 A SB	164	8751 A	109
6004 Joker L	178	8002 C KOLOSS All Inclusive Set	154	8755 A	109
6004 Joker M	178	8002 C Set	155	8760 B VDE XZN	88
6004 Joker S	178	8003 A	100	8767 A	106
6004 Joker XL	178	8003 B	117	8767 A HF	106
6004 Joker XS	178	8003 C	137	8767 A HF 1	107
6004 Joker XXL	179	8004 A	101	8767 B	125
6004 Joker 4 Set 1	179			8767 B HF	124



8767 B HF 1	126	9604	48	Bicycle Set Torque 1	366
8767 B VDE HF	88	9605	48	Bit-Box 15 Impaktor PH	260
8767 C HF	146	9606	49	Bit-Box 15 Impaktor PZ	271
8767 C HF 1	147	9700	240	Bit-Box 15 Impaktor TX	279
8767 C HF 2	147	9710	241	Bit-Box 20 BTH PZ	273
8767 C HF 3	148	9711	242	Bit-Box 20 BTZ PH	262
8780 C	155	9712	242	Bit-Box 20 BTZ PZ	273
8781 C	155	9713	243	Bit-Box 20 PH	265
8782 C	155	9720	243	Bit-Box 20 PZ	275
8784 A1	111	9721	244	Bit-Box 20 TX	283
8784 B1	131	9722	244	Bit-Box 20 TX HF	282
8784 C2	151	9723	245	Bit-Box 20 V Robertson	300
8789 A	110	9730	245	Bit-Check 6 Impaktor 1	324
8789 B	130	9731	246	Bit-Check 6 Impaktor 1 SB	324
8789 C	151	9732	246	Bit-Check 6 PH Impaktor 1	324
8790 B VDE	88	9740	247	Bit-Check 6 PZ Impaktor 1	324
8790 C HF 1	143	9750	247	Bit-Check 6 PZ Universal 1	338
8790 C Impaktor	138	9780	248	Bit-Check 6 Stainless 1 SB	325
8790 C Impaktor Deep	140	9781	248	Bit-Check 6 TX Impaktor 1	324
8790 C Impaktor Deep Set 1	140	9782	249	Bit-Check 6 TX Universal 1	337
8790 C Wheel Impaktor	143	9783	249	Bit-Check 6 TX Universal 1 SB	337
8790 FA	165	Belt A 1	103	Bit-Check 6 Universal 1	336
8790 HMA	102	Belt A 2	108	Bit-Check 6 Universal 1 SB	336
8790 HMA Deep	105	Belt A 3	107	Bit-Check 6 Universal 2	337
8790 HMA HF	102	Belt A 4	103	Bit-Check 6 Universal 2 SB	337
8790 HMB	120	Belt A Deep 1	105	Bit-Check 6 V Universal 1	338
8790 HMB Deep	123	Belt A Imperial 1	104	Bit-Check 6 Wood TX HF 1	341
8790 HMB HF	120	Belt A, 8	111	Bit-Check 7 Diamond 1	329
8790 HMC	141	Belt A, 9	111	Bit-Check 7 Diamond 1 SB	330
8790 HMC Deep	144	Belt B 1	121	Bit-Check 7 Hex-Plus 1	336
8790 HMC HF	141	Belt B 2	127	Bit-Check 7 PZ Diamond 1	330
8794 A	111	Belt B 3	125	Bit-Check 7 PZ Universal 1	335
8794 B	131	Belt B 4	121	Bit-Check 7 TX BO Universal 1	336
8794 C	151	Belt B Deep 1	123	Bit-Check 7 TX Diamond 1	330
8794 LA	110	Belt B Imperial 1	129	Bit-Check 7 TX Universal 1	335
8794 LB	130	Belt B VDE 1	87	Bit-Check 7 TX Universal 1 SB	335
8794 LB VDE	89	Belt B VDE, 10	89	Bit-Check 7 Universal 1	334
8794 LC	150	Belt B, 8	131	Bit-Check 7 Universal 1 SB	335
8794 SA	110	Belt B, 9	131	Bit-Check 7 Universal 4	335
8794 SB	130	Belt C 1	142	Bit-Check 10 BiTorsion 1	328
8794 SB VDE	89	Belt C 2	149	Bit-Check 10 BiTorsion 3 SB	328
8794 SC	150	Belt C 3	146	Bit-Check 10 Drywall 1	347
8795 A	110	Belt C Deep 1	145	Bit-Check 10 Impaktor 1	322
8795 B	130	Belt C Impaktor 1	139	Bit-Check 10 Impaktor 1 SB	323
8795 C	151	Belt C Impaktor, 9	156	Bit-Check 10 Impaktor 2	323
8796 LA	109	Belt C, 6	155	Bit-Check 10 Impaktor 3	323
8796 LB	130	Bicycle Big Pack 1	30	Bit-Check 10 Impaktor 4	323
8796 LC	150	Bicycle Set 1	162	Bit-Check 10 PZ BiTorsion 2	328
8796 SA	110	Bicycle Set 2	212	Bit-Check 10 PZ Impaktor 1	323
8796 SB	130	Bicycle Set 3	163	Bit-Check 10 Stainless 1	325
8796 SC	150	Bicycle Set 4	188	Bit-Check 10 Stainless 1 SB	325
8797 C	136	Bicycle Set 5	223	Bit-Check 10 TX Impaktor 1	323
9100	229	Bicycle Set 6	48	Bit-Check 10 TX Universal 1	334
9200	316	Bicycle Set 7	115	Bit-Check 10 TX Universal 2	334
9500	31	Bicycle Set 8	129	Bit-Check 10 Universal 1	332
9506 SB	299	Bicycle Set 9	163	Bit-Check 10 Universal 2	333
9507 SB	299	Bicycle Set 10	175	Bit-Check 10 Universal 3	333
9514 ESD	58	Bicycle Set 11	223	Bit-Check 10 Universal 3 SB	333
9600	111	Bicycle Set 12	176	Bit-Check 10 Universal 4	333
9601	131	Bicycle Set 13	33	Bit-Check 10 Universal 5 SB	334
9602	156	Bicycle Set 15	33	Bit-Check 10 Zyklop Mini 1	161



Article No. Index

Bit-Check 10 Zyklus Mini BiTorsion 1	161	Kraftform 2go 100	65	Kraftform Kompakt Micro 11 ESD 1	56
Bit-Check 12 BiTorsion 1	327	Kraftform 2go 300	22	Kraftform Kompakt Micro 11 Universal 1	40
Bit-Check 12 BiTorsion 1 SB	327	Kraftform 300/7 Set 1	24	Kraftform Kompakt Micro 20 ESD 1	56
Bit-Check 12 Diamond 1	329	Kraftform 300/7 Set 2	25	Kraftform Kompakt Micro 21 ESD 1	55
Bit-Check 12 Diamond 1 SB	329	Kraftform 300/7 Set 3	25	Kraftform Kompakt Pistol RA	234
Bit-Check 12 Metal 1	342	Kraftform 300/7 Set 4	26	Kraftform Kompakt Pistol RA 4	234
Bit-Check 12 Metal 1 SB	342	Kraftform 900/7 Set 1	10	Kraftform Kompakt SH 1	228
Bit-Check 12 Wood 1	340	Kraftform 900/7 Set 2	10	Kraftform Kompakt SH 2	228
Bit-Check 12 Wood 1 SB	340	Kraftform 900/7 Set 3	10	Kraftform Kompakt Stubby 1	222
Bit-Check 12 Wood 2	340	Kraftform 3100 i/7 Set 1	60	Kraftform Kompakt Stubby ESD 1	57
Bit-Check 12 Wood 2 SB	340	Kraftform Big Pack 100 VDE	65	Kraftform Kompakt Stubby Magazine 1	221
Bit-Check 12 Wood TX HF 1	339	Kraftform Big Pack 300	21	Kraftform Kompakt Stubby Magazine 2	221
Bit-Check 30 BiTorsion 1	327	Kraftform Big Pack 900	10	Kraftform Kompakt Stubby Magazine 3	222
Bit-Check 30 Diamond 1	329	Kraftform Kompakt 10	203	Kraftform Kompakt Stubby Magazine 4	222
Bit-Check 30 Impaktor 1	322	Kraftform Kompakt 12	203	Kraftform Kompakt Stubby Magazine 5	222
Bit-Check 30 Impaktor 2	322	Kraftform Kompakt 20	205	Kraftform Kompakt Stubby Magazine RA 1	220
Bit-Check 30 Metal 1	341	Kraftform Kompakt 20 A	205	Kraftform Kompakt Stubby Magazine RA 2	221
Bit-Check 30 Stainless 1	325	Kraftform Kompakt 20 Tool Finder 1	204	Kraftform Kompakt Stubby Magazine RA 3	221
Bit-Check 30 TX Universal 1	332	Kraftform Kompakt 20 Tool Finder 2	205	Kraftform Kompakt Stubby Magazine RA 4	221
Bit-Check 30 Universal 1	332	Kraftform Kompakt 22	205	Kraftform Kompakt Turbo 1	202
Bit-Check 30 Wood 1	339	Kraftform Kompakt 25	206	Kraftform Kompakt Turbo Imperial 1	202
Bit-Check 30 Wood 2	339	Kraftform Kompakt 26	206	Kraftform Kompakt Turbo i 1	79
Bit-Check 30 Wood TX HF 1	338	Kraftform Kompakt 27 Imperial Set 1	207	Kraftform Kompakt Turbo i Imperial 1	80
Bit-Check 30 Zyklus Mini 1	157	Kraftform Kompakt 27 RA 1 SB	235	Kraftform Kompakt Vario RA	234
Bit-Check 30 Zyklus Mini 2	157	Kraftform Kompakt 27 RA 2 SB	235	Kraftform Kompakt VDE 7 extra slim 1	78
Bit-Safe 43 Universal 1	331	Kraftform Kompakt 27 Set 1	206	Kraftform Kompakt VDE 7 Imperial 1	78
Bit-Safe 61 BiTorsion 1	326	Kraftform Kompakt 27 Set 2	207	Kraftform Kompakt VDE 7 Universal 1	78
Bit-Safe 61 Universal 1	331	Kraftform Kompakt 28	208	Kraftform Kompakt VDE 7 Universal 2	79
Click-Torque A 5	364	Kraftform Kompakt 28 Imperial 1	207	Kraftform Kompakt VDE 15 Torque	
Click-Torque A 6	365	Kraftform Kompakt 28 SB	207	1,2-3,0 Nm extra slim 1	74
Click-Torque A 6 Set 1	365	Kraftform Kompakt 40	208	Kraftform Kompakt VDE 16 extra slim 1	77
Click-Torque B 1	366	Kraftform Kompakt 41	208	Kraftform Kompakt VDE 16 Torque	
Click-Torque B 2	367	Kraftform Kompakt 60	211	1,2-3,0 Nm extra slim 1	74
Click-Torque C 1	367	Kraftform Kompakt 60 ESD	55	Kraftform Kompakt VDE 16 Universal 1	78
Click-Torque C 2	367	Kraftform Kompakt 60 Imperial	211	Kraftform Kompakt VDE 17 extra slim 1	76
Click-Torque C 2 Push R/L	369	Kraftform Kompakt 60 KK	211	Kraftform Kompakt VDE 17 Universal 1	77
Click-Torque C 3	367	Kraftform Kompakt 60 RA	233	Kraftform Kompakt VDE 18 Imperial 1	75
Click-Torque C 3 Push R/L	370	Kraftform Kompakt 60 RA Imperial	233	Kraftform Kompakt VDE 18 Universal 1	75
Click-Torque C 3 Set 1	368	Kraftform Kompakt 60 Stainless	209	Kraftform Kompakt VDE 18 Universal 2	76
Click-Torque C 3 Set 2	368	Kraftform Kompakt 60 Stainless Imperial	210	Kraftform Kompakt VDE 60 i	80
Click-Torque C 4	369	Kraftform Kompakt 60 Take it easy	210	Kraftform Kompakt VDE 60 i SB	80
Click-Torque C 5	369	Kraftform Kompakt 60 Torque	209	Kraftform Kompakt VDE 60 iS	81
Click-Torque E 1	369	Kraftform Kompakt 62	212	Kraftform Kompakt VDE 60 iS SB	81
Click-Torque E 1 Push R/L	370	Kraftform Kompakt 70 Allround	213	Kraftform Kompakt VDE 62 i	81
Click-Torque X 1	370	Kraftform Kompakt 71 Security	213	Kraftform Kompakt VDE 62 iS	81
Click-Torque X 2	370	Kraftform Kompakt 96 VK 6,3	84	Kraftform Kompakt VDE 62 iS SB	81
Click-Torque X 3	371	Kraftform Kompakt 97 VK 8,1	84	Kraftform Kompakt VDE 62 i PH/S	82
Click-Torque X 4	371	Kraftform Kompakt 98 DK	84	Kraftform Kompakt VDE 62 iS PH/S	82
Click-Torque X 5	371	Kraftform Kompakt 99 FL	84	Kraftform Kompakt VDE 64 i	84
Click-Torque X 6	371	Kraftform Kompakt 100	214	Kraftform Kompakt VDE 64 i SB	84
Click-Torque XP 1	372	Kraftform Kompakt 400	215	Kraftform Kompakt VDE 65 i	81
Click-Torque XP 2	372	Kraftform Kompakt 400 RA Set 1	215	Kraftform Kompakt VDE 65 iS	82
Click-Torque XP 3	372	Kraftform Kompakt 400 RA Set 2	216	Kraftform Kompakt VDE 65 iS SB	82
Click-Torque XP 4	373	Kraftform Kompakt 400 RA Imperial Set 1	216	Kraftform Kompakt VDE 65 iS PZ/S	82
Hook and Loop Fastener Strip 1	257	Kraftform Kompakt 400 RA Imperial Set 2	217	Kraftform Kompakt VDE 65 iS PZ/S SB	83
Hook and Loop Fastener Strip 2	257	Kraftform Kompakt 900	217	Kraftform Kompakt VDE 67 i TORX®	83
Hook and Loop Fastener Strip 3	257	Kraftform Kompakt 900 Imperial Set 1	218	Kraftform Kompakt VDE 67 i TORX® SB	83
Kraftform 100 i/7 Set 1	69	Kraftform Kompakt F 1	229	Kraftform Kompakt VDE 67 iS TORX®	83
Kraftform 100 iS/7 Set 1	67	Kraftform Kompakt H 1	226	Kraftform Kompakt VDE 68 i	83
Kraftform 100 iS/7 Set 2	68	Kraftform Kompakt M 1	227	Kraftform Kompakt VDE 68 iS	83
Kraftform 100 iS/7 Set 3	68	Kraftform Kompakt Micro 11 Electronics 1	39		

Kraftform Kompakt VDE 3060 i SB	72	Wera 2go 7	254
Kraftform Kompakt VDE 3060 iS SB	72	Wera 2go E 1	256
Kraftform Kompakt VDE 3062 iS SB	72	Wera 2go H 1	255
Kraftform Kompakt VDE 3065 iS PZ SB	73	Wheel Impaktor C Set 1	144
Kraftform Kompakt VDE 3065 iS PZ/S SB	73	Zyklop Hybrid Set	135
Kraftform Kompakt VDE 3067 i TORX® SB	73		
Kraftform Kompakt VDE 3067 iS TORX® SB	73		
Kraftform Kompakt VDE Stainless 17 extra slim 1	70		
Kraftform Kompakt VDE Stainless 8 extra slim 1	71		
Kraftform Kompakt W 1	224		
Kraftform Kompakt W 2	225		
Kraftform Kompakt W Imperial 1	225		
Kraftform Kompakt Zyklop	98		
Kraftform Kompakt Zyklop Mini 2	158		
Kraftform Kompakt Zyklop MS1 Metal/Speed 1/4"	96		
Kraftform Micro 6 ESD	53		
Kraftform Micro 12 Electronics 1	39		
Kraftform Micro 12 Universal 1	38		
Kraftform Micro Big Pack 1	38		
Kraftform Micro ESD Big Pack 1	52		
Kraftform XXL	21		
Kraftform XXL 2	22		
Kraftform XXL 3	22		
Magnetic socket rail A 4	104		
Magnetic socket rail A Deep 1	106		
Magnetic socket rail A Imperial 1	104		
Magnetic socket rail B 4	122		
Magnetic socket rail B Deep 1	124		
Magnetic socket rail B Imperial 1	122		
Magnetic socket rail C 4	147		
Magnetic socket rail C Deep 1	145		
Magnetic socket rail C Impaktor 1	139		
Magnetic socket rail C Imperial 1	142		
Nut Extractor	103		
Patio construction set T 1	347		
Rack for Kraftform Micro screwdrivers	32		
Rack for Kraftform screwdrivers	32		
Safe-Torque A 1	381		
Safe-Torque A 1 Set 1	381		
Safe-Torque A 1 Imperial Set 1	382		
Safe-Torque A 2	381		
Safe-Torque A 2 Set 1	382		
Stubby Set 1	28		
Stubby Set 2	29		
Stubby Set 3	29		
Stubby Set TX 1	29		
Tool-Check 1 SB	160		
Tool-Check Automotive 1	160		
Tool-Check PLUS	159		
Tool-Check PLUS Imperial	159		
Wera 2go 1	252		
Wera 2go 2	252		
Wera 2go 2	256		
Wera 2go 2 XL	253		
Wera 2go 3	253		
Wera 2go 4	254		
Wera 2go 5	254		
Wera 2go 6	254		



Imprint

Subject to technical modifications!

Any reprinting – even only excerpts – shall only be permissible with the prior written consent of the company Wera Werkzeuge GmbH.

Edition: EN 1/2023

Trademarks used:

ACR	Phillips Screw Company
ASSY	Adolf Würth GmbH & Co. KG
AW	Adolf Würth GmbH & Co. KG
HIOS	Totsu, Katsuyuki
Microstix	OSG System Products Co. Ltd.
Phillips Recess	Phillips Screw Company
Pozidriv	registered trademark for Phillips Screw Company in Canada, Mexico and in the USA; for Trifast plc in the UK
PZ	registered trademark for Phillips Screw Company in Canada, Mexico and in the USA
PZ1, PZ2, PZ3	registered trademark in the USA for Phillips Screw Company
PUK	Josef Haunstetter Sägenfabrik KG
Robertson	British Robertson S.L.U.
SDS plus	Robert Bosch GmbH
SIT	Adolf Würth GmbH & Co. KG
SPAX	Altenloh, Brinck & Co. GmbH & Co. KG
T-STAR plus	Altenloh, Brinck & Co. GmbH & Co. KG
TORQ-SET	Phillips Screw Company
TORX	Acument Intellectual Properties, LLC, Troy, Mich., US
TORX PLUS	Acument Intellectual Properties, LLC, Troy, Mich., US
TRI-WING	Phillips Screw Company
BESSEY®	BESSEY Tool GmbH & Co. KG
“KIRSCHEN”®	Wilh. Schmitt & Comp. GmbH & Co. KG
KNIPEX®	KNIPEX-Werk C. Gustav Putsch KG
COBRA®	KNIPEX-Werk C. Gustav Putsch KG
Lyra®	Johann Froescheis Lyra-Bleistift-Fabrik GmbH & Co. KG
PFERD	August Rüggeberg GmbH & Co. KG
PICARD®	Picard GmbH
RENNSTEIG	Rennsteig Werkzeuge GmbH
Stabila®	STABILA Messgeräte Gustav Ullrich GmbH

We reserve the right to modify without prior notification any details stated in this catalogue regarding product features, versions and designs.
No liability for printing errors or mistakes shall be assumed.



Applifast.



251 Cree Crescent, Winnipeg, MB Canada R3J 3X4
Tel: 204 837 8361 • 1 800 563 1293
info@applifast.com



applifast.com