

Desoutter



Industrial Tools



MULTI CVIL II

Power Train approved

More Than Productivity



MULTICVIL II - Main Features

MULTICHANNEL SYSTEM

Drive up to 32 fixtured spindles
One CVIL Master +
x times CVIL Slave

Programming

Through CVIPC2000 (to Master only)

Cycles Phases management

- 31 different cycles
- Combines up to 20 phases in a fastening cycle

Data collection

- CVIPC2000
- CVI-NET collector data base

Fieldbuses

- By additional modules
- By Ethernet ports
- Flexible mapping

Isagraf, embedded PLC software to manage:

- Assembly station
- HMI

FIXTURED SPINDLES

- From 1 to 1900Nm
- EME straight
- EMEOF with Offset for close center distance application
- EMEL "L" shape reduces the height of the tool

Torque transducer

- High accuracy
- A10 class
- Digital communication between the tool and controller
- Memory chip with all characteristics of the tool: transducer sensitivity, gear ratio, maintenance info, etc...

One of best TS (torque/speed) ratio on the market

Resolver based long life brushless motor

50 or 60mm telescopic stroke



ONE CABLE

- **Motor power**
- **Digital connection of the transducer and memory device**
- **Up to 45 meters**
- **Design to be used in robot applications**

MultiPlus concept



FLEXIBILITY OF TIGHTENING PROCESS

EASY PROGRAMMING OF THE TIGHTENING SEQUENCE WITH FULL SYNCHRONIZATION

Run Down phase

Spindle 1-2-3-4-5-6-7-8-9-10

Final Speed phase

Spindle 1-2

Final Speed phase

Spindle 3-4-5-6

Final Speed phase

Spindle 7-8-9-10

Automatic Repair Action

Reverse all spindles and retry once

Jump to phase 2

End of the cycle

Reporting

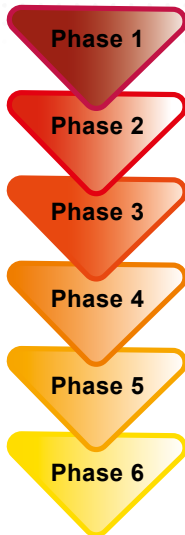

CVIPC

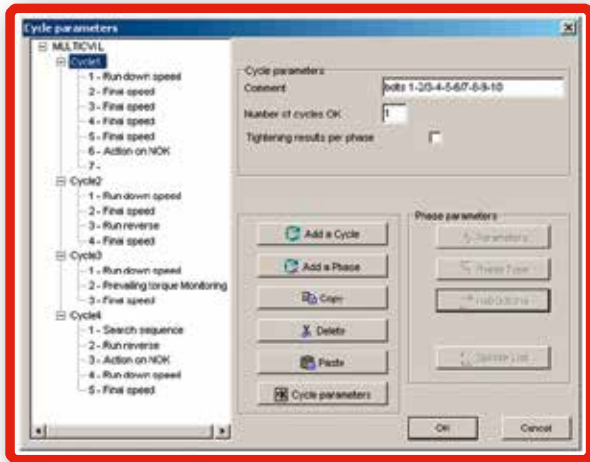

FUNCTION

MultiCVIL II

Number of channels 2 to 32

Number of cycles 31

Number of phases 20

Batch count 999

Bar code reading via RS232 port

Tightening results

Torque + Angle + Date

+ Time + Report up to 32 000

Number of curves (per channel) 10

Tightening strategies

Torque control + angle monitoring ✓

Angle control + torque monitoring ✓

T control + (Angle + torque rate) monitoring ✓

Angle control + (Torque + torque rate) monitoring ✓

Yield point strategy ✓

Stall torque ✓

Prevailing torque ✓

Current monitoring ✓

Reverse at Angle control ✓

Tightening connectivity

Input/Output 8/8

RS232 port OK

Ethernet RJ45 8 sockets

Fieldbuses Optional module

Embedded PLC software OK

IP54 Optional module

Emergency stop 2 channels

Multi display of tightening curves for joint analysis in real time

CVINET

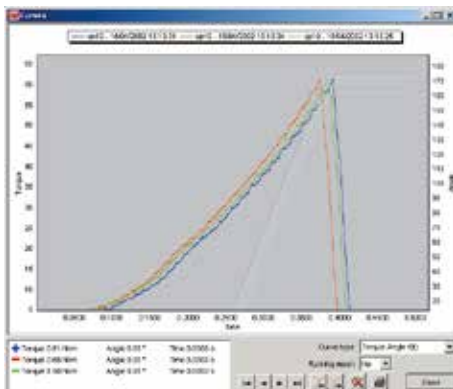

MULTICVIL II

Factory Networks

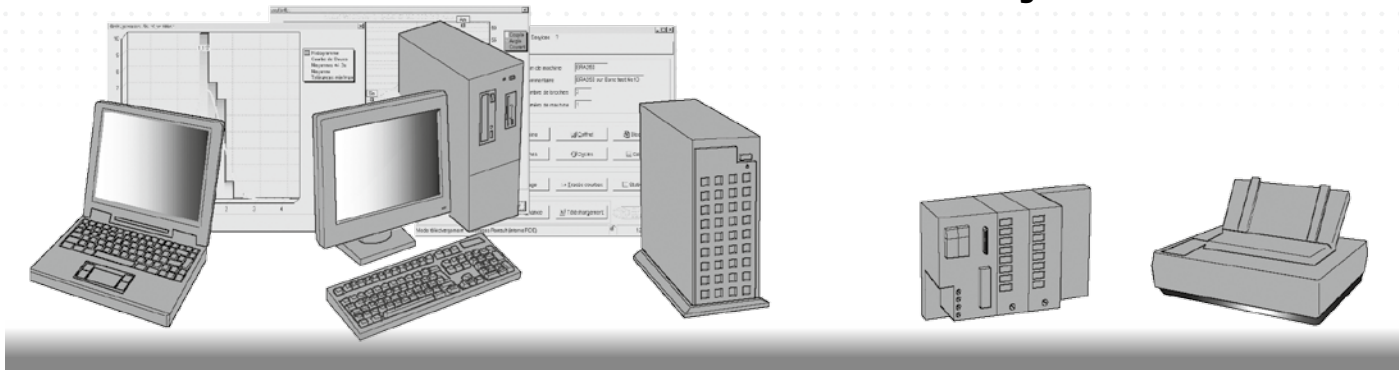

Only one IP address for the system

Master

Master

- Report I/O
- Ethernet TCP/IP
 - CVIPC2000 / CVINet
 - Customers protocols
 - Open protocol
- Integrate soft PLC to manage stations
- Option: IP54
- Can save up to 500 curves

Ethernet

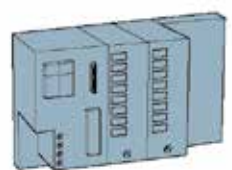
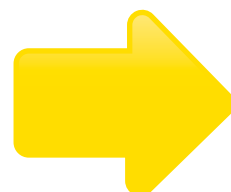

Fieldbuses connections

- Profinet, Profibus
- Devicenet, Ethernet IP
- CC link
- etc...
- Customers protocols



Remote HMI

EASY INTEGRATION IN A PRODUCTION LINE



Slave

up to 32 channels

- Screen keypad on each channel
 - easy to install
 - display final report + T&A
 - clear messages for maintenance

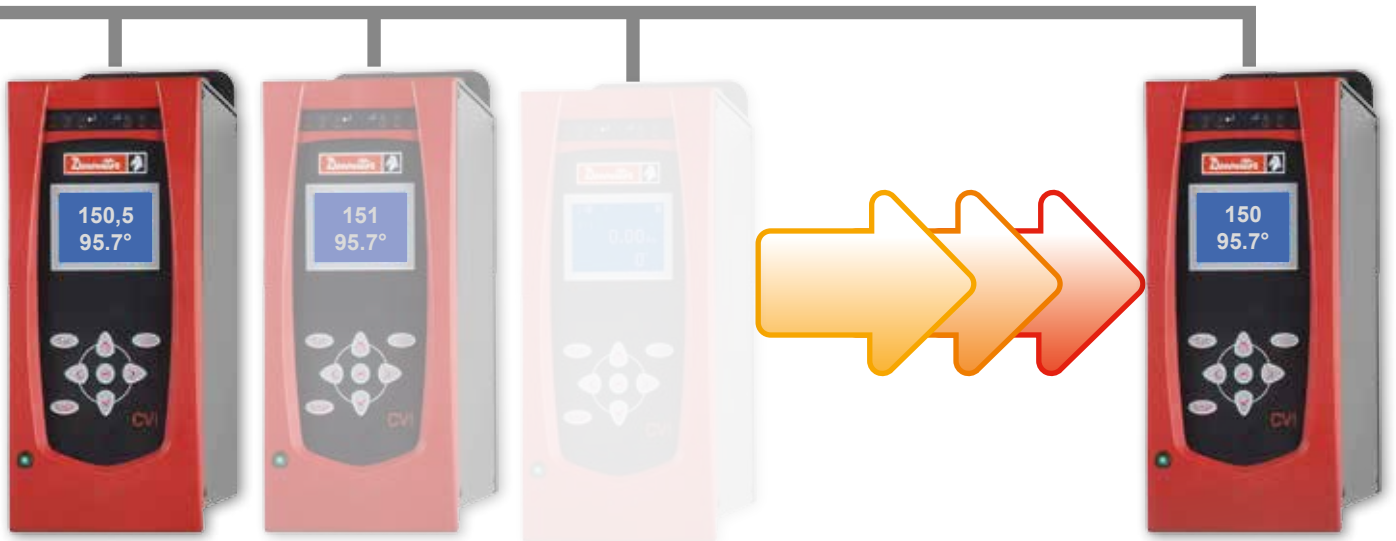

FIXTURED electric spindles

High durability of EME tools

- Long life gear boxes
- Brushless motor for a maintenance free
- High sensitivity torque transducer for a larger torque range

MODEL	PART NO.	TORQUE RANGE		ROTATIONAL SPEED rpm	MIN. CENTRE DISTANCE	
		Nm	ft.lb		mm	in.
EME35-10J	615 165 423 0	1-8	0.7-5.9	2067	43.2	1.7
EME35-20J	615 165 424 0	4-15	2.1-11	2067	43.2	1.7
EME38-10J	615 165 425 0	9-30	6.6-22	1287	43.2	1.7
EME38-20J	615 165 426 0	10-45	7.4-33	1092	43.2	1.7
EME51-10J	615 165 427 0	20-70	15-52	650	51.2	2.0
EME51-20J	615 165 428 0	30-135	22-99	403	51.2	2.0
EME60-10J	615 165 429 0	20-95	15-70	923	60.2	2.4
EME60-20J	615 165 430 0	50-175	37-129	507	60.2	2.4
EME60-30J	615 165 431 0	70-250	52-184	299	60.2	2.4
EME80-10J	615 165 432 0	80-300	59-221	286	80.2	3.2
EME80-20J	615 165 433 0	120-450	88-221	195	80.2	3.2
EME80-30J	615 165 434 0	180-650	133-479	130	80.2	3.2
EME80-40J	615 165 435 0	220-800	162-590	91	80.2	3.2
EME80-50J	615 165 436 0	220-1000	162-737	72	80.2	3.2
EME106-10J	615 165 437 0	430-1500	317-1105	52	106.2	4.2
EME106-20J	615 165 438 0	540-1900	398-1400	39	106.2	4.2



EMEL shape for close access

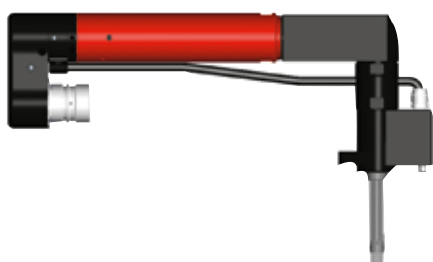

MODEL	PART NO.	TORQUE RANGE		ROTATIONAL SPEED rpm	MIN. CENTRE DISTANCE	
		Nm	ft.lb		mm	in.
EMEL38-20J	615 165 517 0	10-45	7.4-33.2	1092	43.2	1.7
EMEL51-20J	615 165 518 0	30-135	22-99.5	403	51.2	2.0
EMEL60-20J	615 165 519 0	50-175	37-129	481	60.2	2.4
EMEL60-30J	615 165 520 0	70-250	52-184	312	60.2	2.4
EMEL80-40J	615 165 521 0	220-800	162-590	91	80.2	3.2

EME Offset with torque transducer in line with the output shaft

Increase access by using smallest CC distances offered

MODEL	PART NO.	TORQUE RANGE		ROTATIONAL SPEED rpm	MIN. CENTRE DISTANCE	
		Nm	ft.lb		mm	in.
EME24-20 OF	615 165 512 0	4-20	2.9-15	1225	24	0.95
EME26-50 OF	615 165 513 0	7-50	5.2-40	985	26	1.02
EME30-80 OF	615 165 514 0	10-80	7.4-59	580	30	1.18
EME36-140 OF	615 165 515 0	19-140	14-103	375	36	1.42
EME40-180 OF	615 165 516 0	25-180	18-133	475	40	1.57
EME44-350 OF	615 165 602 0	80-350	59-258	217	45	1.77

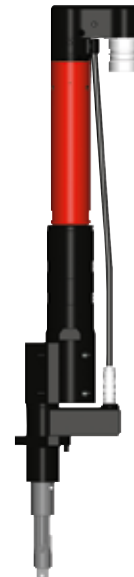

HOW TO ORDER

MODEL	PART NUMBER	CONSUMPTION (CURRENT)		MAINS SUPPLY	WIDTH		DIMENSIONS HEIGHT		DEPTH		WEIGHT	
		115V	230V		50/60 hertz	mm	in.	mm	in.	mm	in.	kg

MULTICVIL II controllers (Literature included)

CVIL II M (Master)	615 932 682 0	4A	2A	Single phase	130	5.1	278	10.9	291	11.5	5.9	13
CVIL II S (Slave)	615 932 683 0	4A	2A	Single phase	130	5.1	278	10.9	291	11.5	5.9	13
Multicombox	615 929 044 0											

CVIL II controller (Literature included)

CVIL II	615 932 680 0	4A	2A	Single phase	130	5.1	278	10.9	291	11.5	5.9	13
---------	---------------	----	----	--------------	-----	-----	-----	------	-----	------	-----	----

Optional Accessories

MODEL	PART NO.
PC cable length 2 m (78.7")	615 917 047 0
37 pin D-Sub female I/O adapter	615 919 003 0
Shelf support - Aluminium profile	615 397 403 5
IP54 option	615 932 684 0

"For any Desoutter software and licenses, please refer to our general catalogue"

Fieldbus Module

MODEL	PART NO.
Ethernet IP Module	615 927 594 0
Profi bus DP Module	615 927 595 0
Profi net Module	615 927 596 0
Devicenet Module	615 927 599 0
CC-Link Module	615 927 598 0
MODBUS TCP Slave	615 927 615 0

Power cord

to be ordered with the controller

PLUG	DESCRIPTION	PART NO.
A	European	615 917 201 0
B	UK	615 917 202 0
C	Chinese	615 917 206 0



Cable for EME tools - Multi CVIL II & CVIL II

CABLE LENGTH	5m (16.4ft)	10m (32.8ft)	15m (49.1ft)	20m (65.6ft)	25m (82ft)	30m (98.4ft)
Tool cable	615 917 541 0	615 917 542 0	615 917 543 0			
Extension cable	615 917 083 0	615 917 084 0	615 917 085 0	615 917 086 0	615 917 087 0	615 917 088 0

Kit version

One CVIL-Master

n.CVIL-Slaves

Software CVIPC 2000
+ Power cord

Multicombox

Contact your Desoutter representative for assistance

Also available:
Specially designed a frame to secure controllers and ensure safe and tidy wiring

Turn Key Solution

One CVIL-Master

n.CVIL-Slaves

Software CVIPC 2000
+ Network cables & Power cord

One power box supply with
E Stop - Ethernet switches
Multicombox - Circuit breakers

Powerbox depending on power supply

MULTIPLUS: standard solutions adapted to your needs



The concept is easy - 4S

- **S** Streamlined processes for quote, design and build
- **S** Standardized library of designs
- **S** Simple to change and adapt
- **S** Shipped 5 weeks from order

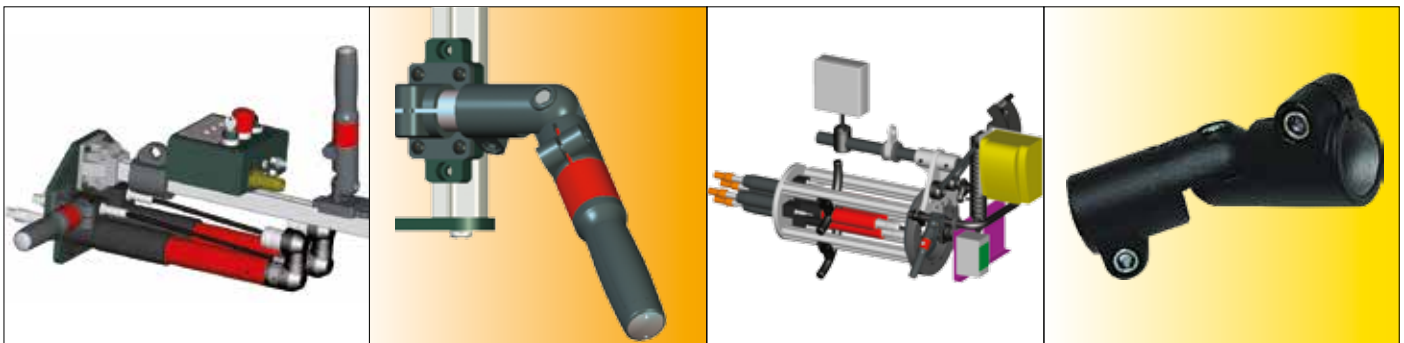

The HMI combines several functions

- Display Final Torque and Angle results
- Display the tightening report «accept» or «reject»



HMI

- In case of «reject» several options are offered to the operator:
 - reverse
 - reverse and rework the joint
 - cancel the complete operation
- Guarantee that all bolts have been tightened at the right Torque and Angle
- Associated with the SFP software, much more advanced functions are available
 - provide a solution to guide the operator to follow a route or sequence in the assembly process
 - positioning system X-Y-Z (with overview or detailed pictures)
 - selection of different jobs through a barcode

WE PROVIDE EFFICIENT SOLUTIONS

Download all 3D models of tools

• Via desouttertools.com/cadfiles

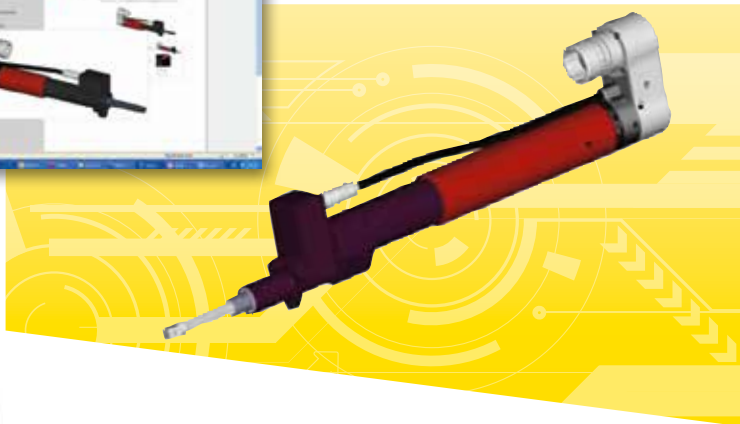

• Select your image format
TIF, CATPart, DXF, IGS, PRT, STP

Download documentation

Via desouttertools.com/cadfiles

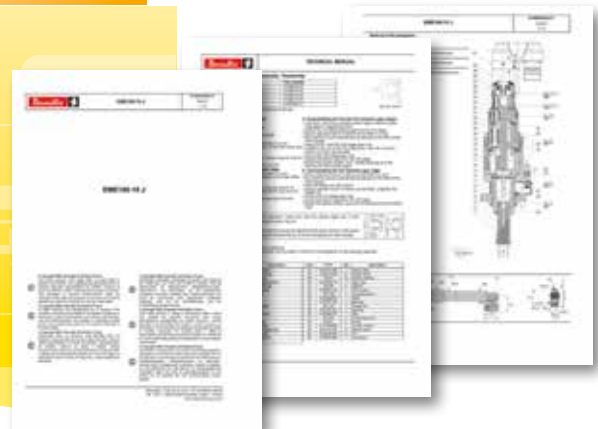

CVIL II - A lean controller

FLEXIBLE INTEGRATION

- Small controller with LCD/LED display
- Fully controlled by the production line process
- From a simple connection 7 inputs/8 outputs/RS232C up to a Fieldbus communication

FULL TRACEABILITY

- CVI NET
- CVIPC
- Ethernet network
- Store results and graphs

RAPID AND EASY TO START

- On board tool memory and digital communication eliminates risk of connecting wrong tool to the controller
- Simply connect the tool and the controller will read all tool features in the tool memory
- Intuitive programming from the keypad / display
Enter the torque value and the controller will calculate and optimize all parameters
- Extended programming capabilities with CVIPC 2000

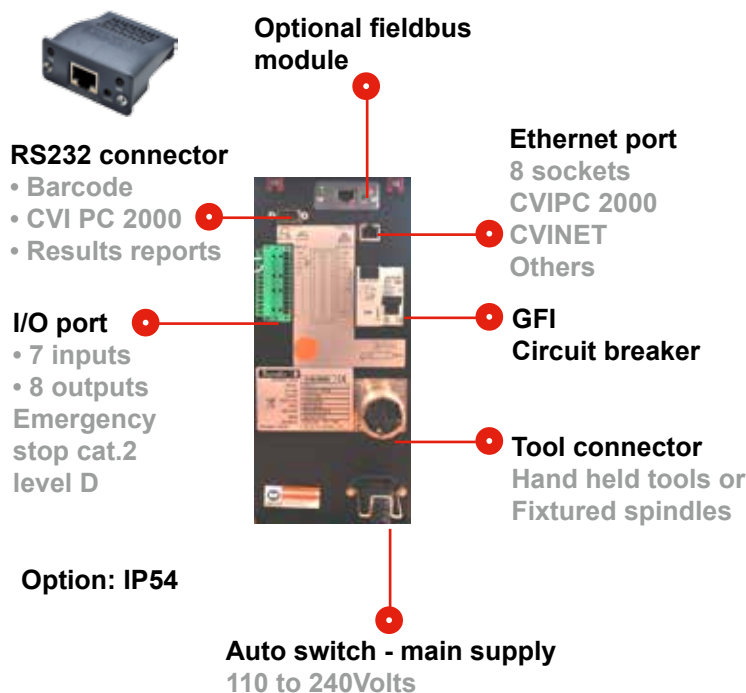
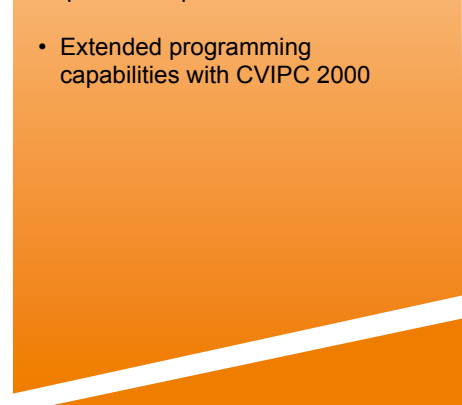

MAIN FUNCTIONS

Number of channels	1
Number of cycles	50
Number of phases	15
Batch count	999
Bar code reading via RS232 port	

Tightening results

Batch count + Angle + Date + Time + Report + VIN number	up to 10 000
Number of curves (flexibility with OK and NOK)	10

Tightening strategies

Torque control + angle monitoring	✓
Angle control + torque monitoring	✓
Stall torque	✓
Prevailing torque, self tapping	✓
Seating detection	✓
Current monitoring	✓
Reverse at angle control	✓

FOR YOUR SAFETY CRITICAL APPLICATIONS

- Brushless motor + resolver = maintenance free
- Long lasting gears + spiral cut angle heads = optimum accuracy and repeatability
- Wide torque range per tool = fewer tools needed to cover multi torque applications



HANDHELD TOOLS

ERAL
Torque range: 2-480Nm

OFFSET CROWFOOT & OFFSET TUBE NUT

ERDL
Torque range: 0.5-250Nm

FLUSH SOCKET

ERP
Torque range: 0.3-40Nm

HOLD & DRIVE

ERF
Torque range: 0.3-40Nm



FIXTURED SPINDLES

EME
Torque range: 1-1900Nm

EMEL
Torque range: 10-800Nm

EME-OFFSET
Torque range: 4-350Nm

More Than Productivity

Applifast.



251 Cree Crescent, Winnipeg, MB Canada R3J 3X4
Tel: 204 837 8361 • 1 800 563 1293
info@applifast.com



applifast.com