

Cleco®

Pneumatic Assembly Tools



Table of Contents



Screwdrivers	2-14
Introduction	2-5
Clutch Selection Guide	3
Inline – Clutch	6-7
Pistol – Clutch	8-10
Pistol – Stall	11
Accessories	12-13
Nomenclature	14
Angle Nutrunners	15-23
Introduction	15-17
Angle Nutrunners – Clutch	18-21
Angle Nutrunners – Stall	22-23
Reaction Bar & Swingbar Nutrunners	24-27
Introduction	24-25
Inline & Pistol Tools	26-27
Specialty Tools	28-35
Flush Socket Nutrunners	28-29
Crowfoot Nutrunners	30-31
Hold & Drive Nutrunners	32-33
Tube Nut Wrenches	34-35
Nutrunner Accessories	36-39
General	36
Torque Verifier	37-39
Ratchet Wrenches	40-47
Introduction	40-41
Tools & Accessories	42-47
Pulse Nutrunners	48-52
Introduction	48-49
Tools & Accessories	50-53
Impact Wrenches	54-57
Introduction	54-55
Impact Wrenches	56-57
General Accessories	58-67
Introduction	58
Balancers	59
Arms & Accessories	60-62
Apex Fastener Tools	64-67
General Information	68-76
Conversion Tables	68
Sales & Service Centers	70
Warranty, Lubrication, Safety	72
Model Number Index	74-76

Screwdrivers

Cleco®

A tradition of quality is built into every screwdriver.

Cleco screwdrivers have long been recognized as the assembly tool standard against which all other brands are measured. With over 100 years of precision manufacturing experience built into each tool, Cleco screwdrivers provide users the ultimate in light and medium duty assembly tool performance.

Cleco's long standing tradition of service to the customer has led us to develop an extensive line of screwdrivers with configurations to suit a broad range of applications. Options including multiple reversing methods, different clutch styles, numerous handle alternatives, and a wide variety of accessories provide the building blocks for tool configurations designed to meet our customers' unique assembly application requirements.

The Cleco 2 series of inline Clecomatic screwdrivers offer dependable repetitive torque accuracy from .5 to 8 in.-lbs., ideal for miniature assemblies often found in extra light-duty electronics assembly using #0 to #5 screws.

In the light to medium duty assembly tool market, the ergonomically designed Cleco 19 series screwdrivers, with a torque range of 0.6 to 130 in.-lbs., are the ultimate tools for an infinite range of applications including electronics, automotive, aerospace, appliance and general assembly.

With a torque range of 15 to 180 in.-lbs (1.7 to

60 MONTH WARRANTY

Cleco® 19 & 8 Series Clecomatic® Screwdrivers

Apex Tool Group warrants the 19 and 8 series Clecomatic screwdrivers and parts to be free from defects in workmanship and material of the life of the tool. The clutch assemblies are warranted for SIXTY MONTHS against failure or wear causing malfunction.

Apex Tool Group's obligation under this warranty is to repair or replace, without charge to the original purchaser, any part which does not meet the warranty outlined above during the active commercial production of this tool. This tool is to be returned to the factory with carrying charges prepaid.

This warranty shall not apply to any product that has been fixture mounted or subjected to misuse, negligence or accident; or in which parts not made or supplied by Apex Tool Group shall have been used; or which shall have been altered or repaired by other than Apex Tool Group personnel in a manner which in the determination of Apex Tool Group shall have affected its operation.

THIS WARRANTY CONSTITUTES THE ENTIRE OBLIGATION OF THE COMPANY RELATING TO THE SALE AND USE OF SUCH PRODUCT AND ITS MAXIMUM LIABILITY IS LIMITED TO THE PURCHASE PRICE OF SUCH PRODUCT. IN NO EVENT SHALL THE COMPANY BE LIABLE FOR CONSEQUENTIAL, INDIRECT, INCIDENTAL OR SPECIAL DAMAGES OF ANY NATURE ARISING FROM THE SALE OF USE OF SUCH PRODUCT.

20Nm), the 8 & 88 series Cleco screwdrivers cover the gamut of medium duty assembly applications ranging from lawn and garden equipment to small recreational vehicles, and even aerospace.

Capable of running down fasteners as large as 5/16 (M6), the Cleco 35 series screwdrivers are the true workhorses of the medium to heavy-duty screw assembly market.



Clutch Selection Guide



Choose the right tool to match your application.



New Clecomatic® Clutch

Clecomatic® Clutch

When tightening a fastener, torque is transmitted through the Clecomatic clutch to the fastener until the clutch can no longer transmit the increasing torque. The clutch then “slips”, which allows an internal mechanism to seal off air to the air motor, shutting off the tool at the user-adjusted preset torque level. This type of torque control allows maximum RPM from the tool for increased productivity. Since the tool doesn’t dwell on the fastener as with a stall tool, tool wear and fatigue to the operator is reduced. The life of a Clecomatic tool is up to five times longer than that of a lever-operated, ratcheting clutch screwdriver.

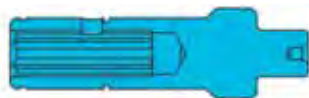

Stall Type

Stall Type

The stall tool doesn’t use a clutch but rather the output spindle is coupled to the last stage of gearing. Torque output from a stall tool may be controlled within fairly reasonable limits with an air pressure regulator. Stall type tools are also trigger activated.

CLUTCH SELECTION GUIDE FOR COMMON FASTENING APPLICATIONS

CLUTCH TYPE	APPLICATION	STANDARD BOLT & NUT	SHEET METAL SCREW	STANDARD BOLT & NUT	SELF-TAPPING SCREW	SELF-LOCKING NUT
Clecomatic®		EXCELLENT	EXCELLENT	EXCELLENT	EXCELLENT Where seating torque exceeds tapping torque	EXCELLENT
Stall Drive		FAIR Under certain conditions	GOOD Under certain conditions	FAIR Under certain conditions	FAIR Under certain conditions	FAIR

Cleco 19 Series

Accuracy. Durability.

Built by your expertise and our experience

Your productivity is our greatest influence. The development of the Cleco 19 Series is driven by experts—you, the very people that have depended on Cleco assembly products for over a century.

Whatever your application, consider it done

We set out to design the most accurate, longest-lasting, most user-friendly screwdriver family on the market. Our widespread configurations and applications ensure that you will find the ideal screwdriver or nutrunner.



Designed for the most demanding jobs

Continuously improving end-product quality is evermore critical. The Cleco 19 Series is engineered for the most demanding fastening applications where accuracy, repeatability, and durability are held to the strictest standard. Imagine what the Cleco 19 Series can do for you.

Adding value to your business

With a new powertrain design, the Cleco 19 Series tools have reached a new milestone in performance and accuracy. This, combined with legendary Cleco reliability, means you will have the sustained power to get it right the first time, every time.

Designed with the operator in mind

A soft-touch grip is integrated into the new handle design to provide superior protection from temperature, chemicals, vibration, and slip. What's more, Cleco 19 Series pistol tools offer two interchangeable handle sizes to bring comfort to a wider array of operators. These features, plus reduced weight and a balanced design, will raise productivity, tool flexibility, and reduce maintenance costs.



Quality. Productivity.

Completely re-engineered **Clecomatic®** clutch delivers **best-in-class accuracy**, exceeding a Cm of 2.0 with a tolerance of $\pm 10\%$.

New design and advanced materials yield up to **19% weight reduction** based on configuration, at no loss of balance or durability.

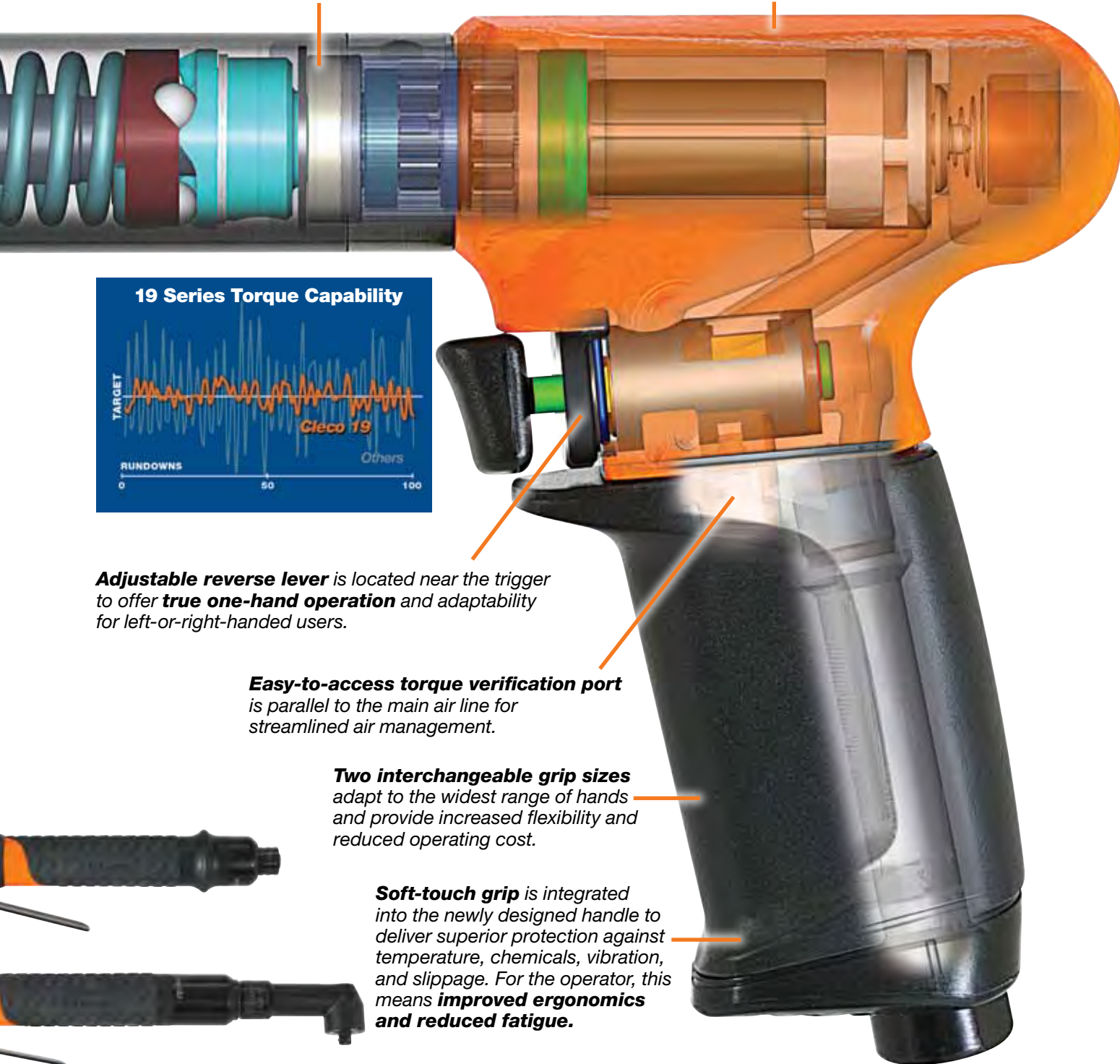

19 Series Torque Capability

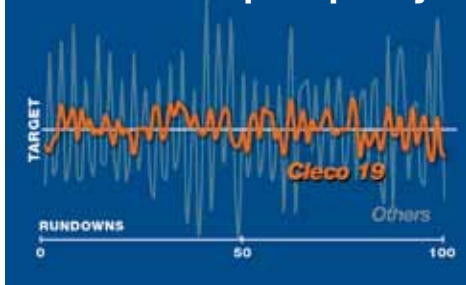

Adjustable reverse lever is located near the trigger to offer **true one-hand operation** and adaptability for left-or-right-handed users.

Easy-to-access torque verification port is parallel to the main air line for streamlined air management.

Two interchangeable grip sizes adapt to the widest range of hands and provide increased flexibility and reduced operating cost.

Soft-touch grip is integrated into the newly designed handle to deliver superior protection against temperature, chemicals, vibration, and slippage. For the operator, this means **improved ergonomics and reduced fatigue**.

Inline Screwdrivers

2, 19, 8, 88, 35 Series Clecomatic Clutch

Cleco®

2 Series

Torque Range: .06 - .9 Nm 0.5 - 8 In. Lbs.

- Push-to-start
- Push button reverse
- External torque adjustment
- 1/4" quick change chuck

19 Series

Torque Range: 0.6 - 14.7 Nm 5 - 130 In. Lbs.

- Push-to-start and Push & Lever start
- External torque adjustment
- Bit & Finder & 1/4" quick change chuck

8 Series

Torque Range: 1.7 - 8.5 Nm 15.0 - 75 In. Lbs.

- Push button reverse and non-reversible
- Push-to-start and Push & Lever start
- Bit & Finder and Quick change

88 Series

Torque Range: 1.7 - 19 Nm 15 - 170 In. Lbs.

- Push button reverse and non-reversible
- Push-to-start and Push & Lever start
- Quick change & 3/8" square drive

35 Series

Torque Range: 1.7 - 20 Nm 15 - 180 In. Lbs.

- Quick change and square drive
- Short stroke button reverse
- External torque adjustment (Quick change models)



Model Number		Torque Range				Free Speed	Length*		Weight		Air Consumption			
Bit & Finder*	1/4" Quick Change	Tool Range		With Std. Spring			in.	mm	lbs.	kg	Air Inlet NPT	Min. Hose I.D.	SCFM	
		in.-lbs.	Nm	in.-lbs.	Nm	RPM								
Push-to-Start - Push Button Reverse														
	2RSA-10B			0.5 - 8	.06 - 0.9	1000	7.6	194	0.5	0.20	1/8"	3/16"	6	
	2RSA-10SB**			0.5 - 8	.06 - 0.9	1000	6.4	162	0.5	0.20	1/8"	3/16"	6	
	19BPA02Q	5 - 19	0.6 - 2.1	5 - 19	0.6 - 2.1	2300	9.1	230	1.4	0.63	1/8"	3/16"	11	
	19BPA03Q	5 - 26	0.6 - 2.9	5 - 19	0.6 - 2.1	1600	9.3	235	1.4	0.64	1/8"	3/16"	11	
	19BPA04Q	10 - 40	1.1 - 4.5	10 - 38	1.1 - 4.3	920	9.1	230	1.3	0.61	1/8"	3/16"	11	
	19BPA05Q	10 - 45	1.1 - 5.1	10 - 38	1.1 - 4.3	560	9.5	240	1.5	0.67	1/8"	3/16"	11	
	19BPA06Q	10 - 45	1.1 - 5.1	10 - 38	1.1 - 4.3	220	9.5	240	1.5	0.68	1/8"	3/16"	11	
Push-to-Start - Collar Reverse														
	19SPA02B	19SPA02Q	5 - 19	0.6 - 2.1	5 - 19	0.6 - 2.1	2800	9.1	230	1.4	0.63	1/8"	3/16"	11
	19SPA03B	19SPA03Q	5 - 26	0.6 - 2.9	5 - 19	0.6 - 2.1	1900	9.3	235	1.4	0.64	1/8"	3/16"	11
	19SPA04B	19SPA04Q	10 - 40	1.1 - 4.5	10 - 38	1.1 - 4.3	1100	9.1	230	1.3	0.61	1/8"	3/16"	11
	19SPA05B	19SPA05Q	10 - 45	1.1 - 5.1	10 - 38	1.1 - 4.3	660	9.5	240	1.5	0.67	1/8"	3/16"	11
	19SPA06B	19SPA06Q	10 - 45	1.1 - 5.1	10 - 38	1.1 - 4.3	260	9.5	240	1.5	0.68	1/8"	3/16"	11
Lever Push-to-Start - Collar Reverse														
	19SCA02B	19SCA02Q	5 - 19	0.6 - 2.1	5 - 19	0.6 - 2.1	2800	9.8	249	1.5	0.69	1/8"	3/16"	11
	19SCA03B	19SCA03Q	5 - 26	0.6 - 2.9	5 - 19	0.6 - 2.1	1900	10.0	254	1.5	0.70	1/8"	3/16"	11
	19SCA04B	19SCA04Q	10 - 40	1.1 - 4.5	10 - 38	1.1 - 4.3	1100	9.8	249	1.5	0.66	1/8"	3/16"	11
	19SCA05B	19SCA05Q	10 - 45	1.1 - 5.1	10 - 38	1.1 - 4.3	660	10.2	259	1.6	0.73	1/8"	3/16"	11
	19SCA06B	19SCA06Q	10 - 45	1.1 - 5.1	10 - 38	1.1 - 4.3	260	10.2	259	1.6	0.74	1/8"	3/16"	11

*Add .63" (16mm) for bit & finder models

** Short housing

General:

90 psi (620kPa) required for maximum rated torque.

Standard Equipment:

Operating instructions & service manual.
Suspension bail.

All torque springs required to meet indicated torque.
Lever Push-to-Start models include kit to convert to lever only. (301409)

Optional Equipment:

Additional accessories: Pages 12-13
Bits & finders: Page 12

Non-Reverse Kit: 207030
Torque Signal Kit: 301106 (lever only)
Overhose: 207019

Model Number			Torque Range		Free Speed	Length*		Weight		Air Consumption			
Bit & Finder	1/4" Hex Quick Change	3/8" Square Drive	in.-lbs.	Nm		in.	mm	lbs.	kg	Air Inlet NPT	Min. Hose I.D.	SCFM	
Push-to-Start - Push Button Reverse													
	8RSA-10	8RSA-10BQ	15 - 65	1.7 - 7.3	800	9.6	260	2.4	1.1	1/4"	1/4"	19	
		8RSA-7BQ	15 - 75	1.7 - 8.5	550	9.6	260	2.4	1.1	1/4"	1/4"	19	
		8RSA-5BQ	15 - 75	1.7 - 8.5	400	9.6	260	2.4	1.1	1/4"	1/4"	19	
		88RSA-7CQ	88RSA-7C-3	15 - 95	1.7 - 10	550	9.5	241	2.6	1.2	1/4"	1/4"	19
		88RSA-5CQ	88RSA-5C-3	15 - 160	1.7 - 18	400	9.5	241	2.6	1.2	1/4"	1/4"	19
Push-to-Start - Non-Reversible													
		88SA-7CQ		15 - 100	1.7 - 11	650	9.1	232	2.5	1.1	1/4"	1/4"	19
		88SA-5CQ	88SA-5C-3	15 - 170	1.7 - 19	500	9.1	232	2.5	1.1	1/4"	1/4"	19
Push and Lever Start - Push Button Reverse													
		8RSAL-10BQ		15 - 60	1.7 - 6.8	800	11.3	302	2.9	1.3	1/4"	1/4"	19
		88RSAL-5CQ	88RSAL-5C-3	15 - 160	1.7 - 18	400	11.1	282	3.1	1.4	1/4"	1/4"	19
Inline - Push-to-Start - Push Button Reverse													
		35RSA-20Q		15 - 60	1.7 - 7	1250	9.6	244	2.5	1.1	1/4"	5/16"	24
		35RSA-10Q	35RSA-10-3	15 - 110	1.7 - 12	620	10.4	264	2.8	1.2	1/4"	5/16"	24
		35RSA-7Q		15 - 160	1.7 - 18	410	10.4	264	2.8	1.2	1/4"	5/16"	24
		35RSA-5Q	35RSA-5-3	15 - 180	1.7 - 20	300	10.4	264	2.8	1.2	1/4"	5/16"	24

*Add .63" (16mm) for bit & finder models

General:

90 psi (620kPa) required for maximum rated torque.

Length and weight of finder type tools includes standard length bit & finder.

Weight does not include dead handle.

Standard Equipment:

Operating instructions & service manual
Suspension bail

Dead handle on models above 100 in.lbs. torque cap.
All torque springs required to meet indicated torque

Standard Equipment if Specified:

One bit, finder, and finder spring (bit & finder models)
Grip Sleeve (202346; Push-to-Start models only)
Dead handle (861006)

Optional Equipment:

Additional accessories: Pages 12-13

Bits & finders: Page 12

Torque Springs: Page 13

Pistol Grip Screwdrivers

19 Series Clecomatic Clutch

Cleco®

19 Series

Torque Range: 0.6-14.7 Nm 5.0-130 In. Lbs.

- Class-leading accuracy and repeatability
- Adjustable reverse lever for true one-hand – left-handed or right-handed – operation
- External torque adjustment
- 1/4" hex quick change drive
- "P" and "T" style handles
- 2 interchangeable soft-touch grip sizes
- Streamlined torque signal ports
- Trigger and Push & Trigger start



NEW!



The "T" handle is best for applications that are pre-threaded and the grip on the tool is required to simply guide the tool as the fastener is being tightened.

19TTA02Q
"T" Handle

The renowned Clecomatic® clutch is re-engineered to provide class-leading accuracy/repeatability and improve the already legendary durability.

NEW!



19PTA05Q
"P" Handle

The "P" handle is best suited for thread cutting fasteners where force must be exerted against the ergonomically shaped "P" handle during the process.



Model Number	Torque Range				Free Speed	Length		Weight		Air Consumption		
	Tool Range		With Std. Spring			in.	mm	lbs.	kg	Air Inlet NPT	Min. Hose I.D.	SCFM
1/4" Quick Change	in.-lbs.	Nm	in.-lbs.	Nm	RPM							
Push and Trigger Start - T Handle - Clecomatic Clutch												
19TCA02Q	5 - 19	0.6 - 2.1	5 - 19	0.6 - 2.1	2800	8.0	202	1.44	0.7	1/4"	3/8"	11
19TCA03Q	5 - 26	0.6 - 2.9	5 - 19	0.6 - 2.1	1900	8.2	207	1.54	0.7	1/4"	3/8"	11
19TCA04Q	10 - 40	1.1 - 4.5	10 - 38	1.1 - 4.3	1100	8.0	202	1.54	0.7	1/4"	3/8"	11
19TCA05Q	10 - 45	1.1 - 5.1	10 - 38	1.1 - 4.3	660	8.4	212	1.54	0.7	1/4"	3/8"	11
19TCA06Q	10 - 45	1.1 - 5.1	10 - 38	1.1 - 4.3	260	8.4	212	1.54	0.7	1/4"	3/8"	11
19TCA07Q	15 - 60	1.7 - 6.8	24 - 60	2.7 - 6.8	660	8.4	212	1.54	0.7	1/4"	3/8"	11
19TCA09Q	15 - 79	1.7 - 8.9	24 - 60	2.7 - 8.9	470	9.3	235	1.73	0.8	1/4"	3/8"	11
Trigger Start - T Handle - Clecomatic Clutch												
19TTA02Q	5 - 19	0.6 - 2.1	5 - 19	0.6 - 2.1	2800	7.9	199	1.44	0.7	1/4"	3/8"	11
19TTA03Q	5 - 26	0.6 - 2.9	5 - 19	0.6 - 2.1	1900	8.1	204	1.54	0.7	1/4"	3/8"	11
19TTA04Q	10 - 40	1.1 - 4.5	10 - 38	1.1 - 4.3	1100	7.9	199	1.54	0.7	1/4"	3/8"	11
19TTA05Q	10 - 45	1.1 - 5.1	10 - 38	1.1 - 4.3	660	8.3	210	1.54	0.7	1/4"	3/8"	11
19TTA06Q	10 - 45	1.1 - 5.1	10 - 38	1.1 - 4.3	260	8.3	210	1.54	0.7	1/4"	3/8"	11
19TTA07Q	15 - 60	1.7 - 6.8	24 - 60	2.7 - 6.8	660	8.3	210	1.54	0.7	1/4"	3/8"	11
19TTA09Q	15 - 79	1.7 - 8.9	24 - 79	2.7 - 8.9	470	9.3	235	1.73	0.8	1/4"	3/8"	11
19TTA15Q	45 - 130	5.1 - 14.7	45 - 130	5.1 - 14.7	260	9.6	243	1.94	0.9	1/4"	3/8"	11

General: Tool performance rated at 90 psi (620kPa) air pressure. Dead handle on models above 100 in.-lbs. torque cap. All torque springs required to meet indicated torque specification. Torque Springs: Page 13 Torque Signal Kit: 302021PT (Trigger w/Clecomatic clutch only) Overhose: 207107 Push-only Conversion Kit: 301121

Standard Equipment: Operating instructions & service manual Suspension bail

Optional Equipment: Additional accessories: Pages 12-13

Model Number	Torque Range				Free Speed	Length		Weight		Air Consumption		
	Tool Range		With Std. Spring			in.	mm	lbs.	kg	Air Inlet NPT	Min. Hose I.D.	SCFM
1/4" Quick Change	in.-lbs.	Nm	in.-lbs.	Nm	RPM							
Push and Trigger Start - P Handle - Clecomatic Clutch												
19PCA02Q	5 - 19	0.6 - 2.1	5 - 19	0.6 - 2.1	2800	8.1	206	1.41	0.6	1/4"	3/8"	11
19PCA03Q	5 - 26	0.6 - 2.9	5 - 19	0.6 - 2.1	1900	8.3	211	1.51	0.7	1/4"	3/8"	11
19PCA04Q	10 - 40	1.1 - 4.5	10 - 38	1.1 - 4.3	1100	8.1	206	1.41	0.6	1/4"	3/8"	11
19PCA05Q	10 - 45	1.1 - 5.1	10 - 38	1.1 - 4.3	660	8.5	216	1.51	0.7	1/4"	3/8"	11
19PCA06Q	10 - 45	1.1 - 5.1	10 - 38	1.1 - 4.3	260	8.5	216	1.51	0.7	1/4"	3/8"	11
19PCA07Q	15 - 60	1.7 - 6.8	24 - 60	2.7 - 6.8	660	8.5	216	1.51	0.7	1/4"	3/8"	11
19PCA09Q	15 - 79	1.7 - 8.9	24 - 60	2.7 - 8.9	470	9.8	248	1.65	0.7	1/4"	3/8"	11
Trigger Start - P Handle - Clecomatic Clutch												
19PTA02Q	5 - 19	0.6 - 2.1	5 - 19	0.6 - 2.1	2800	8.0	204	1.41	0.6	1/4"	3/8"	11
19PTA03Q	5 - 26	0.6 - 2.9	5 - 19	0.6 - 2.1	1900	8.2	209	1.51	0.7	1/4"	3/8"	11
19PTA04Q	10 - 40	1.1 - 4.5	10 - 38	1.1 - 4.3	1100	8.0	204	1.41	0.6	1/4"	3/8"	11
19PTA05Q	10 - 45	1.1 - 5.1	10 - 38	1.1 - 4.3	660	8.4	214	1.51	0.7	1/4"	3/8"	11
19PTA06Q	10 - 45	1.1 - 5.1	10 - 38	1.1 - 4.3	260	8.4	214	1.51	0.7	1/4"	3/8"	11
19PTA07Q	15 - 60	1.7 - 6.8	24 - 60	2.7 - 6.8	660	8.4	214	1.51	0.7	1/4"	3/8"	11
19PTA09Q	15 - 79	1.7 - 8.9	24 - 79	2.7 - 8.9	470	9.8	248	1.65	0.7	1/4"	3/8"	11
19PTA15Q	45 - 130	5.1 - 14.7	45 - 130	5.1 - 14.7	260	9.7	247	1.91	0.9	1/4"	3/8"	11

General: Tool performance rated at 90 psi (620kPa) air pressure. Dead handle on models above 100 in.-lbs. torque cap. All torque springs required to meet indicated torque specification. Torque Springs: Page 13 Torque Signal Kit: 302021PT (Trigger w/Clecomatic clutch only)

Standard Equipment: Operating instructions & service manual Suspension bail

Optional Equipment: Additional accessories: Pages 12-13

Pistol Grip Screwdrivers

88 & 35 Series Clecomatic Clutch

Cleco®

88 Series

Torque Range: 1.7 – 20 Nm 15 – 180 In. Lbs.

- Quick change and square drive
- Reversible
- Trigger and Push & Trigger start



35 Series

Torque Range: 1.7 – 20 Nm 15 – 180 In. Lbs.

- Pistol grip
- Quick change and square drive
- Reversible
- Trigger, Push-to-Start and Push & Trigger start

Model Number		Torque Range		Free Speed	Length		Weight		Air Consumption		
1/4" Hex Quick Change	3/8" Square Drive	in.-lbs.	Nm	RPM	in.	mm	lbs.	kg	Air Inlet	Min.	SCFM
									NPT	Hose I.D.	
Push and Trigger Start - Sliding Knob Reverse											
88RSAPT-7CQ		15 - 95	1.7 - 10	550	9.0	229	3.1	1.4	1/4"	1/4"	19
88RSAPT-5CQ	88RSAPT-5C-3	15 - 160	1.7 - 18	400	9.0	229	3.1	1.4	1/4"	1/4"	19
88RSAPT-2CQ		15 - 180	1.7 - 20	200	9.8	248	3.4	1.5	1/4"	1/4"	19
Trigger Start - Sliding Knob Reverse											
88RSATP-7CQ	88RSATP-7C-3	15 - 95	1.7 - 10	550	8.9	225	3.1	1.4	1/4"	1/4"	19
88RSATP-5CQ	88RSATP-5C-3	15 - 160	1.7 - 18	400	8.9	225	3.1	1.4	1/4"	1/4"	19
88RSATP-2CQ	88RSATP-2C-3	15 - 180	1.7 - 20	200	9.6	245	3.4	1.5	1/4"	1/4"	19

General:

Tool performance rated at 90 psi (620kPa).
Weight does not include dead handle

Standard Equipment:

Operating instructions & service manual
Dead handle on all models above 100 in.lbs. torque
All torque springs required to meet indicated torque

Standard Equipment if Specified:

Dead handle (861006)

Optional Equipment:

Additional accessories: Pages 12-13
Bits & finders: Page 12
Torque Springs: Page 13

Model Number		Torque Range		Free Speed	Length		Weight		Air Consumption		
1/4" Hex Quick Change	3/8" Square Drive	in.-lbs.	Nm	RPM	in.	mm	lbs.	kg	Air Inlet	Min.	SCFM
									NPT	Hose I.D.	
Push-to-Start - Sliding Knob Reverse											
35RSAP-10Q		15 - 110	2 - 12	770	9.9	251	3.4	1.5	1/4"	5/16"	24
35RSAP-7Q		15 - 160	2 - 18	510	9.9	251	3.4	1.5	1/4"	5/16"	24
Push and Trigger Start - Sliding Knob Reverse											
35RSAPT-7Q		15 - 160	2 - 18	500	9.9	251	3.4	1.5	1/4"	5/16"	24
35RSAPT-5Q		15 - 180	2 - 20	350	9.9	251	3.4	1.5	1/4"	5/16"	24
Trigger Start - Sliding Knob Reverse											
35RSATP-20Q		15 - 60	2 - 7	1500	9.0	229	3.1	1.4	1/4"	5/16"	24
35RSATP-10Q	35RSATP-10-3	15 - 110	2 - 12	750	9.8	248	3.4	1.5	1/4"	5/16"	24
35RSATP-7Q		15 - 160	2 - 18	500	9.8	248	3.4	1.5	1/4"	5/16"	24
35RSATP-5Q	35RSATP-5-3	15 - 180	2 - 20	350	9.8	248	3.4	1.5	1/4"	5/16"	24

General:

Tool performance rated at 90 psi (620kPa).
Weight does not include dead handle

Standard Equipment:

Operating instructions & service manual
Dead handle on all models above 100 in.lbs. torque
All torque springs required to meet indicated torque

Standard Equipment if Specified:

Dead handle (861006)

Optional Equipment:

Additional accessories: Pages 12-13
Torque Springs: Page 13

Screwdrivers

19 & 8 Series Stall

Cleco®

19 Series Stall

Torque Range: 2.1 – 7.9 Nm 19 – 70 In. Lbs.

- 1/4" hex quick change drive
- Trigger start
- "P" and "T" style handles (19 series)
- 2 interchangeable soft-touch grip sizes (19 Series)
- Adjustable reverse lever for true one-hand - left or right - operation (19 series)
- Sliding knob or push button reverse (8 series)



Model Number	Torque Range		Free Speed	Length		Weight		Air Consumption		
	in.-lbs.	Nm	RPM	in.	mm	lbs.	kg	Air Inlet NPT	Min. Hose I.D.	SCFM
1/4" Quick Change										
Trigger Start - T Handle - Sliding Knob Reverse										
19TTS02Q	19	2.1	2800	5.8	146	1.19	0.5	1/4"	3/8"	11
19TTS03Q	26	2.9	1900	6.1	154	1.19	0.5	1/4"	3/8"	11
19TTS04Q	40	4.5	1100	5.8	146	1.19	0.5	1/4"	3/8"	11
19TTS05Q	45	5.1	660	6.1	154	1.19	0.5	1/4"	3/8"	11
8RNP-20BQ	44	5.0	1800	5.4	137	2.1	1.0	1/4"	1/4"	19
8RNP-10BQ	70	7.9	800	6.1	156	2.4	1.1	1/4"	1/4"	19
Trigger Start - P Handle - Sliding Knob Reverse										
19PTS02Q	19	2.1	2800	5.9	150	1.16	0.5	1/4"	3/8"	11
19PTS03Q	26	2.9	1900	6.1	155	1.16	0.5	1/4"	3/8"	11
19PTS04Q	40	4.5	1100	5.9	150	1.16	0.5	1/4"	3/8"	11
19PTS05Q	45	5.1	660	6.1	155	1.16	0.5	1/4"	3/8"	11

General:

Tool performance rated at 90 psi (620kPa).

Standard Equipment:

Operating instructions & service manual
Suspension bail

All torque springs required to meet indicated torque

Dead handle on all models above 100 in.lbs. torque

Standard Equipment if Specified:

Dead handle (861006; 8 series models)

Optional Equipment:

Additional accessories: Pages 12-13
Bits: Page 12

Screwdriver Accessories

Standard and Extended Flat Bits and Finders

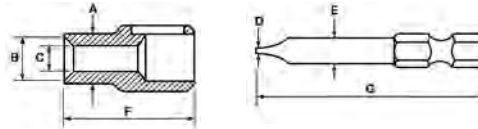

Screw Size	Standard Length (F=1 3/16 in.; G= 1 15/16 in.)		Finder Dimensions (in.)			Bit Dimensions (in.)		Extended Length (F=2 1/4 in.; G= 3 in.)	
	Bit No.	Finder No.	A	B	C	D	E	Bit No.	Finder No.
1F- 2R	849617	847299	.22	.169	.128	.026	.122	849891	847481
2F- 3R	849843	863242	.250	.196	.140	.028	.134	849879	847480
3F- 4R	849618	847300	.285	.228	.160	.032	.154	849892	847482
4F- 5R	849153	847301	.315	.259	.193	.034	.187	849893	847483
5F- 6R	849619	847302	.345	.291	.221	.036	.215	849894	847484
6F- 8R	849154	847303	.380	.323	.256	.038	.250	849895	847485
8F-10R	849620	847294	.445	.386	.281	.042	.275	849896	847486
10F-12R	849155	847304	.530	.431	.318	.046	.312	849897	847487
12F-14R	849156	847305	.590	.513	.366	.050	.360	849898	847488

Finder Springs

Light Force

844000

Medium Force

865728

Phillips Bits and Support Bushings



Phillips Bit Point Size	Bit Body Diameter (in.)	Phillips Bit Part No.	Support Bushing* Part No.
Standard: 1/4 in. Hex Shank Bit – 2 3/4 in. O.A. Length; Bushing – 1 3/16 in. O.A. Length			
1	3/16	809451	847301
2	1/4	809470	847303
3	5/16	809471	847304
Extended: 1/4 in. Hex Shank Bit – 3 1/2 in. O.A. Length; Bushing – 2 1/4 in. O.A. Length			
1	3/16	809453	847483
2	1/4	809473	847485
3	5/16	809474	847487

*Bushing not required on Quick Change models.

Bit Holders and Support Bushings



1/4" Hex Drive Magnetic Bit Holder
Part No. 849325 (2 3/8" O.A. Length)
Magnetic Support Bushing* Part No. 849621
Nonmagnetic Support Bushing* Part No. 847245
Quick-Change Bushing Part No. 201203
Fits all finder type tools except No. 2 Screwdriver
*Bushing not required on Quick Change models.

Screw Sizes & Types



Screw Size	Approximate Thread Body Diameter (inches)	Maximum Head Diameter (inches)							Width of Slot Max. - Min. (inches)
		Round Head	Flat Head	Oval Head	Fillister Head	Pan Head	Binding Head	Truss Head	
0	.058	.113	.119	.119	.096	.116	-	.131	.023 - .016
1	.071	.138	.146	.146	.118	.142	-	.164	.026 - .019
2	.084	.162	.172	.172	.140	.167	.181	.194	.031 - .023
3	.096	.187	.199	.199	.161	.193	.208	.226	.035 - .027
4	.109	.211	.225	.225	.183	.219	.235	.257	.039 - .031
5	.122	.236	.252	.252	.205	.245	.263	.289	.043 - .035
6	.135	.260	.279	.279	.226	.270	.290	.321	.048 - .039
8	.161	.309	.332	.332	.270	.322	.344	.384	.054 - .045
10	.187	.359	.385	.385	.313	.373	.399	.448	.060 - .050
12	.213	.408	.438	.438	.357	.425	.454	.511	.067 - .056
1/4	.247	.472	.507	.507	.414	.492	.513	.573	.075 - .064
5/16	.309	.590	.635	.635	.518	.615	.641	.698	.084 - .072

Screwdriver Accessories



Inline Screwdriver Clutch Torque Springs

Spring Color	Torque Range		Ordering No.
	In. Lbs.	Nm	
2 Series			
Blue	1.5-.5	17-.06	202870
Green	8-1	.9-.1	202869
19 Series			
Green	19-5	--	207652PT
White	38-10	4.3-1.1	207596PT
Orange	45-15	5.1-1.7	207696PT
8 Series			
Blue	17-7	1.9-.8	869203
Green	55-15	6.2-1.7	867938
Red	75-35	8.5-4	867931
88, 35 Series			
Green	55-15	6-2	202822
Yellow	160-35	18-4	869306
Red	180-60	20-7	869305

Note: Torque listed is immediately after the clutch and does not take into consideration torque multiplication after the clutch, such as additional planetary gears or right angle heads.



207019

Exhaust Overhose & Adapter



869204

Order No.	Description	Used On
207019	Overhose	19 series inline & right angle
869204	Adapter	8, 88, 35 series inline, push-to-start

Piped Away Exhaust Hose Adapter



203632

Order No.	Used On
203632	5 series inline
203808	8, 88, 35 series inline p-t-start

Dead Handle

Ordering No.	Used On
201770	5 series, 19 series
861006	8, 88, 35 series



861006

Handle Grips

Order No.	Grip Type	Used On
202464	Round inline	2 series
869734	Round inline	5 series
203621	Tri-roundular inline	5 series
202346	Round inline	8 series p-t-start
203762	Pistol grip	5 series
203833	Pistol grip	8, 88, 35 series

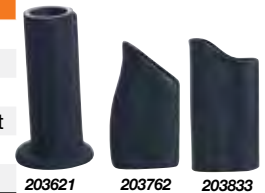

203621

203762

203833

Suspension Bails

Order No.	Used On
931962	19 series
869168	2 series
865777	5 series inline & 8, 88 series inline push-to-start
412603	5 series pistol grip & 8, 88 series inline lever start



412603

931962

Torque Signal Kits

Part No.	Tool Used On
301106	19SCA & 19RAA series (inline & right angle)
302021PT	19TTA & 19PTA series (pistol "P" handle or "T" handle)

Portable Tool Balancers

Part Number	Capacity		Net Weight	Min. Distance Hook to Hook	Length of Working Cable
	Max.	Min.			
200427	2 lbs.	0 lbs.	1.25 lbs.	10.8 in.	5.0 ft.
200428	4 lbs.	2 lbs.	1.25 lbs.	10.8 in.	5.0 ft.
200429	5 lbs.	3 lbs.	1.25 lbs.	10.8 in.	5.0 ft.
PL-12A	12 lbs.	1 lbs.	-	6.8 in.	4.6 ft.
BL-2A	2 lbs.	1 lbs.	1.1 lbs.	10.4 in.	5.2 ft.
BL-4A	4 lbs.	2 lbs.	1.1 lbs.	10.4 in.	5.2 ft.



200427



PL-12A



BL-2A

Screwdrivers

Model Number Nomenclature

Cleco 2 Series

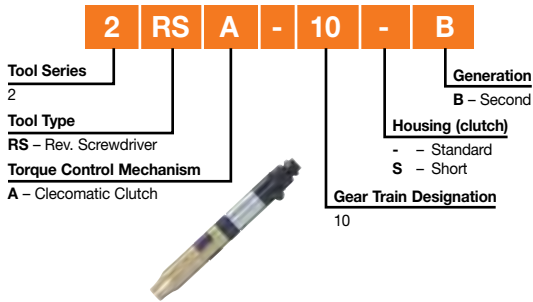

Cleco 19 Series Inline

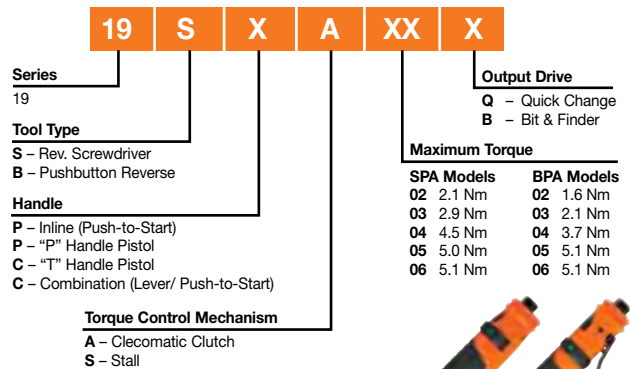

Cleco 19 Series Pistol

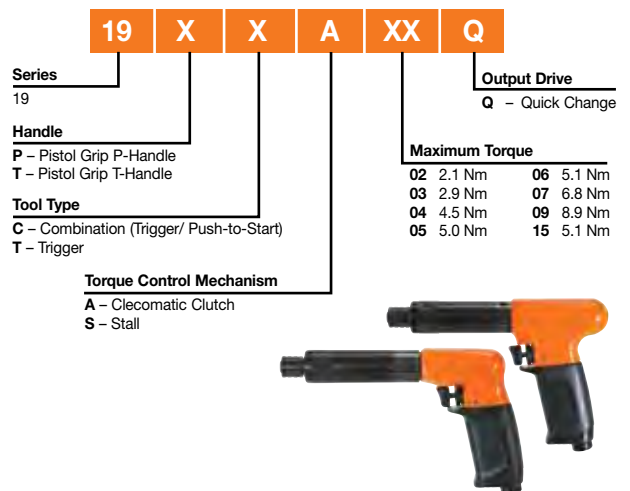

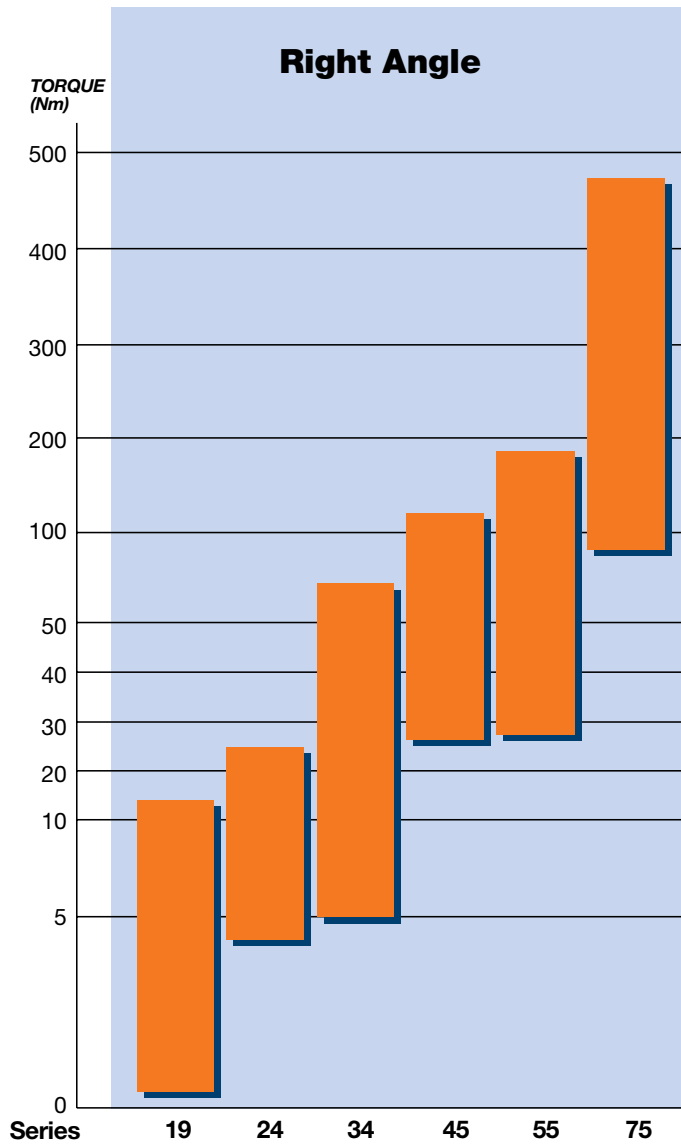

Cleco®

Selecting Your Cleco Nutrunner

Cleco offers over 500 nutrunners, most of which can be equipped with a wide variety of drive options. This generates over 3,000 different nutrunner combinations, allowing the exact tool with precise features to be chosen for specific job applications.

The following items should be considered before selecting the tool: ergonomic factors associated with the man/tool/task relationship, torque and speed requirements, tool and fastener accessibility, fastener joint variations, operator skill level and air supply.

Tool performance can be affected by air supply. Plant air line pressure to the tool will vary widely due to several factors: distance of tool from compressor; size of transmission lines, air drops, manifolds, hose length and diameter, and fittings. All power tool specifications are based on the tool receiving air at 90 p.s.i.g. (6.2 bar) with adequate air flow volume while the tool is in operation.

Clean Operation

Many Cleco angle nutrunners are equipped with oilless blades. This is a very important feature where a clean assembly operation is critical.



Angle Nutrunners

Clecomatic Nutrunners

Clecomatic nutrunners shut off the instant the clutch reaches its adjustable preset torque. This action provides an accurate method of controlling torque without sacrificing tool speed.

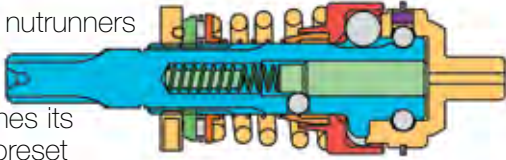

Stall Nutrunners

Stall-type nutrunners consist of an air motor connected to the output spindle by planetary gearing and angle heads. In operation, the tool runs down the fastener until the torque resistance in the fastener causes the tool to stall. When the tool stalls, the throttle is released by the operator and the tool is removed. Stall-type tools can produce accurate torques, especially on applications with varying torque rates; however, their torque output can be

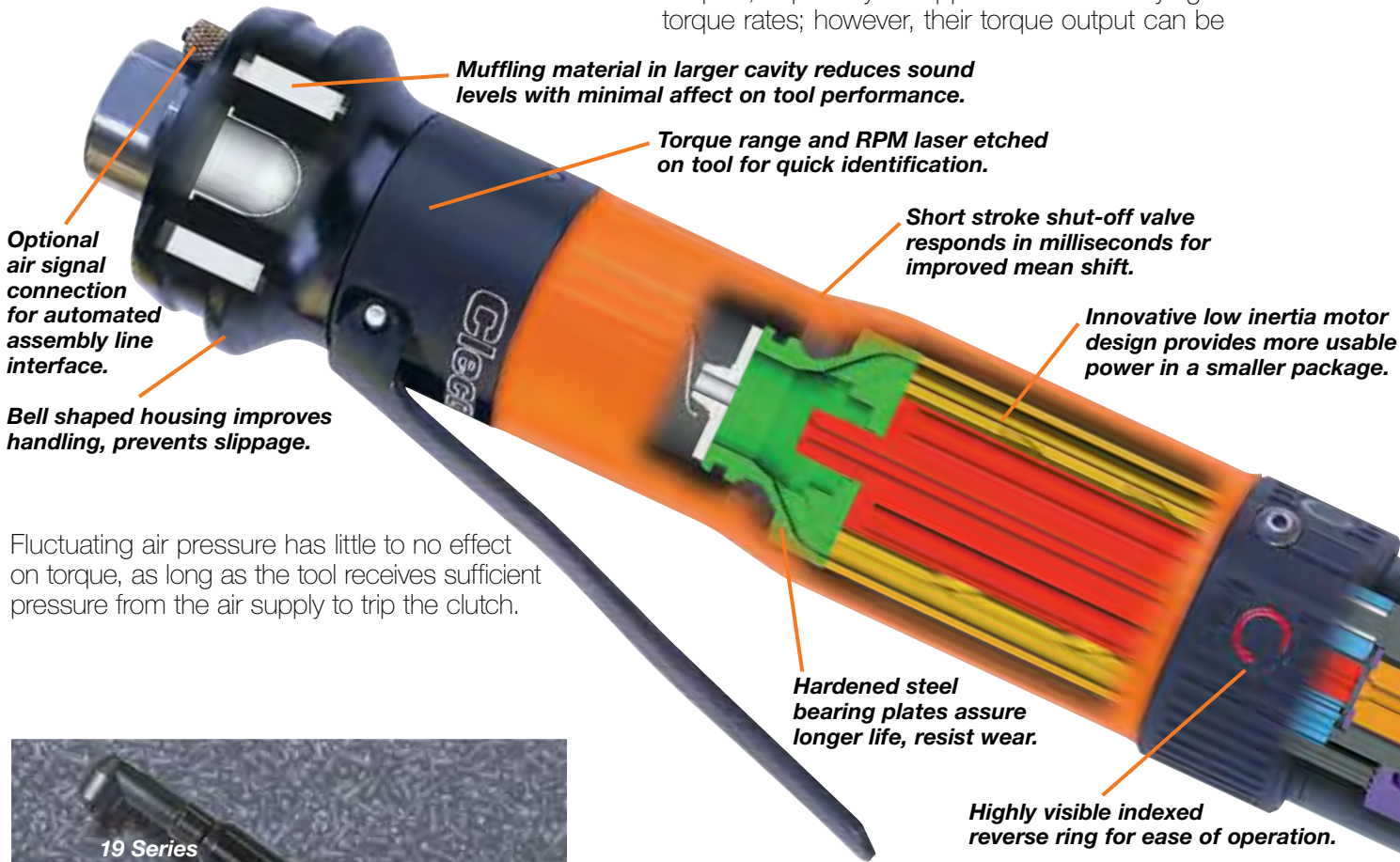

Fluctuating air pressure has little to no effect on torque, as long as the tool receives sufficient pressure from the air supply to trip the clutch.



easily influenced by the operator and by fluctuations in the air line pressure. Operators should be instructed to allow the tool to stall before releasing the throttle and to avoid pulling or wrenching the tool after it stalls.

The Cleco Right Angle Solution

The Cleco 19, 24 and 34 series pneumatic nutrunners are the most recent additions to our line of smaller, lighter and faster tools. These powerful right angle clutch tools cover a wide torque range from .5 to 68 NM. We continue to drive our line into the best power to weight ratio of any other tool in the market, in a relentless effort to offer the most performance, the highest level of accuracy and the greatest flexibility in its class of pneumatic tools.

We also design our tools to offer you reduced energy costs, longer operating life, fewer replacement parts and lower service costs.

Performance

The Cleco 19, 24 and 34 series right angle nutrunners incorporate an innovative motor design that provides more usable power in a smaller package. This design contributes greatly to our smaller, lighter, faster goals and provides the highest power to weight ratio in its class to date.



Flexibility

Cleco nutrunners come with an externally adjusted and indicated clutch and offer improved ergonomics with a very comfortable handle area. The polymer coated angle heads on the 24 and 34 series reduce in-system damage. These durable heads are splined to allow indexing for better position. The operator will appreciate a quieter tool thanks to the composite exhaust deflector which also allows the exhaust to be efficiently piped away for even further reduced noise levels. These noted improvements are geared towards enhancing the tools positive operational features while reducing operator fatigue.

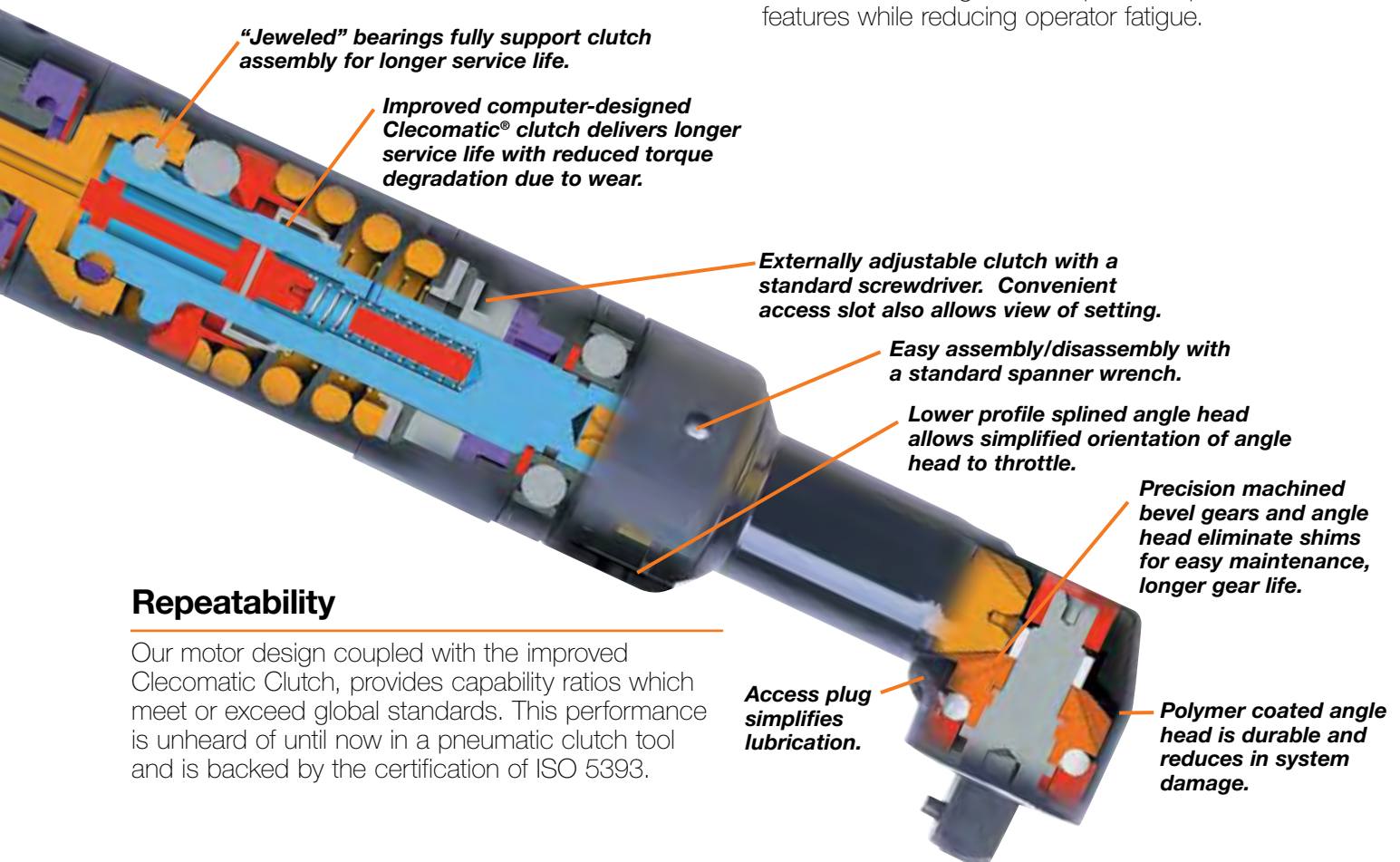

“Jeweled” bearings fully support clutch assembly for longer service life.

Improved computer-designed Clecomatic® clutch delivers longer service life with reduced torque degradation due to wear.

Externally adjustable clutch with a standard screwdriver. Convenient access slot also allows view of setting.

Easy assembly/disassembly with a standard spanner wrench.

Lower profile splined angle head allows simplified orientation of angle head to throttle.

Precision machined bevel gears and angle head eliminate shims for easy maintenance, longer gear life.

Access plug simplifies lubrication.

Polymer coated angle head is durable and reduces in system damage.

Repeatability

Our motor design coupled with the improved Clecomatic Clutch, provides capability ratios which meet or exceed global standards. This performance is unheard of until now in a pneumatic clutch tool and is backed by the certification of ISO 5393.

Angle Nutrunners

19, 24 & 34 Series Clecomatic Clutch

Cleco®

19 Series

Torque Range:

0.5 – 11 Nm 4.0 – 100 In. Lbs.

- Class-leading accuracy and repeatability
- External torque adjustment
- Sliding knob reverse
- 1/4" & 3/8" square drive

24 Series

Torque Range:

4.0 – 23 Nm 3.0 – 17 Ft. Lbs.

- External torque adjustment
- 3/8" square drive
- Indexable anglehead
- One torque spring to meet specified torque
- Oilless blades

34 Series

Torque Range:

8.0 – 75 Nm 4.0 – 55 Ft. Lbs.

- External torque adjustment
- 3/8" and 1/2" square drive
- Indexable anglehead
- One torque spring to meet specified torque
- Oilless blades



Model Number Example

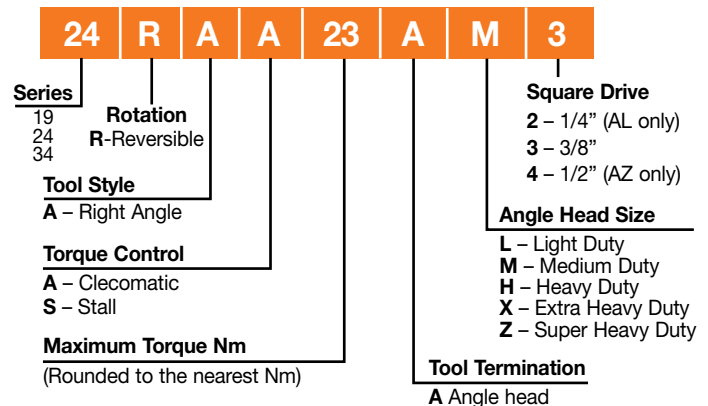

Model Number		Torque Range*				Free Speed	Length		Weight		Head Height		Side to Center		Air Consumption		
1/4" Sq. Dr.	3/8" Sq. Dr.	Tool Range		With Std. Spring			RPM	in.	mm	lbs.	kg	in.	mm	in.	mm	Air Inlet NPT	Min. Hose I.D.
19 Series - Reversible – Clecomatic Clutch																	
19RAA02AM2		5 - 19	0.6 - 2.1	5 - 19	0.6 - 2.1	2400	11.9	303	1.7	0.8	1.06	27	0.36	9	1/8"	3/16"	11
19RAA02AH2	19RAA02AH3	6 - 21	0.7 - 2.4	6 - 21	0.7 - 2.4	2100	12.5	316	1.8	0.8	1.19	30	0.50	13	1/8"	3/16"	11
19RAA03AM2		5 - 27	0.6 - 3.1	5 - 21	0.6 - 2.4	1650	12.2	310	1.8	0.8	1.06	27	0.36	9	1/8"	3/16"	11
19RAA03AH2	19RAA03AH3	6 - 30	0.7 - 3.4	6 - 24	0.7 - 2.7	1450	12.7	321	1.8	0.8	1.19	30	0.50	13	1/8"	3/16"	11
19RAA04AM2		12 - 42	1.4 - 4.7	12 - 42	1.4 - 4.7	950	12.0	305	1.7	0.8	1.06	27	0.36	9	1/8"	3/16"	11
19RAA05AM2		12 - 50	1.4 - 5.7	12 - 42	1.4 - 4.7	570	12.4	316	1.8	0.8	1.06	27	0.36	9	1/8"	3/16"	11
19RAA06AH2*	19RAA06AH3	13 - 53	1.5 - 6.0	13 - 48	1.5 - 5.4	850	12.5	316	1.8	0.8	1.19	30	0.50	13	1/8"	3/16"	11
19RAA07AH2*	19RAA07AH3	13 - 60	1.5 - 6.8	13 - 48	1.5 - 5.4	500	12.9	326	1.9	0.9	1.19	30	0.50	13	1/8"	3/16"	11
19RAA09AH2*	19RAA09AH3	18 - 75	2.0 - 8.5	30 - 75	3.4 - 8.5	500	12.9	326	1.9	0.9	1.19	30	0.50	13	1/8"	3/16"	11
19RAA11AH2*	19RAA11AH3	18 - 100	2.0 - 11.3	30 - 100	3.4 - 11.3	340	12.3	312	2.1	1.0	1.19	30	0.50	13	1/8"	3/16"	11
19RAA12AH2*	19RAA12AH3	18 - 100	2.0 - 11.3	30 - 100	3.4 - 11.3	200	12.9	326	1.9	0.9	1.19	30	0.50	13	1/8"	3/16"	11

*Applications greater than 50 in.-lbs. may affect spindle/drive durability.

General:

Tool performance rated at 90 psi (620kPa) air pressure.

Standard Equipment:

Operating instructions & service manual.

Suspension bail.

All torque springs required to meet indicated torque specification.

Optional Equipment:

Additional accessories: Page 36

Non-Reverse Kit: 207030

Torque Signal Kit: 301106 (Clecomatic clutch only)

Overhose: 207019

Quick Change and 1/4" magnetic hex outputs available on AH3 models only.

Quick Change: Change AH3 to AHQ

1/4" Magnetic Hex: Change AH3 to AHM

Model Number		Torque Range		Free Speed	Length		Weight		Head Height		Side to Center		Air Consumption		
3/8" Sq. Dr.	1/2" Sq. Dr.	ft.-lbs.	Nm		RPM	in.	mm	lbs.	kg	in.	mm	in.	mm	Air Inlet NPT	Min. Hose I.D.
24 Series – Reversible – Clecomatic Clutch															
24RAA06AL3		3-4	4-5.5	2200	14.1	358	2.6	1.2	1.08	27.5	.47	12.0	3/8"	5/16"	24
24RAA07AL3		3-5	5-7	1770	14.1	358	2.6	1.2	1.08	27.5	.47	12.0	3/8"	5/16"	24
24RAA11AL3		5-8	7-11	1260	14.1	358	2.6	1.2	1.08	27.5	.47	12.0	3/8"	5/16"	24
24RAA12AM3		5-9	6-12	1200	14.2	360	2.8	1.3	1.16	29.5	.52	13.2	3/8"	5/16"	24
24RAA19AM3		7-14	10-19	700	15.0	380	3.2	1.4	1.16	29.5	.52	13.2	3/8"	5/16"	24
24RAA23AM3		9-17	12-23	600	15.0	380	3.2	1.4	1.16	29.5	.52	13.2	3/8"	5/16"	24
34 Series – Reversible – Clecomatic Clutch															
34RAA08AL3		4-6	8-5	2060	14.5	368	2.7	1.2	1.08	27.5	.47	12.0	3/8"	5/16"	34
34RAA11AL3		5-8	7-11	1675	14.5	368	2.7	1.2	1.08	27.5	.47	12.0	3/8"	5/16"	34
34RAA15AM3		7-11	9-15	1185	14.6	370	2.9	1.3	1.16	29.5	.52	13.2	3/8"	5/16"	34
34RAA26AH3		10-19	13-26	710	15.4	390	3.2	1.5	1.22	31.0	.57	14.4	3/8"	5/16"	34
34RAA28AH3		10-20	14-28	580	15.4	390	3.3	1.5	1.22	31.0	.57	14.4	3/8"	5/16"	34
34RAA33AX3		12-24	17-33	545	15.5	393	3.5	1.6	1.36	34.5	.67	17.1	3/8"	5/16"	34
34RAA37AX3		14-27	18-37	480	15.6	397	3.4	1.5	1.36	34.5	.67	17.1	3/8"	5/16"	34
34RAA47AX3		17-35	24-47	385	15.6	397	3.4	1.5	1.36	34.5	.67	17.1	3/8"	5/16"	34
34RAA68AZ3		25-50	34-68	255	16.2	411	3.7	1.7	1.60	41.0	.70	18.0	3/8"	5/16"	34
34RAA75AZ3		28-55	38-75	155	17.0	431	3.9	1.8	1.60	41.0	.70	18.0	3/8"	5/16"	34
	34RAA68AZ4	25-50	34-68	255	16.2	411	3.7	1.7	1.60	41.0	.70	18.0	3/8"	5/16"	34
	34RAA75AZ4	28-55	38-75	155	17.0	431	3.9	1.8	1.60	41.0	.70	18.0	3/8"	5/16"	34

General:

Tool performance rated at 90 psi (620kPa) air pressure.

Standard Equipment:

Operating instructions & service manual

Suspension bail

Clutch adjustment tool

Optional Equipment:

Assembly wrench: 201898

Torque signal kit: 301937PT

Non-reversible kit: 204999

Exhaust Overhose: 204978

Additional accessories: Page 36

Angle Nutrunners

45, 55 & 75 Series Clecomatic Clutch

Cleco®

45 Series

Torque Range:
28 – 115 Nm 21 – 85 Ft. Lbs.

- Button start
- Reversible & non-reversible
- External torque adjustment
- 1/2" square drive

55 Series

Torque Range:
32 – 176 Nm 24 – 130 Ft. Lbs.

- Lever start
- Reversible & non-reversible
- External torque adjustment
- Rotating exhaust deflector
- 1/2" square drive

75 Series

Torque Range:
95 – 430 Nm 70 – 320 Ft. Lbs.

- Lever start
- Reversible & non-reversible
- External torque adjustment
- Rotating exhaust deflector
- 1/2" & 3/4" square drive



45, 55 & 75 Model Number Example

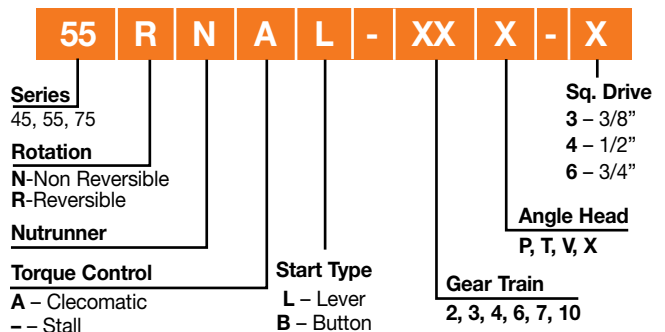

Model Number	Torque Range		Free Speed	Length		Weight		Head Height		Side to Center		Angle Head	Air Consumption			
	1/2" Sq. Dr.	ft.-lbs.		Nm	RPM	in.	mm	lbs.	kg	in.	mm		in.	mm	Air Inlet NPT	Min. Hose I.D.
45 Series – Clecomatic Clutch – Button Start – Reversible																
45RNAB-4T-4		21 - 42	28 - 57	300	17.6	448	6.8	3.1	2.0	50	0.9	22	T	3/8"	3/8"	33
45RNAB-3P-4		26 - 52	35 - 71	240	17.5	445	6.4	2.9	1.6	41	0.7	18	P	3/8"	3/8"	33
45RNAB-3T-4		31 - 62	42 - 84	200	17.6	448	6.8	3.1	2.0	50	0.9	22	T	3/8"	3/8"	33
45RNAB-2P-4		34 - 71*	46 - 96*	180	17.5	445	6.4	2.9	1.6	41	0.7	18	P	3/8"	3/8"	33
45RNAB-2T-4		37 - 85	50 - 115	150	17.6	448	6.8	3.1	2.0	50	0.9	22	T	3/8"	3/8"	33
45 Series Clecomatic Clutch – Button Start – Non-Reversible																
45NAB-3P-4		28 - 57	38 - 77	300	17.5	445	6.3	2.8	1.6	41	0.7	18	P	3/8"	3/8"	33

* Maximum torque of tool exceeds the maximum torque rating for the head, high maintenance should be expected when operated at the upper torque capacity range.

General:
Tool performance rated at 90 psi (620kPa) air pressure.

Standard Equipment:
Operating instructions & service manual.
All torque springs required to meet indicated torque

Optional Equipment:
Additional accessories: Page 36

Model Number		Torque Range		Free Speed	Length		Weight		Head Height		Side to Center		Angle Head	Air Consumption		
1/2" Sq. Dr.	3/4" Sq. Dr.	ft.-lbs.	Nm		RPM	in.	mm	lbs.	kg	in.	mm	in.		mm	Air Inlet NPT	Min. Hose I.D.
55 & 75 Series – Lever Start – Reversible																
		24 - 48	32 - 65	370	19.3	489	7.8	3.5	2.0	50	0.9	22	T	1/2"	1/2"	55
		26 - 54	35 - 73	330	19.1	486	7.4	3.3	1.6	41	0.7	18	P	1/2"	1/2"	55
		29 - 64	39 - 87	280	19.3	489	7.8	3.5	2.0	50	0.9	22	T	1/2"	1/2"	55
		36 - 80*	49 - 109*	220	19.1	486	7.4	3.3	1.6	41	0.7	18	P	1/2"	1/2"	55
		43 - 95	58 - 129	190	19.3	489	7.8	3.5	2.0	50	0.9	22	T	1/2"	1/2"	55
		50 - 125*	81 - 170*	140	19.3	489	7.8	3.5	2.0	50	0.9	22	T	1/2"	1/2"	55
		70 - 140	95 - 190	175	21.9	556	13.3	6.0	2.5	64	1.1	28	V	1/2"	1/2"	70
		90 - 190*	122 - 255*	130	21.9	556	13.3	6.0	2.5	64	1.1	28	V	1/2"	1/2"	70
	75RNAL-3X-6	110 - 225	150 - 305	110	22.6	575	15.0	6.8	2.8	70	1.4	37	X	1/2"	1/2"	70
	75RNAL-2X-6	150 - 305	203 - 410	80	22.6	575	15.0	6.8	2.8	70	1.4	37	X	1/2"	1/2"	70
55 & 75 Series – Lever Start – Non-Reversible																
		28 - 57	38 - 77	480	19.1	486	7.3	3.3	1.6	41	72.0	18	P	1/2"	1/2"	55
		33 - 69	39 - 93	400	19.3	489	7.6	3.5	2.0	50	0.9	22	T	1/2"	1/2"	55
		39 - 84*	49 - 114*	320	19.1	486	7.3	3.3	1.6	41	72.0	18	P	1/2"	1/2"	55
		45 - 100	58 - 136	270	19.3	489	7.6	3.5	2.0	50	0.9	22	T	1/2"	1/2"	55
		55 - 130*	68 - 176*	200	19.3	489	7.6	3.5	2.0	50	0.9	22	T	1/2"	1/2"	55
		100 - 200	135 - 271	210	21.9	556	13.0	5.9	2.5	64	1.1	28	V	1/2"	1/2"	70
	75 NAL-2X-6	160 - 320	215 - 430	130	22.6	575	14.8	6.7	2.8	70	1.4	37	X	1/2"	1/2"	70

* Maximum torque of tool exceeds the maximum torque rating for the head, high maintenance should be expected when operated at the upper torque capacity range.

Standard Equipment:
Operating instructions & service manual
Torque Reaction Mounting Plate (75 series)
All torque springs required to meet indicated torque

Optional Equipment:
Additional accessories: Page 36

General:
Tool performance rated at 90 psi (620kPa) air pressure.

Angle Nutrunners

19, 24, 34, 45, 55 & 75 Series Stall – Reversible & Non-Reversible

Cleco®

19 Series Reversible

Torque Range:

3.2 – 6.2 Nm 2.3 – 4.6 Ft. Lbs.

- Lever start
- Sliding knob reverse

24 Series Reversible

Torque Range:

13 Nm 9.6 Ft. Lbs.

- Lever start
- Twist ring reverse

34 Series Reversible

Torque Range:

11 - 36 Nm 8.1 - 26 Ft. Lbs.

- Lever start
- Twist ring reverse

45 Series Reversible

Torque Range:

62 - 125 Nm 46 - 92 Ft. Lbs.

- Button start
- Twist ring reverse

55 Series Reversible & Non-Reversible

Torque Range:

56 - 203 Nm 41 - 150 Ft. Lbs.

- Lever start
- Reversible & non-reversible

75 Series Reversible & Non-Reversible

Torque Range:

210 - 475 Nm 155 - 350 Ft. Lbs.

- Lever start
- Reversible & non-reversible



Model Number	Max. Torque		Square Drive	Free Speed	Length		Weight		Head Height		Side to Center		Air Consumption		
	ft.-lbs.	Nm			in.	RPM	in.	mm	lbs.	kg	in.	mm	in.	mm	Air Inlet NPT

19 Series – Reversible – Stall

19RAS03AM2	2.3	3.2	1/4	1700	11.4	290	1.3	0.6	1.06	27	0.36	9	1/8"	3/16"	11
19RAS04AH2	2.6*	3.6*	1/4	1500	11.2	284	1.4	0.6	1.19	30	0.5	13	1/8"	3/16"	11
19RAS05AM2	3.8	5.2	1/4	850	10.6	269	1.2	0.5	1.06	27	0.36	9	1/8"	3/16"	11
19RAS06AH3	4.6	6.2	3/8	880	11.0	279	1.3	0.6	1.19	30	0.5	13	1/8"	3/16"	11

45 Series – Reversible – Stall

45RNB-4T-4	46	62	1/2	310	15.1	384	5.5	2.5	2.0	50	0.9	22	3/8"	3/8"	33
45RNB-3P-4	58	79	1/2	250	15.0	381	5.1	2.3	1.6	41	0.7	18	3/8"	3/8"	33
45RNB-3T-4	69	94	1/2	210	15.1	384	5.5	2.5	2.0	50	0.9	22	3/8"	3/8"	33
45RNB-2T-4	92	125	1/2	160	15.1	384	5.5	2.5	2.0	50	0.9	22	3/8"	3/8"	33

24, 34, 55 & 75 Series – Reversible – Stall

34RAS11AL3	8.1	11	3/8	1675	12.0	305	2.1	1.0	1.1	28	0.5	12	3/8"	5/16"	34
24RAS13AM3	9.6	13	3/8	1200	11.7	297	2.2	1.0	1.2	30	0.5	13	3/8"	5/16"	24
34RAS28AH3	20	28	3/8	710	12.9	328	2.6	1.2	1.2	31	0.6	14	3/8"	5/16"	34
34RAS36AX3	26	36	3/8	545	13.0	330	2.8	1.3	1.4	35	0.7	17	3/8"	5/16"	34
55RNL-7T-4	41	56	1/2	490	16.1	410	6.1	2.8	2.0	50	0.9	22	1/2"	1/2"	55
55RNL-3T-4	100*	136*	1/2	195	16.8	425	6.5	2.9	2.0	50	0.9	22	1/2"	1/2"	55
55RNL-2T-4	130*	176*	1/2	145	16.8	425	6.5	2.9	2.0	50	0.9	22	1/2"	1/2"	55
75RNL-3V-4	155	210	1/2	190	19.4	492	11.4	5.2	2.5	64	1.1	28	1/2"	1/2"	70
75RNL-3X-6	245	330	3/4	120	20.1	511	13.1	6.0	2.8	70	1.4	37	1/2"	1/2"	70
75RNL-2X-6	325	440	3/4	90	20.1	511	13.1	6.0	2.8	70	1.4	37	1/2"	1/2"	70

* Maximum torque of tool exceeds the maximum torque rating for the head, increased maintenance should be expected when operated at the upper torque capacity range.

General:

Tool performance rated at 90 psi (620kPa) air pressure.

Standard Equipment:

Operating instructions & service manual
Suspension ball (19 series)
Torque reaction mounting plate (75 series)

Optional Equipment:

19 Series: Non-Reverse Kit: 207030
Overhose: 207019

Quick Change and 1/4" magnetic hex outputs available on AH3 models only.
Quick Change: Change AH3 to AHQ
1/4" Magnetic Hex: Change AH3 to AHM
24/34 Series: Assembly wrench: 201898
Non-reverse kit: 204999
Additional accessories: Page 36

Model Number	Max. Torque		Square Drive	Free Speed	Length		Weight		Head Height		Side to Center		Air Consumption		
	ft.-lbs.	Nm			in.	RPM	in.	mm	lbs.	kg	in.	mm	in.	mm	Air Inlet NPT

55 & 75 Series Non-Reversible – Stall

55NL-3T-4	110*	149*	1/2	290	16.8	425	6.4	2.9	2.0	50	0.9	22	1/2"	1/2"	55
55NL-2T-4	150*	203*	1/2	210	16.8	425	6.4	2.9	2.0	50	0.9	22	1/2"	1/2"	55
75NL-3V-4	165	225	1/2	300	19.4	492	11.1	5.0	2.5	64	1.1	28	1/2"	1/2"	70
75NL-2V-4	220*	298*	1/2	230	19.4	492	11.1	5.0	2.5	64	1.1	28	1/2"	1/2"	70
75NL-2X-6	350	475	3/4	140	20.1	511	12.9	5.8	2.8	70	1.4	37	1/2"	1/2"	70

* Maximum torque of tool exceeds the maximum torque rating for the head, high maintenance should be expected when operated at the upper torque capacity range.

General:

Tool performance rated at 90 psi (620kPa) air pressure

Standard Equipment:

Operating instructions & service manual
Torque Reaction Mounting Plate (75 series)

Optional Equipment:

Additional accessories: Page 36
Safety Lever: 201638

19, 24, & 34 Model Number Example

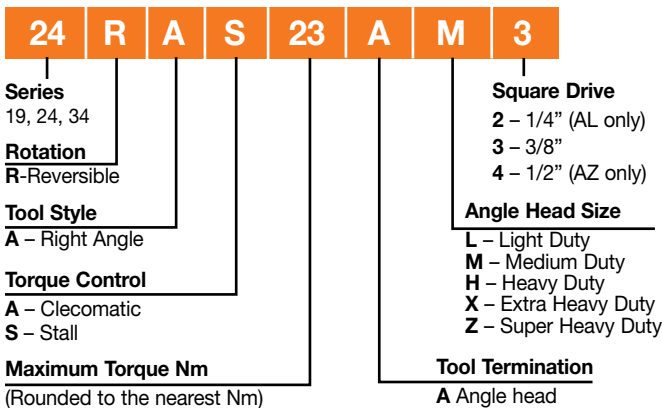

45, 55 & 75 Model Number Example

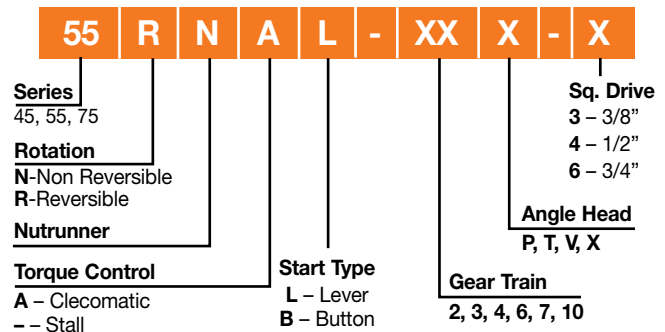

Swingbar Nutrunners

Cleco®

Smaller, Faster, Lighter

For high torque applications where a small tool is necessary, for consistency in clamp load across joint types or for simply eliminating the maintenance needs of an angle tool, the Cleco 64 Series provides the best solution for today's heavy assembly environment.

Benefits of a Swingbar Tool

A swingbar tool includes a reaction bar that freely swings 360°. This allows the reaction bar to be moved to an appropriate bracing point without any disassembly or repositioning of a spline. Once positioned, the reaction bar absorbs the reaction forces of the tool.

Selectork

Output torque from a stall tool is achieved by adjusting the air pressure to the tool. If the tool is

moved from location to location or if other tools requiring full line pressure use the same air line, the tool will require a dedicated air pressure regulator.

The Cleco Selectork feature in the 64 Series tools is a small pressure regulator that takes the place of the standard air inlet bushing and eliminates the need to have a separate pressure regulator installed in the plant floor system. Because of the small size of the Selectork there is a limited pressure adjustment range of from 60 to 90 psi. To order this option on the Cleco 64TTS Swingbar tools replace the "S" in the model number with a "K" (64TTS...to a 64TTK...).

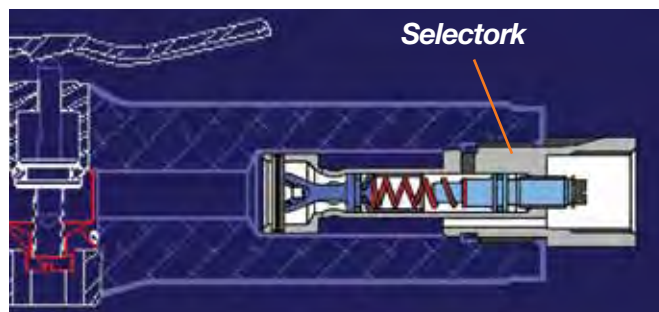

Reversible

A simple to use and convenient slide reverse lever improves productivity by allowing for the loosening of fasteners without changing tools.

Improved Ergonomics

Top and bottom air inlets help customize the 64 Series Reaction Bar Nutrunners to the operator's work area.

Improved Ergonomics

Comfort molded handles and lighter weights reduce operator fatigue and improve productivity

Selectork

for optimal in-tool air pressure regulation.

Ergonomics

Infinite-position reaction bar can quickly be moved to an appropriate brace point, eliminating reaction forces of the rundown.



Torque Bar Opposes Rotation of Tool



Speed and Torque Tests for the Cleco 64 Series Swingbar Nutrunners

The goal of any fastening application is to maintain a high degree of accuracy while minimizing the length of time required to perform the rundown. The Cleco 64 Series Swingbar Nutrunners utilize a single powerful motor that limits speed shifts and offers a fast and accurate rundown regardless of joint type.

Competitive units with high RPM's quickly drop their speed at threshold resulting in an overall longer rundown period. This gap is multiplied when prevailing torque is present.

To read the graphs below, the orange line represents the tool speed while the blue line represents the torque generated throughout a rundown. Notice the correlation between speed and torque and its overall effect on rundown time.

The swingbar can instantly be positioned to absorb the torque reaction of the tool while maintaining a comfortable position with the trigger hand.

Random Comparison on 120° Joint

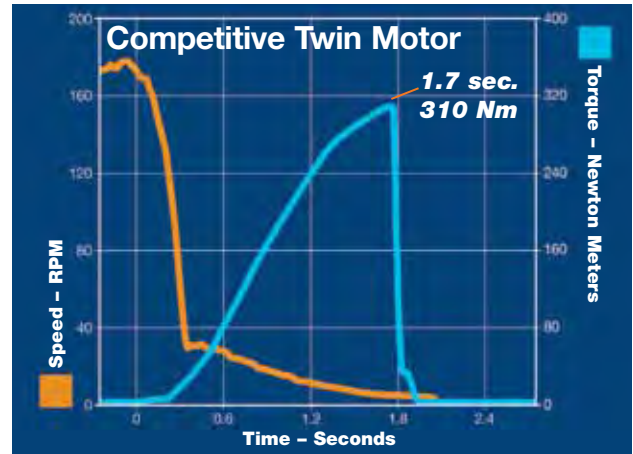
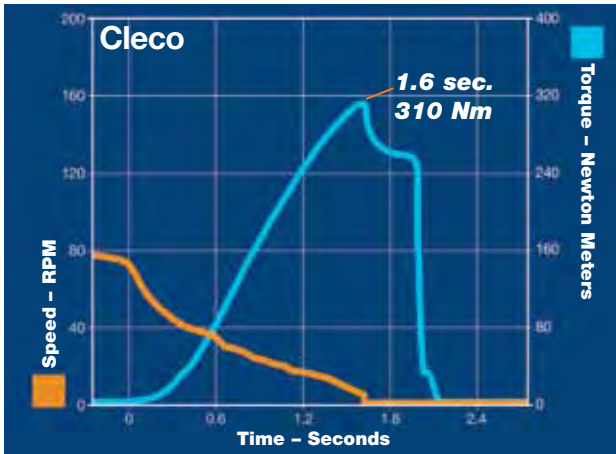

Random Comparison on 720° Joint

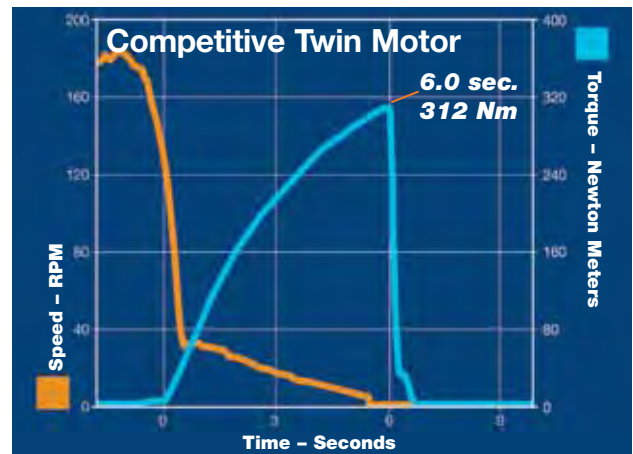
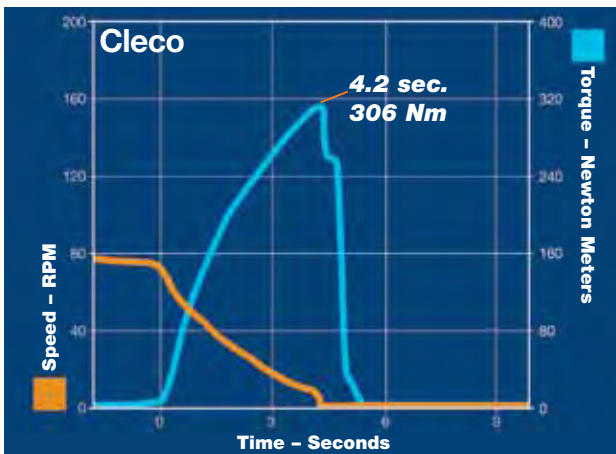

Again the free speed of the Cleco tool is slower, however with its faster tightening speed the overall time is almost 2 seconds faster.



Reaction Bar & Swingbar Nutrunners

Cleco®

45 Series Inline

Torque Range:
14 - 62 Nm 10 - 46 Ft. Lbs.

- Button start
- Twist ring reverse



55 Series Inline

Torque Range:
27 - 91 Nm 20 - 67 Ft. Lbs.

- Lever start
- Twist ring reverse



64 Series Pistol

Torque Range:
34 - 3850 Nm 25 - 2837 Ft. Lbs.

- Trigger start
- Sliding knob reverse
- Swingbar



Selectork 64 Series

Torque Range:
26 - 3850 Nm 19 - 2837 Ft. Lbs.

- Pistol grip
- Reversible
- Swingbar
- Selectork adjustment allows air pressure regulation at the tool for individual performance from a common air line



45 & 55 Model Number Example

55 R N A L - X - X

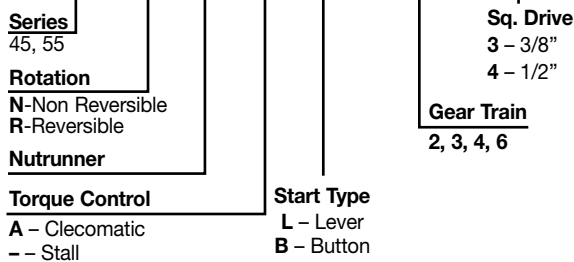

64 Model Number Example

64 T T S XX D X

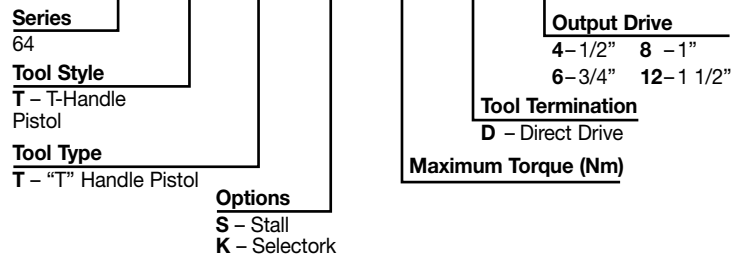

Model Number	Torque Range		Drive Size	Free Speed RPM	Length		Weight*		Air Consumption			
	ft.-lbs.	Nm			in.	mm	lbs.	kg	Air Inlet NPT	Min. Hose I.D.	SCFM	
45 Series – Inline – Clecomatic – Button Start – Twist Ring Reverse												
45RNAB-6-3	10 - 16	14 - 22	3/8	740	14.5	368	5.4	2.4	3/8"	3/8"	33	
45RNAB-4-3	14 - 22	19 - 30	3/8	560	14.5	368	5.4	2.4	3/8"	3/8"	33	
45RNAB-3-3	18 - 33	24 - 45	3/8	370	14.5	368	5.4	2.4	3/8"	3/8"	33	
45RNAB-2-4	23 - 46	31 - 62	1/2	270	14.5	368	5.4	2.4	3/8"	3/8"	33	
55 Series – Inline – Clecomatic – Lever Start – Twist Ring Reverse												
55RNAL-4-4	20 - 34	27 - 46	1/2	560	16.1	410	6.5	3.0	1/2"	1/2"	55	
55RNAL-3-4	25 - 51	34 - 69	1/2	370	16.1	410	6.5	3.0	1/2"	1/2"	55	
55RNAL-2-4	30 - 67	46 - 91	1/2	270	16.1	410	6.5	3.0	1/2"	1/2"	55	

* Weight without reaction bar.

General:

Tool performance rated at 90 psi (620kPa) air pressure

Standard Equipment:

Operating instructions & service manual
Aluminum Torque Reaction Bar

Optional Equipment:

Steel Torque Reaction Bar: 869770
Additional accessories: Page 36

Model Number		Torque Range		Drive Size	Free Speed RPM	Length		Weight*		Air Consumption		
Non-Selectork	Selectork	ft.-lbs.	Nm			in.	mm	lbs.	kg	Air Inlet NPT	Min. Hose I.D.	SCFM
Pistol – Trigger Start – Reversible												
64TTS34D4	64TTK34D4	19 - 25	26 - 34	1/2"	725	11.5	290.8	6.3	2.9	3/8"	1/2"	60
64TTS44D4	64TTK44D4	24 - 32	33 - 44	1/2"	570	11.5	290.8	6.3	2.9	3/8"	1/2"	60
64TTS55D4	64TTK55D4	30 - 41	41 - 55	1/2"	445	11.5	290.8	6.3	2.9	3/8"	1/2"	60
64TTS75D4	64TTK75D4	41 - 55	56 - 75	1/2"	340	11.5	290.8	6.3	2.9	3/8"	1/2"	60
64TTS90D4	64TTK90D4	50 - 66	68 - 90	1/2"	270	11.5	290.8	6.3	2.9	3/8"	1/2"	60
64TTS110D4	64TTK110D4	61 - 81	83 - 110	1/2"	225	11.5	290.8	6.3	2.9	3/8"	1/2"	60
64TTS125D4	64TTK125D4	69 - 92	94 - 125	1/2"	200	11.5	290.8	6.3	2.9	3/8"	1/2"	60
64TTS140D4	64TTK140D4	77 - 103	105 - 140	1/2"	180	11.5	290.8	6.3	2.9	3/8"	1/2"	60
64TTS150D6	64TTK150D6	83 - 111	113 - 150	3/4"	160	12.5	316.2	8.2	3.7	3/8"	1/2"	60
64TTS175D6	64TTK175D6	97 - 129	131 - 175	3/4"	135	12.5	316.2	8.2	3.7	3/8"	1/2"	60
64TTS205D6	64TTK205D6	113 - 151	154 - 205	3/4"	115	12.5	316.2	8.2	3.7	3/8"	1/2"	60
64TTS255D6	64TTK255D6	141 - 188	191 - 255	3/4"	95	12.5	316.2	8.2	3.7	3/8"	1/2"	60
64TTS345D6	64TTK345D6	191 - 254	259 - 345	3/4"	70	12.5	316.2	8.2	3.7	3/8"	1/2"	60
64TTS425D6	64TTK425D6	235 - 313	319 - 425	3/4"	55	12.5	316.2	8.2	3.7	3/8"	1/2"	60
64TTS570D6	64TTK570D6	315 - 420	428 - 570	3/4"	42	13.0	328.9	8.6	3.9	3/8"	1/2"	60
64TTS640D8	64TTK640D8	354 - 472	480 - 640	1"	32	15.9	404.1	14.5	6.6	3/8"	1/2"	60
64TTS750D8	64TTK750D8	415 - 553	563 - 750	1"	27	15.9	404.1	14.5	6.6	3/8"	1/2"	60
64TTS930D8	64TTK930D8	514 - 686	698 - 930	1"	22	15.9	404.1	14.5	6.6	3/8"	1/2"	60
64TTS1260D8	64TTK1260D8	697 - 929	945 - 1260	1"	16	15.9	404.1	14.5	6.6	3/8"	1/2"	60
64TTS1475D8	64TTK1475D8	816 - 1088	1106 - 1475	1"	14	15.9	404.1	14.5	6.6	3/8"	1/2"	60
64TTS1820D8	64TTK1820D8	1007 - 1342	1365 - 1820	1"	11	15.9	404.1	14.5	6.6	3/8"	1/2"	60
64TTS1985D8	64TTK1985D8	1098 - 1464	1489 - 1985	1"	10	15.9	404.1	14.5	6.6	3/8"	1/2"	60
64TTS3850D12	64TTK3850D12	2128 - 2837	2888 - 3850	1 1/2"	5	21.5	546.1	32.2	14.6	3/8"	1/2"	60

* Weight without reaction bar.

General:

Tool performance rated at 90 psi (620kPa) air pressure.

Standard Equipment:

Operating instructions & service manual
Aluminum Torque Reaction Bar
Steel Torque Reaction Bar (tools rated above 50 ft. lbs.)
Slave Square Drive (64TTS3850D12 & 64TTK3850D12)

Optional Equipment:

Steel Torque Reaction Bar: 64.....D4 series: 48047128
Additional accessories: Page 36

Flush Socket Nutrunners

Clecomatic Clutch & Stall

Cleco®

34 Series

Torque Range:
5 – 103 Nm **4 – 76 Ft. Lbs**

- External torque adjustment (Clecomatic models)
- Indexable anglehead
- One torque spring to meet specified range
- Oilless blades
- Reversible



X Dimension For Flush Socket

Head	Inches	Millimeters	Socket Size Range
F1	1.54	39	8–15mm
F2	1.69	43	10–15mm
F3	2.32	59	13–21mm

NOTE: Models listed are examples. Use chart on bottom of facing page for specific model required but not listed.

Model Number	Free Speed RPM	Torque		Length		Weight		Anglehead				Air Consumption		
		ft.-lbs.	Nm	in.	mm	lbs.	kg	Height in. mm	Side to Center in. mm	Air Inlet NPT	Min. Hose I.D.	SCFM		
Clecomatic - Lever Start - Reversible														
34RAA09F1	1825	4-7	5-9	17.0	432	3.7	1.7	1.54	39	0.55	14	3/8"	5/16"	34
34RAA16F1	1055	7-12	9-16	17.0	432	3.7	1.7	1.54	39	0.55	14	3/8"	5/16"	34
34RAA28F1	645	10-20*	14-28*	17.8	452	3.9	1.8	1.54	39	0.55	14	3/8"	5/16"	34
34RAA33F2	540	12-24	17-33	18.8	478	4.7	2.1	1.69	43	0.67	17	3/8"	5/16"	34
34RAA47F2	380	17-35	24-47	19.0	483	5.1	2.3	1.69	43	0.67	17	3/8"	5/16"	34
34RAA53F2	265	17-39	24-53	19.0	483	5.1	2.3	1.69	43	0.67	17	3/8"	5/16"	34
34RAA67F3	265	24-49	33-67	20.5	521	5.8	2.6	2.32	59	0.87	22	3/8"	5/16"	34
34RAA94F3	185	35-69	47-94	20.5	521	5.8	2.6	2.32	59	0.87	22	3/8"	5/16"	34
Stall - Lever Start - Reversible														
34RAS10F1	1825	7	10	17.0	432	3.4	1.5	1.54	39	0.55	14	3/8"	5/16"	34
34RAS18F1	1055	13	18	17.0	432	3.4	1.5	1.54	39	0.55	14	3/8"	5/16"	34
34RAS30F1	645	22*	30*	17.8	452	3.5	1.6	1.54	39	0.55	14	3/8"	5/16"	34
34RAS40F2	480	29	40	19.0	483	4.4	2.0	1.69	43	0.67	17	3/8"	5/16"	34
34RAS52F2	380	38	52	19.0	483	4.4	2.0	1.69	43	0.67	17	3/8"	5/16"	34
34RAS58F3	335	43	58	20.5	521	5.5	2.5	2.32	59	0.87	22	3/8"	5/16"	34
34RAS73F3	265	54	73	20.5	521	5.5	2.5	2.32	59	0.87	22	3/8"	5/16"	34
34RAS103F3	185	76	103	20.5	521	5.5	2.5	2.32	59	0.87	22	3/8"	5/16"	34

* Maximum torque of tool exceeds the maximum torque rating for the head, high maintenance should be expected when operated at the upper torque capacity range.

General:
 Tool performance rated at 90 psi (620kPa) air pressure.

Standard Equipment:
 Operating instructions & service manual
 Suspension bail
 Exhaust Overhose
 Clutch adjustment tool (Clecomatic tools)
 Mounting plate (F3 tools)

Optional Equipment:
 Assembly wrench: 201898
 Torque signal kit: 301937PT
 Non-reversible kit: 204999
 Mounting plates: F1 tools 57217101 57218103
 F2 tools 43287131
 Additional accessories: Page 36

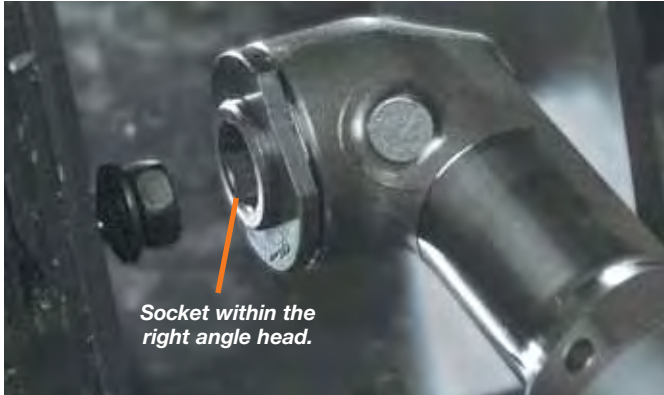

Tight clearance applications, once only accessible by the use of hand tools or crowfoot attachments, can now be tightened by the family of Cleco Flush Socket Pneumatic Tools at a speed that maximizes productivity. Tools equipped with a Clecomatic clutch assure good torque repeatability.

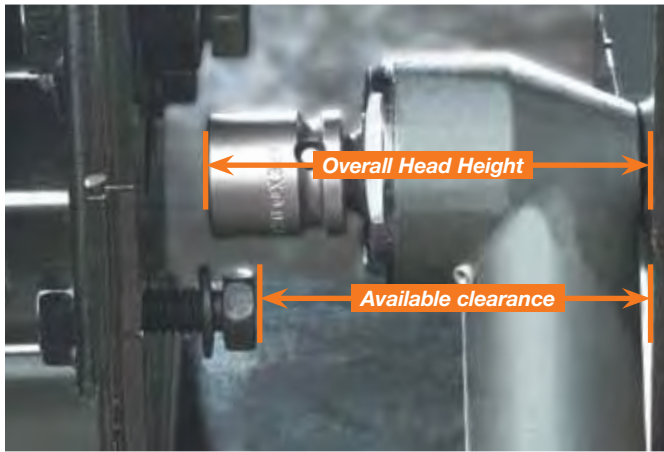

Standard right angle head with square drive and separate socket will not fit on tight clearance applications. The overall head height is greater than the available clearance.

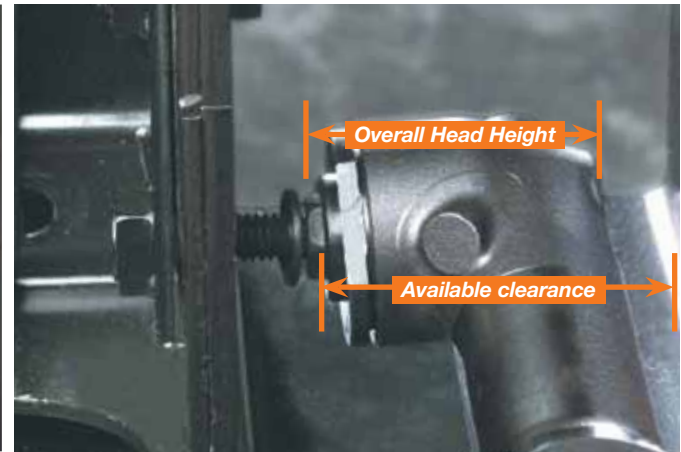

Flush socket tools have plenty of clearance to fit on the same application. Clecomatic flush socket tools tighten with much higher accuracy than tools with crowfoot attachment. The overall head height is less than the available clearance.

Model Number Example

Base Tool

34 R A A 16 F1

Motor

Reversible

Tool Style
A - Angle

Control

A - Clutch
S - Stall

Maximum Torque Output

F1 Clutch: 9, 16, 28 Nm
Stall: 10, 18, 30 Nm

F2 Clutch: 33, 47, 53 Nm
Stall: 40, 52 Nm

F3 Clutch: 67, 94 Nm
Stall: 58, 73, 103 Nm

Flush Socket Head

F1 Head: 8-15 mm socket capacity
F2 Head: 10-15 mm socket capacity
F3 Head: 13-21 mm socket capacity

Socket No. (ordered with base tool)

FS 1 MG 0 0

Flush Socket Head

1 - F1 Head
2 - F2 Head
3 - F3 Head

Socket Type

FS - Flush

Output Type

1-Thru Hex 2-Magnetic

Extension Length

0 - Flush 2 - 1/4" 4 - 1/2" 6 - 3/4"

Socket Sizes

EC - 3/8"	MA - 7mm
ED - 7/16"	MB - 8mm
EE - 1/2"	MC - 9mm
EF - 9/16"	MD - 10mm
	ME - 11mm
	MF - 12mm
	MG - 13mm
	MH - 14mm
	MI - 15mm
	MM - 19mm

Note: When ordering, specify the base tool and order the socket separately. The socket will be installed in the tool before shipment.

Crowfoot Nutrunners

Clecomatic Clutch & Stall

Cleco®

34 Series

Torque Range:
 14 – 30 Nm 10 – 22 Ft. Lbs

- External torque adjustment (Clecomatic models)
- Indexable anglehead
- One torque spring to meet specified range
- Oilless blades
- Reversible



NOTE: Models listed are examples. Use chart on bottom of facing page for specific model required but not listed.

Model Number		Free Speed	Torque Range		Socket Size		Length		Weight		Air Consumption		
15 Degree Head	30 Degree Head	RPM	ft.-lbs.	Nm	in.	mm	in.	mm	lbs.	kg	NPT	I.D.	SCFM
Clecomatic - Lever Start - Reversible													
34RCA30D1	34RCA30D3	425	11-22	15-30	5/16	8	20.0	507	4.7	2.2	3/8"	5/16"	34
Stall - Lever Start - Reversible													
34RCS29D1	34RCS29D3	490	21	29	5/16	8	19.6	497	4.5	2.1	3/8"	5/16"	34

General:
 Tool performance rated at 90 psi (620kPa) air pressure.

Standard Equipment:
 Operating instructions & service manual
 Suspension bail
 Exhaust Overhose
 Clutch adjustment tool (Clecomatic tools)

Extra Equipment:
 Specify socket from page 31

Optional Equipment:
 Assembly wrench: 201898
 Torque signal kit: 301937PT
 Non-reversible kit: 204999
 Additional accessories: Page 36

15° Head

Part Number: 301071

Maximum Recommended

Torque: 22 ft. lbs. (30 Nm)

Standard Length Socket

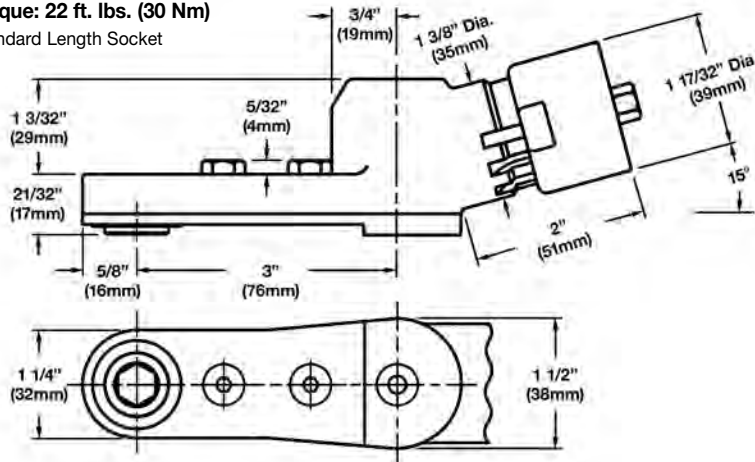

30° Head

Part Number: 301072

Maximum Recommended

Torque: 22 ft. lbs. (30 Nm)

Standard Length Socket

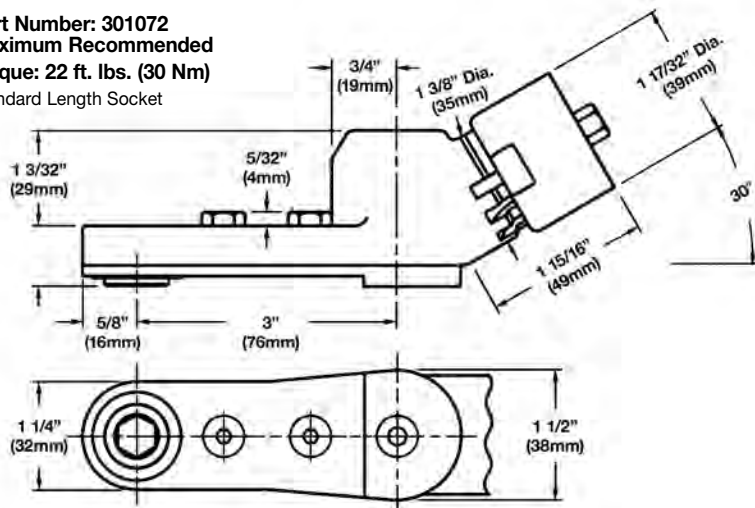

Model Number Example

Base Tool

34 R C A 30 D1

Motor
34

Rotation
R - Reversible

Tool Style
C - Crowfoot

Control

A - Clecomatic
S - Stall

Max Output Torque

Clecomatic: 30
Stall: 14, 29

Tool Termination

D1 15° Head
D3 30° Head

Socket No. (ordered with base tool)

CS XX X X

Crowfoot
Socket

Output Type

1 - Thru Hex

Extension Length

0 - Flush 4 - 1/2" 6 - 3/4"

Sockets

Flush		1/2" Extended	3/4" Extended
EA - 1/4"	MD - 10mm	EB - 5/16"	EE - 1/2"
EC - 3/8"	ME - 11mm	EC - 3/8"	MG - 13mm
ED - 7/16"	MF - 12mm	ED - 7/16"	MH - 14mm
EE - 1/2"	MG - 13mm	EE - 1/2"	
EF - 9/16"	MH - 14mm	EF - 9/16"	
EB - 5/16"	MI - 15mm	MB - 8mm	
EC - 3/8"		MD - 10mm	
ED - 7/16"		ME - 11mm	
EE - 1/2"		MF - 12mm	
EF - 9/16"		MG - 13mm	

Hold & Drive Nutrunners

Clecomatic Clutch & Stall

Cleco®

34 Series

Torque Range:
 24 – 103 Nm 17 – 76 Ft. Lbs

- External torque adjustment (Clecomatic models)
- Indexable anglehead
- One torque spring to meet specified range
- 1" retraction of hold spindle
- Oilless blades
- Reversible

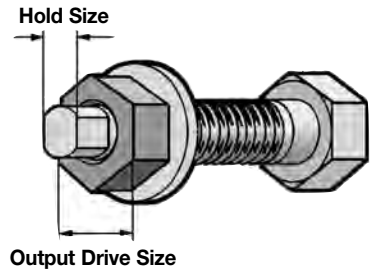

NOTE: Models listed are examples. Use chart on bottom of facing page for specific model required but not listed.

Model Number	Hold Size	Free Speed RPM	Torque		Length		Weight		Anglehead				Air Consumption		
			ft.-lbs.	Nm	in.	mm	lbs.	kg	Height		Side to Center		NPT	Hose I.D.	SCFM
									in.	mm	in.	mm			
Clecomatic - Lever Start - Reversible															
34RAA53H3	5mm Female Hex	335	17-39	24-53	20.7	526	8.0	3.5	2.4	61	1.06	27	3/8"	5/16"	34
34RAA67H3	7mm Female Hex	265	24-49	33-67	20.7	526	8.0	3.5	2.4	61	1.06	27	3/8"	5/16"	34
34RAA94H3	8mm Female Hex	185	35-69	47-94	20.7	526	8.0	3.5	2.4	61	1.06	27	3/8"	5/16"	34
Stall - Lever Start - Reversible															
34RAS58H3	5mm Female Hex	335	43	58	20.7	526	7.7	3.5	2.4	61	1.06	27	3/8"	5/16"	34
34RAS73H3	T30 Torx	265	54	73	20.7	526	7.7	3.5	2.4	61	1.06	27	3/8"	5/16"	34
34RAS103H3	10mm Female Hex	185	76	103	20.7	526	7.7	3.5	2.4	61	1.06	27	3/8"	5/16"	34

General:

Tool performance rated at 90 psi (620kPa) air pressure.

Standard Equipment:

Operating instructions & service manual
 Suspension bail
 Exhaust Overhose
 Clutch adjustment tool (Clecomatic tools)
 Mounting Plate

Optional Equipment:

Assembly wrench: 201898
 Torque signal kit: 301937PT
 Non-reversible kit: 204999
 Additional accessories: Page 36

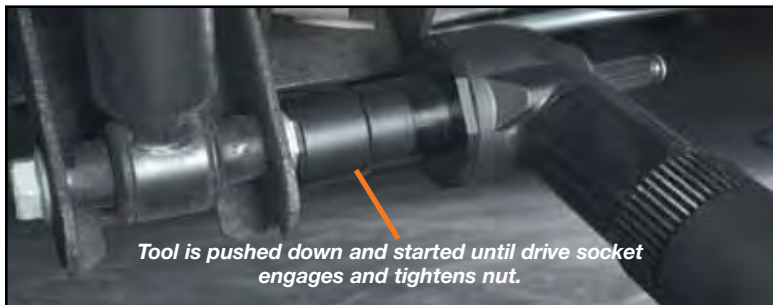
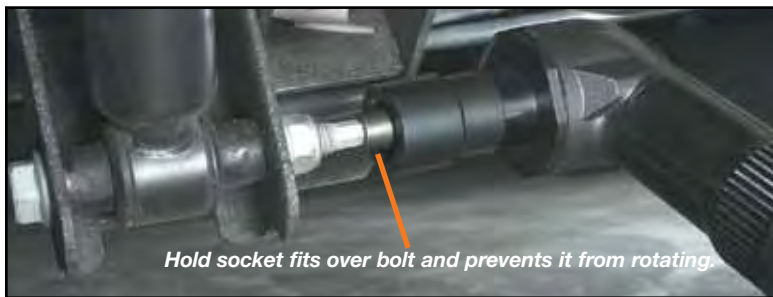

“Hold & Drive” bolts are used with these tools in automotive and truck frame applications. They reduce assembly handling to one person working from one side of the workpiece. The bolt is held stationary by the tool while the nut is tightened from the same side.

Model Number Example

Base Tool						Drive Socket			Hold Socket		
34	R	A	A	53	H	H3	ML	O	M6	B	
Motor	Reversible										Oval Length (for oval only)
	Tool Style										<i>(Example: For a 6mm x 8mm oval, this dimension would be MB, but drop the "M" as in M6B.)</i>
	A - Angle										Hold Socket (dimension across flats, oval also)
Control											EA - 1/4"
A - Clutch											M6 - 6mm
S - Stall											MH - 14mm
Maximum Torque Output											EB - 5/16"
Clutch: 53, 67, 94 Nm											MA - 7mm
Stall: 58, 73, 103 Nm											EC - 3/8"
Tool Termination											MB - 8mm
H - Hold & Drive											ED - 7/16"
											MC - 9mm
											EE - 1/2"
											MD - 10mm
											EF - 9/16"
											ME - 11mm
											EO - 5/8"
											MO - 21mm
											M5 - 5mm
											MG - 13mm
											45 - T45
											<i>(Example: On a 6mm x 8mm oval, this dimension would be MB.)</i>
											Hold Socket Style
											F - Female Hex
											T - Torx
											M - Male Hex
											O - Female oval
											Drive Socket Size
											EE - 1/2"
											EK - 7/8"
											EQ - 1 1/4"
											ML - 18mm
											MR - 24mm
											EF - 9/16"
											EL - 15/16"
											MG - 13mm
											MM - 19mm
											MS - 25mm
											EG - 5/8"
											EM - 1"
											MH - 14mm
											MN - 20mm
											MT - 26mm
											EI - 3/4"
											EH - 11/16"
											EN - 1 1/16"
											MI - 15mm
											MO - 21mm
											MJ - 16mm
											MP - 22mm
											XX - Special
											EJ - 13/16"
											EO - 1 1/8"
											MK - 17mm
											EQ - 1 1/4"
											ML - 18mm
											MR - 24mm
											MM - 19mm
											MS - 25mm
											MN - 20mm
											MT - 26mm
											MU - 27mm
											MP - 22mm
											MQ - 23mm

Note: When ordering, specify the base tool and order the socket separately. The socket will be installed in the tool before shipment.

Tube Nut Wrenches

Clecomatic Clutch

Cleco®

24 Series

Torque Range:
14 - 40 Nm
19 - 54 Ft. Lbs

- One hand, two position throttle
- External torque adjustment
- Auto alignment socket



24 Series (T2)

24 Series (T3)

24 Series (T4)

24 Series Power Unit
With Auto Alignment

Termination

T2, T3 & T4 Head Height

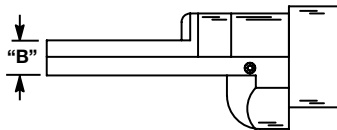

T2 Head

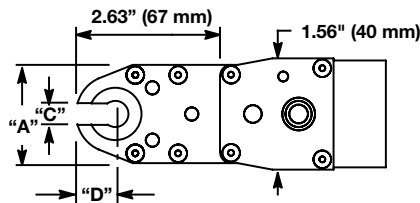

T3 Head

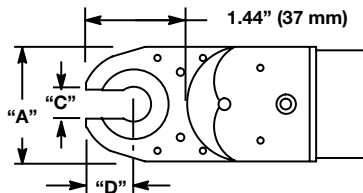

T4 Head

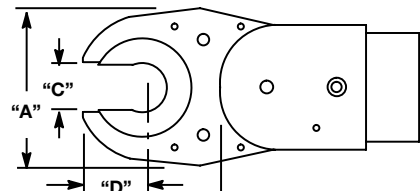

NOTE: Models listed are examples. Use chart on bottom of facing page for specific model required but not listed.

Model Number	Free Speed RPM	Torque Range		Weight		Length		Socket Size		"A"		"B"		"C"*		"D"	
		Ft. Lbs.	Nm	lbs.	kg	in.	mm	in.	mm	in.	mm	in.	mm	in.	mm	in.	mm
Power Unit Only																	
24RTA12	670	3.6 - 8.9	5 - 12	2.7	1.2	12	305	NA	NA	NA	NA	NA	NA	NA	NA	NA	NA
Self Aligning																	
24RTA20T2	240	10.4 - 14.7	14 - 20	4.3	2.0	16.8	426	7/16	—	1.42	36	0.55	14	0.28	7.0	0.53	13.5
24RTA30T3	175	14.7 - 22.1	20 - 30	4.5	2.0	16.7	426	9/16	—	1.65	42	0.59	15	0.47	11.9	0.73	18.5
24RTA40T4	130	19.2 - 29.5	26 - 40	5.1	2.3	17.7	449	7/8	—	2.36	60	0.59	15	0.67	17.0	0.93	23.5

* Varies by socket dimension.

General:

Air Inlet: 1/4" NPT

Tool performance rated at 90 psi (620kPa) air pressure.

Extra Equipment:

Specify socket from page 35

Optional Equipment:

Torque signal kit: 301937PT (see page 39)



Auto Alignment Head

Tube and hose applications, once only accessible by the use of hand tools, can now be tightened by the Cleco family of Tube Nut Wrenches at a speed that maximizes productivity.

Torque repeatability is assured by the proven Clecomatic clutch and low inertia motor. These models use a single lever for the tightening of the fastener and the return of the socket to the open position. The flexibility coupled with the proven capabilities greatly increases the productivity rate of the assembly line.



Make sure that the socket is set to the open position. If not, push the throttle lever down half way to release the socket back to the open position.



Slide the tool on the fastener and push the throttle lever down fully to run the fastener down.



To free the tool, slide the tool off the tightened fastener and operate the throttle lever halfway to release the socket back to the open position.

Model Number Example

Base Tool

24 R T A 20 T2

Motor
24

Tool Style
R – Reversing mechanism for socket orientation

Tool Type
T – Tube Nut

Torque Control
A – Clecomatic Clutch

Max Torque (Nm)
T2 - 20 Nm
T3 - 30 Nm
T4 - 40 Nm

Head Size
T2 - 20 Nm Max.
T3 - 30 Nm Max.
T4 - 40 Nm Max.

Socket (Order Separately)

KS2 ED 0 0

Head Type
KS2 - T2
KS3 - T3
KS4 - T4

Output Type

0 Partial Thru Hex 2 Double Thru Hex
1 Thru Hex 3 Partial Thru Double Hex

Extension Length

0 Flush 4 1/2"
2 1/4" 6 3/4"

Maximum Hex Socket Sizes

MG, 1/2" T2 Head Type
MM, 3/4" T3 Head Type
MU, 1 1/16" T4 Head Type
00, ## (specials) T3 Head Type

Socket Sizes

EA - 1/4"	M5 - 5mm	MK - 17mm
EC - 3/8"	M6 - 6mm	ML - 18mm
ED - 7/16"	MA - 7mm	MM - 19mm
EE - 1/2"	MB - 8mm	MN - 20mm
EF - 9/16"	MD - 10mm	MO - 21mm
EH - 11/16"	ME - 11mm	MP - 22mm
EJ - 13/16"	MF - 12mm	MQ - 23mm
EK - 7/8"	MG - 13mm	MR - 24mm
EL - 15/16"	MH - 14mm	MS - 25mm
EM - 1"	MI - 15mm	MT - 26mm
EO - 1 1/8"	MJ - 16mm (5/8")	MU - 27mm (1 1/16")

Nutrunner Accessories

Torque Reaction Bars & Slave Square Drives

Part No.	Description	Used On
869770	Steel Bar	45, 55 series inline
48047128	Steel Bar	64...D4 series
46037081	Slave Square Drive	64...D4 series
46177030	Slave Square Drive	64...D6 series
46607058	Slave Square Drive	64...D8 series

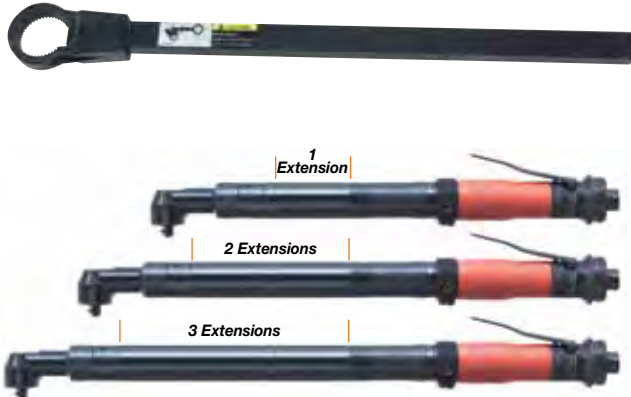

Extension Kit (3.5")

Part No.	Used On
301081	34 series (37 Nm or higher)
301108	24/34 series (36 Nm or lower)

Mounting Brackets (right angle tools)

Part No.	Description	Used On
201012	Torque reaction bracket	45, 55 series
201039	Fixed tooling bracket	45, 55 series
201510	Torque reaction bracket	75 series
201034	Torque reaction bracket	75 series (standard)

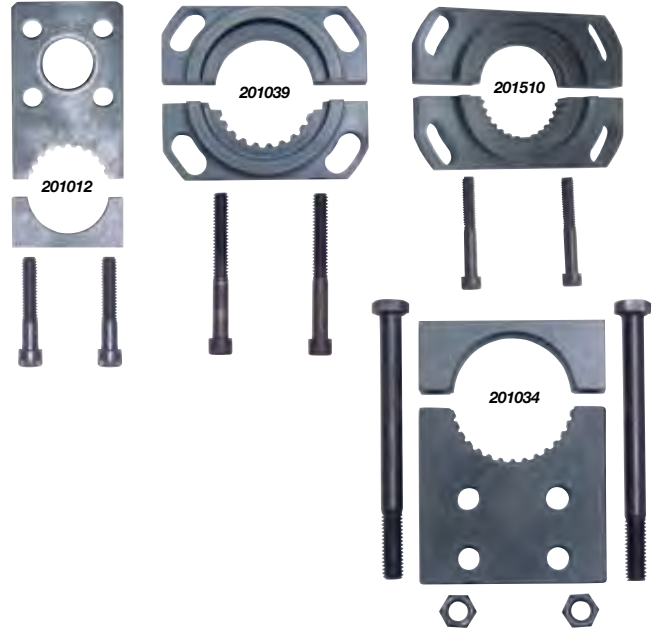

Anglehead Covers

Part No.	Used On	
	Tool Series	Anglehead
205831	24/34	AH, AM
205833	24/34	AX
205834	24/34	AZ
205837	19	AH
205839	45/55	T
205835	45/55	P
205838	75	V



Suspension Bail

Part No.	Used On
867711	8, 35, 45, 55 series
204987	24, 34 wire bail



Swivel Suspension Bail

Part No.	Used On
541715-5	24, 34 series
54397004	64...D4 series
46437006	64...D6 series
46607016	64...D8 series
46037036	64...D12 series



Torque Signal Kit

Air signal to indicate clutch shut-off.

Part No.	Used On
201900	24/34 Clecomatic (old style)
301937PT	24/34 Clecomatic (new style)
301106	14 Clecomatic



Assembly Wrench

Part No.	Used On
201898	Two required



Joint Simulator

Description	Torque Range		Width		Height		Length		Part No.
	ft.-lbs.	Nm	in.	mm	in.	mm	in.	mm	
Joint Simulator	220-12	300-15	10.4	264	16	406	26	667	550006

Accessories

Cleco TVP-100 Series Torque Verifier

Cleco®

The TVP-100 Series Torque Verifier provides low-cost assembly assurance for pneumatic screwdrivers, nutrunners and pulse tools.

The Cleco TVP-100 verifier improves your assembly process by eliminating operator error caused by early trigger release, fastener cross-threading or re-hits.

The TVP-100 is designed for use with pneumatic clutch screwdrivers/nutrunners and Cleco shut-off pulse tools equipped with torque signal kits.

The TVP-100 provides visual and audio feedback

for both individual fastener and batch parameters, assuring that every fastener has been rundown to the capability of the tool.

Based on existing Cleco TME controller technology, the TVP-100 navigational screen allows for simple set-up and operation.

The TVP-100 works by reading the signature of a ported pneumatic assembly tool through its fastening cycle. Any deviation from the normal signature caused by re-hits, cross threads, early trigger release or a number of variables will elicit a **NOK** visual and audio signal from the verifier, notifying the operator of an error. Whereas a Cleco DC controller controls the tool and the fastening process, the TVP-100 is a cost-effective way of verifying torque by following the torque signature of a tool.



Highly visible indicators
(Cycle Accept, Batch Accept, and Reject)

Input/Output
connector for line
process interface.

Air Pressure
Transducer
Connection

Power entry
module with
spare fuse.

Easy-to-read
menu driven
display for ease
of setup and
analysis.



Accessories

Cleco TVP-100 Series Torque Verifier

Features

- Verifies fastener installation with **OK/NOK** audio and visual indicators
- On screen verification of individual fastener assembly status with batch count
- VGA screen displays graph for each rundown
- Stores 1,000 rundowns
- Sequencing capability
- 8 parameter sets available for multiple applications
- "Auto Cal" permits fast and easy tool set up for any joint type
- Password protected
- Multiple languages



TVP-100 Series Torque Verifiers

Model Number		Language	Weight		Width		Height		Depth	
115VAC*	230VAC*		lbs.	kg	in.	mm	in.	mm	in.	mm
TVP-110-15-U	TVP-110-30-U	English	6	2.72	8.75	222	9.13	232	4.13	105
TVP-110-15-D	TVP-110-30-D	German	6	2.72	8.75	222	9.13	232	4.13	105
TVP-110-15-S	TVP-110-30-S	Spanish	6	2.72	8.75	222	9.13	232	4.13	105
TVP-110-15-P	TVP-110-30-P	Portuguese	6	2.72	8.75	222	9.13	232	4.13	105

** 230V units are CE compliant.

All model numbers include power cable, air signal transducer, 25 foot cable to connect TVP to air signal transducer, and 8 foot air line to connect transducer to tool.
NOTE: Tool must be equipped with torque signal kit.

24 Volt Inputs/Outputs:

Inputs: Up to 8 Applications
 Reset
 Suspend

Outputs: Cycle Accept
 Batch Accept
 Reject

Accessories

Cleco TVP-100 Series Torque Verifier

Accessories

Torque Signal Kits

Part No.	Tool Used On
301106	19SCA & 19RAA series
302021PT	19TTA & 19PTA series
201900	24RAA and 34RAA (old style)
301937PT	24RAA and 34RAA (new style)
934918	PTH series pulse tools ("C" & "D" vintage only)

Phoenix Connector

Part No.	Description
542892	24 Volt Input/Output Phoenix connector
939348	Strain relief for above connector

Cables

Part No.	Description
207237	115V Transducer and cable
207238	230V Transducer and cable

**115V and 230V transducer and cable assemblies have different connectors at the TVP end of the cable.*



Ratchet Wrenches

Stall Type

Cleco Ratchet Wrenches. For Applications That Are “Impossible” To Get To.

Extensive variety of ratchet heads.

Miniature, bent left, bent right, extended, thin and extra thin ratchet heads are just some examples of the variety of heads available to ensure that you can gain access to the hardest to reach fasteners...even fasteners that can't be seen can be tightened with precision.

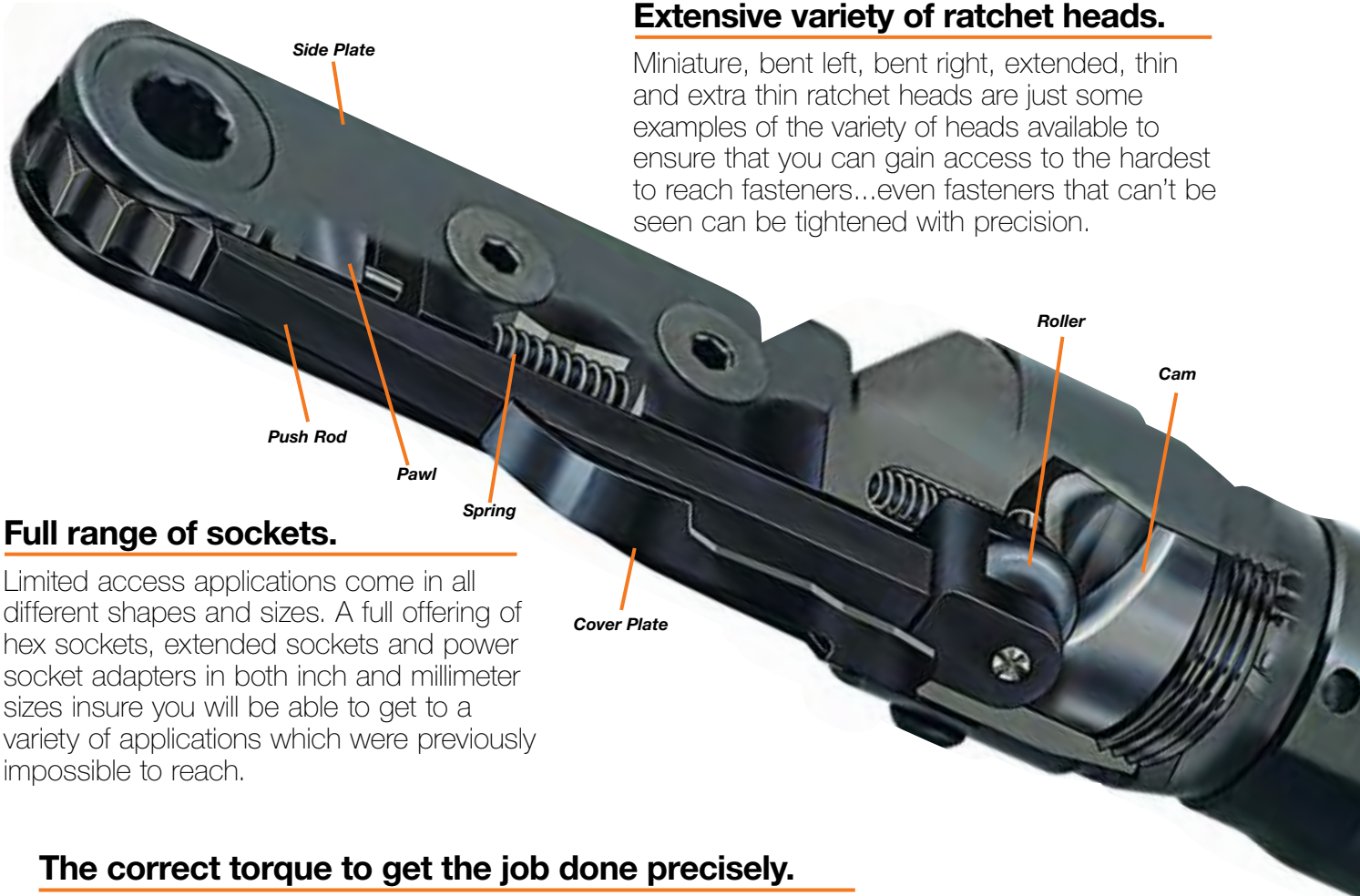

Full range of sockets.

Limited access applications come in all different shapes and sizes. A full offering of hex sockets, extended sockets and power socket adapters in both inch and millimeter sizes insure you will be able to get to a variety of applications which were previously impossible to reach.

The correct torque to get the job done precisely.

Cleco 24 and 34 series ratchet wrenches are available in sizes up to 50 Ft.Lbs. Several sizes of side plate widths and thicknesses are available to provide a wide range of torques without sacrificing size or durability.

Success in simplicity.

By using a single direction stall motor the Cleco 24 and 34 series ratchet wrenches eliminate components that traditionally add cost and decrease service life. With this tool you truly get what you pay for. A very economical and dependable solution for the hardest to reach fasteners. Need a reversible tool? No problem, simply flip the tool over.

Gears that have stood up to the test of time.

The key wear items in the ratchet head (gears, cams, and push rods) have remained unchanged from the previous H16 and H30 tools. Not only can you have confidence in their durability, you won't have to buy new replacement parts.



Improved motor for better performance.

Innovative low inertia motor design provides more usable power in a smaller package size. The end result is a more ergonomic handle for a more productive tool. The same successful motor is used on Cleco flush socket, crowfoot, hold-and-drive and standard Clecomatic clutch shut-off nutrunners.

Ergonomic grip for operator comfort.

Rubber coated motor housing helps isolate the operator from temperature changes.



Cleco®

Easy assembly/disassembly with a standard spanner wrench.

Hardened steel bearing plates resist wear and assures longer life.

Ratchet Wrenches

Stall Type

Cleco®

24 & 34 Series

Torque Range:
up to 68.3 Nm
up to 50.4 Ft. Lbs

- Stall type
- Non-Reversible



Cleco 24/34 Series Model Number Nomenclature

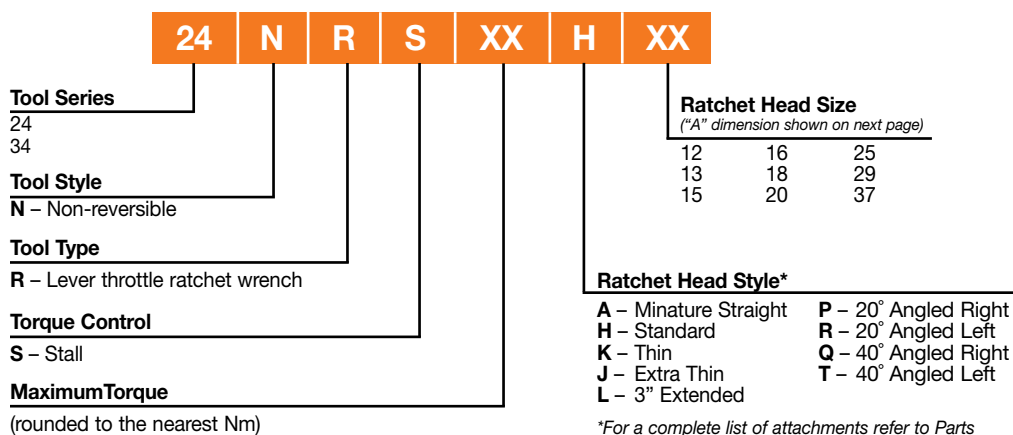

*For a complete list of attachments refer to Parts Manual #PL17-RA

Ratchet Wrenches

Stall Type

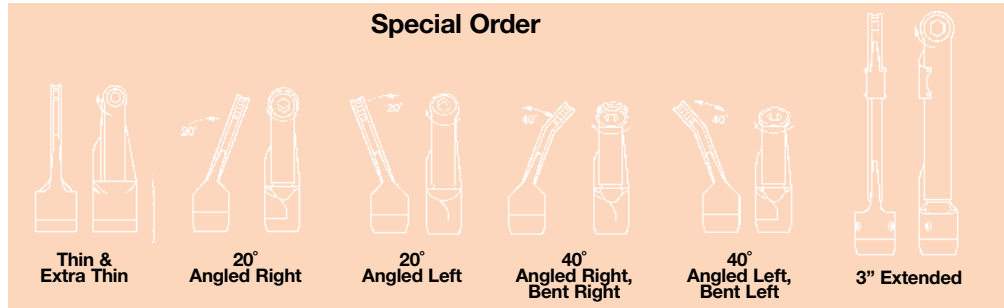
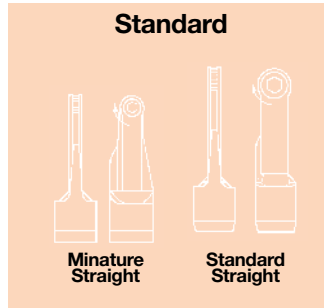

Other head types are available. Contact your Cooper Power Tools sales representative.

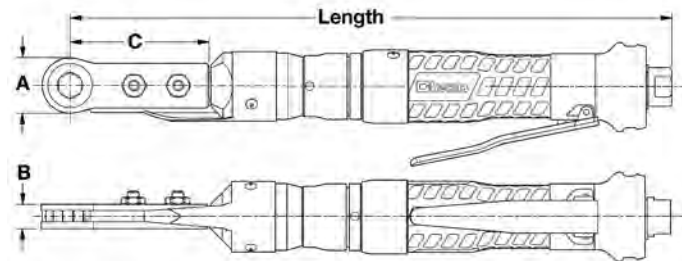

Model Number	Free Speed	Maximum Torque		Maximum Socket Size		"A"		"B"		"C"		Length		Weight	
	RPM	Ft. Lbs.	Nm	in.	mm	in.	mm	in.	mm	in.	mm	in.	mm	lbs.	kg
24 Series															
24NRS15A13	265	11.0	14.9	7/16	11	13/16	20.6	1/2	12.7	2.88	73.2	13.4	340	2.7	1.2
24NRS15A12	285	11.1	15.0	3/8	10	3/4	19.0	1/2	12.7	2.88	73.2	13.4	340	2.7	1.2
24NRS20H15	305	14.8	20.1	1/2	13	15/16	23.8	9/16	14.2	3.13	79.5	14.0	356	2.9	1.3
24NRS21H16	285	15.4	20.9	9/16	16	1	25.4	9/16	14.2	3.13	79.5	14.0	356	3.0	1.3
24NRS23A13	145	17.2	23.3	7/16	11	13/16	20.6	1/2	12.7	2.88	73.2	14.2	361	2.9	1.3
24NRS23H15	170	17.3	23.5	1/2	13	15/16	23.8	9/16	14.2	3.13	79.5	14.8	376	3.1	1.4
24NRS23H20	250	17.5	23.7	3/4	19	1 1/4	31.8	9/16	14.2	3.13	79.5	14.2	361	3.0	1.4
24NRS24H16	155	17.7	24.0	9/16	16	1	25.4	9/16	14.2	3.13	79.5	14.8	376	3.2	1.4
24NRS24H18	265	18.0	24.4	5/8	16	1 1/8	28.6	9/16	14.2	3.13	79.5	14.1	358	3.0	1.4
24NRS24A12	155	18.3	24.8	3/8	10	3/4	19.0	1/2	12.7	2.88	73.2	14.2	361	2.9	1.3
24NRS29H18	145	21.4	29.0	5/8	16	1 1/8	28.6	9/16	14.2	3.13	79.5	14.9	378	3.2	1.5
24NRS29H25	180	21.5	29.1	15/16	24	1 9/16	39.7	9/16	14.2	3.25	82.5	14.4	366	3.1	1.4
24NRS30H20	135	22.0	29.8	3/4	19	1 1/4	31.8	9/16	14.2	3.13	79.5	14.9	378	3.2	1.5
34 Series															
34NRS29H15	255	21.6	29.3	1/2	13	15/16	23.8	9/16	14.2	3.13	79.5	16.0	406	3.7	1.7
34NRS31H16	240	22.9	31.0	9/16	16	1	25.4	9/16	14.2	3.13	79.5	16.0	406	3.7	1.7
34NRS35H20	210	25.9	35.1	3/4	19	1 1/4	31.8	9/16	14.2	3.13	79.5	16.2	411	3.7	1.7
34NRS36H18	225	26.7	36.2	5/8	16	1 1/8	28.6	9/16	14.2	3.13	79.5	16.1	409	3.7	1.7
34NRS36H15	155	26.8	36.3	1/2	13	15/16	23.8	9/16	14.2	3.13	79.5	16.8	427	3.9	1.8
34NRS38H16	145	28.1	38.1	9/16	16	1	25.4	9/16	14.2	3.13	79.5	16.8	427	3.9	1.8
34NRS42H25	150	30.9	41.9	15/16	24	1 9/16	39.7	9/16	14.2	3.25	82.5	16.4	417	3.8	1.7
34NRS46H20	125	33.9	46.0	3/4	19	1 1/4	31.8	9/16	14.2	3.13	79.5	17.0	432	4.0	1.8
34NRS46H18	135	34.1	46.2	5/8	16	1 1/8	28.6	9/16	14.2	3.13	79.5	16.9	429	4.0	1.8
34NRS48H29	140	35.1	47.6	1 1/8	29	1 13/16	46.0	5/8	15.9	3.50	88.9	16.9	429	4.0	1.8
34NRS52H25	90	38.4	52.1	15/16	24	1 9/16	39.7	9/16	14.2	3.25	82.5	17.2	437	4.1	1.8
34NRS53H37	120	38.9	52.7	1 5/8	41	2 11/32	59.5	5/8	15.9	3.75	95.3	17.3	439	4.4	2.0
34NRS63H29	85	46.7	63.3	1 1/8	29	1 13/16	46.0	5/8	15.9	3.50	88.9	17.7	450	4.2	1.9
34NRS68H37	70	50.4	68.3	1 5/8	41	2 11/32	59.5	5/8	15.9	3.75	95.3	18.1	460	4.6	2.1

General:
 Air Inlet: 1/4" NPT
 Tool performance rated at 90 psi (620kPa) air pressure.

Standard Equipment:
 Suspension bail, hex socket

Socket Selection:
 See pages 45-47

Ratchet Wrenches

Clutch Type

Cleco®

H16, H30, 41 & 60 Series

Torque Range:
up to 415 Nm
up to 306 Ft. Lbs

- Clutch activated air shut-off (H16, H30 & 60 series)
Air shut-off (41 series)
- Non-Reversible



Model Number	Free Speed	Maximum Torque		Maximum Socket Size		"A"		"B"		"C"		Weight		Length	
	RPM	Ft. Lbs.	Nm	in.	mm	in.	mm	in.	mm	in.	mm	lbs.	kg	in.	mm
H16NDR09H15	130	10.0	13.5	1/2	13	15/16	23.8	9/16	14.2	3.13	79.5	4.3	2.0	18.9	480
H30NDR08H15	120	12.0	16.2	1/2	13	15/16	23.8	9/16	14.2	3.13	79.5	4.9	2.2	20.6	523
41NDR236H15	360	23.0	31.1	1/2	13	15/16	23.8	9/16	14.2	3.13	79.5	5.7	2.6	17.7	449
41NDR172H15	265	32.0	43.3	1/2	13	15/16	23.8	9/16	14.2	3.13	79.5	5.7	2.6	17.7	449
41NDR130H15	200	42.0	56.9	1/2	13	15/16	23.8	9/16	14.2	3.13	79.5	6.1	2.8	18.8	478
H30NDR08H16	110	13.0	17.6	5/8	16	1	25.4	9/16	14.2	3.13	79.5	4.9	2.2	20.6	523
41NDR236H16	335	25.0	33.8	5/8	16	1	25.4	9/16	14.2	3.13	79.5	5.7	2.6	17.7	449
41NDR172H16	245	34.0	46.0	5/8	16	1	25.4	9/16	14.2	3.13	79.5	5.7	2.6	17.7	449
41NDR130H16	185	45.0	60.9	5/8	16	1	25.4	9/16	14.2	3.13	79.5	6.1	2.8	18.8	478
H30NDR08H18	105	18.0	24.3	5/8	16	1 1/8	28.6	9/16	14.2	3.13	79.5	4.9	2.2	20.7	526
41NDR236H18	315	29.0	39.2	5/8	16	1 1/8	28.6	9/16	14.2	3.13	79.5	5.8	2.6	17.7	449
41NDR130H18	170	52.0*	70.4	5/8	16	1 1/8	28.6	9/16	14.2	3.13	79.5	6.1	2.8	18.8	478
H16NDR09H20	110	16.0	21.6	3/4	19	1 1/4	31.8	9/16	14.2	3.13	79.5	4.4	2.0	19.1	485
H30NDR08H20	100	19.0	25.7	3/4	19	1 1/4	31.8	9/16	14.2	3.13	79.5	4.9	2.2	20.8	528
41NDR172H20	215	42.0	56.9	3/4	19	1 1/4	31.8	9/16	14.2	3.13	79.5	5.8	2.6	17.7	449
41NDR130H20	160	56.0*	75.8	3/4	19	1 1/4	31.8	9/16	14.2	3.13	79.5	6.1	2.8	18.8	478
60NDR092HD24	95	122.0	165.3	3/4	19	1 1/2	38.1	7/8	22.4	6.19	157.2	16.9	7.7	27.4	697
H30NDR08H25	70	22.0	29.8	15/16	24	1 9/16	39.7	9/16	14.2	3.25	82.5	5.0	2.3	21.0	533
41NDR172H25	155	53.0*	71.8	15/16	24	1 9/16	39.7	9/16	14.2	3.25	82.5	5.8	2.6	17.8	452
41NDR130H25	115	70.0*	94.8	15/16	24	1 9/16	39.7	9/16	14.2	3.25	82.5	6.1	2.8	18.9	481
60NDR092HD40	60	212.0	287.2	1 1/2	38	2 1/2	63.5	7/8	22.4	6.69	169.9	17.2	7.8	28.4	722
60NDR092HD48	50	252.0	341.4	1 15/16	49	3	76.2	1	25.4	6.94	176.3	17.7	8.0	28.9	735
60NDR092HD56	40	306.0	415.0	2-3/8	60	3 1/2	88.9	1	25.4	7.25	184.2	18.0	8.2	29.5	749

General:
Air Inlet: 1/4" NPT (H16, H30),
3/8" NPT (41), 1/2" NPT (60)
Tool performance rated at 90 psi (620kPa) air pressure.

Standard Equipment:
H16, H30: Suspension bail, hex socket
41: Hex socket
60: Hex socket, reaction bar collar
(1/2" hex opening for reaction bar)

Socket Selection:
See pages 45-47
*WARNING: these terminations are not recommended for applications over 50 Ft. Lbs. (68 Nm) torque.

Ratchet Wrenches

Hex Socket Selection Charts

Standard Length 24, 34, H16, H30, 41 Series *(No additional cost)*

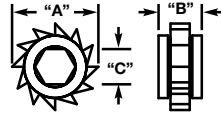

Termination		12	13	15	16	18	20	25	29	37
"A"		3/4	13/16	15/16	1	1 1/8	1 1/4	1 9/16	1 13/16	2 11/32
"B"		1/2	1/2	9/16	9/16	9/16	9/16	9/16	5/8	5/8
"C"		Socket Part Numbers								
Hex*										
1/4"	S.H.	28000	28020PT	28048	28075PT					
1/4"	D.H.	28001	28021PT	28051PT						
9/32"	S.H.	28012PT								
5/16"	S.H.	28002PT	28022	28040PT	28056		28101	28135		
5/16"	D.H.	28003	28023	28052PT	28078		28124PT			30434
11/32"	S.H.	28004PT	28024PT		28074PT	28097PT	28102			
11/32"	D.H.	28005								
3/8"	S.H.	28006	28026PT	28041	28057PT	28094PT	28160PT			
3/8"	D.H.	28007PT	28027	28042PT	28058PT		28123	28166PT		
7/16"	S.H.	28009PT†	28029PT	28043PT	28060PT	28081PT	28105PT	28136PT	28192PT	30418PT
7/16"	D.H.	28010†	28030	28044PT	28061PT	28082PT	28106PT	28137		30435PT
1/2"	S.H.		28031PT†	28046PT	28063	28083PT	28108	28139	28170	30423
1/2"	D.H.		28032†	28047	28064	28084PT	28109	28140PT		
9/16"	S.H.				28066	28087	28111	28141	28171	30432
9/16"	D.H.				28067PT	28088	28112	28142PT	28189PT	
5/8"	S.H.				28069PT†	28090PT	28115	28144PT	28172	
5/8"	D.H.				28070†	28091	28116PT	28145	28190PT	30431PT
11/16"	S.H.						28118PT	28146PT	28173	30433
11/16"	D.H.						28119	28147		
3/4"	S.H.						28121	28148PT	28174	30429PT
3/4"	D.H.						28122PT	28149PT	28191PT	
13/16"	S.H.							28150	28175	
13/16"	D.H.							28151PT		
7/8"	S.H.							28154	28176PT	30427PT
7/8"	D.H.							28155PT	28177	
15/16"	S.H.							28156PT	28179	30430
15/16"	D.H.							28157PT	28180PT	30434
1"	S.H.								28181	30428PT
1"	D.H.								28182PT	
1-1/16"	S.H.								28183PT	30436
1-1/16"	D.H.								28184	
1-1/8"	S.H.								28185PT	30417PT
1-1/8"	D.H.								28187	
1-3/16"	S.H.									30425PT
1-1/4"	S.H.									30419PT
1-5/16"	S.H.									30426
1-7/16"	S.H.									30420
1-1/2"	S.H.									30421
1-1/2"	D.H.									30437
1-5/8"	S.H.									30422PT
6 mm	S.H.	28016PT	28033PT	28055PT						
7 mm	S.H.	28017PT	28034PT	530440			28126	28163		
8 mm	S.H.	28002PT	28022	28040PT	28056					
8 mm	D.H.	28003	28023		28078					
9 mm	S.H.				28071					
9 mm	D.H.		28037							
10 mm	S.H.	28008PT	28028	28054PT	28059PT	28093	28104PT	28164		
11 mm	S.H.	28009PT†	28029PT	28043PT	28060PT	28081PT		28136PT	530460	
12 mm	S.H.			28045	28062		28107	28138PT		
13 mm	S.H.		28036	28053	28077PT	28096PT	28125PT	28161PT	530461	
14 mm	S.H.			530441	28065PT	28086PT	28110PT	28159		
15 mm	S.H.				28068PT	28089	28113	28143	530462	532431
15 mm	D.H.				28080PT	28095PT				
16 mm	S.H.				28100PT	28099		28167		
17 mm	S.H.				543126	28092PT	28117	28158	28193PT	
18 mm	S.H.						28120	28165PT		30439PT
19 mm	S.H.						28121	28148PT	28174	30429PT
19 mm	D.H.						28122PT	28149PT	28191PT	
21 mm	S.H.							28152		
22 mm	S.H.							28162		
23 mm	S.H.								28178PT	
24 mm	S.H.							28168		
29 mm	S.H.								28188PT	

* S.H. = Single Hex; D.H. = Double Hex

† FRAGILE: For light duty operations only.

Ratchet Wrenches

Hex Socket Selection Charts

Standard Length

60 Series (No additional cost)

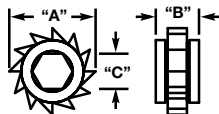

Termination	24	32	40	48	56
"A"	1 1/2	2	2 1/2	3	3 1/2
"B"	7/8	7/8	7/8	1	1
"C"	Hex*	Socket Part Numbers			
1/2"	S.H.	29015	29053	29121	
1/2"	D.H.	29016			
9/16"	S.H.	29017			
9/16"	D.H.	29018			
5/8"	S.H.	29019	29035		
5/8"	D.H.	29020			
11/16"	S.H.	29021	29037	507159	
11/16"	D.H.	29038			
3/4"	S.H.	29023	29039	507157	29115
3/4"	D.H.	29024			
13/16"	S.H.	29041		29055	
13/16"	D.H.	29042			
7/8"	S.H.	29043	29057	29150	
7/8"	D.H.	29044			
15/16"	S.H.	29045	29059	29111	29122
15/16"	D.H.	29046		29112	
1"	S.H.	29047	29061	29116	29147
1"	D.H.	29048			
1 1/16"	S.H.	29049	29063	29114	29146
1 1/16"	D.H.	29050			
1 1/8"	S.H.	29051†	29065	29090	29148
1 1/8"	D.H.	29052†		29066	
1 3/16"	S.H.	29075		29118	29153
1 1/4"	S.H.	29067			
1 1/4"	D.H.	29068		29093	
1 5/16"	S.H.	29069	29094	523736	
1 5/16"	D.H.	29070		29095	
1 3/8"	S.H.	29117			29145
1 7/16"	S.H.	29071		29096	29123
1 7/16"	D.H.	29072			
1 1/2"	S.H.	29073		29098	
1 1/2"	D.H.	29074			
1 9/16"	S.H.	29152			
1 5/8"	S.H.	29100			29127
1 5/8"	D.H.	29101			29128
1 11/16"	S.H.	29129			
1 11/16"	D.H.	29103			
1 3/4"	S.H.	29108			
1 13/16"	S.H.	29104			
1 13/16"	D.H.	29132			
1 7/8"	S.H.	29106		29133	
1 15/16"	S.H.	29110†		29135	
2"	S.H.	29137			
2 1/16"	S.H.	29138			
2 1/16"	D.H.	29139			
2 3/16"	S.H.	29141			
2 1/4"	S.H.	29143†			
2 3/8"	S.H.	29143†			
15 mm	S.H.	29028	507135	507161	
18 mm	S.H.	29027			
21 mm	S.H.	29029	507136		
22 mm	S.H.	507134			
24 mm	S.H.	507132	507160	29119	
26 mm	S.H.	507133		507157	
29 mm	S.H.	507134			
30 mm	S.H.	507137		507162	
36 mm	S.H.	29079			523738

Power Socket Adapters

Adapts grooved sockets to square drive. Use with conventional square drive socket. (additional cost)

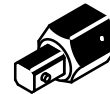

Part Number	Hex Size	Square Drive	Overall Length
A-312	3/8"	3/8"	0.94"
A-314	7/16"	3/8"	0.94"
A-514	7/16"	1/2"	1.09"
A-516	1/2"	1/2"	1.16"
A-518	9/16"	1/2"	1.16"
A-520	5/8"	1/2"	1.13"
A-524	3/4"	1/2"	1.13"

Extended Length 24, 34, H16, H30, 41 Series

(Additional cost. Provides CCW tightening.)

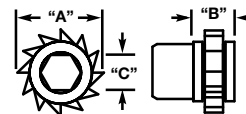

Termination	12	13	15	16	18	20	25	29
"A"	3/4	13/16	15/16	1	1 1/8	1 1/4	1 9/16	1 13/16
"B"	1/2	1/2	9/16	9/16	9/16	9/16	9/16	5/8
"C"	Hex*	Ext.	Socket Part Numbers					
5/16"	S.H.	1/2"	501060					
3/8"	S.H.	1/4"	20966					
3/8"	D.H.	1/4"	28652PT					
7/16"	S.H.	1/4"	28650PT					
7/16"	S.H.	1/2"	501056					
1/2"	S.H.	1/4"	28645PT					
1/2"	S.H.	1/2"	501059					
1/2"	S.H.	5/8"	501061					
1/2"	S.H.	3/4"	501054					
9/16"	S.H.	3/8"	501051					
9/16"	S.H.	1/2"	501053					
9/16"	S.H.	7/8"	28649PT					
5/8"	S.H.	3/8"	28648PT†					
1 3/16"	S.H.	3/4"	501062					
13 mm	S.H.	1/2"	501063					

Double Extended 24, 34, H16, H30, 41 Series

(Additional cost)

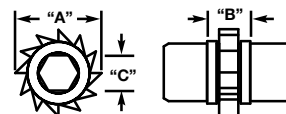

Termination	12	13	15	16	18	20	29	
"A"	3/4	13/16	15/16	1	1 1/8	1 1/4	1 13/16	
"B"	1/2	1/2	9/16	9/16	9/16	9/16	5/8	
"C"	Hex*	Ext.	Socket Part Numbers					
5/16"	S.H.	1/4"	10642					
5/16"	D.H.	1/2"	501222					
3/8"	S.H.	3/8"	501225					
7/16"	S.H.	1/4"	18950					
7/16"	S.H.	1/2"	28787PT					
1/2"	D.H.	1/8"	28654					
1/2"	S.H.	1/4"	28663					
1/2"	S.H.	7/16"	501221					
1/2"	D.H.	1/2"	28660PT					
9/16"	S.H.	1/8"	28659PT					
9/16"	D.H.	1/8"	28655PT					
9/16"	S.H.	1/4"	28656PT					
9/16"	D.H.	3/8"	28657PT					
9/16"	S.H.	1/2"	28791					501230
9/16"	D.H.	1/2"	501231					
11/16"	S.H.	1/2"	28793					
3/4"	D.H.	3/8"	28797†					
3/4"	S.H.	3/4"	28661					
13 mm	S.H.	1/4"	501229					530024
13 mm	S.H.	3/8"	501226					
13 mm	S.H.	1/2"	530741					530028
13 mm	S.H.	3/4"	530742					531201
15 mm	S.H.	1/4"	501227					530025
15 mm	S.H.	3/8"	501228					530001
15 mm	S.H.	1/2"	530026					530003
15 mm	S.H.	3/4"	531200					530004

* S.H. = Single Hex; D.H. = Double Hex

† FRAGILE: For light duty operations only.

Ratchet Wrenches

Hex Socket Selection Charts

Extended Length H16, H30, 41 Series

(Additional cost. Provides CW tightening.)

Termination	12	13	15	16	18	20	25	29
"A"	3/4	13/16	15/16	1	1 1/8	1 1/4	1 9/16	1 13/16
"B"	1/2	1/2	9/16	9/16	9/16	9/16	9/16	5/8
"C"	Socket Part Numbers							
1/4" S.H. 1/4"	28300PT							
1/4" D.H. 3/8"	508406							
1.4" D.H. 1/2"	28314							
5/16" S.H. 1/4"	28301 28331 28353PT							
5/16" D.H. 1/4"	28316PT 28387PT							
5/16" S.H. 3/8"	28302PT 28333 28338							
5/16" D.H. 3/8"	28335 28352							
5/16" S.H. 1/2"	28320PT 28350PT 516546							
5/16" S.H. 3/4"	28392PT							
5/16" S.H. 7/8"	28313PT							
11/32" S.H. 1/4"	28303							
11/32" S.H. 1/2"	28336PT							
11/32" S.H. 3/4"	28304PT							
3/8" D.H. 1/8"	28347PT 28384PT							
3/8" S.H. 1/4"	28305PT 28323 28339PT 28354PT							
3/8" D.H. 1/4"	28317 28386PT							
3/8" S.H. 3/8"	28306 28324 28385PT 28407PT							
3/8" S.H. 1/2"	28307 28355PT 28441PT							
3/8" D.H. 1/2"	28308							
3/8" S.H. 5/8"	28319							
3/8" D.H. 5/8"	28325PT							
3/8" S.H. 3/4"	28309PT 28356PT 28408PT							
3/8" D.H. 3/4"	28389							
3/8" S.H. 7/8"	28326							
3/8" S.H. 1"	28340							
3/8" D.H. 1"	28351							
7/16" S.H. 1/8"	508399							
7/16" S.H. 1/4"	28310PT† 28327 28341 28357 28439PT							
7/16" D.H. 1/4"	28334PT 28342 28358							
7/16" S.H. 3/8"	28311† 28328PT 28359 28409							
7/16" S.H. 1/2"	28312PT 28329 28343PT 28360 28405 28410PT							
7/16" S.H. 5/8"	28344PT							
7/16" D.H. 5/8"	508397							
7/16" S.H. 3/4"	28361PT 28411							
7/16" S.H. 7/8"	28362PT							
7/16" D.H. 1"	508398							
1/2" S.H. 1/8"	508400 28363PT							
1/2" D.H. 1/8"	508404							
1/2" S.H. 1/4"	28345PT 28364PT 28406PT 28412PT							
1/2" D.H. 1/4"	28348PT 28365							
1/2" S.H. 3/8"	28330 28366PT 28413PT 28465PT 28469PT							
1/2" S.H. 1/2"	28367PT 28402PT 28414PT 28478							
1/2" D.H. 1/2"	28349PT 28368							
1/2" S.H. 5/8"	28369PT 28401PT 28466PT							
1/2" D.H. 5/8"	28346 28437							
1/2" S.H. 3/4"	28370PT 28404PT 28415PT							
1/2" S.H. 7/8"	28416PT							
1/2" S.H. 1"	28371PT							
9/16" S.H. 1/8"	28372PT							
9/16" S.H. 1/4"	28373 28395PT 28418PT 28471PT							
9/16" D.H. 1/4"	28374							
9/16" S.H. 3/8"	28375PT† 28396PT							
9/16" D.H. 3/8"	28376† 28440							
9/16" S.H. 1/2"	28377† 28403 28419 28463PT							
9/16" D.H. 1/2"	28378PT† 28420 517065							
9/16" S.H. 5/8"	28379PT† 28397PT							
9/16" S.H. 3/4"	28393PT† 28421 28468PT							
9/16" D.H. 3/4"	28444PT 28464PT							
9/16" S.H. 7/8"	28380PT†							
9/16" D.H. 7/8"	516547							
9/16" S.H. 1"	517061							
5/8" S.H. 1/8"	28422							
5/8" S.H. 1/4"	28381PT† 28452PT 28479PT							
5/8" D.H. 1/4"	28423							
5/8" S.H. 3/8"	28382PT†							
5/8" S.H. 1/2"	28388PT† 28399PT 28424PT 28453PT							
5/8" S.H. 5/8"	28454PT							
5/8" S.H. 3/4"	28400PT 28426PT 28455							

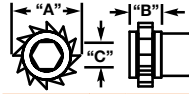

Termination	12	13	15	16	18	20	25	29
"A"	3/4	13/16	15/16	1	1 1/8	1 1/4	1 9/16	1 13/16
"B"	1/2	1/2	9/16	9/16	9/16	9/16	9/16	5/8
"C"	Socket Part Numbers							
5/8" D.H. 1"	28428PT							
11/16" S.H. 1/4"	28438PT							
11/16" D.H. 1/4"	28430PT							
11/16" S.H. 3/8"	28431PT 28456PT							
11/16" S.H. 1/2"	28432PT 514830							
11/16" S.H. 1"	517062							
3/4" S.H. 1/4"	28433PT†							
3/4" S.H. 3/8"	28458PT							
3/4" S.H. 1/2"	28434PT							
3/4" S.H. 3/4"	28435PT 28459 28476							
3/4" S.H. 1"	28436 28470PT							
7/8" S.H. 1/4"	517063							
7/8" D.H. 5/8"	28461PT							
7/8" S.H. 1"	28462PT							
15/16" S.H. 1/2"	28474							
1" S.H. 1/2"	28472PT							
1-1/8" S.H. 1/2"	28477							
6 MM S.H. 1/4"	530453							
6 MM S.H. 1/2"	28321							
7 MM S.H. 1/4"	530454 516554							
7 MM S.H. 1/2"	28322 516553							
8 MM S.H. 1/4"	530455 516558							
8 MM S.H. 1/2"	530450 516555							
10 MM S.H. 1/4"	530456 516559							
10 MM S.H. 3/8"	533472 28390PT							
10 MM S.H. 1/2"	530451 508405 516556							
11 MM S.H. 1/4"	530457 530515							
11 MM S.H. 1/2"	530452 516557							
12 MM S.H. 1.2"	530520							
13 MM S.H. 1/8"	28391PT							
13 MM S.H. 1/4"	28394PT							
13 MM S.H. 3/8"	525137							
13 MM S.H. 1/2"	533471 516552							
13 MM S.H. 1"	530519							
14 MM S.H. 1/4"	530516 28449PT							
14 MM S.H. 1/2"	28417PT 517070							
15 MM S.H. 1/4"	530517 28450PT 517067							
15 MM D.H. 1/4"	530518							
15 MM S.H. 3/8"	28451PT							
15 MM D.H. 3/8"	28630							
15 MM S.H. 1/2"	516551 28447PT 517066							
15 MM D.H. 1/2"	516550							
15 MM S.H. 3/4"	28446PT							
17 MM S.H. 1/4"	28448PT							
17 MM S.H. 3/8"	517068 514831							
17 MM S.H. 1/2"	28429PT 517060 514829							
17 MM D.H. 1"	28445PT							
18 MM S.H. 3/4"	543176 517069							

Grooved 24, 34, H16, H30, 41 Series

Use with Power Socket Adapters (Additional cost)

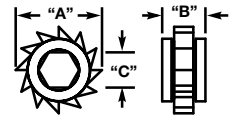

Termination	12	13	15	16	20	25	29
"A"	3/4	13/16	15/16	1	1 1/4	1 9/16	1 13/16
"B"	1/2	1/2	9/16	9/16	9/16	9/16	5/8
"C"	Socket Part Numbers						
1/4"	28741						
5/16"	28740						
3/8"	28739PT						
7/16"	28742PT 504772 28745PT 28750 28751PT 25737						
1/2"	28746 28748PT 28752PT 28766PT						
9/16"	28753PT 28768PT						
5/8"	28754PT						
3/4"	28755 28767PT						

* S.H. = Single Hex; D.H. = Double Hex

† FRAGILE: For light duty operations only.

Pulse Nutrunners

Cleco®

**Durable.
Economical.
Low Maintenance.**

Unbeatable Performance

We are constantly improving our products to guarantee you ideal productivity. The new Cleco H-Series pulse tools combine legendary durability with unmatched repeatability so that you will be able to complete every joint quickly and reliably.

■ Broad Tool Selection

With a variety of shut-off and non-shut-off pulse tools to choose from you are sure to find just the right Cleco pulse tool for the job.



High Precision Shut-Off

mechanism ranges close to the characteristics of an electric tool at a tolerance of +/- 10% at Six Sigma.

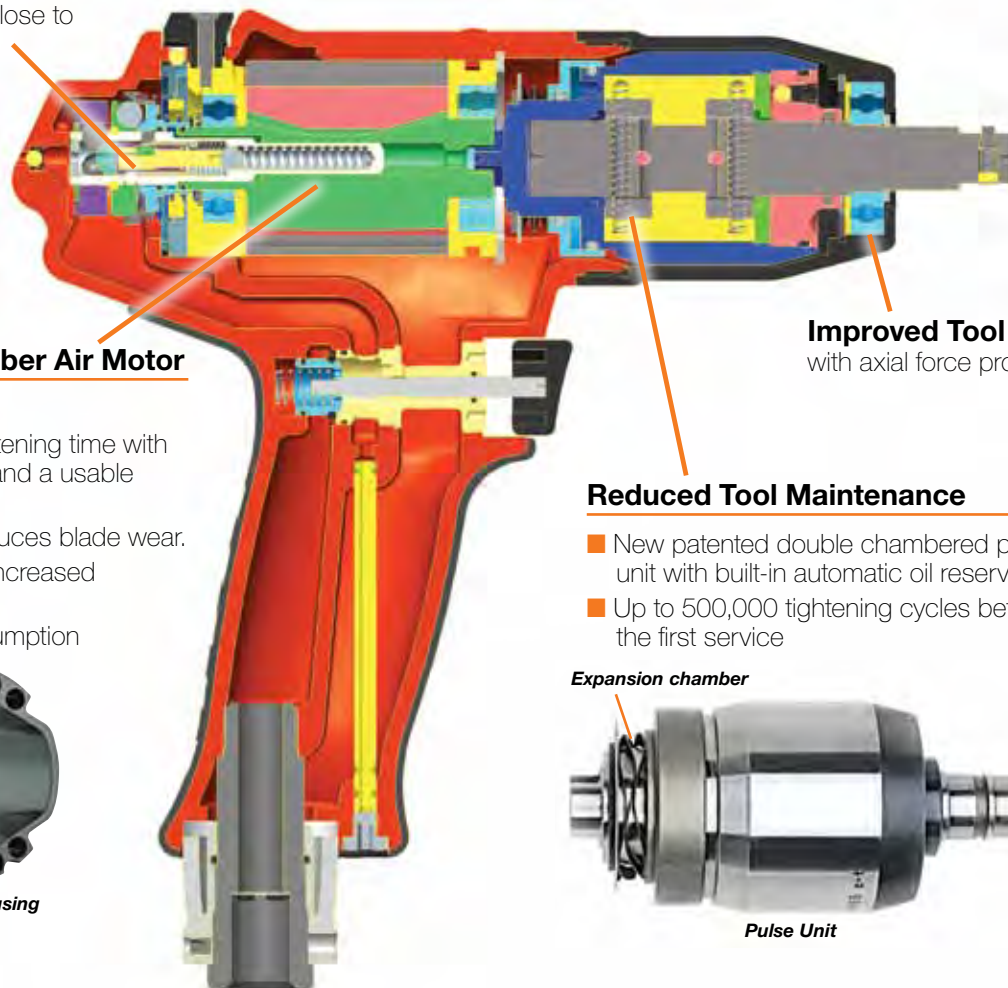

Efficient 3-Chamber Air Motor

- Speed governor
- Reduces your tightening time with increased torque and a usable high-end dynamic.
- Unique design reduces blade wear.
- Less vibration for increased user comfort
- Reduced air consumption



3-Chamber Motor Housing

Improved Tool End
with axial force protection

Reduced Tool Maintenance

- New patented double chambered pulse unit with built-in automatic oil reserve
- Up to 500,000 tightening cycles before the first service

Expansion chamber



Pulse Unit

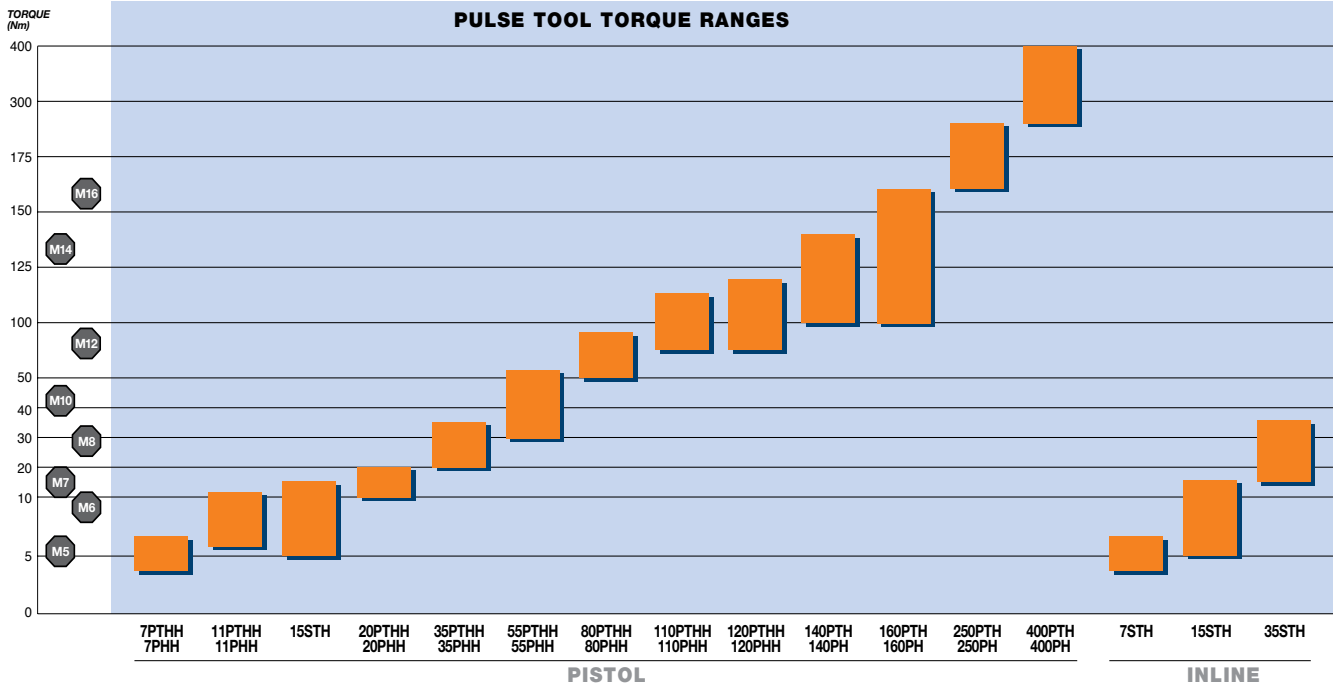

Low Noise Levels

Noise levels of these tools are well below standard air tools for an operator-friendly environment. There is no loud metallic hammering under load.

Ships Ready For Error Proofing

- Works with existing TVP torque verifier
- Located near air inlet to maximize ergonomics



Standard air signal indicating tool shutoff for use with Cleco TVP Error Proofing System.

Easy Set-Up

- Insert 2mm hex into rear port of tool
- Positive stops in both directions to prevent loss and/or damage



Adjustable Motor Speed

- Easily adjustable motor speed to insure accuracy on hard joints
- Can be locked in place to prevent accidental adjustment



Pulse Nutrunners

Hydraulic Pulse Shut-Off & Non Shut-Off

Cleco®

H-Series PTH

Torque Range: 4 - 120 Nm
3.0 - 88.8 Ft. Lbs
Bolt Size: M5 - M12
#10 - 1/2"

- Inertia shut-off
- Motor governor equipped
- External torque adjustment
- External speed control
- Torque signal port
- Adjustable pulse unit volume simplifies maintenance
- Market-leading repeatability
- Reversible
- Oilless blades



C-Series PTHC & PTHFC

Torque Range: 100 - 400 Nm
74 - 295 Ft. Lbs
Bolt Size: M12 - M20
1/2" - 3/4"

- Hydraulic pulse shut-off
- Motor governor equipped
- External torque adjustment
- External speed control
- Reversible
- Oilless blades
- Torque signal port



C-Series STHFC & STHF

Torque Range: 2.6 - 35 Nm
1.9 - 26 Ft. Lbs
Bolt Size: M5 - M8
#10 - 3/8"

- Hydraulic pulse shut-off
- Motor governor equipped
- External torque adjustment
- External speed control
- Reversible
- Oilless blades
- Torque signal port



Model Number Nomenclature

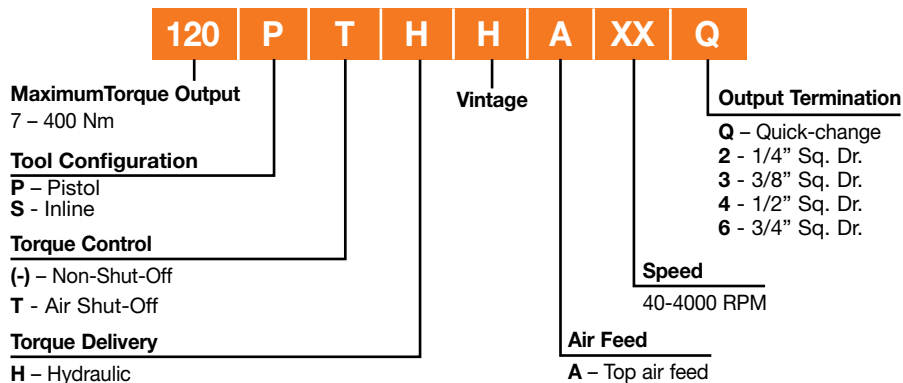

Pulse Nutrunners

Hydraulic Pulse Shut-Off

Model Number	Drive Type	Torque Range		Free Speed	Weight		Air Consumption		
		Ft.Lbs.	Nm	RPM	lbs.	kg	NPT	Hose I.D.	SCFM
H-Series – Pistol Grip – Shut-Off Models									
7PTHH352	1/4" Sq.Dr.	3.0-5.1	4-7	3500	1.74	0.79	1/4"	3/8"	7.06
7PTHH35Q	1/4" QC	3.0-5.1	4-7	3500	1.74	0.79	1/4"	3/8"	7.06
11PTHH352	1/4" Sq.Dr.	4.4-8.1	6-11	3500	1.81	0.82	1/4"	3/8"	7.06
11PTHH35Q	1/4" QC	4.4-8.1	6-11	3500	1.87	0.85	1/4"	3/8"	7.06
11PTHH353*	3/8" Sq.Dr.	4.4-8.1	6-11	3500	1.83	0.83	1/4"	3/8"	7.06
20PTHH40Q	1/4" QC	7.4-14.7	10-20	4000	1.92	0.87	1/4"	1/2"	8.7
20PTHH40Q*	3/8" Sq.Dr.	7.4-14.7	10-20	4000	1.90	0.86	1/4"	1/2"	8.7
35PTHH40Q	1/4" QC	14.8-25.8	20-35	4000	2.31	1.05	1/4"	1/2"	15.9
35PTHH40Q*	3/8" Sq.Dr.	14.8-25.8	20-35	4000	2.31	1.05	1/4"	3/8"	15.9
55PTHH40Q*	3/8" Sq.Dr.	22.1-40.5	30-55	4000	2.54	1.15	1/4"	3/8"	15.9
80PTHH35Q	7/16" QC	36.9-59.0	50-80	3500	3.20	1.45	1/4"	3/8"	19.4
80PTHH354	1/2" Sq.Dr.	36.9-59.0	50-80	3500	3.10	1.40	1/4"	3/8"	19.4
110PTHH30Q	7/16" QC	55.3-81.1	75-110	3000	3.75	1.70	3/8"	1/2"	19.4
120PTHH304	1/2" Sq.Dr.	55.3-88.8	75-120	3000	3.75	1.70	3/8"	1/2"	19.4
C-Series – Pistol Grip – Shut-Off Models									
140PTHFC25Q	7/16" QC	74-103	100-140	2500	5.7	2.6	3/8"	1/2"	25.4
160PTHFC256	3/4" Sq.Dr.	74-118	100-160	2500	5.7	2.6	3/8"	1/2"	25.4
C-Series – Pistol Grip – Shut-Off Models – Trigger Throttle									
250PTHFC226	3/4" Sq.Dr.	118-184	160-250	2200	8.8	4.0	3/8"	1/2"	33.5
400PTHFC206	3/4" Sq.Dr.	185-295	250-400	2000	11.7	5.3	3/8"	1/2"	33.5
In-Line – Push-to-Start									
7STHFA55Q	1/4" QC	1.9-4.9	2.6-6.6	5500	1.8	0.83	1/8"		7.0
35STHFA40Q	7/16" QC	12-26	15-35	4000	3.1	1.4	1/4"	3/8"	15.9
35STHFA404	1/2" Sq.Dr.	12-26	15-35	4000	2.9	1.3	1/4"	3/8"	15.9
C-Series – In-Line – Lever									
7STHFC55Q	1/4" QC	1.9-4.9	2.6-6.6	5500	2.1	0.93	1/8"		7.0
15STHFC40Q	1/4" QC	3.6-11	5.0-15	4000	2.4	1.1	1/4"	3/8"	16.5
35STHFC40Q	7/16" QC	12-26	15-35	4000	3.3	1.5	1/4"	3/8"	15.9
35STHFC404	1/2" Sq.Dr.	12-26	15-35	4000	3.3	1.5	1/4"	3/8"	15.9
15STHC40Q	1/4" QC	3.6-11	5.0-15	3000	2.4	1.1	1/4"	3/8"	16.5

PTHHA=Top Air Inlet

(*) 7/16" Quick Change Chuck available separately as an accessory

Standard Equipment:

Suspension bail and torque adjusting wrench.
Torque signal port (pistol grip models only)

Optional Equipment:

Additional accessories: Page 53

General:

Tool performance rated @ 87 psi (6 bar) air pressure.



Pulse Nutrunners

Hydraulic Pulse Non Shut-Off

Cleco®

H-Series PH Non-Shut-Off

Torque Range: 4 - 120 Nm
2.9 - 88.5 Ft. Lbs
Bolt Size: M5 - M12
#10 - 1/2"

- External speed control
- Reversible
- Oilless blades 



55PHHA403



55PHH403

	Model Number	Drive Type	Torque Range		Free Speed RPM	Weight		Air Consumption		
			Ft.Lbs.	Nm		lbs.	kg	NPT	Hose I.D.	SCFM
N O N S H U T O F F	H-Series – Pistol Grip – Non Shut-Off Models									
	7PHH602	1/4" Sq.Dr.	2.9-5.2	4-7	6000	1.70	0.77	1/4"	3/8"	8.7
	7PHH60Q	1/4" QC	2.9-5.2	4-7	6000	1.74	0.79	1/4"	3/8"	8.7
	11PHH653*	3/8" Sq.Dr.	4.4-8.1	6-11	6500	1.74	0.79	1/4"	3/8"	10.5
	11PHH652	1/4" Sq.Dr.	4.4-8.1	6-11	6500	1.72	0.78	1/4"	3/8"	10.5
	11PHH65Q	1/4" QC	4.4-8.1	6-11	6500	1.76	0.80	1/4"	3/8"	10.5
	20PHH753*	3/8" Sq.Dr.	7.4-14.7	10-20	7500	1.85	0.84	1/4"	3/8"	17.3
	20PHH75Q	1/4" QC	7.4-14.7	10-20	7500	1.90	0.86	1/4"	3/8"	17.3
	35PHH653*	3/8" Sq.Dr.	14.7-25.8	20-35	6500	2.25	1.02	1/4"	3/8"	19.4
	35PHH65Q	1/4" QC	14.7-25.8	20-35	6500	2.29	1.03	1/4"	3/8"	15.9
	55PHH603*	3/8" Sq.Dr.	22.1-40.5	30-55	6000	2.47	1.12	1/4"	3/8"	22.9
	80PHH604	1/2" Sq.Dr.	36.9-59.0	50-80	6000	3.09	1.40	1/4"	3/8"	26.5
80PHH60Q	7/16" QC	36.9-59.0	50-80	6000	3.13	1.41	1/4"	3/8"	26.5	
110PHH55Q	7/16" QC	55.3-81.1	75-110	5500	3.68	1.66	3/8"	1/2"	30.0	
120PHH554	1/2" Sq.Dr.	55.3-88.5	75-120	5500	3.64	1.65	3/8"	1/2"	30.0	
F	High Torque Pistol Grip – Non-Shut-Off Models									
	140PH45Q	7/16" QC	74-103	100-140	4500	5.7	2.6	3/8"	1/2"	31.7
	160PH456	3/4" Sq.Dr.	74-118	100-160	4500	5.7	2.6	3/8"	1/2"	31.7
	250PHF406	3/4" Sq.Dr.	118-184	160-250	4000	8.6	3.9	3/8"	1/2"	40.6
	400PHF356	3/4" Sq.Dr.	184-295	250-400	3500	11.5	5.2	3/8"	1/2"	42.3

PTHHA=Top Air Inlet

(*) 7/16" Quick Change Chuck available separately as an accessory.

For 7-75 Series Models, small handle can be ordered by substituting "S" for "L" in model number.

General:

Tool performance rated @ 87 psi (6 bar) air pressure.

Standard Equipment:

Suspension bail and torque adjusting wrench.

Optional Equipment:

Additional accessories: Page 53

Pulse Tool Accessories

Cleco

Rubber Tool Stand



Part Number	Tool Series
931041 (one piece)	D & H Series 7PTH – 120PTH
930119 (two pieces)	C Series 140/160PTH/PH/ 250PTH / 400PTH

TVP-100 Torque Signal Kit

Air signal to indicate shut-off.

Part Number	Tool Series
934918	PTH series pulse tools and vintage shut-off tools only

7/16" Quick Change Chuck Adapter

Part Number	Tool Series
935472	To convert 11/20/35/55PTHH/PTHHA/ PHH/PHHA to a Quick-Change chuck



Vibration Absorber

Part No.	Fits Model
935965	35/55PTHHA/PHHA
935966	80/110/120PTHHA/PHHA



Hydraulic Filler Unit

Filler Unit Complete	Part Number		Tool Series
	Filler Unit Only	Connector Only	
928477		932072	140/160 PTHC../ PH..
928473	928483	928485	250/400 PTHC../ PH.. 35 STH..
928475		931663	7 STH..
928474		928486	15 STH..

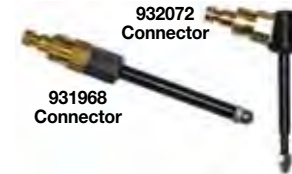

Reserve Oil Filling Set

Part No.
936695PT



Hydraulic Oil

Part Number	Container Size
539317	One Quart



Covers

Part No.	Fits Model
937442PT	Protective cover for 7/11/20PTHHA/7/11/20PHHA
937443PT	Protective cover for 35PTHHA/35PHHA
937444PT	Protective cover for 55PTHHA/55PHHA
937445PT	Protective cover for 80PTHHA/80PHHA
937446PT	Protective cover for 110/120PTHHA/110/120PHHA
937447PT	Protective cover for 7/11/20PTHH/7/11/20PHH
937448PT	Protective cover for 35PTHH/35PHH
937449PT	Protective cover for 55PTHH/55PHH
937450PT	Protective cover for 80PTHH/80PHH
937451PT	Protective cover for 110/120PTHH/110/120PHH



Impact Wrenches

Cleco®

Telescopic Impact Wrenches

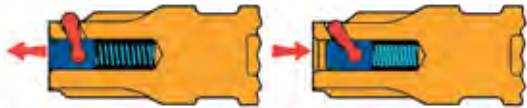

Positive Lock Socket Retainer

With the positive lock socket retainer, sockets snap on... and stay on until released. Offered on spline drives, the retainer can be serviced without disassembling the tool.

Exclusive through-bolt construction reduces replacement costs

Steel front end/motor housing/handle are clamped together by four high-strength steel bolts. This exclusive feature provides better tool performance, eliminates stripped threads and loose inserts in motor housing.



Positive oil-foam lubrication system reduces major cause of impact wrench maintenance.

Cleco impact wrenches feature a unique oil-foam bath that provides positive lubrication for the hammer, anvil and other working parts.



The system is designed so that if the impact mechanism runs low on 30 wt. oil, the tool will stop running, thus eliminating one of the major causes of impact wrench failure ... lack of lubrication. By simply refilling the oil reservoir, the tool can be returned to service. Other impact wrenches soon throw off grease; run dry causing extra wear that shortens tool life and increases maintenance cost.

Proven heavy-duty telescoping impact mechanism adds power...cuts weight...reduces shock to the operator.

The smooth-hitting Cleco telescopic impact mechanism has only three major parts - hammer, anvil and rotor... providing more power directly to the fastener. The hammer is splined to the inside of the motor, which then impacts directly on the anvil, delivering more power per blow.

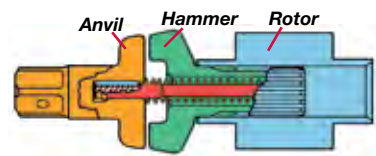

Other important features include:

- Comfortable grip handle
- Outside, inside triggers and pistol grip models
- Multiposition dead handle, and spade type "D" handle available
- Throttle can be feathered for speed control
- Simple face-type reversing valve simplifies maintenance
- Forged hammer and anvil for greater durability
- Rotor bearings and steel motor end plates fit either end of motor, reducing spare parts inventory and repair time.

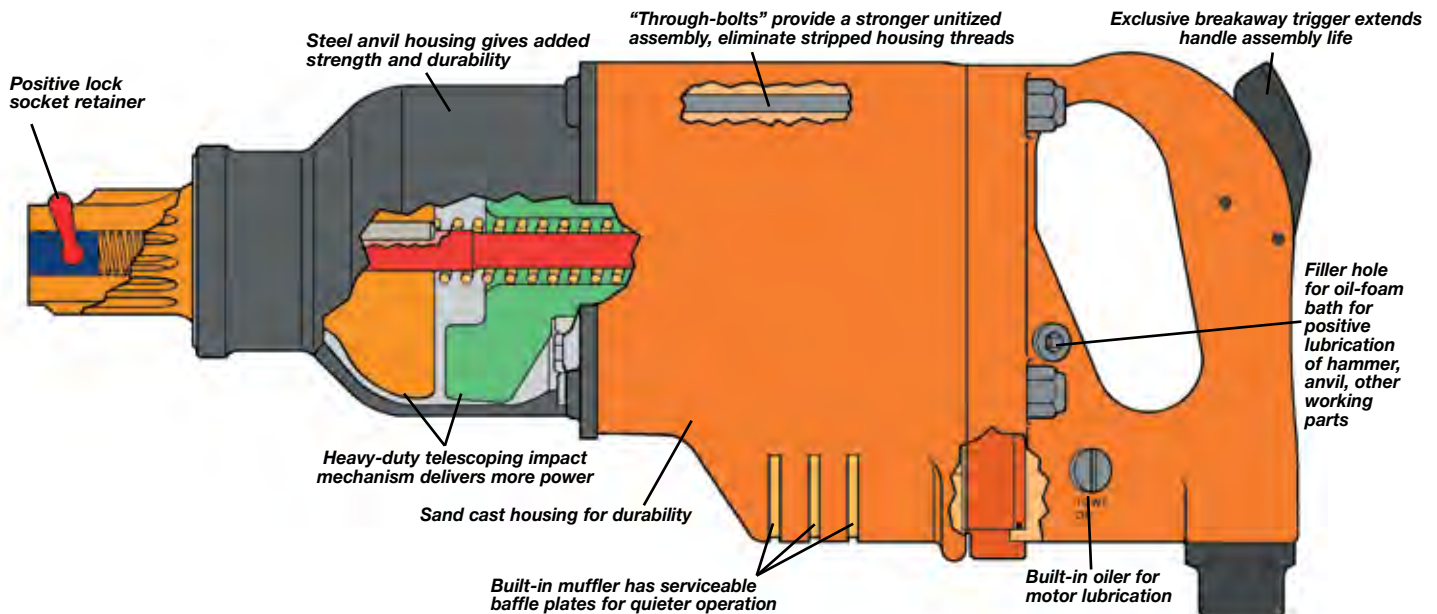

Bolt Selection Chart



The Impact Wrench Bolt Selection Chart will assist you in selecting impact wrenches for specific applications. Torque and tension figures are based on 70% of the proof load of a given size and grade UNC bolt. Torque values are based on non-lubricated (dry) conditions. Bolt grades and sizes are those which are the most commonly secured with impact wrenches.

Bolt Diameter	1/4"	5/16"	3/8"	7/16"	1/2"	9/16"	5/8"	3/4"	7/8"	1"	1-1/8"	1-1/4"	1-3/8"	1-1/2"	1-5/8"	1-3/4"
Torque Ft.-lb.	3	6	11	18	28	43	55	97	155	230	340	480	660	860	-	-
Torque Nm	4.1	8.1	15	24	38	58	75	132	210	312	460	650	900	1,170	-	-
Tension lb.	730	1,210	1,800	2,460	3,280	4,200	5,200	7,000	10,000	14,000	18,200	23,000	28,000	34,600	-	-
Tension kN	3.24	5.38	8.0	10.9	14.6	18.7	23.1	31.1	47.1	62.3	81	102	126	154	-	-

W-200 1/2" sq.
3/8" sq.

WP-455 1/2" sq.

WP-2050 & WP-2049 3/4" sq.
5/8" sq.

WP-2060 & WP-2059 1" sq. & #4 spline
3/4 sq.

W-2110 & W-2109 #5 spline
1" sq.

W-2120 & W-2119 #5 spline 1-1/2" sq.

SAE Grade 5

Bolt Diameter	1/4"	5/16"	3/8"	7/16"	1/2"	9/16"	5/8"	3/4"	7/8"	1"	1-1/8"	1-1/4"	1-3/8"	1-1/2"	1-5/8"	1-3/4"
Torque Ft.-lb.	8	16	28	46	70	110	140	250	405	600	770	1,080	1,470	1,950	-	-
Torque Nm	10.8	21.7	38	62	95	149	190	340	550	810	1,040	1,460	1,930	2,640	-	-
Tension lb.	1,900	3,100	4,600	6,350	8,450	10,900	13,500	20,000	27,400	36,000	41,000	52,000	64,000	77,000	-	-
Tension kN	8.4	13.8	20.4	28.2	37.6	48.5	60	89	122	160	182	231	285	342	-	-

W-200 1/2" sq.
3/8" sq.

WP-455 1/2" sq.

WP-2050 & WP-2049 3/4" sq.
5/8" sq.

WP-2060 & WP-2059 1" sq. & #4 spline
3/4 sq.

W-2110 & W-2109 #5 spline
1" sq.

W-2120 & W-2119 1-1/2" sq.
#5 spline

SAE Grade 8 / ASTM-A354 Grade BD

Bolt Diameter	1/4"	5/16"	3/8"	7/16"	1/2"	9/16"	5/8"	3/4"	7/8"	1"	1-1/8"	1-1/4"	1-3/8"	1-1/2"	1-5/8"	1-3/4"
Torque Ft.-lb.	11	23	40	65	99	159	198	350	566	848	1,245	1,750	2,375	3,135	-	-
Torque Nm	14.9	31.2	54.2	88	134	216	268	475	767	1,150	1,690	2,370	3,220	4,250	-	-
Tension lb.	2,740	4,400	6,510	8,930	11,920	15,290	18,980	28,050	38,800	50,900	66,360	84,000	103,570	125,330	-	-
Tension kN	12.2	19.6	28.9	39.7	53	68	84.4	125	172	226	295	374	461	557	-	-

W-200 1/2" sq.
3/8" sq.

WP-455 1/2" sq.

WP-2050 & WP-2049 3/4" sq.
5/8" sq.

WP-2060 & WP-2059 1" sq. & #4 spline
3/4 sq.

W-2110 & W-2109 #5 spline
1" sq.

W-2120 & W-2119 1-1/2" sq.
#5 spline

ASTM A325*

Bolt Diameter	1/4"	5/16"	3/8"	7/16"	1/2"	9/16"	5/8"	3/4"	7/8"	1"	1-1/8"	1-1/4"	1-3/8"	1-1/2"	1-5/8"	1-3/4"
Torque Ft.-lb.	1						200	355	570	850	1,060	1,495	1,960	2,600	-	-
Torque Nm							271	481	773	1,150	1,440	2,030	2,660	3,530	-	-
Tension lb.							10,000	28,000	39,000	51,000	56,000	71,000	85,000	103,000	-	-
Tension kN							44.5	124	173	227	249	316	378	458	-	-

WP-2050 3/4" sq.

WP-2060 1" sq. 7 #4 spline

WS-2110 #5 spline

WS-2120 #5 spline

ASTM A490*

Bolt Diameter	1/4"	5/16"	3/8"	7/16"	1/2"	9/16"	5/8"	3/4"	7/8"	1"	1-1/8"	1-1/4"	1-3/8"	1-1/2"	1-5/8"	1-3/4"
Torque Ft.-lb.	1						250	435	715	1,070	1,580	2,125	2,780	3,700	-	-
Torque Nm							339	590	970	1,451	2,125	2,882	3,770	5,020	-	-
Tension lb.							24,000	35,000	49,000	64,000	80,000	102,000	121,000	148,000	-	-
Tension kN							107	156	218	285	356	454	538	658	-	-

WP-2050 3/4" sq.

WP-2060 1" sq. 7 #4 spline

WS-2110 #5 spline

WS-2120 #5 spline

*Note: ASTM-325 and ASTM A490 bolts are used on structural steel applications. Torque and tension values are based on running the nut beyond the proof load of the bolt by the turn-of-the-nut method. For detailed information, consult the bolt manufacturer.

Impact Wrenches

Inline, Pistol Grip & Spade Handle

Cleco®

WL & WP Series

Torque Range:	Bolt Size:
20 - 2450 Nm	M10 - M30
15 - 1800 Ft. Lbs	7/16" - 1 1/2"

- Lever and trigger start
- Reverse or forward bias
- 6" extended and spline drives available



WT Series Spade Handle

Torque Range:	Bolt Size:
1000 - 4000 Nm	M30 - M36
750 - 3000 Ft. Lbs	1 3/8" - 1 1/2"

- Inside or outside lever
- Positive lock socket retainer (spline drive)
- Multiposition dead handle
- Oil foam bath
- Reverse or forward bias



Model Number	Bolt Size		Square Drive	Recommended Torque Range		Impacts per Minute	Free Speed	Length		Weight		Side to Center		Air Consumption		
	Gr. 5	Gr. 9.8		ft.-lbs.	Nm			in.	mm	lbs.	kg	in.	mm	NPT	Hose I.D.	SCFM
	in.	mm	in.	ft.-lbs.	Nm	RPM	in.	mm	lbs.	kg	in.	mm	NPT	Hose I.D.	SCFM	
Inline – Lever Start																
WL-200-3	7/16	M10	3/8	15-50	20-68	3,200	3,000	8.5	216	3.1	1.4	1	25	1/4"	1/4"	18
WL-200-4	1/2	M10	1/2	15-60	20-81	3,200	3,000	8.5	216	3.4	1.5	1	25	1/4"	1/4"	18
Pistol Grip – Trigger Start																
WP-255-3P	7/16	M10	3/8	60-75	80-100	1,150	9,500	5.7	145	2.6	1.2	1	25	1/4"	1/4"	30
WP-455-4R	1/2	M20	1/2	37-370	50-502	1,400	6,500	7	176	5.3	2.4	-	-	1/4"	1/4"	40
WP-455-4P***	1/2	M20	1/2	37-370	50-502	1,400	6,500	7	176	5.3	2.4	-	-	1/4"	1/4"	40
WP-2050-6	7/8	M20	3/4	125-600	170-800	1,000	6,000	6.4	162	7.8	3.5	1.6	42	3/8"	3/8"	45
WP-2060B-6	1 1/8	M24	3/4	250-700	350-950	1,000	4,000	7.8	197	12	5.4	1.8	46	3/8"	3/8"	60
WP-2060B-8	1 1/8	M24	1	250-900	350-1200	1,000	4,000	7.8	197	12.1	5.5	1.8	46	3/8"	3/8"	60
WP-2110B-8	1 3/8	M30	1	750-1650	1000-2250	880	4,600	9.5	241	20.8	9.4	2.2	56	1/2"	3/8"	100
Pistol Grip – Trigger Start – Biased Reverse Power****																
WP-2049-6	7/8	M20	3/4	125-550	170-750	1,000	6,200	6.4	162	7.8	3.5	1.6	42	3/8"	3/8"	45
WP-2059-6	1 1/8	M24	3/4	250-700	350-950	1,000	4,000	7.8	197	12	5.4	1.8	46	3/8"	3/8"	60
WP-2059-8	1 1/8	M24	1	250-800	350-1100	1,000	4,000	7.8	197	12.1	5.5	1.8	46	3/8"	3/8"	60
WP-2059-8-6E**	1 1/8	M24	1	250-750	350-1000	1,000	4,000	13.8	350	14.3	6.5	1.8	46	3/8"	3/8"	60
WP-2109B-8	1 3/8	M30	1	750-1650	1000-2250	880	4,300	9.5	241	20.8	9.4	2.2	56	1/2"	3/8"	100
WPS-2109B	1 3/8	M30	#5 Spl.	750-1800	1100-2450	880	4,300	9.8	248	21.3	9.6	2.2	56	1/2"	3/8"	100

* Quick change chuck
 ** 6" Extended spindle
 *** Pin retainer
 ****Breakaway torque capacity in reverse:
 2049 Series: 750 ft.-lbs. (1000 Nm)
 2059 Series: 1200 ft.-lbs. (1600 Nm)
 2109 Series: 2500 ft.-lbs. (3400 Nm)

General:
 Tool performance rated at 90 psi (620kPa) air pressure.
Standard Equipment:
 Operating instructions & service manual

Optional Equipment:
 86909 Suspension bail for WL-200.
 Additional accessories: Pages 63

Model Number		Suitable for Bolt Size		Square Drive	Recommended Torque Range		Impacts Per Minute	Free Speed	Length		Weight		Side to Center		Air Consumption			
Inside Trigger	Outside Trigger	in.	mm		ft.-lbs.	Nm			RPM	in.	mm	lbs.	kg	in.	mm	NPT	Hose I.D.	SCFM
Trigger Start - Spade Handle																		
	WT-2110-8		1 1/2	M30	1	750-1650	1000-2250	880	4,600	12.9	327	21	9.5	2.2	56	1/2"	1/2"	100
	WTS-2120		1 1/2	M36	#5 Spl.	1200-2800	1600-3800	850	3,300	14.3	362	27.6	12.5	2.3	59	1/2"	5/8"	105
	WT-2120-12	W-2120-12	1 1/2	M36	1 1/2	1200-3000	1600-4000	850	3,300	14.3	362	27.6	12.5	2.3	59	1/2"	5/8"	105
Trigger Start - Spade Handle - Biased Reverse Power**																		
	WT-2109-8	W-2109-8	1 3/8	M30	1	750-1650	1000-2250	880	4,300	12.9	327	21	9.5	2.2	56	1/2"	1/2"	100
	WTS-2109		1 3/8	M30	#5 Spl.	800-1800	1100-2450	880	4,300	13.1	333	21.5	9.8	2.2	56	1/2"	1/2"	100
	WT-2119-12		1 1/2	M36	1 1/2	1200-2600	1600-3500	820	3,300	14.3	362	29	13.1	2.3	59	1/2"	5/8"	105
	WTS-2119	WS-2119	1 1/2	M36	#5 Spl.	1200-2500	1600-3400	820	3,300	14.3	362	29	13.1	2.3	59	1/2"	5/8"	105

*6" Extended spindle
 **Breakaway torque capacity in reverse:
 2109 Series: 2500 ft.-lbs. (3400 Nm)
 2119 Series: 3500 ft.-lbs. (4700 Nm)

Standard Equipment:
 Operating instructions & service manual
 Dead handle bracket
 Dead Handle

Optional Equipment:
 Additional accessories: Pages 63

General:
 Tool performance rated at 90 psi (620kPa) air pressure.

General Accessories

Balance Arms

Cleco®

Screwdriver balance arms absorb torque, support weight and improve productivity.

Cleco balance arms are engineered to deliver longer service life using durable components, rugged design and operator-sensitive features.

These arms absorb the torque produced by the screwdriver, eliminating torque reaction to the operator. Balanced by springs or air cylinders, the arm and not the operator supports the weight of the tool. By reducing the fatigue factors, the operator productivity is improved.

Tool movement and placement over the fastener is virtually effortless since most moving parts of the balance arm are mounted on ball bearings. Access to the tool is easily changeable by adjusting the springs or cylinder supporting the forearm.

Arm components and materials are selected for strength and rigidity. Precision aluminum sand castings used in the articulating arm section are light but sturdy.

Over 25 models of the Cleco screwdriver balance arms are available. Air cylinder models are capable of supporting tools weighing up to 10 lbs. (4.5 kg.). Spring models will support tools weighing up to 5 lbs. (2.3 kg.). Both styles have torque capacities of 10 ft. lbs. (13.5 Nm). Arms can be post mounted, wall mounted or mounted on an adjustable height post. Tool holders for all models will accommodate most major brands of air tools...straight and pistol.

Tool Holders

Selecting the proper tool holder for the tool used on Cleco balance arms enhances the ergonomic benefits of the arm. Tool holders allow the tool to swing, swivel and rotate, enabling the operator to work more comfortably and productively.

Standard and extended tool holders are available for parallel balance arms. Both models hold the tool perpendicular to the work, and are ideal for self-tapping and thread forming applications. Tool diameter capacity is up to 1 3/4 inch (45mm).

Manifold tool holders used on SBA and CSBA balance arms suspend the tool from the air inlet. They allow the tool to swing (or swivel when equipped with the optional swivel assembly) for ease of tool movement.



General Accessories

Balancers



Ergonomic Tool Balancers

Capacity:
0.5 - 20.5 kg
1.0 - 45 Lbs.

External tension adjustment

- 360° Swivel
- Retracting in-line cable

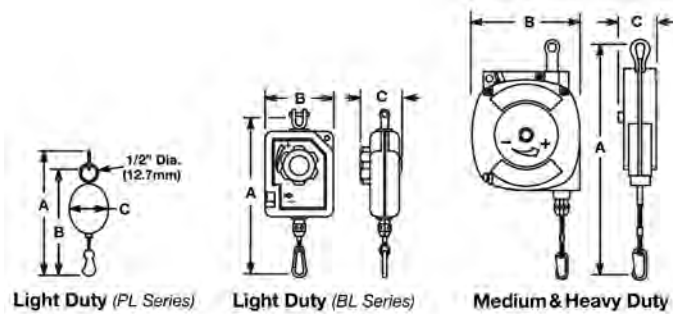

Model Number	Lock Feature	Capacity		"A"		"B"		"C"		Weight	
		lbs.	kg	in.	mm	in.	mm	in.	mm	lbs.	kg
Light Duty – 4.6 ft. (1.4m) Cable Travel											
PL-12A	–	12.0-1.0	5.5-0.5	6.8	171	5.1	130	2.3	58	–	–
Light Duty – 5.0 ft. (1.5m) Cable Travel											
200427	–	2.0-0	.9-0	10.9	277	4.4	112	1.6	41	1.3	0.6
200428	–	4.0-2.0	1.8-.9	10.9	277	4.4	112	1.6	41	1.3	0.6
200429	–	5.0-3.0	2.3-1.4	10.9	277	4.4	112	1.6	41	1.3	0.6
Light Duty – 5.2 ft. (1.6m) Cable Travel											
BL-2A	–	2.0-1.0	0.9-0.5	10.4	263	4.0	102	2.2	56	1.1	0.5
BL-4A	–	4.0-2.0	1.8-0.9	10.4	263	4.0	102	2.2	56	1.1	0.5
Light Duty – 6.7 ft. (2.0m) Cable Travel											
BL-6A	–	6.0-4.0	2.7-1.8	12.9	327	5.5	140	3.1	79	3.3	1.5
BLL-6A	Ratchet	6.0-4.0	2.7-1.8	12.9	327	5.5	140	3.1	79	3.3	1.5
BL-8A	–	8.0-6.0	3.6-2.7	12.9	327	5.5	140	3.1	79	3.3	1.5
BLL-8A	Ratchet	8.0-6.0	3.6-2.7	12.9	327	5.5	140	3.1	79	3.3	1.5
Medium Duty – 6.6ft. (2.0m) Cable Travel											
BM-13A	Automatic	13-9.0	5.9-4.1	13.8	350	6.9	175	4.5	114	9.0	4.1
BML-13A	Automatic/Ratchet	13-9.0	5.9-4.1	13.8	350	6.9	175	4.5	114	9.0	4.1
BM-18A	Automatic	18-13	8.2-5.9	13.8	350	6.9	175	4.5	114	9.0	4.1
Medium Duty – 6.0ft. (1.8m) Cable Travel											
BM-25A	Automatic	25-18	11.4-8.2	20.7	527	7.8	197	6.6	169	19	8.6
BM-35A	Automatic	35-25	15.9-11.4	20.7	527	7.8	197	6.6	169	19	8.6
BM-45A	Automatic	45-35	20.5-15.9	20.7	527	7.8	197	6.6	169	19	8.6

General Accessories

Air Cylinder & Spring Balance Arms

Cleco®

- Ball bearing construction
- Supports tools weighing up to 5 lbs. (spring models) or up to 10 lbs. (air cylinder models).
- Post, wall, or adjustable height post mounting
- Single or parallel arms

*Air Cylinder
Single Arm Post
CPBA-18*

*Air Cylinder
Parallel Arm
Adjustable Height
CPBA-18-AH*

*Spring
Parallel Arm Post
PBA-18*

*Spring
Single Arm
Adjustable Height
SBA-18-AH*

Post mounting template

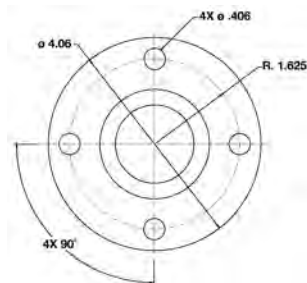

TOOLS NOT INCLUDED

Single Arms		Parallel Arms		Dimensions							
Model No.	Ordering No.	Model No.	Ordering No.	A		B		C		D	
				in.	mm	in.	mm	in.	mm	in.	mm
CSBA18	520160	CPBA-18	520170	12	305	18	457	18	457	-	-
CSBA-24	520200			12	305	24	610	18	457	-	-
CSBA-30	520201	CPBA-30	520203	12	305	30	762	18	457	-	-
CSBA-12-AH	520165	CPBA-12-AH	520178	12	305	12	305	-	-	30	762
CSBA-18-AH	520162	CPBA-18-AH	520172	12	305	18	457	-	-	30	762
CSBA-30-AH	520167	CPBA-30-AH	520175	12	305	30	762	-	-	30	762
		CPBA-30-WM	520207	12	305	30	762	-	-	-	-

Air Cylinder Models

AH = Adjustable Height
 WM = Wall Mounted
 Tool weight capacity: 10 lbs. (4.6 kg)
 Torque capacity: 10 ft. lbs. (13.5 Nm)

Standard Equipment
 Operating Instructions and Service Manual.
 Regulator for Air Cylinders.
 Threaded Nipples for CSBA Models
 1/4 NPT Hex Nipple: 204032
 1/4 NPT x 1/8 NPT Hex Reducer
 Nipple: 204137

Optional Equipment
 Additional accessories: See page 62.

Single Arms		Parallel Arms		Dimensions							
Model No.	Ordering No.	Model No.	Ordering No.	A		B		C		D	
				in.	mm	in.	mm	in.	mm	in.	mm
SBA-12	520001	PBA-12	520007	12	305	12	305	18	457	-	-
SBA-18	520004	PBA-18	520010	12	305	18	457	18	457	-	-
		PBA-24	520045	12	305	24	610	18	457	-	-
SBA-12-AH	520003	PBA-12-AH	520009	12	305	12	305	-	-	30	762
SBA-18-AH	520006	PBA-18-AH	520012	12	305	18	457	-	-	30	762
SBA-24-AH	520110	PBA-24-AH	520047	12	305	24	610	-	-	30	762
SBA-30-AH	520044	PBA-30-AH	520050	12	305	30	762	-	-	30	762
		PBA-18-18-AH	520036	18	457	18	305	-	-	30	762
		PBA-12-WM	520008	12	305	12	305	-	-	-	-
SBA-30-WM	520043			12	305	30	762	-	-	-	-

AH = Adjustable Height
 WM = Wall Mounted
 Tool weight capacity: 5 lbs. (2.3 kg)
 Torque capacity: 10 ft. lbs. (13.5 Nm)

Standard Equipment
 Operating Instructions and Service Manual.
 Threaded Nipples for SBA Models
 1/4 NPT Hex Nipple: 204032
 1/4 NPT x 1/8 NPT Hex Reducer
 Nipple: 204137

Optional Equipment
 Additional accessories: See page 62.

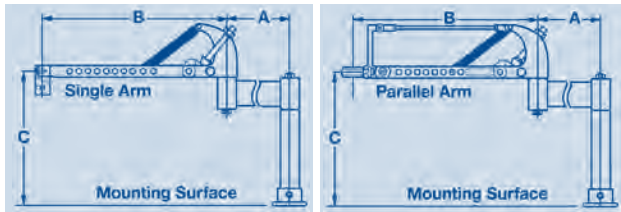

Balance Arm Operating Envelope

MODEL	R1 MAX		R1 MIN		R2 MAX		R2 MIN		H MAX		H MIN	
	in.	mm	in.	mm	in.	mm	in.	mm	in.	mm	in.	mm
SBA-12	24	610	2	51	18	457	8	203	15	381	6	152
SBA-18	30	762	6	152	20	508	7	178	15	381	0	0
PBA-12	26	660	3	76	20	508	7	178	17	432	8	203
PBA-18	32	813	8	203	22	559	6	152	17	432	2	51

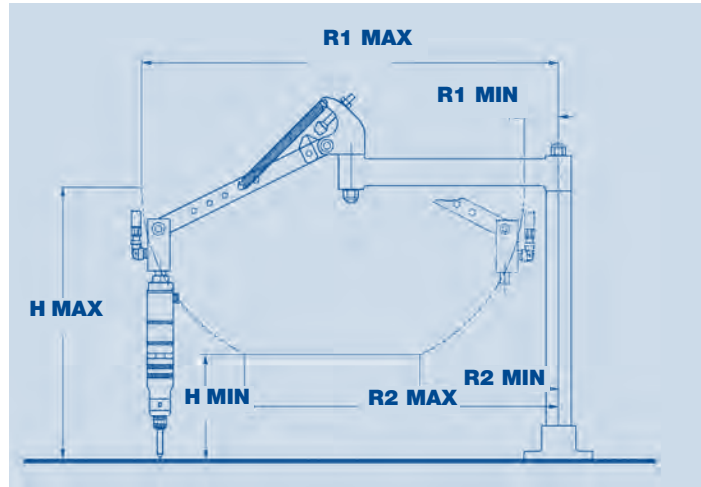

XX BA - XX - XX - XX

Series
 CS - Air cylinder, single arm
 S - Spring, single arm
 CP - Air cylinder, parallel arm
 P - Spring, parallel arm

Tool Type
 BA - Balance Arm

Arm Extension
 12" 24"
 18" 30"
 (12" unless specified)

Mount
 - - Post
 AH - Adjustable Height
 WM - Wall Mount

Adjustable Arm Extension
 12" 24"
 18" 30"

General Accessories

Air Cylinder & Spring Balance Arm Accessories

Single Arm Tool Holders

Part Number	Description
201690*	Manifold tool holder
201601*	Swivel manifold tool holder

*Use of 201601 requires 201690.

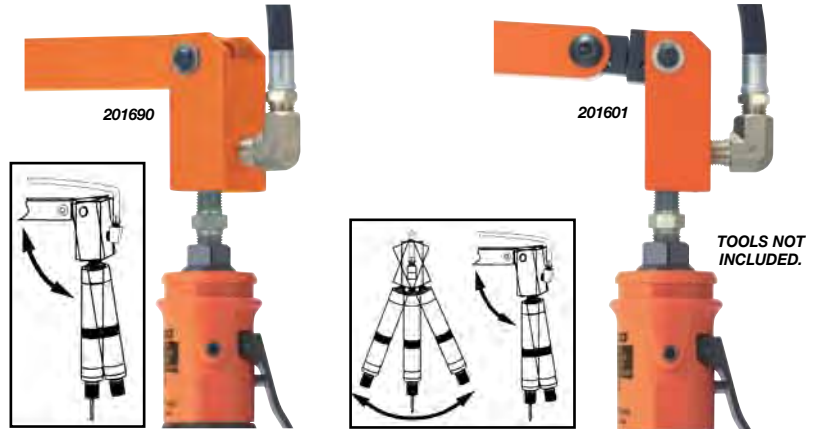

Parallel Arm Tool Holders

Part Number	Description
201675	Parallel tool holder
204167	Extended parallel tool holder
201607	Swivel tool holder (small)
201608	Swivel tool holder (large)

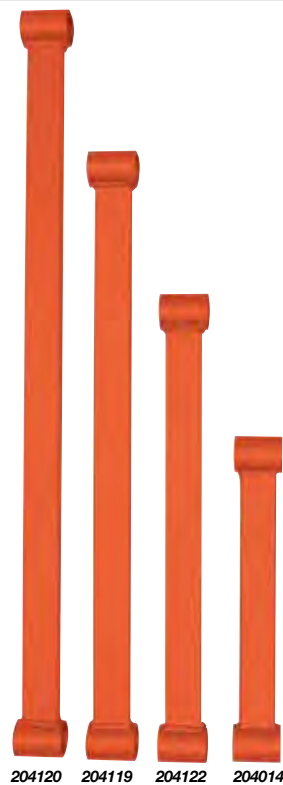

Articulating Arm Extensions

Part Number	Length (inches)
204014	12
204122	18
204119	24
204120	30

Conversion Kits for Cleco Screwdriver Balance Arms

To Convert Balance Arms		Part No.
From	To	
SBA-12	PBA-12*	521041
SBA-18	PBA-18*	521042
Spring	Cylinder	201606
SBA or PBA Standard Duty	SBA or PBA Heavy Duty**	521060

* Conversion kits for -24 and -30 models are available upon request.
 ** Has four springs to support heavier tools or longer arms.

General Accessories

Cleco®

Air Hoses

Part Number	Hose I.D.		Fittings (NPT)		Length	
	in.	mm	in.	mm	ft.	m
A139856	3/16	4.7	1/8	1/8	6.0	1.8
45-1307	3/16	4.7	1/8	1/4	7.0	2.1
45-1408	1/4	6.4	1/4	1/4	8.0	2.4
45-1409	1/4	6.4	1/8	1/4	8.0	2.4
45-1508	5/16	7.9	1/4	1/4	8.0	2.4
45-1610	3/8	9.5	3/8	3/8	10	3.0
45-1810	1/2	12.7	3/8	1/2	10	3.0
45-1812	1/2	12.7	1/2	1/2	12	3.7
45-1825	1/2	12.7	1/2	1/2	25	7.6

General: 3/16" & 1/4" hoses have braided covers, all others have neoprene covers.

*Note: 3/8"-24 is a straight thread



Activeswivel

Part No.	NPT in.	Air Flow		Max. Pressure		Weight	
		SCFM	m ³ /min	psig	bar	lbs.	kg
SW-102	1/4	25	7.1	150	10.4	0.20	0.09
SW-103	3/8	45	12.7	150	10.4	0.40	0.18
SW-104	1/2	65	18.4	150	10.4	0.80	0.36
SWR-102*	1/4	25	7.1	150	10.4	0.25	0.11

* NOTE: Equipped with built-in flow regulator.

Quick Disconnect Fittings

Fitting Type*	NPT in.	Nominal Size		
		1/4"	3/8"	1/2"
Coupler (male NPT)				
	1/8	45-0710	-	-
	1/4	45-0711	45-0713	-
	3/8	45-0712	-	-
	1/2	-	-	45-0717
Coupler (female NPT)				
	1/4	-	-	-
	3/8	45-0732	45-0734	45-0736
Nipple (male NPT)				
	1/8	45-0720	-	-
	1/4	-	45-0724	-
	3/8	45-0722	45-0725	45-0726
	1/2	-	-	45-0727
Nipple (female NPT)				
	1/4	-	45-0744	-
	3/8	45-0742	45-0745	45-0746
	1/2	-	-	45-0747
Nipple (with hose barbs)				
	1/4**	45-0748	-	-
	1/2**	-	-	45-0753

* NOTE: Nipples of one size will not fit couplers of another size.

** NOTE: Indicates inside diameter of hose.

NOTE: 1/4" nominal will pass 49 cfm free air @ 90 psi, but pressure drop exceeds 10 psi with air flow over 30 cfm.

3/8" nominal will pass 90 cfm free air @ 90 psi, but pressure drop exceeds 10 psi with air flow over 53 cfm.

1/2" nominal will pass 168 cfm free air @ 90 psi, but pressure drop exceeds 10 psi with air flow over 109 cfm.

Lubricants

Part Number	Size	Description	M.S.D.S. No.
Oils			
540397	1 qt. plastic	Air line oil	CPT-153
533485	1 gal. metal	Air line oil	CPT-153
536333	1 gal. metal	High film strength	CPT-154
45-0918	1 qt. plastic	Air line oil (Dotco)	CPT-155
45-0919	1 gal metal	Air line oil (Dotco)	CPT-155
539317	1 qt. plastic	Hydraulic oil (Pulse)	CPT-157
Greases			
513156	18 oz. can	Teflon grease	CPT-145
540394	2.8 oz. tube	Teflon grease	CPT-145
45-0983	2 oz. tube	Dotco gear grease	CPT-147
45-0980	2 oz. tube	Dotco gear lube	CPT-148

NOTE: Under normal conditions of use, lubrication products sold separately for or used within these tools should not cause an exposure hazard. Refer to the Material Safety Data Sheet (M.S.D.S.) for Safety and Disposal information. M.S.D.S. sheets shown in the chart are available upon request from Cooper Tools.



Push Type Grease Gun

Part Number: 45-1982

General Accessories

Apex Fastener Tools

APEX®

Quality Fastener Tools

For more than half a century Apex has maintained the position of world leader in industrial fastening tools. Many power and insert bits, socket combinations and other drivers/adapters pioneered by Apex have today become industry standards, while Apex quality, service and selection give you unsurpassed value.

More Quality For Your Money

Apex quality starts with the selection of raw materials. Only carefully chosen, high grade tool steel is used to make Apex industrial fastener tools. Next, each tool is precision machined from solid bar stock to exacting standards of accuracy. You always get a snug, secure fit – a fit that is not possible from stamped tools.

Finally, each Apex fastener tool is tempered with our exclusive heat treating process. During this step the degree of hardness is determined based upon the application.

Special Orders

Apex offers the broadest selection of screw driver and nut runner tools available, from bits, sockets and universal wrenches to extensions, adapters and nut setters. If you have a special application, contact your Apex representative. We may have what you need in stock, or can design and produce special fastener tools for almost any application.



Registered Trade Marks: HI-TORQUE, Voi-Shan; TORX, Camcar Division of Textron; ACR, POZIDRIV, TORQ-SET and TRI-WING, Phillips International Co.; SUPADRIV, EIS (Fasteners) LTD.; SEL-O-FIT, FLIP-TIP, and Apex, Apex Tool Group, LLC.

Insert Bits

(1/4" hex for socket head cap screws and set screws)

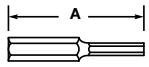

Part Number	Hex Size (in.)	"A"		Cap Screw	Set Screw
		in.	mm		
185-00	1/16	1.00	25.4	1	5.6
185-0	5/64	1.00	25.4	2.3	8
185-1	3/32	1.00	25.4	4.5	10
185-9	7/64	1.00	25.4	6	—
185-2	1/8	1.00	25.4	8	1/4
185-10	9/64	1.00	25.4	8	—
185-3	5/32	1.31	33.3	10	5/16
185-4	3/16	1.31	33.3	1/4	3/8
185-5	7/32	1.31	33.3	—	7/16
185-6	1/4	1.31	33.3	5/16	1/2
185-7	5/16	1.25	31.8	3/8	5/8
185-8	3/8	1.25	31.8	7/16, 1/2	3/4

Square Drive Adapter

(1/4" hex drive sockets) Use with Quick Change and Bit & Finder Models, except as noted.

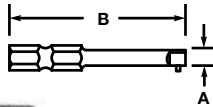

Part Number	"A" Sq. Drive	"B"		Bushings Number
		in.	mm	
EX250-2	1/4	2.00	50.8	—
EX250-3	1/4	3.00	76.2	847295*
EX250-4	1/4	4.00	101.6	—
EX250-6	1/4	6.00	152.4	—
EX370	3/8	1.63	41.3	—
EX370-3	3/8	3.00	76.2	847295*
EX500-2	1/2	2.00	50.8	—
EX500-3	1/2	3.00	76.2	—

*Note: Required for bit and finder models.

Hex Extensions

Part Number	Hex Drive (in.)	Type of Lock	Overall Length	
			in.	mm

Male Hex Drive with 1/2" Male Square

EX-501-3	7/16	Pin	3	76
EX-501-4	7/16	Pin	4	102
EX-501-6	7/16	Pin	6	152

Male Hex Drive with 3/8" Male Square

EX-371-3	7/16	Pin	3	76
EX-371-4	7/16	Pin	4	102
EX-371-6	7/16	Pin	6	152



Hex Drive Nutsetters

Part Number	Size (in.)	Overall Length (in.)	Socket Nose Diameter (in.)
-------------	------------	----------------------	----------------------------

7/16" 6 Point

6N-1416-3	1/2	3	13/16
6N-1416-4	1/2	4	13/16
6N-1418-3	9/16	3	7/8
6N-1418-4	9/16	4	7/8
6N-1420-3	5/8	3	1
6N-1420-6	5/8	6	1



Insert Bits

Used with Bit Holders (all bits are 1.0" (25.4 mm) long)



Point Size	Part Number		Wood		Machine & Self-Tapping			
	Phillips	Pozi-Drive	Flat & Oval	Round	Flat, Oval & Pan	Fillister	Truss	Binding
0	446-0	446-1P2D	0.1	0.1	0.1	0.1	0.1	0.1
1	HPL-1	440-1PZD	2-4	2-4	2-4	2-4	2-4	2-4
2	HPL-2	440-2PZD	5-8	5-10	5-10	5-10	6-10	5-10
3	HPL-3	440-3PZD	10-16	12-16	12-16	12-5/16	12-16	12-1/4

6 Point Sockets

Part No.	Hex Opening	Overall Length	Nose End Diameter	Drive End Diameter	Opening Depth
----------	-------------	----------------	-------------------	--------------------	---------------

3/8" Square Drive Sockets, SAE

3112	3/8	1 1/4	19/32	3/4	1/4
3114	7/16	1 1/2	11/16	3/4	9/32
3116	7/16	1/2	1 1/2	13/16	11/32
3118	7/16	9/16	1-1/2	7/8	7/16

1/2" Square Drive Sockets, SAE

5112	3/8	1 1/2	5/8	15/16	1/4
5114	7/16	1 1/2	11/16	15/16	9/32
5116	1/2	1 1/2	13/16	15/16	11/32
5120	5/8	1 1/2	1	1	7/16
5122	11/16	1 1/2	1 1/8	1 1/8	7/16
5124	3/4	1 1/2	1 1/8	1 1/8	15/32

3/4" Square Drive Sockets, SAE

7128	7/8	2	1 1/2	1 1/2	9/16
7132	1	2	1 5/8	1 5/8	5/8
7136	1 1/8	2 1/8	1 3/4	1 3/4	3/4
7140	1 1/4	2 1/8	2	1 3/4	13/16
7144	1 3/8	2 1/8	2 1/8	2 1/8	13/16
7148	1 1/2	2 1/4	2 1/4	2 1/8	1

1" Square Drive Sockets, SAE

8132	1	2 1/8	1 5/8	2	13/16
8140	1 1/4	2 1/8	2 1/8	2 1/8	13/16
8144	1 3/8	2 1/8	2 1/8	2 1/8	13/16
8148	1 1/2	2 1/4	2 1/4	2 1/8	15/16
8156	1 3/4	2 3/8	2 5/8	2 5/8	11/16
8164	2	2 5/8	3	2 5/8	1 3/16

1 1/2" Square Drive Sockets, SAE

9156	1 3/4	2 7/8	2 7/8	3	1 1/8
9160	1 7/8	3	3 1/8	3	1 1/4
9164	2	3 1/8	3 1/4	3 1/4	1 3/8
9172	2 1/4	3 1/4	3 3/8	3 1/4	1 1/2

3/8" Square Drive Sockets, Metric

12mm13	12	38.1	19.1	19.1	7.2
14mm13	14	38.1	22.2	22.2	11.1
16mm13	16	38.1	23.8	23.8	11.1

1/2" Square Drive Sockets, Metric

16mm15	16	38.1	25.4	25.4	11.1
18mm15	18	38.1	28.6	28.6	11.1
20mm15	20	38.1	31.7	31.7	11.9
22mm15	22	38.1	33.3	33.3	14.3

5/8" Square Drive Sockets, Metric

24mm16	24	51	38.1	38.1	15.9
--------	----	----	------	------	------

3/4" Square Drive Sockets, Metric

28mm17	28	54	44.4	44.4	19.1
30mm17	30	54	47.6	44.4	19.1
32mm17	32	54	50.8	44.4	20.6
34mm17	34	54	54.0	54.0	20.6
36mm17	36	57	57.1	54.0	23.8

1" Square Drive Sockets, Metric

32mm18	32	54	54.0	54.0	20.6
34mm18	34	54	54.0	54.0	20.6
36mm18	36	57	57.1	54.0	23.9
38mm18	38	57	57.1	54.0	23.9
42mm18	42	60	63.5	54.0	23.9
46mm18	46	64	69.8	66.7	26.9



General Accessories

Apex μ -Guard

APEX® μ -Guard™

Quality Anti-Mar Fastener Tools Begin With Quality Fastener Tools.

Apex μ -Guard™ provides a protective barrier between genuine Apex fastener tools and your finely finished workpiece. The free-spinning patent-pending design provides maximum protection for polished and highly sensitive surfaces.

Apex μ -Guard™ covering is made of a thermo plastic urethane (TPU elastomer) which cushions against costly incidental side impacts. It offers the lowest coefficient of friction for maximum tool efficiency. It is also non-removable for tamper resistance.

With Apex μ -Guard™ you get the proven Apex fastener tool fit and performance plus the best protection available against marring and in-system damage.

μ -Guard™ is your guard against the potential hazards caused by rotational friction.



*If it doesn't say Apex
on the outside, how can
you be sure of what's
on the inside?*

Prevents Side Impact Damage



Free-Spinning Design



Virtually Damage Free



Pneumatic Assembly Tool Safety

Cleco®

General Safety Instructions

These Safety Instructions must be accessible to the operator at all times. They must be shown and made available to all people involved in the use of the tool.



The operator must understand the Safety Instructions and the Installation, Operation, and Adjustment Procedures provided in the Technical Manual (included with the tool). These Safety Instructions are not intended to be all inclusive. Study and comply with all applicable Federal, State, and Local Regulations. Contact your local distributor for assistance.



This symbol identifies the potential for a hazardous situation. If this warning is not followed, a serious injury could occur.



Always disconnect the tool from the air hose before adjusting or repairing.



Immediately shut off the tool in the case of unusual sound or vibration. Disconnect the tool from the air hose. Have a qualified person check the tool and repair before using.

When unpacking the tool, closely check for shipping damages and accuracy of the shipping documentation.



Do not wear loose clothing, jewelry, or rings. Injury may result from being caught in tools. Avoid direct contact with lubricants, grease or adhesives.



Safety glasses or face shield must be worn.



Wear gloves, ear protection and other protective equipment when required.

Do not modify the tool, any guard or accessory unless approved in writing by Apex Tool Group.

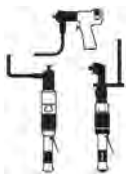

We recommend the use of a reaction bar to prevent an uncontrollable reaction of the tool. This use is dependant on the following factors: torque, joint, air pressure, form of the tool and the individual user. Consider the use of reaction bars to prevent possible injury.

Implement and follow a Safety Maintenance Program to provide inspection and maintenance of all phases of tool operation and air supply equipment.



Sockets and bits used with nutrunners and screwdrivers should be of the power tool or industrial type. Do not use hand tool sockets on a power tool. Hand tool sockets can break, resulting in a hazard of flying pieces. Worn sockets or bits reduce the power delivered to the fastener, cause drive wear and increase the chance for breakage. Inspect sockets, bits and drives for wear or damage and replace as necessary.

Noise & Vibration

Refer to test data page included with tool.

Intended Use

Air assembly tools are intended for tightening of threaded joints only. Tools must be used for their designated purpose. Do not use as a hammer, lever or other improper usage that can cause tool damage and lead to operator injury.

Installation & Operation

Only qualified and trained operators should install, adjust or use air assembly tools.

Connect the tool to an air line with a maximum pressure of 6.2 bar (90 psig). Adjust the air line lubrication to a minimum to reduce possible contamination of the environment by the exhaust air. The work area must be well ventilated.



Inspect the air hose and fittings. Do not use damaged, frayed or deteriorated hoses. A hose rupture can cause injury.



When using right angle nutrunners, be sure the throttle is positioned relative to the angle head so the throttle will not become wedged against an adjacent object in the ON position due to torque reaction.

The angle head may be repositioned with respect to the lever to accommodate proper location for the task. If the tool is to be reversed, locate throttle lever in a neutral position that will prevent entrapment.

Keep the tool clean and dry to provide the best possible grip. The tool should be held in such a way to be safe and comfortable. Firmly grasp the handle of the tool and apply the socket to the joint before starting the tool.

Adjusting Torque For Shut-Off Tools



Screwdrivers and nutrunners with clutches can stall rather than shut off if the clutch is adjusted over the maximum power output of the tool, or if there is a drop in the air pressure. Low or fluctuating air pressure can cause tool to fail to shut off! The user must be prepared to resist the torque until the throttle is released.

Expose clutch through movement of the clutch shield. Using the hex wrench supplied, turn clockwise for maximum torque or turn counterclockwise for minimum torque.

NOTE: For best results, start from "MIN" torque and adjust in "MAX" direction.

Maintenance, Assembly & Disassembly

Inspect air assembly tools every 500 operating hours or every six months, whichever comes first. Replace worn parts using only genuine Apex Tool Group replacement parts.

Model Number Index

Model	Page	Model	Page	Model	Page	Model	Page
200427	13,59	539317	53,63	867938	13	19PCA03Q	9
200428	13,59	540394	63	869168	13	19PCA04Q	9
200429	13,59	540397	63	869203	13	19PCA05Q	9
201012	36	542523	53	869204	13	19PCA06Q	9
201034	36	542892	39	869305	13	19PCA07Q	9
201039	36	550006	36	869306	13	19PCA09Q	9
201203	12	809451	12	869734	13	19PTA02Q	9
201510	36	809453	12	869770	36	19PTA03Q	9
201601	62	809470	12	928473	53	19PTA04Q	9
201606	62	809471	12	928474	53	19PTA05Q	9
201607	62	809473	12	928475	53	19PTA06Q	9
201608	62	809474	12	928477	53	19PTA07Q	9
201675	62	847245	12	928483	53	19PTA09Q	9
201690	62	847294	12	928485	53	19PTA15Q	9
201770	13	847299	12	928486	53	19PTS02Q	11
201898	36	847300	12	930119	53	19PTS03Q	11
201900	36,39	847301	12	931041	53	19PTS04Q	11
202346	13	847302	12	931663	53	19PTS05Q	11
202464	13	847303	12	931962	13	19RAA02AH2	19
202822	13	847304	12	932072	53	19RAA02AH3	19
202869	13	847305	12	934918	39,53	19RAA02AM2	19
202870	13	847480	12	935472	53	19RAA03AH2	19
203621	13	847481	12	935965	53	19RAA03AH3	19
203632	13	847482	12	935966	53	19RAA03AM2	19
203762	13	847483	12	939348	39	19RAA04AM2	19
203808	13	847484	12	46037036	36	19RAA05AM2	19
203833	13	847485	12	46037081	36	19RAA06AH2	19
204014	62	847486	12	46177030	36	19RAA06AH3	19
204119	62	847487	12	46437006	36	19RAA07AH2	19
204120	62	847488	12	46607016	36	19RAA07AH3	19
204122	62	849153	12	46607058	36	19RAA09AH2	19
204167	62	849154	12	48047128	36	19RAA09AH3	19
204987	36	849155	12	54397004	36	19RAA11AH2	19
205831	36	849156	12	110PHH55Q	52	19RAA11AH3	19
205833	36	849325	12	110PTHH30Q	51	19RAA12AH2	19
205834	36	849617	12	11PHH652	52	19RAA12AH3	19
205835	36	849618	12	11PHH653	52	19RAS03AM2	23
205837	36	849619	12	11PHH65Q	52	19RAS04AH2	23
205838	36	849620	12	11PTHH352	51	19RAS05AM2	23
205839	36	849621	12	11PTHH353	51	19RAS06AH3	23
207019	13	849843	12	11PTHH35Q	51	19SCA02B	7
207237	39	849879	12	120PHH554	52	19SCA02Q	7
207238	39	849891	12	120PTHH304	51	19SCA03B	7
301071	30	849892	12	140PH45Q	52	19SCA03Q	7
301072	30	849893	12	140PTHC25Q	51	19SCA04B	7
301081	36	849894	12	15STHC40Q	51	19SCA04Q	7
301106	13,36,39	849895	12	15STHFC40Q	51	19SCA05B	7
301108	36	849896	12	160PH456	52	19SCA05Q	7
412603	13	849897	12	160PTHC256	51	19SCA06B	7
513156	63	849898	12	19BPA02Q	7	19SCA06Q	7
521041	62	861006	13	19BPA03Q	7	19SPA02B	7
521042	62	863242	12	19BPA04Q	7	19SPA02Q	7
521060	62	865777	13	19BPA05Q	7	19SPA03B	7
533485	63	867711	36	19BPA06Q	7	19SPA03Q	7
536333	63	867931	13	19PCA02Q	9	19SPA04B	7

Model	Page	Model	Page	Model	Page	Model	Page
19SPA04Q	7	250PHF406	52	34RAS73F3	28	45-0732	63
19SPA05B	7	250PTHFC226	51	34RAS73H3	32	45-0734	63
19SPA05Q	7	2RSA-10B	7	34RCA30D1	30	45-0736	63
19SPA06B	7	2RSA-10SB	7	34RCA30D3	30	45-0742	63
19SPA06Q	7	301937PT	36,39	34RCS29D1	30	45-0744	63
19TCA02Q	9	302021PT	13,39	34RCS29D3	30	45-0745	63
19TCA03Q	9	34NRS29H15	43	35PHH653	52	45-0746	63
19TCA04Q	9	34NRS31H16	43	35PHH65Q	52	45-0747	63
19TCA05Q	9	34NRS35H20	43	35PTHH403	51	45-0748	63
19TCA06Q	9	34NRS36H15	43	35PTHH40Q	51	45-0753	63
19TCA07Q	9	34NRS36H18	43	35RSA-10-3	7	45-0918	63
19TCA09Q	9	34NRS38H16	43	35RSA-10Q	7	45-0919	63
19TTA02Q	9	34NRS42H25	43	35RSA-20Q	7	45-0980	63
19TTA03Q	9	34NRS46H18	43	35RSA-5-3	7	45-0983	63
19TTA04Q	9	34NRS46H20	43	35RSA-5Q	7	45-1307	63
19TTA05Q	9	34NRS48H29	43	35RSA-7Q	7	45-1408	63
19TTA06Q	9	34NRS52H25	43	35RSAP-10Q	10	45-1409	63
19TTA07Q	9	34NRS53H37	43	35RSAP-7Q	10	45-1508	63
19TTA09Q	9	34NRS63H29	43	35RSAPT-5Q	10	45-1610	63
19TTA15Q	9	34NRS68H37	43	35RSAPT-7Q	10	45-1810	63
19TTS02Q	11	34RAA08AL3	19	35RSATP-10-3	10	45-1812	63
19TTS03Q	11	34RAA09F1	28	35RSATP-10Q	10	45-1825	63
19TTS04Q	11	34RAA11AL3	19	35RSATP-20Q	10	45-1982	63
19TTS05Q	11	34RAA15AM3	19	35RSATP-5-3	10	45NAB-3P-4	21
207596PT	13	34RAA16F1	28	35RSATP-5Q	10	45RNAB-2-4	27
207652PT	13	34RAA26AH3	19	35RSATP-7Q	10	45RNAB-2P-4	21
207696PT	13	34RAA28AH3	19	35STHFA404	51	45RNAB-2T-4	21
20PHH753	52	34RAA28F1	28	35STHFA40Q	51	45RNAB-3-3	27
20PHH75Q	52	34RAA33AX3	19	35STHFC404	51	45RNAB-3P-4	21
20PTHH403	51	34RAA33F2	28	35STHFC40Q	51	45RNAB-3T-4	21
20PTHH40Q	51	34RAA37AX3	19	400PHF356	52	45RNAB-4-3	27
24NRS15A12	43	34RAA47AX3	19	400PTHFC206	51	45RNAB-4T-4	21
24NRS15A13	43	34RAA47F2	28	41NDR130H15	44	45RNAB-6-3	27
24NRS20H15	43	34RAA53F2	28	41NDR130H16	44	45RNB-2T-4	23
24NRS21H16	43	34RAA53H3	32	41NDR130H18	44	45RNB-3P-4	23
24NRS23A13	43	34RAA67F3	28	41NDR130H20	44	45RNB-3T-4	23
24NRS23H15	43	34RAA67H3	32	41NDR130H25	44	45RNB-4T-4	23
24NRS23H20	43	34RAA68AZ3	19	41NDR172H15	44	541715-5	36
24NRS24A12	43	34RAA68AZ4	19	41NDR172H16	44	55NAL-2T-4	21
24NRS24H16	43	34RAA75AZ3	19	41NDR172H20	44	55NAL-3P-4	21
24NRS24H18	43	34RAA75AZ4	19	41NDR172H25	44	55NAL-3T-4	21
24NRS29H18	43	34RAA94F3	28	41NDR236H15	44	55NAL-4P-4	21
24NRS29H25	43	34RAA94H3	32	41NDR236H16	44	55NAL-4T-4	21
24NRS30H20	43	34RAS103F3	28	41NDR236H18	44	55NL-2T-4	23
24RAA06AL3	19	34RAS103H3	32	45-0710	63	55NL-3T-4	23
24RAA07AL3	19	34RAS10F1	28	45-0711	63	55PHH603	52
24RAA11AL3	19	34RAS11AL3	23	45-0712	63	55PTHH403	51
24RAA12AM3	19	34RAS18F1	28	45-0713	63	55RNAL-2-4	27
24RAA19AM3	19	34RAS28AH3	23	45-0717	63	55RNAL-2T-4	21
24RAA23AM3	19	34RAS30F1	28	45-0720	63	55RNAL-3-4	27
24RAS13AM3	23	34RAS36AX3	23	45-0722	63	55RNAL-3P-4	21
24RTA12	34	34RAS40F2	28	45-0724	63	55RNAL-3T-4	21
24RTA20T2	34	34RAS52F2	28	45-0725	63	55RNAL-4-4	27
24RTA30T3	34	34RAS58F3	28	45-0726	63	55RNAL-4P-4	21
24RTA40T4	34	34RAS58H3	32	45-0727	63	55RNAL-4T-4	21



Model	Page	Model	Page	Model	Page	Model	Page
55RNAL-6T-4	21	75NAL-2V-4	21	937445PT	53	SBA-12	61
55RNL-2T-4	23	75NL-2V-4	23	937446PT	53	SBA-12-AH	61
55RNL-3T-4	23	75NL-2X-6	23	937446PT	53	SBA-18	61
55RNL-7T-4	23	75NL-3V-4	23	937447PT	53	SBA-18-AH	61
60NDR092HD24	44	75RNAL-2V-4	21	937447PT	53	SBA-24-AH	61
60NDR092HD40	44	75RNAL-2X-6	21	937448PT	53	SBA-30-AH	61
60NDR092HD48	44	75RNAL-3V-4	21	937448PT	53	SBA-30-WM	61
60NDR092HD56	44	75RNAL-3X-6	21	937449PT	53	SW-102	63
64TTK110D4	27	75RNL-2X-6	23	937449PT	53	SW-103	63
64TTK125D4	27	75RNL-3V-4	23	937450PT	53	SW-104	63
64TTK1260D8	27	75RNL-3X-6	23	937450PT	53	SWR-102	63
64TTK140D4	27	7PHH602	52	937451PT	53	TVP-110-15-D	38
64TTK1475D8	27	7PHH60Q	52	937451PT	53	TVP-110-15-P	38
64TTK150D6	27	7PTHH352	51	A139856	63	TVP-110-15-S	38
64TTK175D6	27	7PTHH35Q	51	BL-2A	13,59	TVP-110-15-U	38
64TTK1820D8	27	7STHFA55Q	51	BL-4A	13,59	TVP-110-30-D	38
64TTK1985D8	27	7STHFC55Q	51	BL-6A	59	TVP-110-30-P	38
64TTK205D6	27	80PHH604	52	BL-8A	59	TVP-110-30-S	38
64TTK255D6	27	80PHH60Q	52	BLL-6A	59	TVP-110-30-U	38
64TTK345D6	27	80PTHH354	51	BLL-8A	59	W-2109-8	57
64TTK34D4	27	80PTHH35Q	51	BM-13A	59	W-2120-12	57
64TTK3850D12	27	88RSA-5C-3	7	BM-18A	59	WL-200-3	57
64TTK425D6	27	88RSA-5CQ	7	BM-25A	59	WL-200-4	57
64TTK44D4	27	88RSA-7C-3	7	BM-35A	59	WP-2049-6	57
64TTK55D4	27	88RSA-7CQ	7	BM-45A	59	WP-2050-6	57
64TTK570D6	27	88RSAL-5C-3	7	BML-13A	59	WP-2059-6	57
64TTK640D8	27	88RSAL-5CQ	7	CPBA-12-AH	61	WP-2059-8	57
64TTK750D8	27	88RSAPT-2CQ	10	CPBA-18	61	WP-2059-8-6E	57
64TTK75D4	27	88RSAPT-5C-3	10	CPBA-18-AH	61	WP-2060B-6	57
64TTK90D4	27	88RSAPT-5CQ	10	CPBA-30	61	WP-2060B-8	57
64TTK930D8	27	88RSAPT-7CQ	10	CPBA-30-AH	61	WP-2109B-8	57
64TTS110D4	27	88RSATP-2C-3	10	CPBA-30-WM	61	WP-2110B-8	57
64TTS125D4	27	88RSATP-2CQ	10	CSBA-12-AH	61	WP-255-3P	57
64TTS1260D8	27	88RSATP-5C-3	10	CSBA-18-AH	61	WP-455-4P	57
64TTS140D4	27	88RSATP-5CQ	10	CSBA-24	61	WP-455-4R	57
64TTS1475D8	27	88RSATP-7C-3	10	CSBA-30	61	WPS-2109B	57
64TTS150D6	27	88RSATP-7CQ	10	CSBA-30-AH	61	WS-2119	57
64TTS175D6	27	88SA-5C-3	7	CSBA18	61	WT-2109-8	57
64TTS1820D8	27	88SA-5CQ	7	H16NDR09H15	44	WT-2110-8	57
64TTS1985D8	27	88SA-7CQ	7	H16NDR09H20	44	WT-2119-12	57
64TTS205D6	27	8RNP-10BQ	11	H30NDR08H15	44	WT-2120-12	57
64TTS255D6	27	8RNP-20BQ	11	H30NDR08H16	44	WTS-2109	57
64TTS345D6	27	8RSA-10	7	H30NDR08H18	44	WTS-2119	57
64TTS34D4	27	8RSA-10BQ	7	H30NDR08H20	44	WTS-2120	57
64TTS3850D12	27	8RSA-5BQ	7	H30NDR08H25	44		
64TTS425D6	27	8RSA-7BQ	7	PBA-12	61		
64TTS44D4	27	8RSAL-10BQ	7	PBA-12-AH	61		
64TTS55D4	27	936695PT	53	PBA-12-WM	61		
64TTS570D6	27	937442PT	53	PBA-18	61		
64TTS640D8	27	937442PT	53	PBA-18-18-AH	61		
64TTS750D8	27	937443PT	53	PBA-18-AH	61		
64TTS75D4	27	937443PT	53	PBA-24	61		
64TTS90D4	27	937444PT	53	PBA-24-AH	61		
64TTS930D8	27	937444PT	53	PBA-30-AH	61		
75 NAL-2X-6	21	937445PT	53	PL-12A	13,59		

Applifast.



251 Cree Crescent, Winnipeg, MB Canada R3J 3X4
Tel: 204 837 8361 • 1 800 563 1293
info@applifast.com



applifast.com